

Appendix A

Best Management Practices (BMPs)

- Appendix A1 – Construction Site Planning and Management
- Appendix A2 – Erosion Control
- Appendix A3 – Runoff Control
- Appendix A4 – Sediment Control
- Appendix A5 – Good Housekeeping/Materials Management
- Appendix A6 – Post-Construction Phase BMPs

(This page intentionally blank)

Best Management Practices (BMPs)

(This page intentionally blank)

INTRODUCTION

In selecting the best management practices (BMPs) to be incorporated into a Storm Water Pollution Prevention Plan (SWPPP), the user must understand the causes of pollution. Again, the three goals of the National Pollutant Discharge Elimination System (NPDES) storm water program are to reduce erosion, minimize sedimentation, and control the discharge of non-storm water pollutants. Understanding how these processes occur will help the user choose the best BMPs to use on a site.

Two types of erosion can occur: surface erosion and stream erosion. Surface erosion is caused by the impact of raindrops on the soil and the very shallow sheet flow at low velocities across the soil. Surface erosion is best controlled using stabilization practices, minimizing the area disturbed (including tree/brush/vegetative clearing and grubbing), and minimizing the time disturbed areas are exposed. Minimizing the surface erosion results in less sedimentation to be dealt with in storm water leaving the site. Stream erosion occurs when water collects and moves through rills, gullies, and channels, which can develop and be caused or enlarged by the concentrated flow. Stream erosion is usually controlled using structural controls or leveling. The key to reducing stream erosion is to reduce the velocity of the flow.

This manual also provides information regarding the development of SWPPPs, as well as application of BMPs for construction sites. This manual describes many BMPs in detail. The user must use careful consideration when selecting or modifying BMPs for a specific site. Many of the suggested BMPs are general in nature, and their applicability should be evaluated for each specific project site. The suggested BMPs should be used only as a guide, and should not substitute for good engineering judgment.

In all areas, training for people using this or other manuals should be provided by some responsible entity related to storm water management. In New Mexico, training is presently provided by the New Mexico Association of General Contractors. This manual, or the one like it developed by the North Central Texas Council of Governments, is suitable for use as a basis for such training.

(This page intentionally blank)

Appendix A1

Construction Site Planning and Management

- Dust Control
- Protection of Trees
- Open Space Design
- Protection of Natural Features

(This page intentionally blank)

Construction Site Planning and Management

(This page intentionally blank)

Construction Site Planning and Management

CONTENTS

| BMP | Page |
|--------------------------------------|-------------|
| Symbols | A1-2 |
| Dust Control | A1-3 |
| Protection of Trees | A1-5 |
| Open Space Design | A1-7 |
| Protection of Natural Features | A1-9 |

SYMBOLS

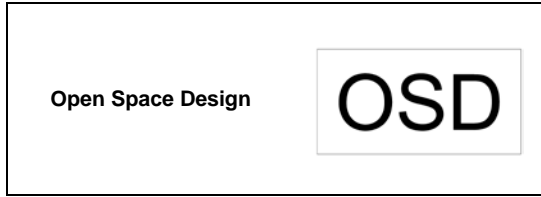

| Dust Control | Applications |
|---|---|
| <p>DESCRIPTION</p> <p>A comprehensive dust control plan is used to limit offsite sedimentation by controlling the sites potential for producing airborne fugitive dust and track-out of sediments.</p> <p>Sediments that are transported from construction sites by storm water runoff, wind, erosion and vehicle trackout are often re-dispersed to the air by subsequent vehicular traffic and high winds. Likewise, these sediments may be transported by the next rainfall into public storm sewer systems. Implementation of control measures to minimize the generation of fugitive dust from construction sites will also limit the quantity of sediments in storm water.</p> | <p>Perimeter Control</p> <p>Slope Protection</p> <p>✓ Sediment Trapping</p> <p>Channel Protection</p> <p>✓ Temporary Stabilization</p> <p>Permanent Stabilization</p> <p>Waste Management</p> <p>Housekeeping Practices</p> |
| <p>APPLICATIONS</p> <p>Primary sources of dust from development and construction activities are:</p> <ul style="list-style-type: none"> • Grading Operations (land clearing and earthmoving) • Drilling and blasting • Batch drop operations (loader operation) • Exposed areas, cleared unstabilized areas • Vehicle traffic on unpaved surfaces • Sediment tracking on paved surfaces • Blasting and wrecking ball operations • Soil and debris storage piles | <p>Targeted Constituents</p> <p>✓ Sediment</p> <p>Nutrients</p> <p>Toxic Materials</p> <p>Oil and Grease</p> <p>Floatable Materials</p> <p>Construction Wastes</p> |
| <p>The contractor is responsible for complying with the requirements of the air pollution control permit, if required. The approach to reduce air pollution from construction sites should require:</p> <ul style="list-style-type: none"> • Dust control plans for construction or land-clearing projects • Enforcement activities with priority given to citizen complaints • Maintenance of records by contactors | <p>Impact</p> <p>✓ Significant</p> <p>✓ Medium</p> <p>Low</p> <p>Unknown or Questionable</p> |
| <p>Many of the reasonably available control measures for controlling fugitive dust from construction sites can also be implemented as BMPs for storm water pollution prevention. The following BMPs can be used:</p> <ul style="list-style-type: none"> • Pave, vegetate, or chemically stabilize access points to paved roads. • Provide covers for trucks transporting materials that contribute dust. | |

| Dust Control | Applications |
|---|---|
| <p>DESCRIPTION</p> <p>A comprehensive dust control plan is used to limit offsite sedimentation by controlling the sites potential for producing airborne fugitive dust and track-out of sediments.</p> <p>Sediments that are transported from construction sites by storm water runoff, wind, erosion and vehicle trackout are often re-dispersed to the air by subsequent vehicular traffic and high winds. Likewise, these sediments may be transported by the next rainfall into public storm sewer systems. Implementation of control measures to minimize the generation of fugitive dust from construction sites will also limit the quantity of sediments in storm water.</p> | <p>Perimeter Control</p> <p>Slope Protection</p> <p>✓ Sediment Trapping</p> <p>Channel Protection</p> <p>✓ Temporary Stabilization</p> <p>Permanent Stabilization</p> <p>Waste Management</p> <p>Housekeeping Practices</p> |
| <p>APPLICATIONS</p> <p>Primary sources of dust from development and construction activities are:</p> <ul style="list-style-type: none"> • Grading Operations (land clearing and earthmoving) • Drilling and blasting • Batch drop operations (loader operation) • Exposed areas, cleared unstabilized areas • Vehicle traffic on unpaved surfaces • Sediment tracking on paved surfaces • Blasting and wrecking ball operations • Soil and debris storage piles | <p>Targeted Constituents</p> <p>✓ Sediment</p> <p>Nutrients</p> <p>Toxic Materials</p> <p>Oil and Grease</p> <p>Floatable Materials</p> <p>Construction Wastes</p> |
| <p>The contractor is responsible for complying with the requirements of the air pollution control permit, if required. The approach to reduce air pollution from construction sites should require:</p> <ul style="list-style-type: none"> • Dust control plans for construction or land-clearing projects • Enforcement activities with priority given to citizen complaints • Maintenance of records by contactors | <p>Impact</p> <p>✓ Significant</p> <p>✓ Medium</p> <p>Low</p> <p>Unknown or Questionable</p> |
| <p>Many of the reasonably available control measures for controlling fugitive dust from construction sites can also be implemented as BMPs for storm water pollution prevention. The following BMPs can be used:</p> <ul style="list-style-type: none"> • Pave, vegetate, or chemically stabilize access points to paved roads. • Provide covers for trucks transporting materials that contribute dust. | |

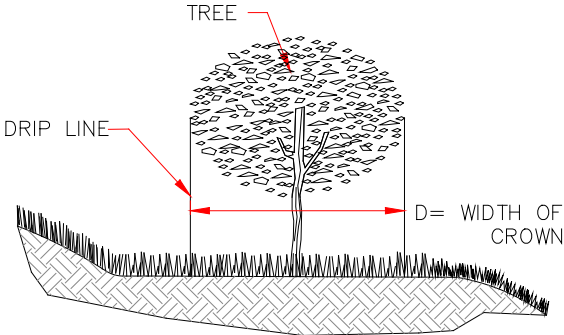
| <h2 style="text-align: center;">Protection of Trees</h2> | |
|---|--|
| <p>DESCRIPTION</p> <p>Trees can provide superior, low-maintenance, and long-term erosion protection. They are also useful for site aesthetics.</p> <p>PRIMARY USE</p> <p>Preserving and protecting trees can result in a more stable and aesthetically pleasing development. Trees stabilize the soil and help prevent erosion, decrease storm water runoff, moderate temperatures, provide buffers and screens, filter pollutants from the air, supply oxygen, provide wildlife habitat, and increase property values.</p> <p>APPLICATIONS</p> <p>Trees are desirable on steep or rocky slopes where mowing is not feasible; where ornamentals are desired for landscaping purposes; and where woody plants are desired for soil conservation or for establishment or maintenance of wildlife habitats.</p> <p>NOTES</p> <ul style="list-style-type: none"> • Mark trees to be protected at a height visible to equipment operators. • Equipment operators shall not clean their equipment by slamming it against the protected trees. • Roots, trunk, and tops of trees can be protected by fencing. The fence shall be erected at the tree drip line. • Limits for clearing must be located at the tree drip line. • Trenching shall always be performed as far away from trees as possible. Consider tunneling as an option. • Damaged trees should be repaired. Appropriate repairs should be prescribed by a forester or a tree specialist. | <p style="text-align: center;">Applications</p> <p>Perimeter Control</p> <p>✓ Slope Protection</p> <p>Sediment Trapping</p> <p>Channel Protection</p> <p>✓ Temporary Stabilization</p> <p>✓ Permanent Stabilization</p> <p>Waste Management</p> <p>Housekeeping Practices</p> |
| | <p style="text-align: center;">Targeted Constituents</p> <p>Sediment</p> <p>Nutrients</p> <p>Toxic Materials</p> <p>Oil and Grease</p> <p>Floatable Materials</p> <p>Construction Wastes</p> |
| | <p style="text-align: center;">Impact</p> <p>✓ Significant</p> <p>✓ Medium</p> <p>Low</p> <p>Unknown or Questionable</p> |
| <div style="text-align: center;">  </div> | |

(This page intentionally blank)

| | |
|---|---|
| <h2 style="text-align: center;">Open Space Design</h2> <div style="text-align: center;"> <p style="text-align: center;">AS DENSITY IS HELD CONSTANT, LOT SIZE IS REDUCED, DISTURBED AREA IS DECREASED, AND UNDISTURBED OPEN SPACE IS INCREASED.</p> </div> | <h3 style="text-align: center;">Applications</h3> <ul style="list-style-type: none"> Perimeter Control Slope Protection ✓ Sediment Trapping Channel Protection ✓ Temporary Stabilization ✓ Permanent Stabilization Waste Management Housekeeping Practices |
| <h3>DESCRIPTION</h3> <p>Open space design, also known as conservation development or cluster development, is a better site design technique that concentrates dwelling units in a compact area in one portion of the development site in exchange for providing open space and natural areas elsewhere on the site. Open space designs have many benefits in comparison to the conventional subdivisions that they replace: they can reduce impervious cover, stormwater pollutants, construction costs, grading, and the loss of natural areas.</p> <h3>PRIMARY USE</h3> <p>Open space design is widely applicable to most forms of residential development. The greatest stormwater and pollutant reduction benefits typically occur when open space design is applied to residential zones that have larger lots. In these types of large lot zones, a great deal of natural or community open space can be created by shrinking lot sizes.</p> <h3>APPLICATIONS</h3> <p>Open space design can be employed in nearly all geographic regions of the country, with the result of different types of open space being conserved (forest, prairie, farmland, chaparral, or desert).</p> <h3>LIMITATIONS</h3> <p>Many communities lack zoning ordinances to permit open space development, and even those that have enacted ordinances might need to revise them to achieve greater water quality and environmental benefits.</p> <h3>MAINTENANCE REQUIREMENTS</h3> <p>Once established, common open space and natural conservation areas must be managed by a responsible party able to maintain the areas in a natural state in perpetuity.</p> | <h3>Targeted Constituents</h3> <ul style="list-style-type: none"> ✓ Sediment ✓ Nutrients Toxic Materials ✓ Oil and Grease Floatable Materials Construction Wastes <h3>Impact</h3> <ul style="list-style-type: none"> ✓ Significant ✓ Medium Low Unknown or Questionable |
| | <div style="border: 1px solid black; padding: 20px; width: 100px; margin: 0 auto;"> <h1 style="margin: 0;">OSD</h1> </div> |

(This page intentionally blank)

| | |
|---|---|
| <p>Protection of Natural Features</p>  | <p>Applications</p> <ul style="list-style-type: none"> Perimeter Control Slope Protection ✓ Sediment Trapping ✓ Channel Protection Temporary Stabilization ✓ Permanent Stabilization Waste Management Housekeeping Practices |
| <p>DESCRIPTION</p> <p>Undeveloped sites can have numerous natural features that provide environmental, aesthetic, and recreational benefits if preserved and protected from the impacts of construction and development. These features include wetlands, riparian areas, floodplains, aquifer recharge areas, mature trees, woodlands, and other wildlife habitat. Restricted areas such as floodplains and steep slopes should also be protected from possible impacts from construction activities.</p> <p>PRIMARY USE</p> <p>Protection of Natural Features is utilized to identify and preserve portions of properties that are being developed or redeveloped that might have attractive open space, well-drained soils, or riparian areas.</p> <p>APPLICATIONS</p> <p>Developments can be planned around significant environmental features, which can then be marketed as amenities.</p> <p>LIMITATIONS</p> <p>Local zoning codes might restrict the use of clustering, reduced road widths, and other techniques for natural area preservation. Developers should work with local regulatory agencies to determine whether they can obtain waivers to protect natural features.</p> <p>MAINTENANCE REQUIREMENTS</p> <p>Once established, common open space and natural conservation areas must be managed by a responsible party able to maintain the areas in a natural state in perpetuity.</p> | <p>Targeted Constituents</p> <ul style="list-style-type: none"> ✓ Sediment Nutrients Toxic Materials ✓ Oil and Grease Floatable Materials Construction Wastes <p>Impact</p> <ul style="list-style-type: none"> Significant ✓ Medium Low Unknown or Questionable |
| | <div style="border: 1px solid black; padding: 10px; text-align: center; width: 100px; margin: 0 auto;"> <p>PNF</p> </div> |

(This page intentionally blank)

Appendix A2

Erosion Control

- Seeding – Temporary/Vegetation
- Mulching
- Surface Roughening
- Erosion Control Mat
- Land Imprinting

(This page intentionally blank)

Erosion Control





(This page intentionally blank)

Erosion Control

CONTENTS

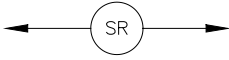
| BMP | Page |
|--------------------------------------|-------------|
| Symbols | A2-2 |
| Seeding – Temporary/Vegetation | A2-3 |
| Mulching..... | A2-5 |
| Surface Roughening..... | A2-7 |
| Erosion Control Mat..... | A2-9 |
| Land Imprinting..... | A2-11 |

SYMBOLS

| | |
|---|---|
| <p>Seeding - Temporary</p>  | <p>Surface Roughening</p>  |
| <p>Mulching</p>  | <p>Erosion Control Mat</p>  |
| <p>Land Imprinting</p>  | |

| Seeding – Temporary/Vegetation | |
|--|--|
| <p>DESCRIPTION</p> <p>As a BMP, temporary seeding/vegetation is used to establish a temporary vegetative cover on disturbed areas by seeding with appropriate rapidly growing annual vegetation, annual grasses, small grains, or legumes. This short-term vegetative area will reduce erosion and sedimentation on disturbed areas that will not be permanently stabilized within an acceptable period of time. Temporary seeding will also reduce problems associated with mud and dust from construction activities on bare, unprotected soil surfaces.</p> <p>PRIMARY USE</p> <p>Temporary seeding should be considered for disturbed areas that will not be permanently stabilized or have work performed thereon for a period of 21 days or more. Such areas include denuded areas, soil stockpiles, dikes, berms, temporary embankments, excavation slopes, etc. As a temporary control, vegetation is used to stabilize stockpiles and barren areas that are inactive for long periods of time. As a permanent control, grasses and other vegetation provide good protection for the soil, along with some filtering for overland runoff. Subjected to acceptable runoff velocities, vegetation can provide a good method of permanent storm water management, as well as a visual amenity to the site.</p> <p>Other BMPs may be required to assist in the establishment of vegetation. These other techniques include erosion control matting; swales and dikes to direct flow around newly seeded areas; and proper grading to limit runoff velocities during construction.</p> <p>APPLICATIONS</p> <p>Planting should take place when conditions are most favorable for growth (as long as the planting does not interfere with the schedule of other activities and/or regulatory requirements). Before seeding, other erosion control practices such as dikes, basins, and surface runoff-control measures (e.g., interceptor dikes and swales, etc.) should be installed. Temporary bale barriers and silt fences may have to be placed/replaced after seeding operations, since they may get in the way of the machinery. However, use common sense to coordinate operations to maximize the effectiveness of the erosion control measures. Temporary seeding may not be an effective practice in arid and semi-arid regions where the climate prevents fast plant establishment. In those areas, or when seasonal planting restrictions prohibit, temporary mulching may be better for the short term.</p> <p>For further information, refer to Section 632 of <i>Standard Specifications for Highway and Bridge Construction</i> (New Mexico State Highway and Transportation Department [NMSHTD] 2000).</p> | <p style="text-align: center;">Applications</p> <p>Perimeter Control</p> <ul style="list-style-type: none"> ✓ Slope Protection ✓ Sediment Trapping ✓ Channel Protection ✓ Temporary Stabilization ✓ Permanent Stabilization <p>Waste Management</p> <p>Housekeeping Practices</p> <hr/> <p style="text-align: center;">Targeted Constituents</p> <ul style="list-style-type: none"> ✓ Sediment Nutrients Toxic Materials Oil and Grease Floatable Materials Construction Wastes <hr/> <p style="text-align: center;">Impact</p> <ul style="list-style-type: none"> ✓ Significant Medium Low Unknown or Questionable <hr/> <div style="text-align: center;">  </div> |

Seeding – Temporary/Vegetation (continued)

All seeded areas should be covered with mulch to provide protection from the weather. Frequent inspections are necessary to check that conditions for growth are good. If the plants do not grow quickly or thick enough to prevent erosion, the area should be reseeded as soon as possible.

Temporary seed selection should take into account the season and location. Specific seed mixes can usually be found in the construction plans. The plans and specifications should reflect temporary seeding locations, quantities, and pay items. For suggested seed types, see Appendix D, Guidance on Seed Selection and Seeding of Temporary Vegetation on Disturbed Areas.

Native grasses should not be used for temporary seeding. Irrigation or a temporary watering facility should be provided. Seed should be selected in accordance with local Natural Resources Conservation Service (NRCS) rules.

Vegetative techniques can and should apply to every construction project, with few exceptions. Vegetation effectively reduces erosion in swales, stockpiles, berms, mild to medium slopes, and along roadways. Vegetative strips can provide some protection when used as a perimeter control for utility and site development construction.

Surface Preparation



- Interim or final grading must be completed prior to seeding, minimizing all steep slopes.
- Install all necessary erosion structures such as dikes, swales, diversions, etc., prior to seeding.
- Groove or furrow slopes steeper than 3:1 on the contour line before seeding.
- Provide 4-6 inches of topsoil over rock, gravel, or otherwise unsuitable soils.
- Seedbed should be well pulverized, loose, and uniform.

Plant Selection, Fertilization and Seeding

- Use only high quality, U.S. Department of Agriculture (USDA)-certified seed.
- Use an appropriate species or species mixture adapted to local climate, soil conditions, and season. Consult with the local NRCS office or local County Extension Service as necessary for selection of proper species and application techniques in the area. Seeding rate should be in accordance with recommendations by the NRCS or Engineering Extension Service.
- Fertilizer shall be applied according to the manufacturer's recommendation with proper spreader equipment. Typical application rate for 10-10-10 grade fertilizer is 700-1000 lb/acre. DO NOT OVER APPLY FERTILIZER.
- If hydro-seeding is used, do not mix seed and fertilizer more than 30 minutes before application.
- Evenly apply seed using cyclone seeder, seed drill, cultipacker, or hydroseeder.
- Provide adequate water to aid in establishment of vegetation.
- Use appropriate mulching techniques where necessary.

| Mulching | Applications |
|--|---|
| <p>DESCRIPTION</p> <p>Mulching is used to provide a stabilized surface for seeding or to prevent erosion using chemical soil stabilizers and a variety of organic or inorganic materials, netting, or mats.</p> <p>PRIMARY USE</p> <p>Mulching is used to prevent erosion by creating a permanent material to slow surface velocity, trap sediment, and protect surface areas around structures.</p> <p>APPLICATIONS</p> <p>Mulching is used in areas where permanent velocity control and sediment trapping will be required. Follow Section 632, pp. 684-685 of <i>Standard Specifications for Highway and Bridge Construction</i> (NMSHTD 2000).</p> <p>NOTES</p> <ul style="list-style-type: none"> • Hay should consist of native grasses free of noxious weed seeds (certified weed-free hay or straw may be required in designated areas of the state). • Straw should consist of clean cereal shafts. • Hay and straw mulch should be spread at a rate of 1.5 to 2 tons per acre. • At a minimum, 65% of the mulch, by weight, should be 10 inches or more in length. • Applied mulch depth should not be less than 1 inch and not more than 2 inches. The mulch should be uniformly applied so that no more than 10% of the soil surface is exposed. • Hay and straw mulch should be anchored to the soil surface using tackifiers, blankets, or nets, or with a mulch-crimping machine. Mechanical anchoring, or crimping, is preferred and recommended for slopes flatter than 2:1. Blankets or nets on slopes steeper than 2:1 should be anchored to the soil. • Tackifiers (for anchoring) should consist of a free-flowing non-corrosive powder. This material shall not contain any mineral filler, recycled cellulose fiber, clays, or other substances that may inhibit germination or growth of plants. • Tackifiers (for anchoring) shall be applied in a slurry with water and wood fiber (100 lbs of powder and 150 lbs of fiber per 700 gallons of water). Application rate of powder should be between 80 and 200 lbs per acre. | <p>Perimeter Control</p> <p>✓ Slope Protection</p> <p>✓ Sediment Trapping</p> <p>Channel Protection</p> <p>✓ Temporary Stabilization</p> <p>Permanent Stabilization</p> <p>Waste Management</p> <p>Housekeeping Practices</p> <p>Targeted Constituents</p> <p>✓ Sediment</p> <p>✓ Nutrients</p> <p>Toxic Materials</p> <p>Oil and Grease</p> <p>Floatable Materials</p> <p>Construction Wastes</p> |
| | <p>Impact</p> <p>✓ Significant</p> <p>✓ Medium</p> <p>Low</p> <p>Unknown or Questionable</p> |
| | <p style="text-align: center;">  </p> |

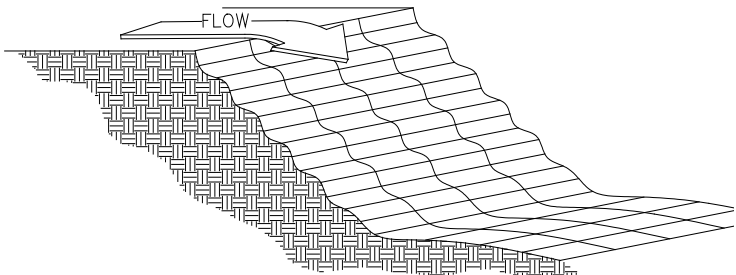
(This page intentionally blank)

| | |
|--|---|
| <p>Surface Roughening</p>  | <p>Applications</p> <ul style="list-style-type: none"> Perimeter Control ✓ Slope Protection ✓ Sediment Trapping Channel Protection ✓ Temporary Stabilization Permanent Stabilization Waste Management Housekeeping Practices |
| <p>DESCRIPTION</p> <p>Surface roughening provides a rough soil surface with horizontal depressions created on the contour, leaving slopes in a roughened condition by not fine grading them.</p> <p>PRIMARY USE</p> <p>Surface roughening is used to slow surface flow and to allow material and water deposition in steps, which encourages plant growth.</p> <p>APPLICATIONS</p> <p>Surface roughening is used on steep slopes prior to or in conjunction with seeding or mulching; on slopes where seeding and mulching cannot be accomplished due to wrong season or lack of water.</p> <p>NOTES</p> <ul style="list-style-type: none"> • Horizontal depressions must be created approximately 2-4 inches deep, and spaced 4-6 inches apart. • Use stair-step grading, grooving, or tracking. • Roughening of ridges and depressions should follow along the contours of the slope. • Use machinery to create a series of ridges and depressions that run perpendicular to the slope (on the contour). Operate the machinery up and down the slope to leave horizontal depressions in the soil. Make as few passes as possible to minimize compaction. • Seed and mulch roughened areas as soon as possible. • Do not drive vehicles or equipment over areas that have been roughened. | <p>Targeted Constituents</p> <ul style="list-style-type: none"> ✓ Sediment Nutrients Toxic Materials Oil and Grease Floatable Materials Construction Wastes |
| | <p>Impact</p> <ul style="list-style-type: none"> Significant ✓ Medium Low Unknown or Questionable |
| |  |

Surface Roughening (continued)

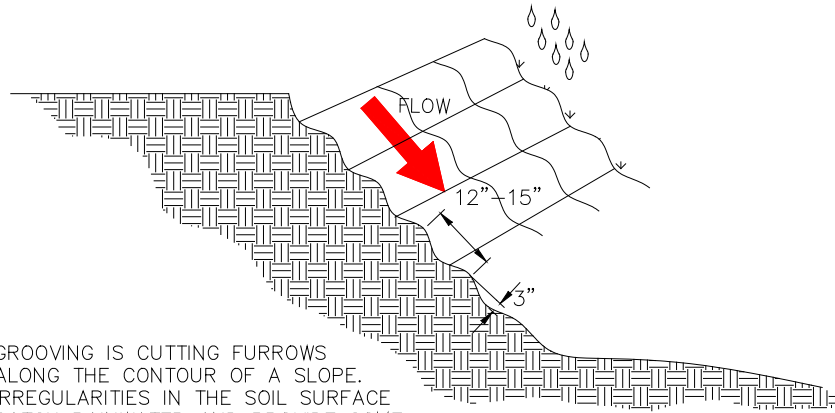

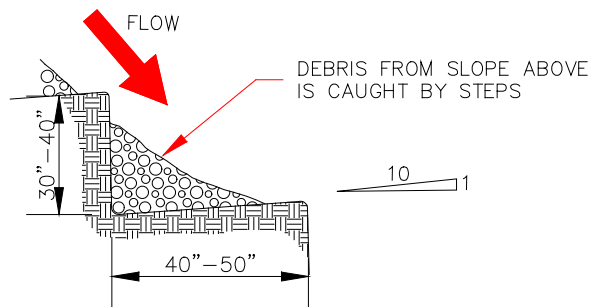
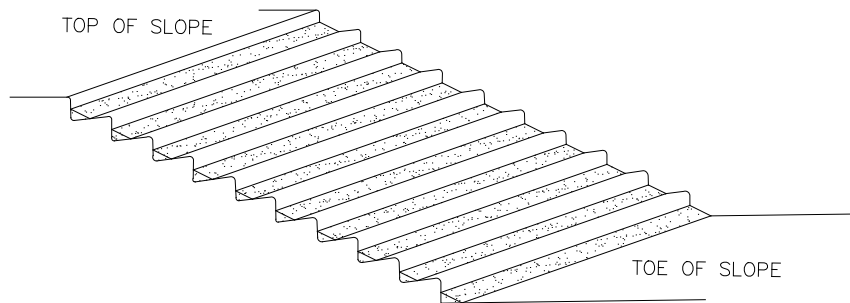

GROOVING IS CUTTING FURROWS ALONG THE CONTOUR OF A SLOPE. IRREGULARITIES IN THE SOIL SURFACE CATCH RAINWATER AND PROVIDE SOME RETENTION OF LIME, FERTILIZER AND SEED.

GROOVING SLOPES

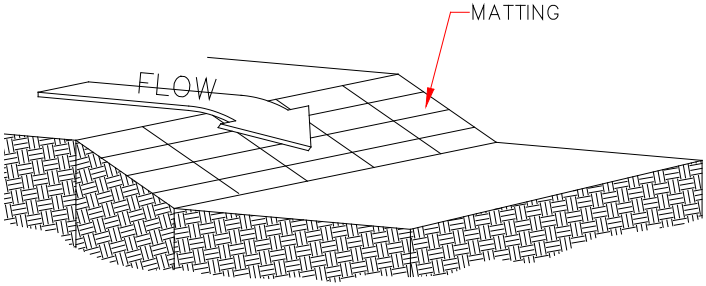

STAIR STEPPING CUT SLOPE

| | |
|--|---|
| <p>Erosion Control Mat</p>  | <p>Applications</p> <ul style="list-style-type: none"> Perimeter Control ✓ Slope Protection ✓ Sediment Trapping Channel Protection ✓ Temporary Stabilization ✓ Permanent Stabilization Waste Management Housekeeping Practices |
| <p>DESCRIPTION</p> <p>Organic or synthetic erosion control matting is placed on disturbed areas or slopes to aid in erosion control and to promote the establishment of vegetative cover.</p> <p>PRIMARY USE</p> <p>Erosion control mats provide either temporary or permanent stabilization for barren or disturbed areas on steep slopes, drainage swales, embankments, or high-traffic areas.</p> <p>APPLICATIONS</p> <p>Erosion control mats can be used in any construction-related disturbed area; areas with fine-grained soils; short steep slopes; or where vegetation growth is slow.</p> <p>See, for instance, Class 'D' seeding and geotextiles, Section 604, p. 618 in <i>Standard Specifications for Highway and Bridge Construction</i> (NMSHTD 2000).</p> | <p>Targeted Constituents</p> <ul style="list-style-type: none"> ✓ Sediment Nutrients Toxic Materials Oil and Grease Floatable Materials Construction Wastes <p>Impact</p> <ul style="list-style-type: none"> ✓ Significant Medium Low Unknown or Questionable |
| |  |

(This page intentionally blank)

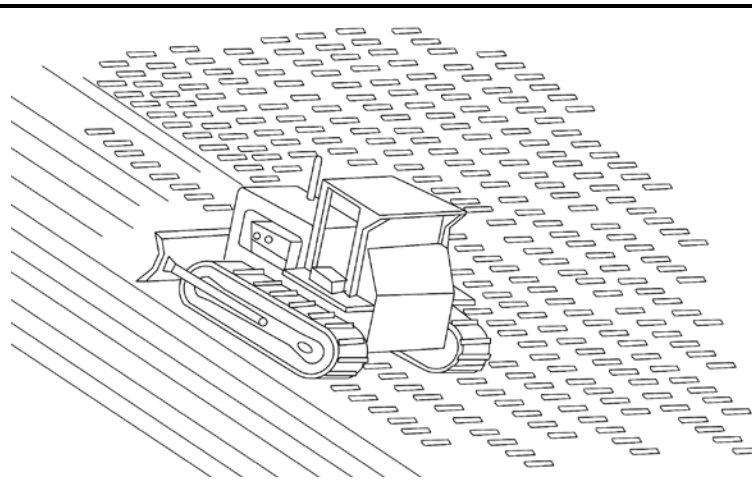
| | |
|--|---|
| <p>Land Imprinting</p>  | <p>Applications</p> <ul style="list-style-type: none"> Perimeter Control Slope Protection ✓ Sediment Trapping Channel Protection ✓ Temporary Stabilization ✓ Permanent Stabilization Waste Management Housekeeping Practices |
| <p>DESCRIPTION</p> <p>Land Imprinting is an erosion control practice used in conjunction with final grading, seeding, and revegetation. Land Imprinting involves increasing the relief of a bare soil surface with horizontal grooves by mechanical equipment to track the surface.</p> <p>PRIMARY USE</p> <p>Land Imprinting reduces runoff velocity, increases infiltration, reduces erosion, traps sediment, and prepares the soil for seeding and planting by giving seed an opportunity to take hold and grow and providing pocket depressions which provide: protection from wind erosion and micro-areas of moisture accumulation.</p> <p>APPLICATIONS</p> <p>Soil roughening is appropriate for all slopes, but works especially well on slopes greater than 3:1, on piles of excavated soil, and in areas with highly erodible soils. Use this practice in conjunction with seeding, planting, and temporary mulching to stabilize an area. A combination of surface roughening and vegetation is appropriate for steeper slopes and slopes that will be left bare for longer periods of time.</p> <p>LIMITATIONS</p> <p>Soil roughening is not appropriate for rocky slopes or very fine sands. Tracked machinery can excessively compact the soil. Typically, soil roughening is effective only for gentle or shallow depth rains.</p> <p>MAINTENANCE REQUIREMENTS</p> <p>Inspections should be made on a monthly basis. If roughening is washed away in a heavy storm, re-roughen the surface and reseed.</p> | <p>Targeted Constituents</p> <ul style="list-style-type: none"> ✓ Sediment Nutrients Toxic Materials Oil and Grease Floatable Materials Construction Wastes |
| | <p>Impact</p> <ul style="list-style-type: none"> Significant ✓ Medium Low Unknown or Questionable |
| | <div style="border: 1px solid black; width: 100px; height: 100px; display: flex; align-items: center; justify-content: center; margin: 0 auto;"> LI </div> |

(This page intentionally blank)

Appendix A3

Runoff Control

- Diversion Channel Dike and Swale
- Slope Drain
- Check Dam
- Bioretention
- Brush Barrier
- Detention Basin
- Fiberschines/Biologs
- Wood Chip Bern
- Toe Rock
- Outlet Structure
- Guardrail End Treatment

(This page intentionally blank)

Runoff Control







(This page intentionally blank)

Runoff Controls

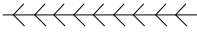
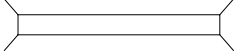
TABLE OF CONTENTS

| BMP | Page |
|--|-------------|
| Symbols | A3-2 |
| Diversion Channel Dike and Swale | A3-3 |
| Slope Drain..... | A3-7 |
| Check Dam..... | A3-9 |
| Brioretention | A3-13 |
| Brush Barrier | A3-15 |
| Detention Basin | A3-17 |
| Fiberschines/Biologs | A3-19 |
| Wood Chip Berm | A3-21 |
| Toe Rock..... | A3-23 |
| Outlet Structure | A3-25 |
| Guardrail End Treatment..... | A3-27 |

SYMBOLS

| | |
|--|--|
| <p>Diversion Channel Dike and Swale</p>  <p>ED</p>  <p>DC</p> | <p>Slope Drain</p>  |
| <p>Check Dam</p>  <p>CD</p> | <p>Bioretention</p> <p>BR</p> |
| <p>Brush Barrier</p>  | <p>Detention Basin</p> <p>DB</p> |
| <p>Fiberschines/Biologs</p>  | <p>Wood Chip Berm</p>  |
| <p>Toe Rock</p>  | <p>Outlet Structure</p> <p>OS</p> |
| <p>Guardrail Treatment</p>  | |

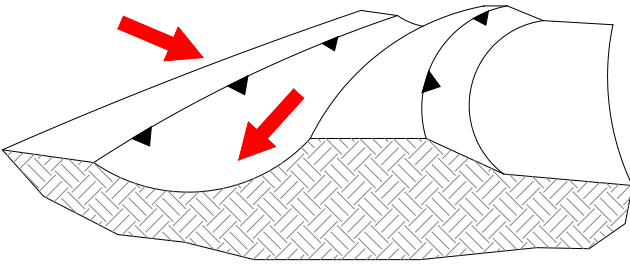
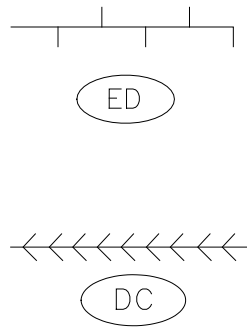
| | |
|---|---|
| <p>Diversion Channel Dike and Swale</p>  <p>TYPICAL SWALE CONFIGURATION</p> | <p>Applications</p> <ul style="list-style-type: none"> ✓ Perimeter Control ✓ Slope Protection Sediment Trapping Channel Protection Temporary Stabilization Permanent Stabilization Waste Management Housekeeping Practices |
| <p>DESCRIPTION</p> <p>Diversion channel dikes and swales are constructed conveyances that concentrate and route flow away from construction areas or toward certain locations, treatments, or BMP locations.</p> <p>PRIMARY USE</p> <p>Diversion channels can be used to direct sediment-laden flow into a controlled outlet, or to clean flow around disturbed areas.</p> <p>APPLICATIONS</p> <p>Dikes and swales are useful when significant offsite flow could disturb a site; when flow needs to be directed away from staging, storage, or fueling areas; or where routing is required to treatment.</p> <p>LIMITATIONS</p> <p><i>Earth Dike (Berm)</i></p> <p>Compacted earth dikes require stabilization immediately upon placement so as not to contribute to the problem they are addressing.</p> <p>The diversion dikes can be a hindrance to construction equipment moving on the site; therefore, their locations must be carefully planned prior to installation.</p> <p><i>Diversion Channel (Swale)</i></p> <p>Interceptor swales must be stabilized quickly upon excavation so as not to contribute to the erosion problem they are addressing.</p> <p>Swales may be unsuitable to the site conditions (too flat or steep).</p> <p>Limited flow capacity for temporary swales. For permanent swales, the 1.5-foot maximum depth can be increased as long as provisions for public safety are implemented.</p> | <p>Targeted Constituents</p> <ul style="list-style-type: none"> ✓ Sediment Nutrients Toxic Materials Oil and Grease ✓ Floatable Materials Construction Wastes <p>Impact</p> <ul style="list-style-type: none"> ✓ Significant ✓ Medium Low Unknown or Questionable |
| |  |

Diversion Channel Dike and Swale (continued)

MAINTENANCE REQUIREMENTS

Earth Dike (Berm)

Dikes must be inspected on a weekly basis and after each significant (>0.5 inch) rainfall to determine if silt is building up behind the dike, or if erosion is occurring on the face of the dike. Silt shall be removed in a timely manner. If erosion is occurring on the face of the dike, the slopes of the face shall either be stabilized through mulch or seeding, or the slopes of the face shall be reduced.

Diversion Channel (Swale)

Inspection must be made weekly and after each significant (>0.5 inch) rainfall to locate and repair any damage to the channel or to clear debris or other obstructions so as not to diminish flow capacity. Damage from storms or normal construction activities, such as tire ruts or disturbance of swale stabilization, shall be repaired as soon as practical.

NOTES

- Berms shall have a minimum height of 18 inches, side slopes of 2:1 or flatter, and a minimum base width of 2 feet.
- The minimum freeboard shall be 6 inches.
- Berms and diversions should be constructed of compacted soil or coarse aggregate.
- All berms shall have an uninterrupted positive grade to a stabilized outlet.
- Diversion channels shall be excavated or shaped to line, grade, and cross section as indicated in the plans and as required to meet the criteria specified.
- Berms and diversion channels should be stabilized within 14 days of their construction.
- Periodically, and after each rain event, berms and dikes should be inspected, and accumulated sediments against berms should be removed.

Diversion Channel Dike and Swale (continued)

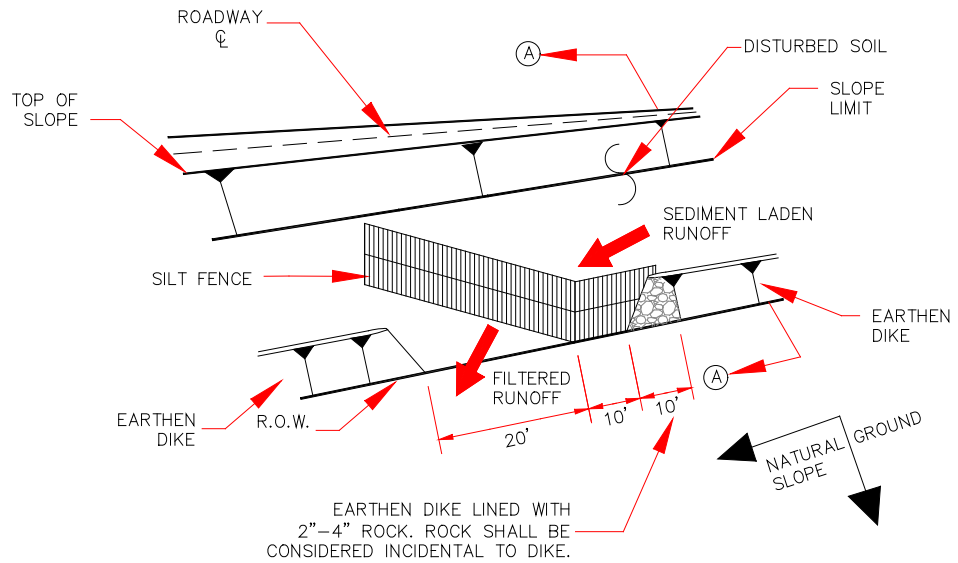

PLAN

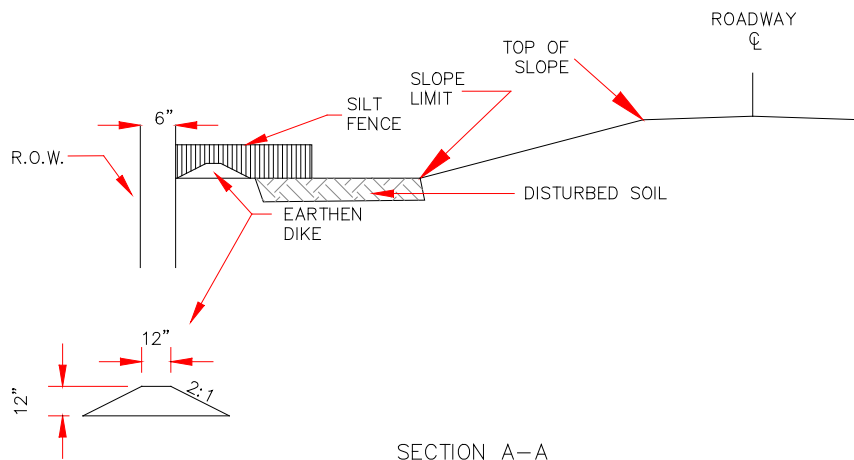

(This page intentionally blank)

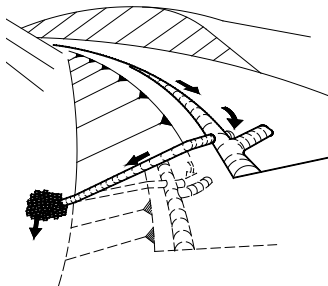
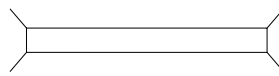
| <p>Slope Drain</p>  | <p>Applications</p> <ul style="list-style-type: none"> Perimeter Control ✓ Slope Protection Sediment Trapping Channel Protection Temporary Stabilization Permanent Stabilization Waste Management Housekeeping Practices | | | | | | | | | | |
|---|---|---------------------------------|---------|----|-----------|----|------------|----|-------------|----|--|
| <p>DESCRIPTION</p> <p>A slope drain is a temporary pipeline that conveys flow down an unstabilized slope. The drain is anchored on the upstream end with some form of headwall to limit erosion and secure the pipe.</p> <p>PRIMARY USE</p> <p>Slope drains are used on long, unstablized, steep slopes subject to erosion from overland flow. Flow from the drain should be routed to a sediment-reduction treatment.</p> <p>APPLICATIONS</p> <p>Slope drains are useful on sites with large berms or grade changes. Since flow must be directed into the drain, some upstream grading is usually required, as is some form of velocity reduction treatment at the downstream end to reduce velocity and spread the flow.</p> <p>The allowable runoff flow rates to a temporary slope drain are as follows:</p> | <p>Targeted Constituents</p> <ul style="list-style-type: none"> ✓ Sediment Nutrients Toxic Materials Oil and Grease ✓ Floatable Materials Construction Wastes | | | | | | | | | | |
| <table border="1" data-bbox="316 1375 1047 1585"> <thead> <tr> <th>Runoff Flow Rate (cfs)</th> <th>Pipe Diameter Required (inches)</th> </tr> </thead> <tbody> <tr> <td>0 – 6.0</td> <td>18</td> </tr> <tr> <td>6.0 – 9.0</td> <td>21</td> </tr> <tr> <td>9.0 – 12.0</td> <td>24</td> </tr> <tr> <td>12.0 – 20.0</td> <td>30</td> </tr> </tbody> </table> | Runoff Flow Rate (cfs) | Pipe Diameter Required (inches) | 0 – 6.0 | 18 | 6.0 – 9.0 | 21 | 9.0 – 12.0 | 24 | 12.0 – 20.0 | 30 | <p>Impact</p> <ul style="list-style-type: none"> ✓ Significant ✓ Medium Low Unknown or Questionable |
| Runoff Flow Rate (cfs) | Pipe Diameter Required (inches) | | | | | | | | | | |
| 0 – 6.0 | 18 | | | | | | | | | | |
| 6.0 – 9.0 | 21 | | | | | | | | | | |
| 9.0 – 12.0 | 24 | | | | | | | | | | |
| 12.0 – 20.0 | 30 | | | | | | | | | | |
| <p>LIMITATIONS</p> <p>Drains must be located away from construction areas, since the drain can easily be damaged by construction traffic.</p> <p>Securing the pipe to the slope can be difficult and require significant maintenance during the life of the system.</p> |  | | | | | | | | | | |

Slope Drain (continued)

In situations where pipe slope drains convey sediment-laden runoff, pipes can become clogged during large rain events, causing water to overtop the diversion dike and thereby creating a serious erosion condition.

Grading is normally required upstream of the pipe slope drain in order to direct flow into the system. This can cause additional cost and maintenance.

A pipe slope drain reduces erosion but does not prevent it or reduce the amount of sediment in the runoff. Additional measures should be used in conjunction with the pipe slope drain to treat the flow.

MAINTENANCE REQUIREMENTS

Inspection must be made of the pipe after each significant (>0.5 inch) rainfall to locate and repair any damage to joints or clogging of the pipe. In cases where the diversion dike has deteriorated from around the entrance of the pipe, it may be necessary to reinforce the dike with sandbags or to install a concrete collar to prevent failure. Signs of erosion around the pipe drain should be addressed in a timely manner by stabilizing the area with erosion control mats, crushed stone, concrete, or other acceptable method.

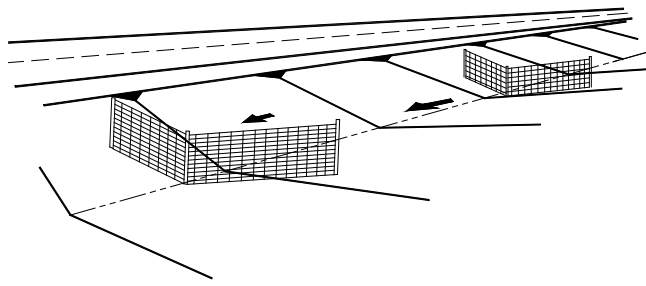
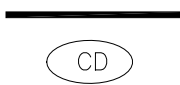
| <p>Check Dam</p>  | <p>Applications</p> <ul style="list-style-type: none"> Perimeter Control Slope Protection ✓ Sediment Trapping ✓ Channel Protection Temporary Stabilization Permanent Stabilization Waste Management Housekeeping Practices | | | | | | |
|---|---|------------------------|-------|-----|---------|-----|---|
| <p>DESCRIPTION</p> <p>Check dams are small temporary dams constructed across a swale or drainage ditch.</p> <p>PRIMARY USE</p> <p>Check dams are used to reduce the velocity of concentrated storm water flows, thus reducing erosion in the swale or ditch; to slow the flow velocity to allow sediment capture.</p> <p>APPLICATIONS</p> <p>Check dams are used to slow velocity in smaller channels and temporary swales (i.e., open channels that drain ten acres or less).</p> <p>The maximum allowable runoff flow rate to an individual check dam is as follows:</p> <table border="1" data-bbox="316 1270 1023 1402"> <thead> <tr> <th>Longitudinal Slope (%)</th> <th>Runoff Flow Rate (cfs)</th> </tr> </thead> <tbody> <tr> <td>0 – 2</td> <td>1.0</td> </tr> <tr> <td>2.1 - 4</td> <td>0.5</td> </tr> </tbody> </table> | Longitudinal Slope (%) | Runoff Flow Rate (cfs) | 0 – 2 | 1.0 | 2.1 - 4 | 0.5 | <p>Targeted Constituents</p> <ul style="list-style-type: none"> ✓ Sediment Nutrients Toxic Materials Oil and Grease Floatable Materials Construction Wastes <p>Impact</p> <ul style="list-style-type: none"> ✓ Significant ✓ Medium Low Unknown or Questionable |
| Longitudinal Slope (%) | Runoff Flow Rate (cfs) | | | | | | |
| 0 – 2 | 1.0 | | | | | | |
| 2.1 - 4 | 0.5 | | | | | | |
| <p>LIMITATIONS</p> <p>Minor ponding will occur upstream of the check dams.</p> <p>For heavy flows or high-velocity flows, extensive maintenance or replacement of the dams will be required.</p> <p>Check dams are not a total treatment technique.</p> <p>MAINTENANCE REQUIREMENTS</p> <p>Maintenance of the dams should adhere to the maintenance requirements of the management practice used for the dam.</p> |  | | | | | | |

Check Dam (continued)

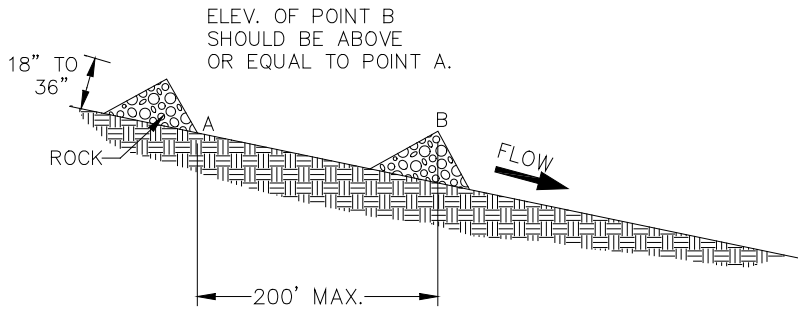

CHECK DAMS

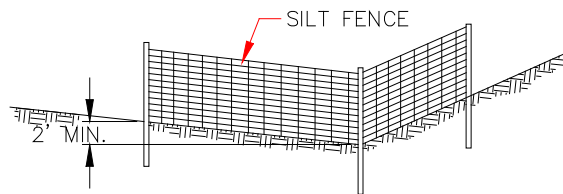

TYPE I
SILT FENCE

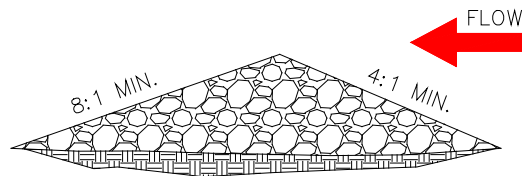
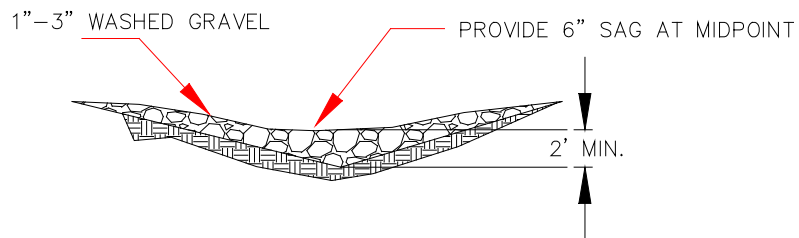

TYPE II
STONE DAM

Check Dam (continued)



Check dams at roadside ditch



Check dam at roadside ditch



Check dams at median

(This page intentionally blank)

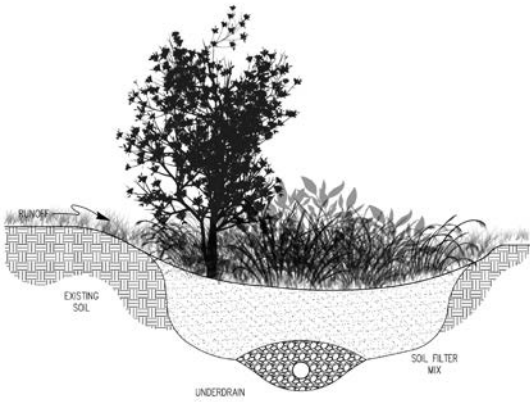
| | |
|--|---|
| <h2 style="text-align: center;">BioRetention</h2>  | <p style="text-align: center;">Applications</p> <ul style="list-style-type: none"> ✓ Perimeter Control <li style="padding-left: 20px;">Slope Protection ✓ Sediment Trapping ✓ Channel Protection <li style="padding-left: 20px;">Temporary Stabilization ✓ Permanent Stabilization <li style="padding-left: 20px;">Waste Management <li style="padding-left: 20px;">Housekeeping Practices |
| <p>DESCRIPTION</p> <p>A soil and vegetation filtration device utilizing natural media for pollutant removal through a variety of physical, biological, and chemical treatments. Can provide reduction in velocity, filtration and extended detention. Typical application includes a buffer strip and a depressed ponding area. Absorption of ponded water into the Bioretention area is dependant on porosity of subsurface soils and media.</p> | <p style="text-align: center;">Targeted Constituents</p> <ul style="list-style-type: none"> ✓ Sediment ✓ Nutrients <li style="padding-left: 20px;">Toxic Materials ✓ Oil and Grease ✓ Floatable Materials <li style="padding-left: 20px;">Construction Wastes |
| <p>PRIMARY USE</p> <p>Removal of stormwater pollutants through adsorption, filtration, plant uptake, sedimentation, and microbial activity. Common particulates removed include organics, nutrients, and suspended solids. Sedimentation can occur at the surface of a depressed Bioretention area as velocities are reduced and solids fall out of suspension.</p> | <p style="text-align: center;">Impact</p> <ul style="list-style-type: none"> ✓ Significant ✓ Medium <li style="padding-left: 20px;">Low <li style="padding-left: 20px;">Unknown or Questionable |
| <p>APPLICATIONS</p> <p>Bioretention is appropriate for urban developed conditions. Perimeter landscaping in developments affords an excellent opportunity for Bioretention. Underdrains may be required with low soil permeability of existing soils.</p> <p>LIMITATIONS</p> <p>Not suitable for steep slopes or high velocity flows.</p> <p>Not suitable at locations with water table within 6 feet of ground surface.</p> <p>May provide mosquito breeding habitat.</p> <p>MAINTENANCE REQUIREMENTS</p> <p>Inspections should be made on an annual basis. Removal and replacement of dead vegetation, pruning and weeding, and removal of deposited sediment may be necessary.</p> | <div style="border: 1px solid black; width: 100px; height: 100px; display: flex; align-items: center; justify-content: center; margin: 20px auto;"> BR </div> |

(This page intentionally blank)

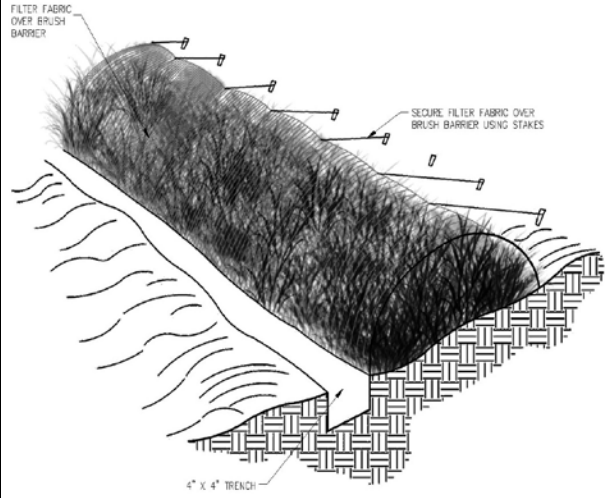
| | |
|---|---|
| <p>Brush Barrier</p>  | <p>Applications</p> <ul style="list-style-type: none"> ✓ Perimeter Control ✓ Slope Protection ✓ Sediment Trapping Channel Protection ✓ Temporary Stabilization Permanent Stabilization Waste Management Housekeeping Practices |
| <p>DESCRIPTION</p> <p>A perimeter sediment control structure utilizing cleared and grubbed materials from the job site. A brush barrier can be constructed of small tree branches, vegetative matter, root systems, cobble, and other organic material from the clearing operation. The barrier can be covered with filter cloth or tied with stakes and twine to stabilize the structure and provide improved performance.</p> | <p>Targeted Constituents</p> <ul style="list-style-type: none"> ✓ Sediment ✓ Nutrients Toxic Materials ✓ Oil and Grease Floatable Materials Construction Wastes |
| <p>PRIMARY USE</p> <p>Perimeter control to promote sediment deposition and filtration. Provides a low impact use of clear and grubbed organic materials onsite.</p> | <p>Impact</p> <ul style="list-style-type: none"> Significant ✓ Medium Low Unknown or Questionable |
| <p>APPLICATIONS</p> <p>Suitable for sheet flow situations where approaching slopes are less than 3:1. Drainage area flowing into a brush barrier should not exceed ¼ acre per 100 linear feet of brush barrier.</p> <p>LIMITATIONS</p> <p>Not appropriate in steep areas, high velocities, or concentrated flows.</p> <p>Temporary BMP as the organic material comprising barrier will decompose over time.</p> <p>Brush Barriers without filter fabric covering may erode if barrier material is light and fine.</p> <p>MAINTENANCE REQUIREMENTS</p> <p>Inspections should be made on a weekly basis, especially after large storm events. If the filter becomes eroded, maintenance may be required to reconstruct berm.</p> | <p style="text-align: center;">BB</p> |

(This page intentionally blank)

| | |
|--|--|
| <h2 style="text-align: center;">Detention Basin</h2> | <h3 style="text-align: center;">Applications</h3> <ul style="list-style-type: none"> Perimeter Control Slope Protection ✓ Sediment Trapping Channel Protection ✓ Temporary Stabilization ✓ Permanent Stabilization Waste Management ✓ Housekeeping Practices |
| <h3>DESCRIPTION</h3> <p>A constructed basin with a restrictive outlet sized to slowly release collected storm water runoff. Detention basins improve stormwater runoff quality by holding sediment laden runoff in a quiescent zone, allowing sediment and associated pollutants to settle out prior to effluent discharge.</p> | <h3 style="text-align: center;">Targeted Constituents</h3> <ul style="list-style-type: none"> ✓ Sediment Nutrients Toxic Materials ✓ Oil and Grease ✓ Floatable Materials Construction Wastes |
| <h3>PRIMARY USE</h3> <p>Detention basins can provide: reduction of flowrates, reduced velocities, and provision of a sedimentation area. Provides Stormwater collection area for larger projects and mitigates release rates.</p> | <h3 style="text-align: center;">Impact</h3> <ul style="list-style-type: none"> ✓ Significant ✓ Medium Low Unknown or Questionable |
| <h3>APPLICATIONS</h3> <p>Suitable for larger projects where drainage can be channelized or otherwise conveyed into basin. Can be utilized as a construction phase BMP and then modified to a permanent post-construction BMP.</p> <h3>LIMITATIONS</h3> <p>Not effective at removing liquid and dissolved pollutants. Requires appropriate topography for drainage consideration. Must be designed with downstream and failure considerations taken into account. May become a site safety and public welfare concern.</p> <h3>MAINTENANCE REQUIREMENTS</h3> <p>Inspections should be made on a bi-weekly basis, prior to storm events, and after storm events. To minimize vector viability, regular removal of vegetation should be part of maintenance program.</p> | <div style="border: 1px solid black; padding: 20px; font-size: 48px; font-weight: bold; width: 100px; margin: 0 auto;">DB</div> |

(This page intentionally blank)

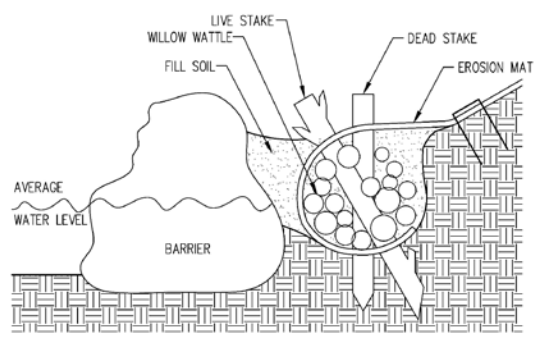
| | |
|---|---|
| <p>Fiberschines/Biologs</p> | <p>Applications</p> <ul style="list-style-type: none"> ✓ Perimeter Control ✓ Slope Protection ✓ Sediment Trapping ✓ Channel Protection ✓ Temporary Stabilization Permanent Stabilization Waste Management Housekeeping Practices |
|  | <p>Targeted Constituents</p> <ul style="list-style-type: none"> ✓ Sediment ✓ Nutrients Toxic Materials ✓ Oil and Grease Floatable Materials Construction Wastes |
| <p>DESCRIPTION</p> <p>Vegetated rolls typically utilizing coconut-fiber used to stabilize slopes. Plant cuttings or seeding are applied into the fiberschine or under the roll. As the fiberschine decomposes, plantings and seeds are rooted, providing permanent stabilization.</p> <p>PRIMARY USE</p> <p>Primarily used for streambank slope stabilization. May be suitable for perimeter control and final stabilization enhancement. Provides enhanced organic environment for planting and seeding germination.</p> | <p>Impact</p> <p>Significant</p> <p>Medium</p> <ul style="list-style-type: none"> ✓ Low Unknown or Questionable |
| <p>APPLICATIONS</p> <p>May be suitable as temporary perimeter control BMP. Provides lighter weight linear BMP.</p> | <p style="text-align: center;">— FS —</p> |
| <p>LIMITATIONS</p> <p>Fairly expensive for a temporary construction phase BMP.</p> <p>MAINTENANCE REQUIREMENTS</p> <p>Inspections should be made on a monthly basis, especially after large storm events. Watering may be required if seeding or plantings are applied.</p> | |

(This page intentionally blank)

| <h2 style="text-align: center;">Wood Chip Berm</h2> | <h3 style="text-align: center;">Applications</h3> |
|--|--|
| | <ul style="list-style-type: none"> ✓ Perimeter Control ✓ Slope Protection ✓ Sediment Trapping Channel Protection ✓ Temporary Stabilization Permanent Stabilization Waste Management Housekeeping Practices |
| <p>DESCRIPTION</p> <p>Raised berm utilizing wood chips or composted solids. Linear berm is comprised of wood chips, recycled vegetative matter, or compost. Provides a sediment trapping mechanism for low-sloped sheet flow conditions.</p> <p>PRIMARY USE</p> <p>Appropriate for perimeter BMP in light sheet flow conditions. Wood chip berms reduce sediment from runoff by slowing and filtering runoff and dissipating flows. A Compost Filter Berm is a sediment filter consisting of composted material blown into a berm configuration below a disturbed area for the purpose of filtering the sediment-laden runoff before exiting the site.</p> <p>APPLICATIONS</p> <p>Wood Chip Berms may be vegetated or unvegetated and may be left in place to provide long-term filtration of stormwater as a post-construction BMP. Should be placed on existing level grades, and ends or berms should be warped to provide sheet flow containment.</p> <p>LIMITATIONS</p> <p>Maximum slope upstream should not exceed 3%. Repetitive storm occurrences may inundate and render wood chip berm ineffective. Any section which has been undermined or overtopped may require immediate reconstruction.</p> <p>MAINTENANCE REQUIREMENTS</p> <p>Inspections should be made on a bi-weekly basis, especially after large storm events. Immediate repair is required to maintain efficiency.</p> | <p style="text-align: center;">Targeted Constituents</p> <ul style="list-style-type: none"> ✓ Sediment ✓ Nutrients Toxic Materials ✓ Oil and Grease Floatable Materials Construction Wastes |
| | <p style="text-align: center;">Impact</p> <p style="text-align: center;">Significant</p> <ul style="list-style-type: none"> ✓ Medium ✓ Low <p style="text-align: center;">Unknown or Questionable</p> |
| | |

(This page intentionally blank)

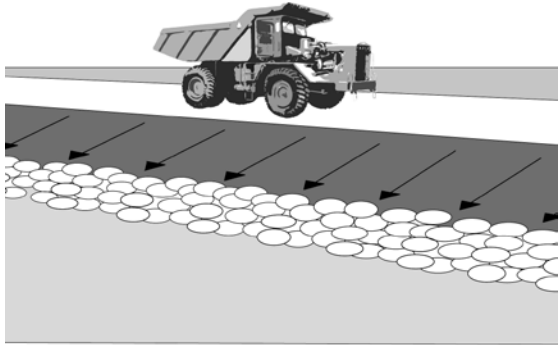
| | |
|--|---|
| <p>Toe Rock</p>  | <p>Applications</p> <ul style="list-style-type: none"> ✓ Perimeter Control ✓ Slope Protection ✓ Sediment Trapping Channel Protection ✓ Temporary Stabilization ✓ Permanent Stabilization Waste Management Housekeeping Practices |
| <p>DESCRIPTION</p> <p>Rock toe of slope protection is a rock or rip rap matrix placed against a failed portion of slope or at toe of slope to provide a buttress against additional failure and to provide a check structure at the toe of steep slopes. The weight and interlocking characteristics of large rip rap provides a stabilizing force.</p> <p>PRIMARY USE</p> <p>Steep slope stabilization and screening of flows at the toe of slopes.</p> | <p>Targeted Constituents</p> <ul style="list-style-type: none"> ✓ Sediment Nutrients Toxic Materials Oil and Grease ✓ Floatable Materials Construction Wastes |
| <p>APPLICATIONS</p> <p>Typically utilized at toe of slopes draining to small streams or rovers, may also be utilized for slope and toe of slope protection. May be employed to stabilize small slides, or to protect grade transitions adjacent to small structures against erosion. Can be utilized as temporary BMP during construction phase.</p> | <p>Impact</p> <ul style="list-style-type: none"> Significant ✓ Medium ✓ Low Unknown or Questionable |
| <p>LIMITATIONS</p> <p>Toe rock protection does not provide protection against erosion due to overland flow</p> <p>Fairly expensive for a temporary construction phase BMP.</p> <p>Higher solids loading will cover BMP.</p> <p>MAINTENANCE REQUIREMENTS</p> <p>Inspections should be made on a monthly basis, especially after large storm events. If the rock becomes inundated with sediment, screening and reconstruction may be required.</p> | <p style="text-align: center;">— TR —</p> |

(This page intentionally blank)

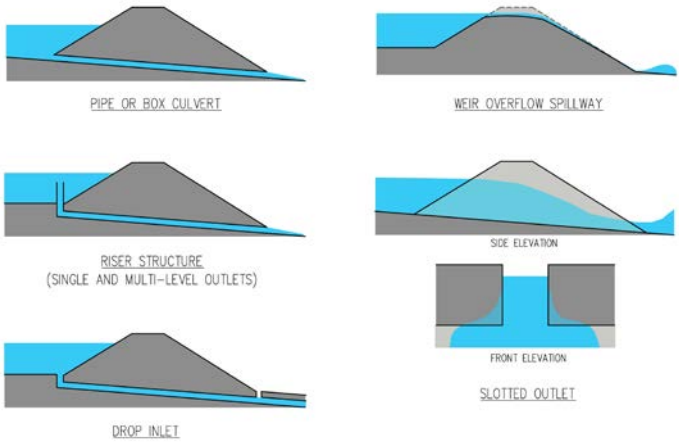
| <h2 style="text-align: center;">Outlet Structure</h2> | <h3 style="text-align: center;">Applications</h3> |
|---|--|
|  <p style="text-align: center;">PIPE OR BOX CULVERT</p> <p style="text-align: center;">WEIR OVERFLOW SPILLWAY</p> <p style="text-align: center;">RISER STRUCTURE (SINGLE AND MULTI-LEVEL OUTLETS)</p> <p style="text-align: center;">DROP INLET</p> <p style="text-align: center;">SIDE ELEVATION</p> <p style="text-align: center;">FRONT ELEVATION SLOTTED OUTLET</p> | <ul style="list-style-type: none"> Perimeter Control Slope Protection ✓ Sediment Trapping ✓ Channel Protection ✓ Temporary Stabilization ✓ Permanent Stabilization Waste Management Housekeeping Practices |
| <p>DESCRIPTION</p> <p>A flow restrictive device placed at the discharge point of a storm water detention basin or check structure. Outlet structures can provide mitigation for flowrates, velocities, floatables, and can provide sedimentation. Outlet Structures include a wide range of designs, including orifice plates, baffle-boxes, mechanical screens, ported risers, trash racks, and weir configurations.</p> | <h3 style="text-align: center;">Targeted Constituents</h3> <ul style="list-style-type: none"> ✓ Sediment ✓ Nutrients Toxic Materials Oil and Grease ✓ Floatable Materials Construction Wastes |
| <p>PRIMARY USE</p> <p>Primarily utilized to be utilized in conjunction with detention basins. May be utilized as temporary BMP for construction phase activities. Out Structures provide mechanism for metering flowrates and reducing velocities to allow particles and associated pollutants to settle.</p> | <h3 style="text-align: center;">Impact</h3> <ul style="list-style-type: none"> ✓ Significant ✓ Medium Low Unknown or Questionable |
| <p>APPLICATIONS</p> <p>If constructed with initial grading operations, an outlet structure can provide a site-wide BMP for sediment control. In post-construction applications, Outlet Structures can provide mitigation of a wide range of pollutants. Outlet Structures are also utilized for site storm water flowrate mitigation, and are typically designed to provide both storm water quality as well as flowrate mitigation.</p> <p>LIMITATIONS</p> <p>Construction phase Outlet Structure may require regular maintenance to remove accumulated sediment.</p> <p>Outlet Structure requires an impoundment mechanism to convey flows into structure.</p> <p>MAINTENANCE REQUIREMENTS</p> <p>Inspections should be made on a monthly basis, especially after large storm events. If the Outlet Structure becomes inundated, debris and sediment removal are immediately required.</p> | <div style="border: 1px solid black; width: 100px; height: 100px; margin: 0 auto; display: flex; align-items: center; justify-content: center;"> OS </div> |

(This page intentionally blank)

| <h2 style="text-align: center;">Guardrail End Treatment</h2> | <h3 style="text-align: center;">Applications</h3> |
|--|---|
| | <ul style="list-style-type: none"> Perimeter Control ✓ Slope Protection ✓ Sediment Trapping Channel Protection ✓ Temporary Stabilization ✓ Permanent Stabilization Waste Management Housekeeping Practices <h3 style="text-align: center;">Targeted Constituents</h3> <ul style="list-style-type: none"> ✓ Sediment ✓ Nutrients Toxic Materials ✓ Oil and Grease Floatable Materials Construction Wastes |
| <p>DESCRIPTION</p> <p>Guardrail end sections may lie on road embankments where slopes convey roadway sheet flows and roadway embankment may not be appropriately compacted and revegetated due to guardrail post construction. Guardrail end treatment extends hardened surface through post area and provides toe-of-slope protection.</p> <p>PRIMARY USE</p> <p>Mitigation of erosion near guardrail end treatments and storm water quality treatment at these locations. Local roadway drainage is often designed to exit roadway near end of guardrail to flow to culverts.</p> <p>APPLICATIONS</p> <p>Guardrail End treatment is applicable to new projects as a project design, or to existing guardrail end sections where roadway sheet flows may have eroded road embankment adjacent to guardrail ends.</p> <p>LIMITATIONS</p> <p>May only be suitable if roadway sheet flows exit roadway at this location.</p> <p>As permanent BMP, wattle maintenance and replacement may be required.</p> <p>MAINTENANCE REQUIREMENTS</p> <p>Inspections should be made on a monthly basis, especially after large storm events. If the wattle becomes damaged by flows, it will need to be replaced.</p> | <h3 style="text-align: center;">Impact</h3> <ul style="list-style-type: none"> Significant ✓ Medium Low Unknown or Questionable <div style="text-align: center;"> </div> |

(This page intentionally blank)

Appendix A4

Sediment Control

- Buffer Strip
- Silt Fence
- Straw Bale
- Drop Inlet Protection
- Culvert Protection
- Sediment Trap – Berm/Excavated
- Sediment Basin
- Triangular Sediment Filter Dike
- Compost Filter Berm
- Straw Wattle
- Filter Strips
- Media Filter
- Mechanical Devices
- Live Wattles

(This page intentionally blank)

Sediment Control







(This page intentionally blank)

Sediment Control

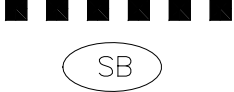
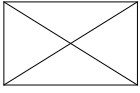
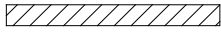
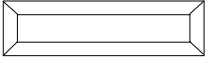
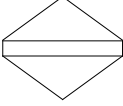
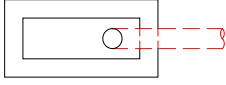
TABLE OF CONTENTS

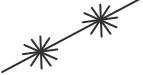
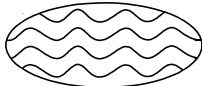

| BMP | Page |
|---------------------------------------|-------------|
| Symbols | A4-2 |
| Buffer Strip | A4-3 |
| Silt Fence | A4-5 |
| Straw Bale | A4-9 |
| Drop Inlet Protection..... | A4-13 |
| Culvert Protection..... | A4-17 |
| Sediment Trap – Berm/Excavated | A4-19 |
| Sediment Basin | A4-23 |
| Triangular Sediment Filter Dike | A4-27 |
| Compost Filter Berm..... | A4-29 |
| Straw Wattle | A4-31 |
| Filter Strips | A4-33 |
| Media Filter | A4-35 |
| Mechanical Devices..... | A4-37 |
| Live Wattles..... | A4-39 |

SYMBOLS

| | |
|--|---|
| <p>Silt Fence</p>  | <p>Straw Bale</p>  |
| <p>Drop Inlet Protection</p>  | <p>Culvert Protection</p>  |
| <p>Sediment Trap, Excavated</p>  | <p>Sediment Trap, Berm</p>  |
| <p>Sediment Basin</p>  | <p>Triangular Sediment Filter Dike</p>  |
| <p>Compost Filter Berm</p>  | <p>Straw Wattle</p>  |
| <p>Filter Strips</p>  | <p>Media Filter</p>  |
| <p>Mechanical Devices</p>  | <p>Live Wattles</p>  |

| Buffer Strip | | | | | Applications | | | | | | | | | | | | | | | | | | | | | | | | | | | | | | | | | | | | | | | | | | | | |
|---|-----------------------|-----------------------|-----------------------|-----------------------|--|------------|--|--------------|--|-----------------------|-----------------------|-----------------------|-----------------------|-----|-----|----|-----|-----|---|-----|-----|-----|-----|---|-----|-----|-----|-----|---|-----|-----|---|-----|---|---|-----|---|-----|---|---|-----|---|-----|----|---|-----|---|---|--|
| <p>DESCRIPTION</p> <p>A buffer strip is intended for use where sheet flow from a disturbed area discharges onto an undisturbed slope where the sheet flow regime will be maintained. A buffer strip does not require supplemental measures if installed following these guidelines.</p> <p>APPLICATIONS</p> <p>The maximum allowable disturbance width is 30 feet (width measured parallel to flow path). An overland flow buffer width on an undisturbed slope sufficient to provide a minimum 20-minute sheet-flow travel time is required to attain adequate sediment removal. Therefore, this measure should only be used at locations where sheet flow over the required width can reasonably be ensured. The maximum buffer strip width is generally limited to 400 feet. Since the widths required will generally fall outside of the right-of-way, possible conflicts with private land use should be considered.</p> <p>The required buffer strip width is as follows. These widths are measured from the edge of the disturbed area.</p> <p style="text-align: center;">2-YEAR, 24-HOUR PRECIPITATION</p> <table border="1" style="margin-left: auto; margin-right: auto;"> <thead> <tr> <th rowspan="2">Buffer Strip Slope (%)</th> <th colspan="2">0-1.8 inch</th> <th colspan="2">1.9-2.7 inch</th> </tr> <tr> <th>Poor Cover Width (ft)</th> <th>Fair Cover Width (ft)</th> <th>Poor Cover Width (ft)</th> <th>Fair Cover Width (ft)</th> </tr> </thead> <tbody> <tr> <td>0.5</td> <td>167</td> <td>78</td> <td>216</td> <td>101</td> </tr> <tr> <td>1</td> <td>237</td> <td>110</td> <td>305</td> <td>142</td> </tr> <tr> <td>2</td> <td>335</td> <td>156</td> <td>431</td> <td>201</td> </tr> <tr> <td>4</td> <td>473</td> <td>221</td> <td>—</td> <td>285</td> </tr> <tr> <td>6</td> <td>—</td> <td>271</td> <td>—</td> <td>349</td> </tr> <tr> <td>8</td> <td>—</td> <td>312</td> <td>—</td> <td>403</td> </tr> <tr> <td>10</td> <td>—</td> <td>349</td> <td>—</td> <td>—</td> </tr> </tbody> </table> | | | | | Buffer Strip Slope (%) | 0-1.8 inch | | 1.9-2.7 inch | | Poor Cover Width (ft) | Fair Cover Width (ft) | Poor Cover Width (ft) | Fair Cover Width (ft) | 0.5 | 167 | 78 | 216 | 101 | 1 | 237 | 110 | 305 | 142 | 2 | 335 | 156 | 431 | 201 | 4 | 473 | 221 | — | 285 | 6 | — | 271 | — | 349 | 8 | — | 312 | — | 403 | 10 | — | 349 | — | — | <ul style="list-style-type: none"> ✓ Perimeter Control ✓ Slope Protection ✓ Sediment Trapping Channel Protection Temporary Stabilization Permanent Stabilization Waste Management Housekeeping Practices |
| Buffer Strip Slope (%) | 0-1.8 inch | | 1.9-2.7 inch | | | | | | | | | | | | | | | | | | | | | | | | | | | | | | | | | | | | | | | | | | | | | | |
| | Poor Cover Width (ft) | Fair Cover Width (ft) | Poor Cover Width (ft) | Fair Cover Width (ft) | | | | | | | | | | | | | | | | | | | | | | | | | | | | | | | | | | | | | | | | | | | | | |
| 0.5 | 167 | 78 | 216 | 101 | | | | | | | | | | | | | | | | | | | | | | | | | | | | | | | | | | | | | | | | | | | | | |
| 1 | 237 | 110 | 305 | 142 | | | | | | | | | | | | | | | | | | | | | | | | | | | | | | | | | | | | | | | | | | | | | |
| 2 | 335 | 156 | 431 | 201 | | | | | | | | | | | | | | | | | | | | | | | | | | | | | | | | | | | | | | | | | | | | | |
| 4 | 473 | 221 | — | 285 | | | | | | | | | | | | | | | | | | | | | | | | | | | | | | | | | | | | | | | | | | | | | |
| 6 | — | 271 | — | 349 | | | | | | | | | | | | | | | | | | | | | | | | | | | | | | | | | | | | | | | | | | | | | |
| 8 | — | 312 | — | 403 | | | | | | | | | | | | | | | | | | | | | | | | | | | | | | | | | | | | | | | | | | | | | |
| 10 | — | 349 | — | — | | | | | | | | | | | | | | | | | | | | | | | | | | | | | | | | | | | | | | | | | | | | | |
| <p style="text-align: center;">Targeted Constituents</p> <ul style="list-style-type: none"> ✓ Sediment Nutrients Toxic Materials Oil and Grease Floatable Materials Construction Wastes | | | | | <p style="text-align: center;">Impact</p> <ul style="list-style-type: none"> ✓ Significant Medium Low Unknown or Questionable | | | | | | | | | | | | | | | | | | | | | | | | | | | | | | | | | | | | | | | | | | | | |

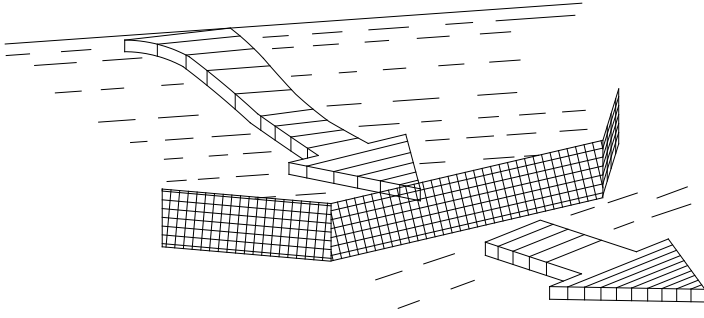
(This page intentionally blank)

| | |
|---|---|
| <p>Silt Fence</p>  | <p>Applications</p> <ul style="list-style-type: none"> ✓ Perimeter Control ✓ Slope Protection ✓ Sediment Trapping Channel Protection Temporary Stabilization Permanent Stabilization Waste Management Housekeeping Practices |
| <p>DESCRIPTION</p> <p>A silt fence consists of geotextile fabric supported by backing stretched between posts, with the lower edge securely embedded in soil downstream of disturbed areas. Intercepts runoff in the form of sheet flow and provides filtration, sedimentation, and velocity reduction.</p> <p>PRIMARY USE</p> <p>Silt fences are used as perimeter control downstream of disturbed areas, and for non-concentrated sheet-flow conditions.</p> <p>APPLICATIONS</p> <p>Silt fences provide an economical way to mitigate overflow, non-concentrated flows, and as a perimeter control device. Best with coarse to silty soil types and to control wind erosion on sandy soils.</p> <p>LIMITATIONS</p> <p>Minor ponding will likely occur at the upstream side of the silt fence, resulting in minor localized flooding.</p> <p>Fences that are constructed in swales or low areas subject to concentrated flow may be overtopped, resulting in failure of the filter fence. Silt fences subject to areas of concentrated flow (waterways with flows >1 cfs) are not acceptable.</p> <p>Silt fence can interfere with construction operations; therefore, planning of access routes onto the site is critical.</p> <p>Silt fence can fail structurally under heavy storm flows, creating maintenance problems and reducing the effectiveness of the system.</p> <p>MAINTENANCE REQUIREMENTS</p> <p>Inspections should be made on a weekly basis, especially after large storm events. If the fabric becomes clogged, it should be cleaned or, if necessary, replaced.</p> <p>Sediment should be removed when it reaches approximately one-half the height of the fence.</p> | <p>Targeted Constituents</p> <ul style="list-style-type: none"> ✓ Sediment Nutrients Toxic Materials Oil and Grease ✓ Floatable Materials Construction Wastes <p>Impact</p> <ul style="list-style-type: none"> ✓ Significant ✓ Medium Low Unknown or Questionable |
| |  |

Silt Fence (continued)

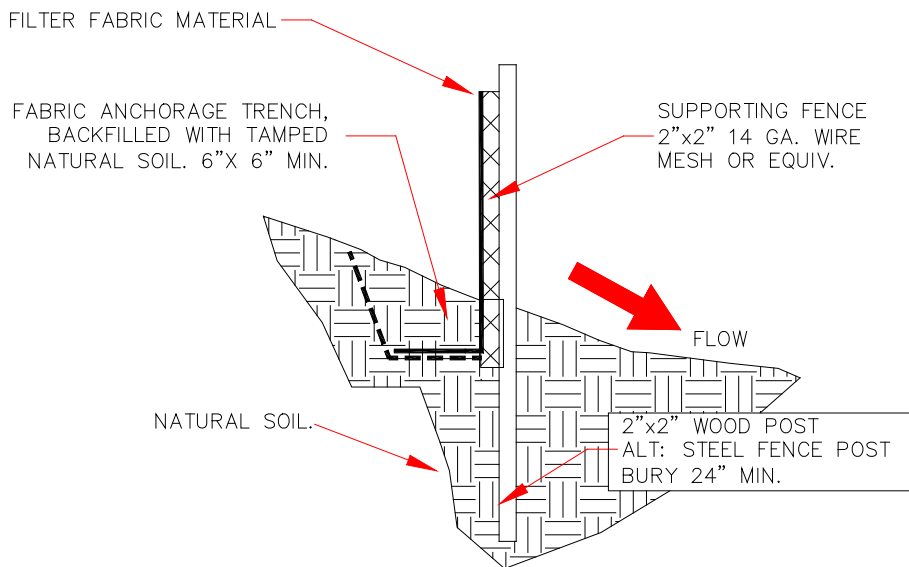
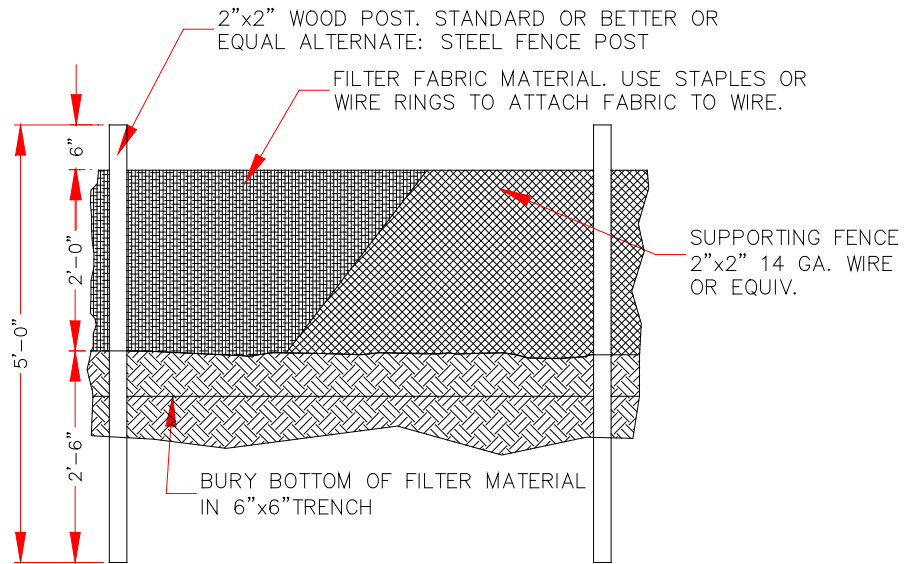

Silt Fence (continued)



Silt fence in urban area



Silt fence in urban area



Silt fence in rural area



Silt fence at outlet of box

(This page intentionally blank)

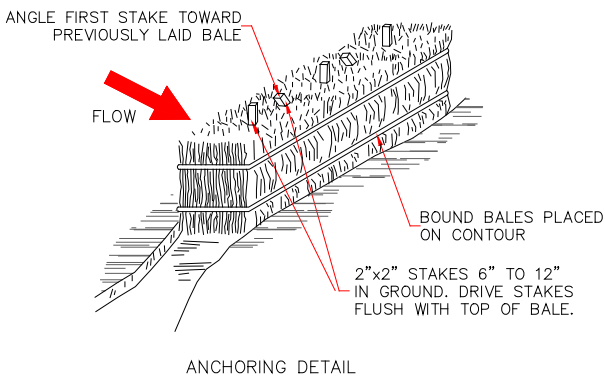
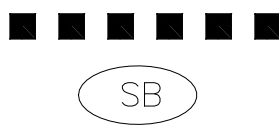
| | |
|---|--|
| <h2 style="text-align: center;">Straw Bale</h2>  <p style="text-align: center;">ANCHORING DETAIL</p> | <h3 style="text-align: center;">Applications</h3> <ul style="list-style-type: none"> ✓ Perimeter Control Slope Protection ✓ Sediment Trapping Channel Protection Temporary Stabilization Permanent Stabilization Waste Management Housekeeping Practices |
| <h3>DESCRIPTION</h3> <p>A temporary barrier can be constructed of straw bales anchored with posts or stakes, which intercepts sediment-laden runoff from small, disturbed areas. Straw-bales barriers can provide filtration or serve as a dam/device to direct flow.</p> <h3>PRIMARY USE</h3> <p>Straw bales barriers trap sediment-laden runoff from small, relatively level areas; velocity reduction causes sediment to settle out.</p> | <h3 style="text-align: center;">Targeted Constituents</h3> <ul style="list-style-type: none"> ✓ Sediment Nutrients Toxic Materials Oil and Grease ✓ Floatable Materials Construction Wastes |
| <h3>APPLICATIONS</h3> <p>Straw bales barriers treat flow from small sites for short-duration projects. Can be used as check dams on small watercourses. Problems with uniformity, degradation and installation; residential applications suggested.</p> <p><i>Sheet-Flow Applications</i></p> <ul style="list-style-type: none"> • Place the bales in a single row, lengthwise on the contour, with ends of adjacent bales tightly abutting. | <h3 style="text-align: center;">Impact</h3> <ul style="list-style-type: none"> ✓ Significant ✓ Medium Low Unknown or Questionable |
| <h3>LIMITATIONS</h3> <p>Due to a short effective life caused by biological decomposition, straw bales must be replaced after a period of no more than 3 months. During the wet and warm seasons, however, they must be replaced more frequently as is determined by periodic inspections for structural integrity.</p> <p>Straw bale dikes are not recommended for use with concentrated flows.</p> <p>The effectiveness of straw bales in reducing sediment is very limited. Improperly maintained, straw bales can have a negative impact on the water quality of the runoff.</p> | <div style="text-align: center;">  </div> |

Straw Bale (continued)

MAINTENANCE REQUIREMENTS

Straw bales shall be replaced if there are signs of degradation such as straw located downstream from the bales, structural deficiencies due to rotting straw in the bale, or other signs of deterioration. Sediment should be removed from behind the bales when it reaches a depth of approximately 6 inches.

NOTES

- The straw bale barrier must be entrenched, anchored, and backfilled. A trench should be excavated the width of a bale and the length of the proposed barrier to a minimum depth of 4 inches. After the bales are staked, the excavated soil must be backfilled against the barrier. Backfill soil should conform to the ground level on the downhill side and should be built up to 4 inches against the uphill side of the barrier.
- Each bale must be securely anchored by at least two wooden stakes driven toward the previously laid bale to force the bales together. Stakes should be driven 6–12 inches into the ground. Stakes should have a minimum diameter or cross section of 2 inches.
- All bales must be either wire-bound or string-tied.
- Fill gaps between bales by wedging with straw.
- Along toe of fills, install the straw bales along a level contour and leave enough area behind the barrier for runoff to pond and sediment to settle. A minimum of 5 feet away from the fill toe is recommended.
- Inspect frequently during construction. Repair or replacement should be made as promptly as needed.
- Remove sediment accumulated against the straw bale barrier when it reaches half the exposed barrier height.
- Remove bales after they have served their usefulness.
- Trenches where straw bales were located should be graded and stabilized.

Straw Bale (continued)

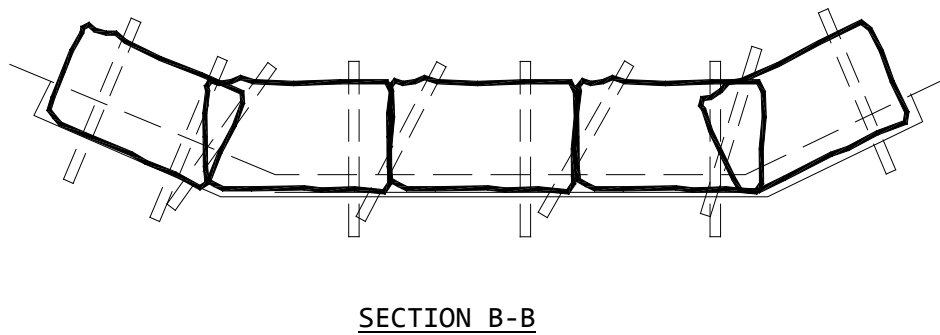
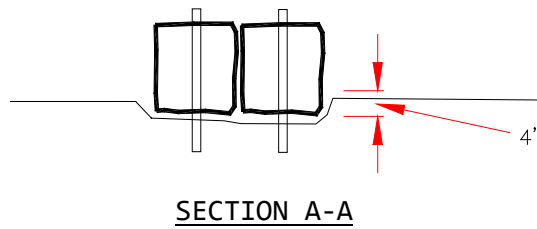
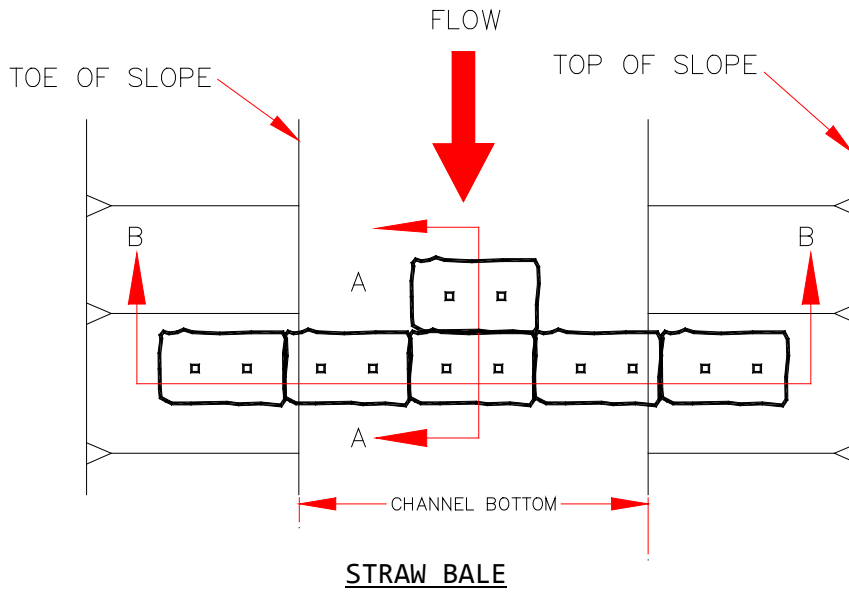

(This page intentionally blank)

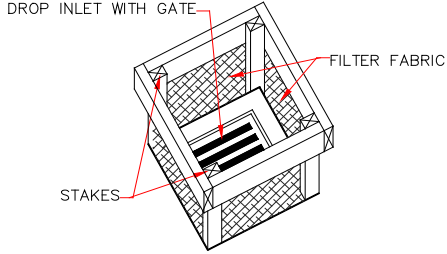
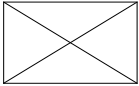
| | |
|--|---|
| <h2 style="text-align: center;">Drop Inlet Protection</h2> <div style="text-align: center;">  <p style="text-align: center;">TYPE I</p> </div> | <p style="text-align: center;">Applications</p> <ul style="list-style-type: none"> Perimeter Control Slope Protection ✓ Sediment Trapping Channel Protection Temporary Stabilization Permanent Stabilization Waste Management Housekeeping Practices |
| <p>DESCRIPTION</p> <p>A variety of drop inlet protection methods are used to intercept sediments at inlets through the use of stone, filter fabric, or other materials.</p> <p>PRIMARY USE</p> <p>Drop inlet protection is normally used as a second defense in site erosion control. A backup to onsite systems that have limited effectiveness.</p> <p>APPLICATIONS</p> <ul style="list-style-type: none"> • Filter barrier when site is less than one acre and slope is less than 5% • Block and gravel are used when flows exceed 0.5 cfs • Wire mesh and gravel are used where traffic crosses inlet <p>LIMITATIONS</p> <p>Ponding will occur at the inlet, with possible flooding as a result.</p> <p>Inlet protection is only viable at low-point inlets. Inlets that are on a slope cannot be effectively protected because storm water will bypass the inlet and continue downstream, causing an overload condition at inlets beyond.</p> <p>MAINTENANCE REQUIREMENTS</p> <p>Inspections should be made on a weekly basis, especially after large (>0.5 inches) storm events. When silt fence is used and the fabric becomes clogged, it should be cleaned or, if necessary, replaced. Also, sediment should be removed when it reaches approximately one-half the height of the fence. If a sump is used, sediment should be removed when the volume of the basin is reduced by 50%.</p> <p>For systems using stone filters, when the stone filter becomes clogged with sediment, the stones must be pulled away from the inlet and cleaned or replaced. Since cleaning of gravel at a construction site may be difficult, an alternative approach would be to use the clogged stone as fill material and put new stone around the inlet.</p> | <p style="text-align: center;">Targeted Constituents</p> <ul style="list-style-type: none"> ✓ Sediment Nutrients Toxic Materials Oil and Grease ✓ Floatable Materials Construction Wastes |
| | <p style="text-align: center;">Impact</p> <ul style="list-style-type: none"> ✓ Significant ✓ Medium Low Unknown or Questionable |
| |  |

Drop Inlet Protection (continued)

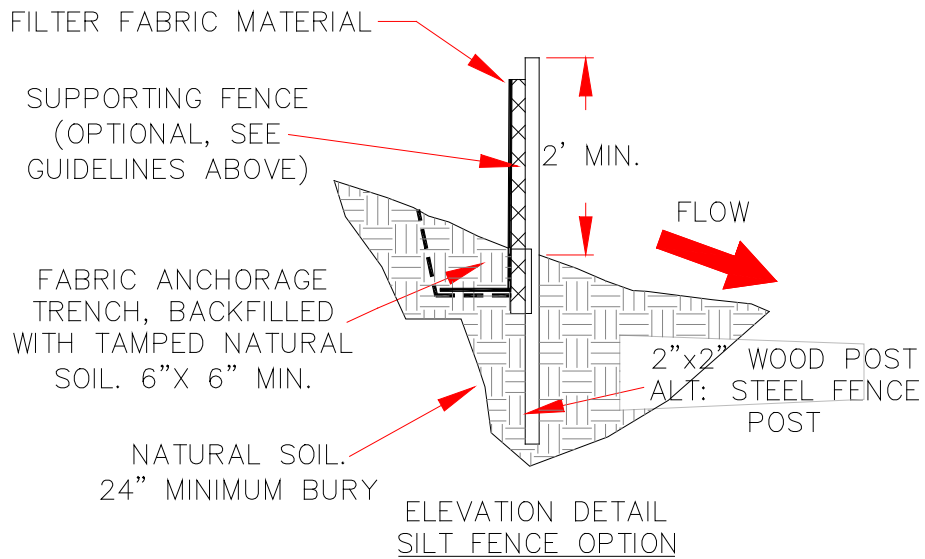

TYPE I

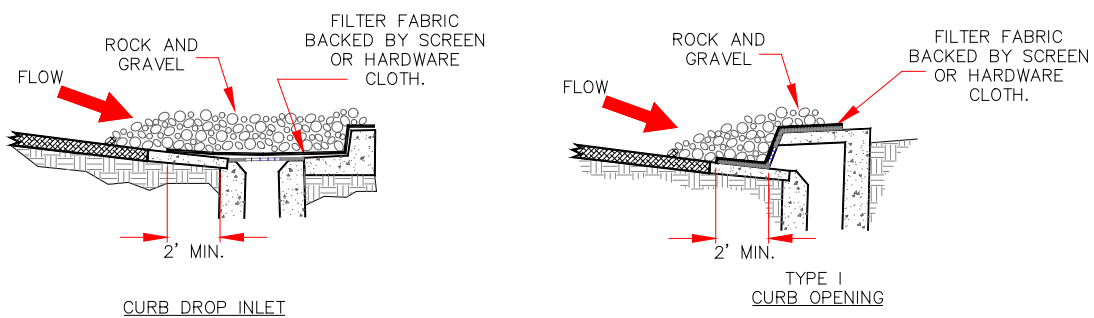

TYPE II

Drop Inlet Protection (continued)



Curb drop inlet protection in urban area – Type II



Drop inlet protection in urban area – Type I

(This page intentionally blank)

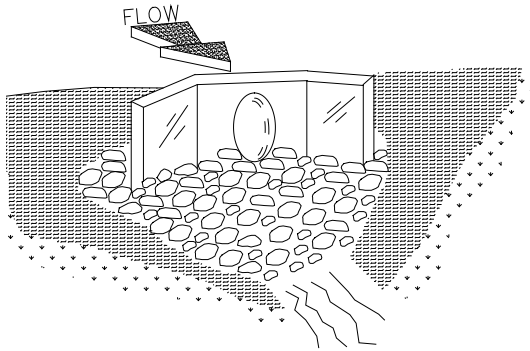
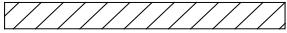
| | |
|---|---|
| <p>Culvert Protection</p>  | <p>Applications</p> <ul style="list-style-type: none"> Perimeter Control Slope Protection Sediment Trapping ✓ Channel Protection ✓ Temporary Stabilization Permanent Stabilization Waste Management Housekeeping Practices |
| <p>DESCRIPTION</p> <p>Culvert protection is a section of rock, riprap, or concrete rubble that protects the inlet and outlet end of culverts, conduits, or channels.</p> <p>PRIMARY USE</p> <p>Culvert protection is used to reduce the velocity and energy of flow such that the flow will not erode the receiving downstream reach.</p> <p>APPLICATIONS</p> <p>Culvert protection is use where velocities are high enough to cause downstream erosion. Easier to install and less expensive than concrete aprons or energy dissipators. Also serves to trap sediment and reduce velocities.</p> <p>LIMITATIONS</p> <p>Culvert protection may need continual maintenance because large storms often wash away the stone and leave the area susceptible to erosion. Grouted or wire-tied rock riprap can minimize maintenance requirements.</p> <p>MAINTENANCE REQUIREMENTS</p> <p>Inspect monthly and after each rainfall. Replace rocks as needed.</p> <p>For more information, refer to <i>Standard Specifications for Highway and Bridge Construction</i> (NMSHTD 2000).</p> | <p>Targeted Constituents</p> <ul style="list-style-type: none"> ✓ Sediment Nutrients Toxic Materials Oil and Grease Floatable Materials Construction Wastes <p>Impact</p> <ul style="list-style-type: none"> Significant ✓ Medium Low Unknown or Questionable |
| |  |

(This page intentionally blank)

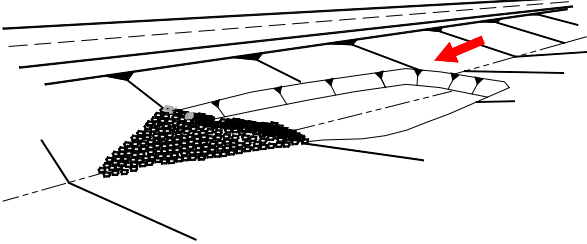
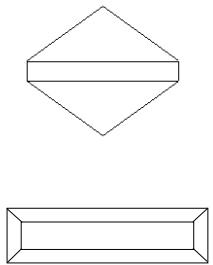
| | |
|--|---|
| <p style="text-align: center;">Sediment Trap – Berm/Excavated</p>  | <p style="text-align: center;">Applications</p> <ul style="list-style-type: none"> Perimeter Control Slope Protection ✓ Sediment Trapping Channel Protection Temporary Stabilization Permanent Stabilization Waste Management Housekeeping Practices |
| <p>DESCRIPTION</p> <p>A sediment trap is a small temporary ponding area with a gravel outlet, either excavated or formed by an embankment.</p> <p>PRIMARY USE</p> <p>Sediment traps are used to collect and store sediment from small sites cleaned or graded during construction. A temporary measure maintained until permanent measures are installed.</p> <p>APPLICATIONS</p> <p>Sediment traps are used where the site area is less than ten acres, usually installed in drainage way or point of discharge from disturbed area.</p> <p>LIMITATIONS</p> <p>There are limited applications for sediment traps due to the cost of construction, the availability of materials, and the amount of land required.</p> <p>Can cause minor flooding upstream of dam, impacting construction operations.</p> | <p style="text-align: center;">Targeted Constituents</p> <ul style="list-style-type: none"> ✓ Sediment Nutrients Toxic Materials Oil and Grease Floatable Materials Construction Wastes |
| <p>This technique serves as a temporary measure during construction. It should not be used for more than 18 months due to reduced efficiency.</p> <p>MAINTENANCE REQUIREMENTS</p> <p>Sediment shall be removed and the area directly behind the berm shall be re-graded to its original dimensions when the capacity of the impoundment has been reduced to one-half of its original storage capacity. The removed sediment shall be stockpiled or redistributed in areas that are protected from erosion.</p> <p>The stone outlet structure should be inspected frequently and after each major rain event to check for clogging of the void spaces between stones. If the aggregate appears to be silted in such that efficiency is diminished, the stone should be replaced.</p> | <p style="text-align: center;">Impact</p> <ul style="list-style-type: none"> Significant ✓ Medium Low Unknown or Questionable  |

Sediment Trap – Berm/Excavated (continued)

NOTES

- Traps should be located at points of discharge from disturbed areas.
- A rectangular and shallow trap with a length-to-width ratio of 2:1 or greater is recommended.
- Maximum embankment height shall be 5 feet measured on the downstream side. The minimum top embankment width shall be 4 feet. Side slopes for the embankment and the excavated areas shall be 2:1 or flatter.
- The outlet structure shall consist of a stone section in the embankment formed by a combination coarse aggregate/riprap to provide for filtering/detention capability. Riprap shall be 4 inches to 8 inches of rock, while the coarse aggregate shall be $\frac{1}{2}$ inch to $\frac{3}{4}$ inch.
- The outlet crest shall be at least 1 foot below the top of the embankment.
- The minimum outlet length in feet shall be 1.5 times the contributing drainage area to the trap.
- Sediment traps, along with other perimeter controls, shall be installed before any land disturbance takes place in the drainage area.
- A geotextile can be placed at the stone-soil interface to act as a separator.
- Sediment shall be removed from the trap when the wet storage volume is reduced by one half.
- Outlet structure should be regularly inspected; rocks clogged with sediment shall be cleaned or replaced.

Sediment Trap – Berm/Excavated (continued)

EARTH BERM

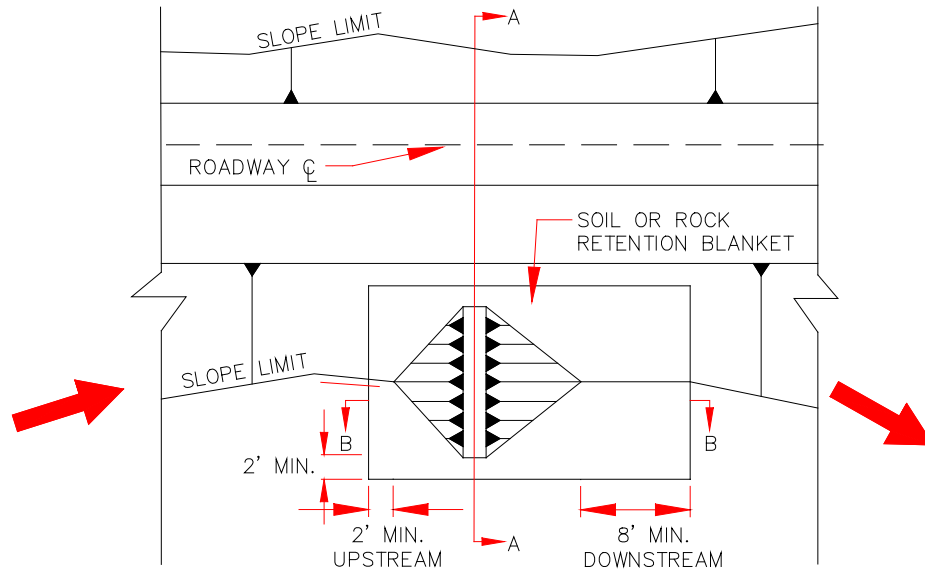

PLAN

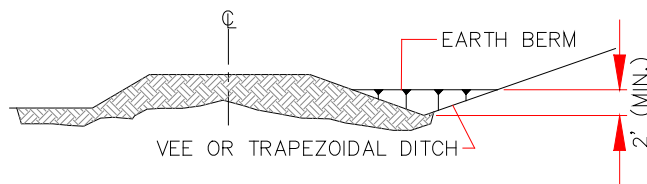

SECTION A-A

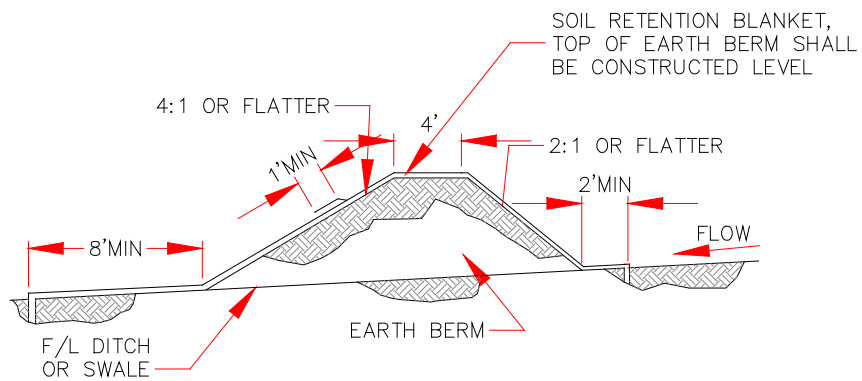

SECTION B-B

Sediment Trap – Berm/Excavated (continued)

EXCAVATED

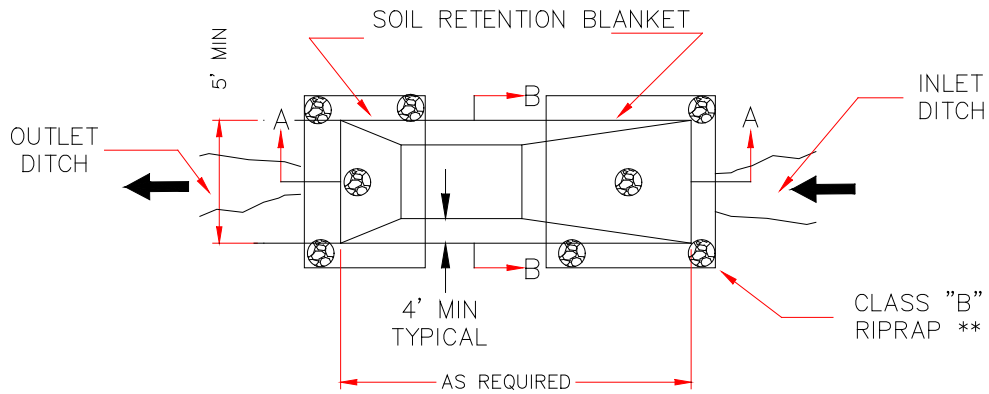

** NOTE: CLASS "B" RIPRAP INCIDENTAL TO PLACEMENT ON TEMPORARY SEDIMENT TRAP.

PLAN

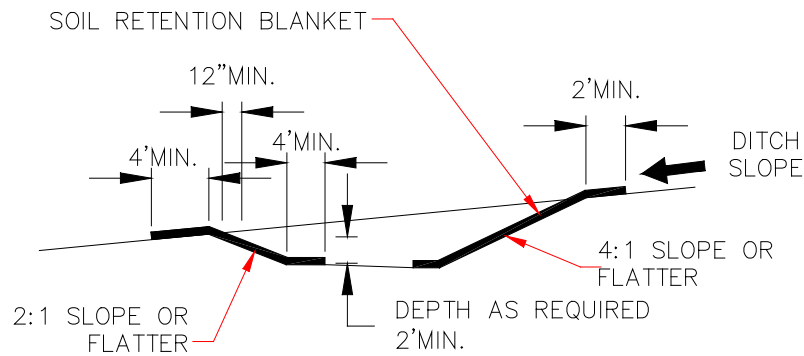

SECTION A-A

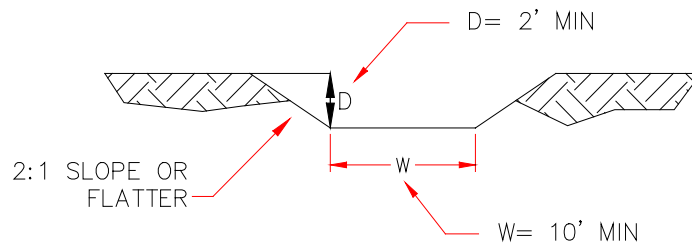

SECTION B-B

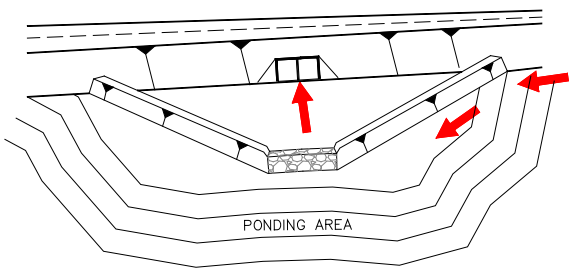
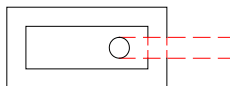
| | |
|--|---|
| <p>Sediment Basin</p>  | <p>Applications</p> <ul style="list-style-type: none"> Perimeter Control Slope Protection ✓ Sediment Trapping Channel Protection Temporary Stabilization Permanent Stabilization Waste Management Housekeeping Practices |
| <p>DESCRIPTION</p> <p>A sediment basin is a pond area with a controlled outlet in which suspended sediment is allowed to settle. Provides treatment plus controlled outflow, minimizing flood problems down gradient.</p> <p>PRIMARY USE</p> <p>Sediment basins should be used where there is adequate open space to direct most of the site drainage into the basin. For sites with disturbed areas of more than 10 acres that are part of the same drainage area, sediment basins are required as either temporary or permanent controls, if there are no site limitations.</p> <p>APPLICATIONS</p> <p>A sediment basin is a treatment device, highly effective for removing sediment and other pollutants for the design storm event. Sediment basins shall be designed for two-year storm runoff. Maximum embankment height shall be 9 feet with a minimum top width of 8 feet. The side slopes shall be 2:1 or flatter.</p> <p>LIMITATIONS</p> <p>Sediment basins can be rather large, depending on site conditions, requiring the use of expensive development area and comprehensive planning for construction phasing prior to implementation.</p> <p>Storm events that exceed the design storm event can cause damage to the spillway structure of the basin and may impact downstream concerns.</p> <p>MAINTENANCE REQUIREMENTS</p> <p>Sediment shall be removed and the basin shall be re-graded to its original dimensions when the capacity of the impoundment has been reduced to 20% of its original storage capacity. The removed sediment shall be stockpiled or redistributed in areas that are protected from erosion.</p> <p>The basin outlet structure and emergency spillway (if present) should be checked frequently and after each major rain event to inspect for damage and to insure that obstructions are not diminishing the effectiveness of the structures.</p> | <p>Targeted Constituents</p> <ul style="list-style-type: none"> ✓ Sediment Nutrients Toxic Materials Oil and Grease ✓ Floatable Materials Construction Wastes <p>Impact</p> <ul style="list-style-type: none"> ✓ Significant ✓ Medium Low Unknown or Questionable |
| |  |

Sediment Basin (continued)

EMERGENCY SPILLWAY SHOULD NOT BE
CONSTRUCTED OVER FILL MATERIAL.

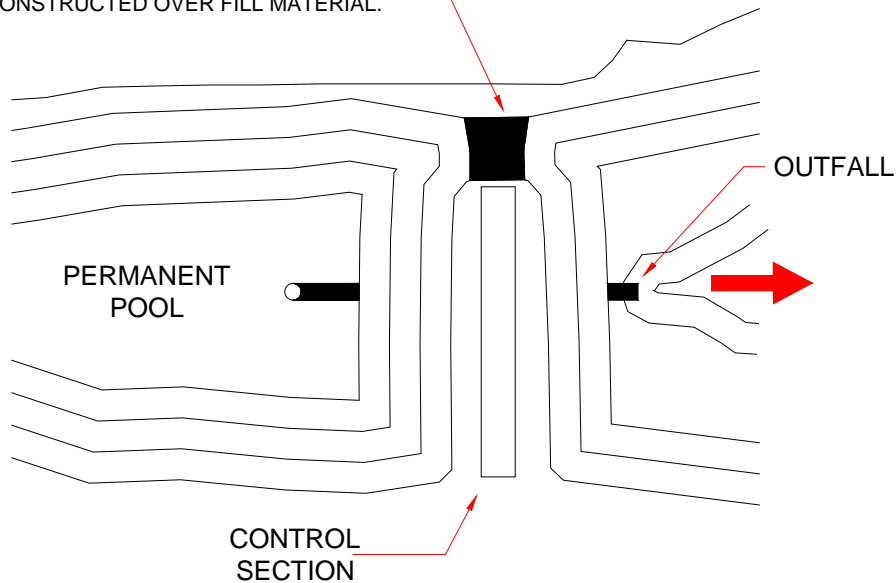

PLAN VIEW

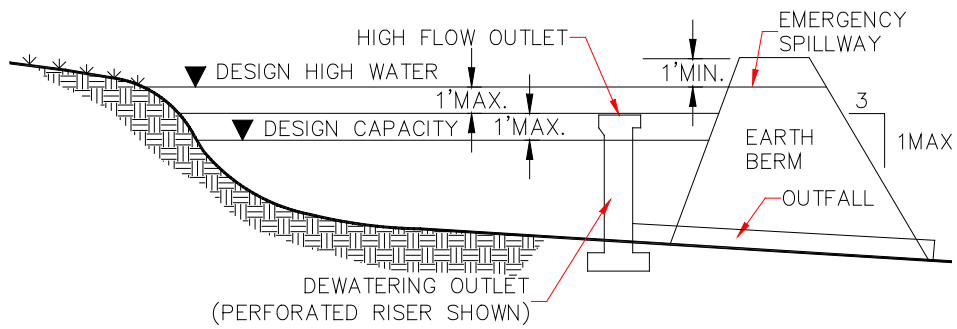



CROSS SECTION

Sediment Basin (continued)

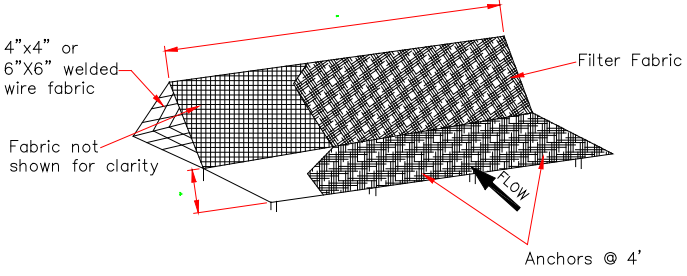

Sediment pond at inlet of box

(This page intentionally blank)

| <h2 style="text-align: center;">Triangular Sediment Filter Dike</h2> | <h3 style="text-align: center;">Applications</h3> <ul style="list-style-type: none"> ✓ Perimeter Control ✓ Slope Protection ✓ Sediment Trapping ✓ Channel Protection Temporary Stabilization Permanent Stabilization Waste Management Housekeeping Practices |
|--|--|
|  | <h3 style="text-align: center;">Targeted Constituents</h3> <ul style="list-style-type: none"> ✓ Sediment Nutrients Toxic Materials Oil and Grease ✓ Floatable Materials Construction Wastes |
| <p>DESCRIPTION</p> <p>A self-contained silt fence constructed of filter fabric wrapped around welded wire fabric, shaped into a triangular cross section. The dike is reusable, sturdy, and transportable. Can be used on paved or other areas where embedded posts cannot be used.</p> <p>PRIMARY USE</p> <p>Used in place of silt fences, treating sediment flow at the perimeter of construction areas site streams and as check dams on small scales. Useful on paved areas where silt fences or bales cannot be used.</p> <p>APPLICATIONS</p> <p>Useful for perimeter control by detaining sediment on disturbed areas and along stream banks. Can be used for control for more concentrated, higher, flow rates than silt fence.</p> <p>LIMITATIONS</p> <p>Ponding will likely occur directly adjacent to the dike, which may possibly cause flooding.</p> <p>Due to the potential for flow concentration and overtopping, triangular sediment filter dikes are not effective for conditions that include substantial concentrated flows or when they are not constructed along a contour line.</p> <p>MAINTENANCE REQUIREMENTS</p> <p>Inspections should be made on a weekly basis, especially after large (>0.5 inches) storm events. If the fabric becomes clogged, it should be cleaned or, if necessary, replaced.</p> <p>Sediment should be removed when it reaches approximately 6 inches in depth. In addition, inspections should be made on a regular basis to check the structural integrity of the dike. If structural deficiencies are found, the dike should be immediately repaired or replaced.</p> <p>As with silt fence, integrity of the filter fabric is important to the effectiveness of the dike. Overlap between dike sections must be checked on a regular basis and repaired if deficient.</p> | <h3 style="text-align: center;">Impact</h3> <ul style="list-style-type: none"> ✓ Significant ✓ Medium Low Unknown or Questionable |
| |  |

Triangular Sediment Filter Dike (continued)

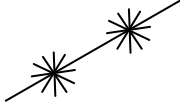

Triangular sediment filter dike

| Compost Filter Berm | Applications |
|--|--|
| <p>DESCRIPTION</p> <p>Compost filter berms are constructed of blown, scraped, or formed mass of ordinary compost material.</p> <p>PRIMARY USE</p> <p>As a check dam structure or to assist in relocating flows.</p> <p>APPLICATIONS</p> <p>Where low-density check dams or routing structures are required on a short-term basis.</p> <p>LIMITATIONS</p> <p>Not for use where through-flow can reach high-quality waters or where side velocity is great.</p> <p>MAINTENANCE REQUIREMENTS</p> <p>Must be periodically replaced for long-term use.</p> | <ul style="list-style-type: none"> ✓ Perimeter Control <li style="padding-left: 20px;">Slope Protection ✓ Sediment Trapping <li style="padding-left: 20px;">Channel Protection ✓ Temporary Stabilization <li style="padding-left: 20px;">Permanent Stabilization ✓ Waste Management <li style="padding-left: 20px;">Housekeeping Practices |
| | <p style="text-align: center;">Targeted Constituents</p> <ul style="list-style-type: none"> ✓ Sediment <li style="padding-left: 20px;">Nutrients <li style="padding-left: 20px;">Toxic Materials ✓ Oil and Grease ✓ Floatable Materials <li style="padding-left: 20px;">Construction Wastes |
| | <p style="text-align: center;">Impact</p> <ul style="list-style-type: none"> ✓ Significant ✓ Medium <li style="padding-left: 20px;">Low <li style="padding-left: 20px;">Unknown or Questionable |
| |  |

Compost Filter Berm (continued)



Compost berm under construction



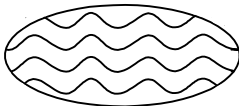

Compost berm

| | |
|--|---|
| <p>Straw Wattle</p> | <p>Applications</p> <ul style="list-style-type: none"> Perimeter Control ✓ Slope Protection ✓ Sediment Trapping Channel Protection ✓ Temporary Stabilization Permanent Stabilization Waste Management Housekeeping Practices |
| | <p>Targeted Constituents</p> <ul style="list-style-type: none"> ✓ Sediment Nutrients Toxic Materials ✓ Oil and Grease ✓ Floatable Materials Construction Wastes |
| | <p>Impact</p> <ul style="list-style-type: none"> ✓ Significant Medium Low Unknown or Questionable |
| |  |
| <p>DESCRIPTION</p> <p>Geotextile fabric cylinders filled with rice straw.</p> <p>PRIMARY USE</p> <p>Used on bare, steep slopes to control sediment movement.</p> <p>APPLICATIONS</p> <p>Use anywhere on slopes to limit the length of flow and velocity to prevent sediment transport.</p> <p>LIMITATIONS</p> <p>May be a proprietary product. May not be considered a permanent measure.</p> <p>MAINTENANCE REQUIREMENTS</p> <p>Must be periodically replaced for long-term use.</p> | |

Straw Wattle (continued)

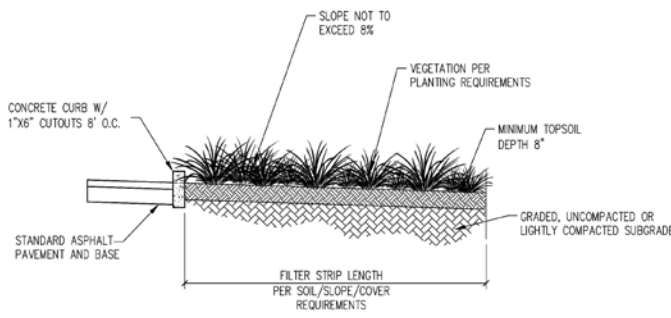

Straw wattles

| <h2>Filter Strips</h2> | <h3>Applications</h3> |
|--|--|
|  <p>The diagram illustrates a cross-section of a filter strip. On the left, a concrete curb with 1x6 inch outlets is shown. Below the curb is standard asphalt pavement and base. To the right of the curb is a sloped area covered with vegetation. The slope is labeled as 'SLOPE NOT TO EXCEED 8%'. Below the vegetation is a layer of 'MINIMUM TOPSOIL DEPTH 8\"'. The subgrade is labeled as 'GRADED, UNCOMPACTED OR LIGHTLY COMPACTED SUBGRADE'. A dimension line at the bottom indicates the 'FILTER STRIP LENGTH PER SOIL/SLOPE/COVER REQUIREMENTS'.</p> | <ul style="list-style-type: none"> Perimeter Control Slope Protection ✓ Sediment Trapping Channel Protection Temporary Stabilization ✓ Permanent Stabilization Waste Management Housekeeping Practices |
| <p>DESCRIPTION</p> <p>Vegetated filter strips (grassed filter strips, filter strips, and grassed filters) are vegetated surfaces that are designed to treat sheet flow from adjacent surfaces. Filter strips function by slowing runoff velocities and filtering out sediment and other pollutants, and by providing some infiltration into underlying soils.</p> | <h3>Targeted Constituents</h3> <ul style="list-style-type: none"> ✓ Sediment Nutrients Toxic Materials ✓ Oil and Grease Floatable Materials Construction Wastes |
| <p>PRIMARY USE</p> <p>Treatment of sheet flow from nearby and adjacent hardened surfaces. Primarily utilized for pretreatment of sheet flows and erosion protection at the edge of hardened surfaces. Can also provide modest infiltration and pollutant removal.</p> | <h3>Impact</h3> <ul style="list-style-type: none"> Significant Medium ✓ Low Unknown or Questionable |
| <p>APPLICATIONS</p> <p>Filter strips are best suited to treating runoff from roads and highways, roof downspouts, very small parking lots, and pervious surfaces. They are also ideal components of the "outer zone" of a stream buffer or as pretreatment to a structural practice.</p> <p>LIMITATIONS</p> <p>The practice has not been shown to achieve high pollutant removal.</p> <p>Filter strips require a large amount of space, typically equal to the impervious area they treat.</p> <p>Improper grading can render the practice ineffective in terms of pollutant removal.</p> <p>MAINTENANCE REQUIREMENTS</p> <p>Inspections should be made on an annual basis. Erosion or sediment deposition requires repair, and vegetation must be replanted if it is not thriving.</p> |  |

(This page intentionally blank)

| | |
|--|---|
| <p>Media Filter</p> <p style="text-align: center;">SAND BED PROFILE (TRENCH DESIGN)</p> | <p style="text-align: center;">Applications</p> <ul style="list-style-type: none"> Perimeter Control Slope Protection ✓ Sediment Trapping Channel Protection ✓ Temporary Stabilization ✓ Permanent Stabilization Waste Management Housekeeping Practices |
| <p>DESCRIPTION</p> <p>A filter bed filled with sand or gravel media utilized for removal of pollutants through filtration. Typical application includes a pretreatment settling pool to remove coarser materials and debris by settlement or screening.</p> | <p style="text-align: center;">Targeted Constituents</p> <ul style="list-style-type: none"> ✓ Sediment ✓ Nutrients Toxic Materials ✓ Oil and Grease Floatable Materials Construction Wastes |
| <p>PRIMARY USE</p> <p>Media Filters are used as filters to remove nutrients, some metals, BOD, suspended solids, and hydrocarbons from storm water flows.</p> | <p style="text-align: center;">Impact</p> <ul style="list-style-type: none"> ✓ Significant ✓ Medium Low Unknown or Questionable |
| <p>APPLICATIONS</p> <p>Media Filters are suitable for urban settings with high imperviousness. As they are subject to clogging, pretreatment is required where flows with high sediment loading. Best with urbanized paved areas. Especially effective in nutrient removals.</p> <p>LIMITATIONS</p> <p>Lack of adequate hydraulic head may result in standing water, potentially promoting mosquito breeding.</p> <p>Fairly expensive for a temporary construction phase BMP.</p> <p>Higher solids loading will clog filter.</p> <p>Heavy hydrocarbon loading can clog filter.</p> <p>MAINTENANCE REQUIREMENTS</p> <p>Inspections should be made on a monthly basis, especially after large storm events. If the filter becomes clogged, media may need to be screened or replaced.</p> | <p style="text-align: center;">MF</p> |

(This page intentionally blank)

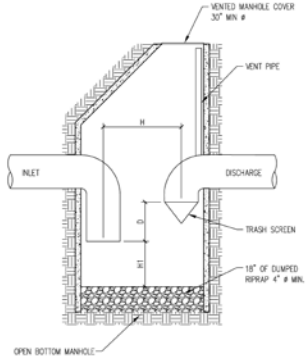
| | |
|---|--|
| <h2 style="text-align: center;">Mechanical Devices</h2>  <p>VENTED MANHOLE COVER 30" MIN #</p> <p>VENT PIPE</p> <p>INLET</p> <p>DISCHARGE</p> <p>TRASH SCREEN</p> <p>18" OF DUMPED RIPRAP 4" # MIN.</p> <p>OPEN BOTTOM MANHOLE</p> <p>H1. DEPENDENT UPON THE ENGINEER'S DETERMINATION OF THE ALLOWABLE AMOUNT OF SEDIMENT AND TRASH ACCUMULATION, SUPPORTING CALCULATIONS MUST BE SUPPLIED.</p> <p>H2. HORIZONTAL PATH LENGTH FOR AN AVERAGE PARTICLE</p> <p>H3. VERTICAL PATH LENGTH FOR AN AVERAGE PARTICLE</p> <p>H4. HORIZONTAL PATH LENGTH FOR AN AVERAGE PARTICLE IF THE INLET IS TANGENTIAL TO THE SPOOL, THEN THE HORIZONTAL PATH LENGTH MAY BE TAKEN AS THE CIRCUMFERENCE OF THE INSIDE OF THE SPOOL.</p> <p>H5. IT SHOULD BE NOTED THAT THIS DRAWING DEPICTED MINIMUM REQUIREMENT AND OTHER DESIGNS MAY BE CONSIDERED AS LONG AS THESE MINIMUM REQUIREMENTS ARE MET OR EXCEEDED.</p> | <h3 style="text-align: center;">Applications</h3> <ul style="list-style-type: none"> Perimeter Control Slope Protection ✓ Sediment Trapping Channel Protection Temporary Stabilization ✓ Permanent Stabilization Waste Management Housekeeping Practices |
| <h3>DESCRIPTION</h3> <p>A range of structural and mechanical devices exist to remove non-point source pollutants from storm water runoff. Regionally utilized devices include trash racks, baffle walls, screening systems, gravity separators, filters and hydrodynamic devices. Many devices are commercially available, and many local designs are available from as-built plans from local agencies.</p> <h3>PRIMARY USE</h3> <p>Mechanical devices are generally utilized to remove floatables, particulate contaminants including sediment, oil and grease, and litter and debris. They can provide specific area treatment for particular pollutants. The selection and design of an appropriate mechanical device should be carefully considered.</p> | <h3 style="text-align: center;">Targeted Constituents</h3> <ul style="list-style-type: none"> ✓ Sediment ✓ Nutrients Toxic Materials ✓ Oil and Grease ✓ Floatable Materials ✓ Construction Wastes |
| <h3>APPLICATIONS</h3> <p>Typically, mechanical devices are suitable for urban settings with high levels of sediment and debris. Appropriate locations may include parking lots, commercial developments, detention facilities, and locations where sheet flows are initially channelized.</p> | <h3 style="text-align: center;">Impact</h3> <ul style="list-style-type: none"> ✓ Significant ✓ Medium Low Unknown or Questionable |
| <h3>LIMITATIONS</h3> <p>Site conditions need to be matched to manufacturer's specifications.</p> <p>Fairly expensive BMP.</p> <p>Higher solids loading can render some devices ineffective.</p> <h3>MAINTENANCE REQUIREMENTS</h3> <p>Manufacturers generally provide maintenance schedules. Typical maintenance will require bi-weekly inspections, and post-construction applications may require bi-monthly inspections.</p> | <div style="border: 1px solid black; padding: 20px; font-size: 48px; font-weight: bold; width: 100px; margin: 0 auto;">MD</div> |

(This page intentionally blank)

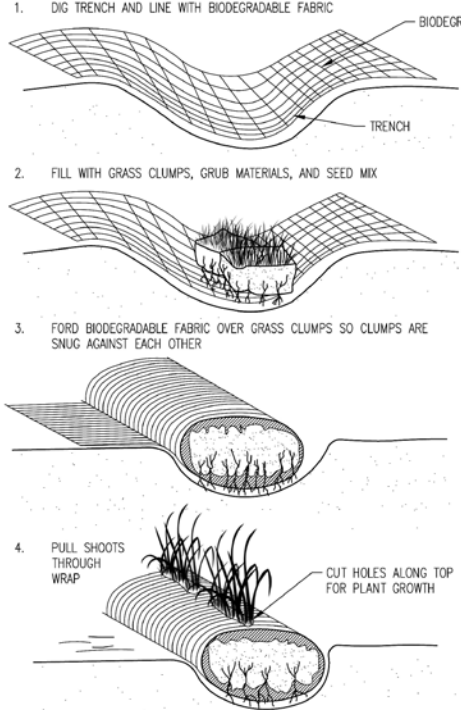
| <h2 style="text-align: center;">Live Wattles</h2> | <h3 style="text-align: center;">Applications</h3> |
|--|--|
|  <p>1. DIG TRENCH AND LINE WITH BIODEGRADABLE FABRIC</p> <p>2. FILL WITH GRASS CLUMPS, GRUB MATERIALS, AND SEED MIX</p> <p>3. FOLD BIODEGRADABLE FABRIC OVER GRASS CLUMPS SO CLUMPS ARE SNUG AGAINST EACH OTHER</p> <p>4. PULL SHOOTS THROUGH WRAP</p> | <ul style="list-style-type: none"> Perimeter Control Slope Protection ✓ Sediment Trapping Channel Protection ✓ Temporary Stabilization ✓ Permanent Stabilization Waste Management Housekeeping Practices |
| | <h3 style="text-align: center;">Targeted Constituents</h3> <ul style="list-style-type: none"> ✓ Sediment Nutrients Toxic Materials ✓ Oil and Grease Floatable Materials Construction Wastes |
| <p>DESCRIPTION</p> <p>A filter wattle filled with a blend of onsite clear and grubbed materials, and possibly seed mixture, wrapped in filter cloth and utilized for removal of pollutants through filtration and sedimentation.</p> <p>PRIMARY USE</p> <p>Live Wattles are used as a linear control BMP to promote continued vegetative growth. Used to slow, filter, and spread overland flows. Can be installed on slopes with careful design and redundancy.</p> | <h3 style="text-align: center;">Impact</h3> <ul style="list-style-type: none"> Significant ✓ Medium Low Unknown or Questionable |
| <p>APPLICATIONS</p> <p>Can be suitable for: toe, top, face, of shallow slopes, along the perimeter of a project, as check dams in unlined ditches, downslope of exposed soil areas, and around temporary stockpiles.</p> <p>LIMITATIONS</p> <p>Are not effective unless trenched.</p> <p>Can be disturbed or moved by high flows.</p> <p>MAINTENANCE REQUIREMENTS</p> <p>Inspections should be made on a bi-weekly basis, and may require reconstruction if undermined or eroded.</p> | <div style="border: 1px solid black; border-radius: 50%; width: 40px; height: 40px; margin: 0 auto; display: flex; align-items: center; justify-content: center;"> LW </div> |

(This page intentionally blank)

Appendix A5

Good Housekeeping / Materials Management

- Sanitary Facilities
- Equipment Maintenance
- Protected Chemical and Materials Storage Areas
- Spill Prevention Plan
- Protection of Trees
- Concrete Waste Management
- Solid Waste Management
- Hazardous Waste Management
- Stabilized Construction Entrance/Exit

(This page intentionally blank)

Good Housekeeping / Materials Management

(This page intentionally blank)

Good Housekeeping / Materials Management

CONTENTS

| BMP | Page |
|--|-------------|
| Symbol..... | A5-2 |
| Sanitary Facilities | A5-3 |
| Equipment Maintenance..... | A5-5 |
| Protected Chemical and Materials Storage Areas | A5-7 |
| Spill Prevention Plan | A5-9 |
| Protection of Trees..... | A5-11 |
| Concrete Waste Management..... | A5-13 |
| Solid Waste Management | A5-15 |
| Hazardous Waste Management | A5-17 |
| Stabilized Construction Entrance/Exit..... | A5-19 |

SYMBOL

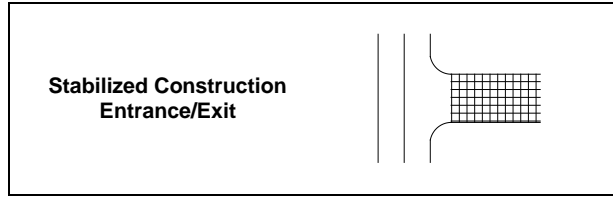

| Sanitary Facilities | Applications |
|--|---|
| <p>DESCRIPTION</p> <p>Portable sanitary facilities that store sanitary waste should be emptied periodically, kept clean, and stocked with supplies.</p> <p>PRIMARY USE</p> <p>Sanitary facilities prevent onsite disposal of sanitary wastes or illicit discharges.</p> <p>APPLICATIONS</p> <p>Sanitary facilities are required for all work sites or construction areas. Domestic waste haulers should be contracted to regularly remove wastes and maintain facilities in good working order.</p> | <p>Perimeter Control</p> <p>Slope Protection</p> <p>Sediment Trapping</p> <p>Channel Protection</p> <p>Temporary Stabilization</p> <p>Permanent Stabilization</p> <p>✓ Waste Management</p> <p>✓ Housekeeping Practices</p> |
| | <p>Targeted Constituents</p> <p>Sediment</p> <p>Nutrients</p> <p>Toxic Materials</p> <p>Oil and Grease</p> <p>Floatable Materials</p> <p>Construction Wastes</p> |
| | <p>Impact</p> <p>✓ Significant</p> <p>Medium</p> <p>Low</p> <p>Unknown or Questionable</p> |

(This page intentionally blank)

| Equipment Maintenance | Applications |
|---|---|
| <p>DESCRIPTION</p> <p>Establishment of a program of equipment maintenance procedures will reduce contamination of onsite soils.</p> <p>PRIMARY USE</p> <p>Non-sediment storm water pollution can occur through improper disposal of equipment fluids, filters, batteries, and tires. Proper equipment maintenance can prevent this kind of pollution.</p> <p>APPLICATIONS</p> <p>Equipment maintenance is important for large construction sites where heavy equipment storage, truck storage, and maintenance yards are located onsite.</p> | <p>Perimeter Control</p> <p>Slope Protection</p> <p>Sediment Trapping</p> <p>Channel Protection</p> <p>Temporary Stabilization</p> <p>Permanent Stabilization</p> <p>✓ Waste Management</p> <p>✓ Housekeeping Practices</p> <p>Targeted Constituents</p> <p>Sediment</p> <p>Nutrients</p> <p>✓ Toxic Materials</p> <p>✓ Oil and Grease</p> <p>Floatable Materials</p> <p>Construction Wastes</p> |
| | <p>Impact</p> <p>✓ Significant</p> <p>Medium</p> <p>Low</p> <p>Unknown or Questionable</p> |
| | |

(This page intentionally blank)

| | |
|---|---|
| <p>Protected Chemical and Materials Storage Areas</p> | <p>Applications</p> <ul style="list-style-type: none"> Perimeter Control Slope Protection Sediment Trapping Channel Protection Temporary Stabilization Permanent Stabilization ✓ Waste Management ✓ Housekeeping Practices |
| <p>DESCRIPTION</p> <p>Construction materials and chemicals should be sheltered in covered storage areas that has a spill-proof perimeter around it.</p> <p>PRIMARY USE</p> <p>Rain can wash pollutants from improperly stored materials into local drainage systems. By properly covering and storing chemicals, materials, and waste containers so that they are protected from rainwater, non-sediment pollution of storm water can be prevented.</p> <p>APPLICATIONS</p> <p>Locate chemical storage areas away from low-lying areas, drainage ways, and stream banks.</p> | <p>Targeted Constituents</p> <ul style="list-style-type: none"> Sediment ✓ Nutrients ✓ Toxic Materials ✓ Oil and Grease Floatable Materials ✓ Construction Wastes |
| | <p>Impact</p> <ul style="list-style-type: none"> ✓ Significant Medium Low Unknown or Questionable |
| | |

(This page intentionally blank)

| Spill Prevention Plan | Applications |
|--|---|
| <p>DESCRIPTION</p> <p>The Spill Prevention Plan is an emergency plan to contain spills of dangerous, hazardous, or toxic wastes that mitigates environmental damage and provides prompt notice to proper authorities.</p> <p>PRIMARY USE</p> <p>The Spill Prevention Plan shall include measures to limit the scope of the spill and minimize environmental damage.</p> <p>APPLICATIONS</p> <p>Spill Prevention Plans are applicable to all construction sites. Those sites closest to watercourses, canals, and reservoirs are at highest risk of contaminating surface waters with an uncontained spill.</p> <p>NOTES</p> <ul style="list-style-type: none"> • Select a designated area for storage. • All containers must be tightly sealed and labeled. • Storage areas should be surrounded by a berm. Construct berms to provide a storage volume of no less than 1.5 times the total volume of the stored material. • Cleanup procedures should be clearly posted and cleanup materials should be readily available. • Storage area should be covered and lined with an impermeable liner. • If a spill occurs, the source of the spill should be stopped as practicable. The spill should be covered with an absorbent material. • Dispose of any contaminated material in accordance with state or local requirements. • Do not store chemicals or hazardous substances within 50 feet of any receiving water. <p>In the event of a spill of a hazardous substance, notify the National Response Center (NRC) at (800) 424-8802, the New Mexico Environment Department (NMED) at (505) 827-9329, and the local fire department.</p> | <p>Perimeter Control</p> <p>Slope Protection</p> <p>Sediment Trapping</p> <p>Channel Protection</p> <p>Temporary Stabilization</p> <p>Permanent Stabilization</p> <p>✓ Waste Management</p> <p>✓ Housekeeping Practices</p> |
| | <p>Targeted Constituents</p> <p>Sediment</p> <p>Nutrients</p> <p>✓ Toxic Materials</p> <p>✓ Oil and Grease</p> <p>Floatable Materials</p> <p>Construction Wastes</p> |
| | <p>Impact</p> <p>✓ Significant</p> <p>Medium</p> <p>Low</p> <p>Unknown or Questionable</p> |
| | |

(This page intentionally blank)

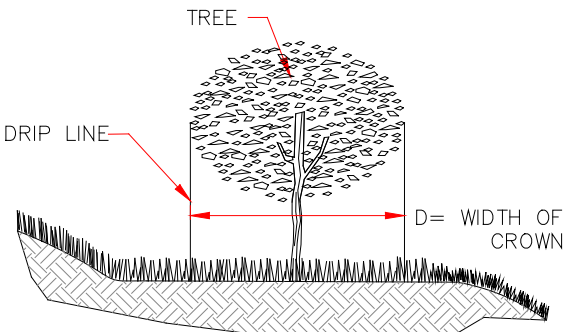
| <h2 style="text-align: center;">Protection of Trees</h2> | |
|---|--|
| <p>DESCRIPTION</p> <p>Trees can provide superior, low-maintenance, and long-term erosion protection. They are also useful for site aesthetics.</p> <p>PRIMARY USE</p> <p>Preserving and protecting trees can result in a more stable and aesthetically pleasing development. Trees stabilize the soil and help prevent erosion, decrease storm water runoff, moderate temperatures, provide buffers and screens, filter pollutants from the air, supply oxygen, provide wildlife habitat, and increase property values.</p> <p>APPLICATIONS</p> <p>Trees are desirable on steep or rocky slopes where mowing is not feasible; where ornamentals are desired for landscaping purposes; and where woody plants are desired for soil conservation or for establishment or maintenance of wildlife habitats.</p> <p>NOTES</p> <ul style="list-style-type: none"> • Mark trees to be protected at a height visible to equipment operators. • Equipment operators shall not clean their equipment by slamming it against the protected trees. • Roots, trunk, and tops of trees can be protected by fencing. The fence shall be erected at the tree drip line. • Limits for clearing must be located at the tree drip line. • Trenching shall always be performed as far away from trees as possible. Consider tunneling as an option. • Damaged trees should be repaired. Appropriate repairs should be prescribed by a forester or a tree specialist. | <p style="text-align: center;">Applications</p> <p>Perimeter Control</p> <p>✓ Slope Protection</p> <p>Sediment Trapping</p> <p>Channel Protection</p> <p>✓ Temporary Stabilization</p> <p>✓ Permanent Stabilization</p> <p>Waste Management</p> <p>Housekeeping Practices</p> |
| | <p style="text-align: center;">Targeted Constituents</p> <p>Sediment</p> <p>Nutrients</p> <p>Toxic Materials</p> <p>Oil and Grease</p> <p>Floatable Materials</p> <p>Construction Wastes</p> |
| | <p style="text-align: center;">Impact</p> <p>✓ Significant</p> <p>✓ Medium</p> <p>Low</p> <p>Unknown or Questionable</p> |
| <div style="text-align: center;">  </div> | |

(This page intentionally blank)

| Concrete Waste Management | |
|---|--|
| <p>DESCRIPTION</p> <p>Concrete waste management prevents or reduces the discharge of pollutants to storm water by conducting washout offsite, performing onsite washout in a designated area, and training employees and subcontractors.</p> <p>APPLICATIONS</p> <p>The following low-cost measures will help reduce storm water pollution from concrete wastes:</p> <ul style="list-style-type: none"> • Store dry and wet materials under cover, away from drainage areas. • Avoid mixing excess amounts of fresh concrete or cement onsite. • Perform washout of concrete trucks offsite or in designated areas only. • Do not wash out concrete trucks into storm drains, open ditches, streets, or streams. • Do not allow excess concrete to be dumped onsite except in designated areas. • For onsite washout: <ul style="list-style-type: none"> ☒ Locate washout area at least 50 feet from storm drains, open ditches, or water bodies. Prevent runoff from this area by constructing a temporary pit or bermed area large enough for liquid and solid waste. ☒ Wash out wastes into the temporary pit where the concrete can set, be broken up, and then disposed of properly. • When washing concrete to remove fine particles and expose the aggregate, avoid creating runoff by draining the water to a bermed or level area. • Do not wash sweepings from exposed aggregate concrete into the street or storm drain. Collect and return sweepings to aggregate base stock pile, or dispose in the trash. • Train employees and subcontractors in proper concrete waste management. <p>LIMITATIONS</p> <p>Offsite washout of concrete wastes may not always be possible.</p> <p>MAINTENANCE REQUIREMENTS</p> <p>Inspect subcontractors to ensure that concrete wastes are being properly managed.</p> <p>If using a temporary pit, dispose of hardened concrete on a regular basis.</p> | <p style="text-align: center;">Applications</p> <p>Perimeter Control</p> <p>Slope Protection</p> <p>Sediment Trapping</p> <p>Channel Protection</p> <p>Temporary Stabilization</p> <p>Permanent Stabilization</p> <p>✓ Waste Management</p> <p>✓ Housekeeping Practices</p> <hr/> <p style="text-align: center;">Targeted Constituents</p> <p>Sediment</p> <p>Nutrients</p> <p>Toxic Materials</p> <p>Oil and Grease</p> <p>Floatable Materials</p> <p>✓ Construction Wastes</p> <hr/> <p style="text-align: center;">Impact</p> <p>Significant</p> <p>✓ Medium</p> <p>Low</p> <p>Unknown or Questionable</p> |

(This page intentionally blank)

| Solid Waste Management | Applications |
|---|--|
| <p>DESCRIPTION</p> <p>Prevent or reduce the discharge of pollutants to storm water from solid or construction waste by providing designated waste collection areas and containers, arranging for regular disposal, and training employees and subcontractors.</p> <p>APPLICATIONS</p> <p>Solid waste is one of the major pollutants resulting from construction. Construction debris includes:</p> <ul style="list-style-type: none"> • Solid waste generated from trees and shrubs removed during land clearing, demolition of existing structures (rubble), and building construction • Packaging materials including wood, paper, and plastic • Scrap or surplus building materials including scrap metals, rubber, plastic, glass pieces, and masonry products • Domestic wastes, including food containers such as beverage cans, coffee cups, paper bags, plastic wrappers, and cigarettes <p>The following low-cost measures will help keep a clean site and reduce storm water pollution:</p> <ul style="list-style-type: none"> • Select designated waste collection areas onsite. • Inform trash-hauling contractors that you will accept only watertight dumpsters for onsite use. Inspect dumpsters for leaks and repair any dumpsters that are not watertight. • Locate containers in a covered area and/or in a secondary containment. • Provide an adequate number of containers with lids or covers that can be placed over the containers to keep rain out or to prevent loss of waste during windy conditions. • Plan for additional containers and more frequent pickup during the demolition phase of construction. • Collect site trash daily, especially during rainy and windy conditions. • Erosion and sediment control devices tend to collect litter. Remove this solid waste promptly. • Make sure that toxic liquid wastes (used oils, solvents, paints) and chemicals (acids, pesticides, additives, curing compounds) are not disposed of in dumpsters designated for construction debris. | <p>Sediment</p> <p>Slope Protection</p> <p>Sediment Trapping</p> <p>Channel Protection</p> <p>Temporary Stabilization</p> <p>Permanent Stabilization</p> <p>✓ Waste Management</p> <p>✓ Housekeeping Practices</p> <p>Targeted Constituents</p> <p>Sediment</p> <p>Nutrients</p> <p>Toxic Materials</p> <p>Oil and Grease</p> <p>Floatable Materials</p> <p>✓ Construction Wastes</p> |
| | <p>Impact</p> <p>✓ Significant</p> <p>Medium</p> <p>Low</p> <p>Unknown or Questionable</p> |
| | |

Solid Waste Management (continued)

- Salvage or recycle any useful material. For example, trees and shrubs from land clearing can be used as a brush barrier or converted into wood chips and used as mulch on graded areas.
- Do not hose out dumpsters on the construction site. Leave dumpster cleaning to the trash hauling contractor.
- Arrange for regular waste collection before containers overflow.
- If a container does spill, clean it up immediately.
- Make sure that construction waste is collected, removed, and disposed of only at authorized disposal areas.
- Train employees and subcontractors in proper solid waste management.

LIMITATIONS

No major limitations.

MAINTENANCE REQUIREMENTS

- Collect site trash daily.
- Inspect construction waste area regularly.
- Arrange for regular waste collection.

| Hazardous Waste Management | |
|---|--|
| <p>DESCRIPTION</p> <p>Prevent or reduce the discharge of pollutants to storm water from hazardous waste through proper material use, waste disposal, and training of employees and subcontractors.</p> <p>APPLICATIONS</p> <p>Many of the chemicals used onsite can be hazardous materials that become hazardous waste upon disposal. These wastes may include:</p> <ul style="list-style-type: none"> • Paints and solvents • Petroleum products such as oils, fuels, and grease • Herbicides and pesticides • Acids for cleaning masonry • Concrete-curing compounds <p>In addition, sites with existing structures may contain wastes that must be disposed of in accordance with federal, state, and local regulations. These wastes include:</p> <ul style="list-style-type: none"> • Sandblasting grit mixed with lead-, cadmium-, or chromium-based paints • Asbestos • Polychlorinated biphenyls (PCBs) (particularly in older transformers) <p>The following low-cost measures will help reduce storm water pollution from hazardous wastes:</p> <p><i>Material Use</i></p> <ul style="list-style-type: none"> • Use all of the product before disposing of the container. • Do not remove the original product label. It contains important safety and disposal information. • Do not over-apply herbicides and pesticides. Prepare only the amount needed. Follow the recommended usage instructions. Over-application is expensive and environmentally harmful. Apply surface dressings in several smaller applications, as opposed to one large application, to allow time for infiltration and to avoid excess material being carried offsite by runoff. Do not apply these chemicals just before it rains. People applying pesticides must be certified in accordance with federal and state regulations. • Do not clean out brushes or rinse paint containers into the dirt, gutter, storm drain, or stream. "Paint out" brushes as much as possible. Rinse water-based paints to the sanitary sewer. Filter and reuse thinners and solvents. Dispose of excess oil-based paints and sludge as hazardous waste. | <p style="text-align: center;">Applications</p> <p>Perimeter Control</p> <p>Slope Protection</p> <p>Sediment Trapping</p> <p>Channel Protection</p> <p>Temporary Stabilization</p> <p>Permanent Stabilization</p> <p>✓ Waste Management</p> <p>Housekeeping Practices</p> <hr/> <p style="text-align: center;">Targeted Constituents</p> <p>Sediment</p> <p>Nutrients</p> <p>✓ Toxic Materials</p> <p>Oil and Grease</p> <p>Floatable Materials</p> <p>Construction Wastes</p> <hr/> <p style="text-align: center;">Impact</p> <p>✓ Significant</p> <p>Medium</p> <p>Low</p> <p>Unknown or Questionable</p> |

Hazardous Waste Management (continued)

Waste Recycling/Disposal

- Select designated hazardous waste collection areas onsite.
- Hazardous materials and wastes should be stored in covered containers and protected from vandalism.
- Place hazardous waste containers in secondary containment.
- Do not mix wastes. This can cause chemical reactions, make recycling impossible, and complicate disposal.
- Recycle any useful material such as used oil or water-based paint.
- Make sure that toxic liquid wastes (used oils, solvents, paints) and chemicals (acids, pesticides, additives, curing compounds) are not disposed of in dumpsters designated for construction debris.
- Arrange for regular waste collection before containers overflow.
- Make sure that hazardous waste (e.g. excess oil-based paint and sludges) is collected, removed, and disposed of only at authorized disposal areas.

LIMITATIONS

A licensed hazardous waste hauler must dispose of hazardous waste that cannot be reused or recycled.

MAINTENANCE REQUIREMENTS

- Inspect hazardous waste receptacles and area regularly.
- Arrange for regular hazardous waste collection.

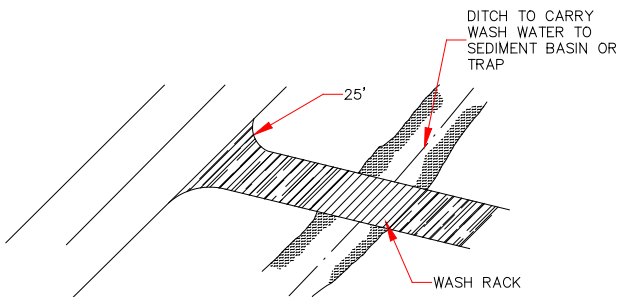
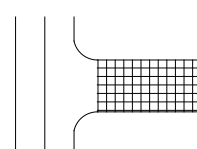
| <h2 style="text-align: center;">Stabilized Construction Entrance/Exit</h2> | |
|---|---|
|  <p>DITCH TO CARRY WASH WATER TO SEDIMENT BASIN OR TRAP</p> <p>25'</p> <p>WASH RACK</p> | <p style="text-align: center;">Applications</p> <ul style="list-style-type: none"> Perimeter Control Slope Protection Sediment Trapping Channel Protection ✓ Temporary Stabilization Permanent Stabilization Waste Management Housekeeping Practices |
| <p>DESCRIPTION</p> <p>A stabilized construction entrance consists of a pad of crushed stone, recycled concrete, or other rock-like material on top of a geotextile filter cloth, which is used to facilitate the washdown and removal of sediment and other debris from construction equipment prior to exiting the site. During the construction phase of a project, regular street sweeping should be performed to remove debris carried from the site.</p> <p>PRIMARY USE</p> <p>Stabilized construction entrances are used to reduce offsite sediment tracking from trucks and construction equipment, and for sites where considerable truck traffic occurs each day. They also reduce the need to clean adjacent pavement as often, and help route site traffic through a single point.</p> <p>APPLICATIONS</p> <p>As a part to the erosion-control plan required for sites larger than five acres, and recommended for all construction sites.</p> <p>LIMITATIONS</p> <p>Selection of the construction entrance location is critical. To be effective, it must be used exclusively.</p> <p>Stabilized entrances are rather expensive, considering that they must be installed in combination with one or more other sediment control techniques. It may be more cost effective, however, than labor-intensive street cleaning.</p> <p>MAINTENANCE REQUIREMENTS</p> <p>Inspections should be made on a regular basis and after large storm events in order to ascertain whether or not sediment and pollution are being effectively detained on site.</p> <p>When sediment has substantially clogged the void area between the rocks, the aggregate mat must be washed down or replaced.</p> <p>Periodic re-grading and top dressing with additional stone must be done to keep the efficiency of the entrance from diminishing.</p> | <p style="text-align: center;">Targeted Constituents</p> <ul style="list-style-type: none"> ✓ Sediment Nutrients Toxic Materials Oil and Grease Floatable Materials Construction Wastes <p style="text-align: center;">Impact</p> <ul style="list-style-type: none"> ✓ Significant ✓ Medium Low Unknown or Questionable |
| |  |

Stabilized Construction Entrance/Exit (continued)

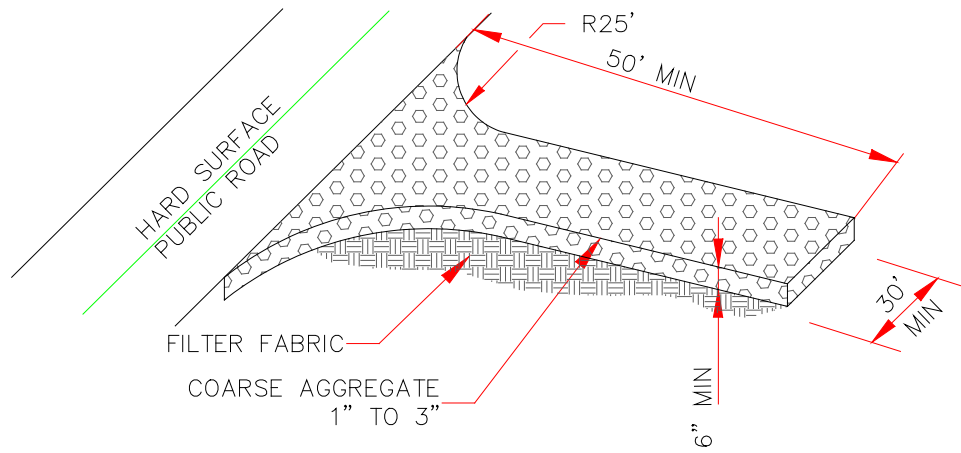
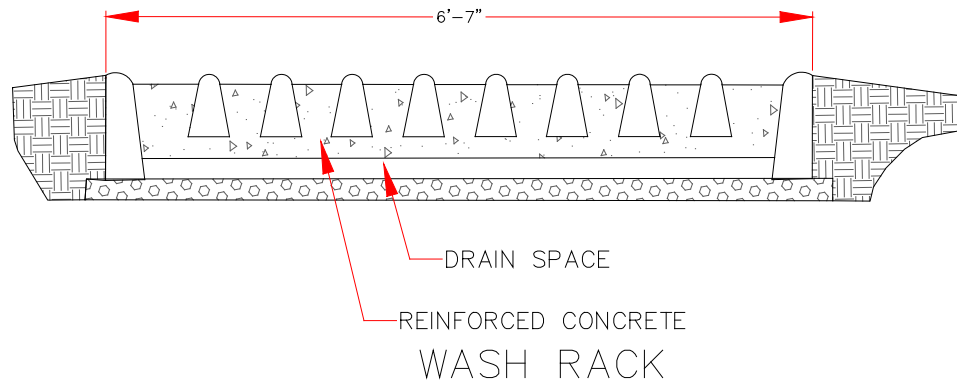

Appendix A6

Post-Construction Phase BMPs

- Below Grade Storage
- Green Parking
- Alternative Pavers
- Street Design and Patterns
- Urban Forestry

(This page intentionally blank)

Post-Construction Phase BMPs

(This page intentionally blank)

Post-Construction Phase BMPs

TABLE OF CONTENTS

| BMP | Page |
|---------------------------------|-------------|
| Symbols | A6-2 |
| Below Grade Storage | A6-3 |
| Green Parking | A6-5 |
| Alternative Pavers | A6-7 |
| Street Design and Patterns..... | A6-9 |
| Urban Forestry | A6-11 |

SYMBOLS

| | |
|---------------------------|--|
| Below Grade Storage | |
| Alternative Pavers | |
| Urban Forestry | |
| Diversion Channel (Swale) | |
| Slope Drain | |
| Drop Inlet Protection | |
| Culvert Protection | |

| | |
|---------------------------------|--|
| Green Parking | |
| Street Design and Patterns | |
| Sediment Trap, Excavated | |
| Sediment Basin | |
| Triangular Sediment Filter Dike | |
| Compost Filter Berm | |
| Straw Wattle | |

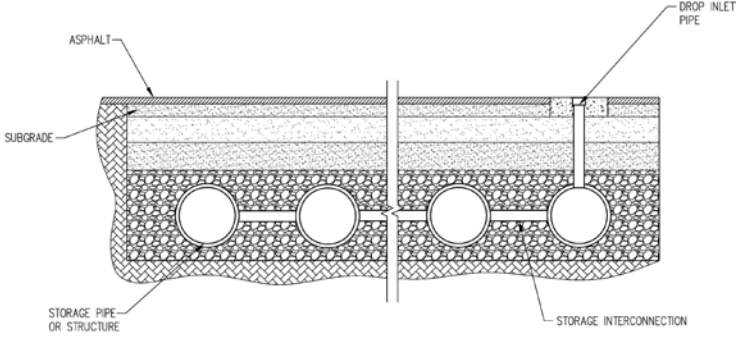
| <h2 style="text-align: center;">Below Grade Storage</h2> | | <h3 style="text-align: center;">Applications</h3> |
|---|--|---|
|  | <ul style="list-style-type: none"> Perimeter Control Slope Protection ✓ Sediment Trapping Channel Protection ✓ Temporary Stabilization ✓ Permanent Stabilization Waste Management Housekeeping Practices | |
| <p>DESCRIPTION</p> <p>Below Grade Storage can be utilized as a detention system with perforated pipes or direct infiltration into ground, or can be utilized in high pollutant areas as retention facilities for zero-discharge facilities.</p> <p>PRIMARY USE</p> <p>Utilized in urban dense development locations where surface area may not be available for storm water facilities. Also utilized for industrial facilities where zero discharge is required and pumping truck removal of Stormwater is desired.</p> | <h3 style="text-align: center;">Targeted Constituents</h3> <ul style="list-style-type: none"> ✓ Sediment ✓ Nutrients Toxic Materials ✓ Oil and Grease Floatable Materials Construction Wastes | |
| <p>APPLICATIONS</p> <p>Below Grade Storage is utilized in parking lots, industrial areas, or other urban locations with low sediment loads and lack of available surface area.</p> <p>LIMITATIONS</p> <p>Difficult to inspect and maintain. Fairly expensive BMP. Standing water may create mosquito habitat.</p> <p>MAINTENANCE REQUIREMENTS</p> <p>Retention design requires regular pumping and removal of stored stormwater. Inspections should be made on a monthly basis, especially after large storm events.</p> | <h3 style="text-align: center;">Impact</h3> <ul style="list-style-type: none"> ✓ Significant ✓ Medium Low Unknown or Questionable | |
| | | <div style="border: 1px solid black; padding: 10px; font-size: 2em; font-weight: bold; width: 100px; margin: 0 auto;">BGS</div> |

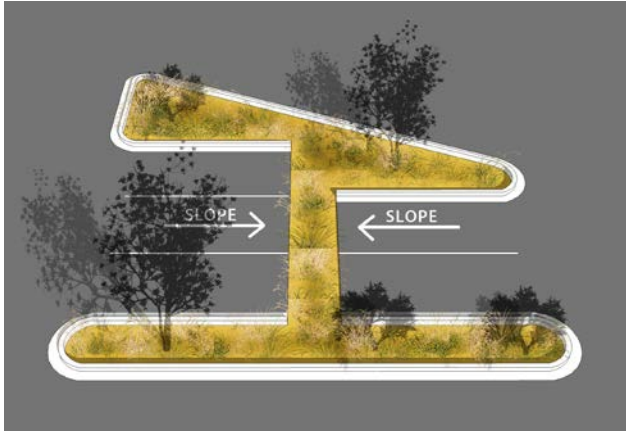

(This page intentionally blank)

| | |
|---|---|
| <h2 style="text-align: center;">Green Parking</h2> | <p style="text-align: center;">Applications</p> <ul style="list-style-type: none"> Perimeter Control Slope Protection ✓ Sediment Trapping Channel Protection ✓ Temporary Stabilization ✓ Permanent Stabilization Waste Management Housekeeping Practices |
|  | <p style="text-align: center;">Targeted Constituents</p> <ul style="list-style-type: none"> ✓ Sediment ✓ Nutrients Toxic Materials ✓ Oil and Grease Floatable Materials Construction Wastes |
| <p>DESCRIPTION</p> <p>Green Parking refers to several techniques that applied together reduce the contribution of parking lots to total impervious cover. From a stormwater perspective, green parking techniques applied in the right combination can dramatically reduce impervious cover and, consequently, reduce the amount of stormwater runoff. Green parking lot techniques include: setting maximums for the number of parking lots created; minimizing the dimensions of parking lot spaces; utilizing alternative pavers in overflow parking areas; using bioretention areas to treat stormwater; encouraging shared parking; and providing economic incentives for structured parking.</p> <p>PRIMARY USE</p> <p>Green Parking is primarily utilized in commercial development where large impermeable parking lots are required.</p> <p>APPLICATIONS</p> <p>All of the green parking techniques can be applied in new developments, and some can be applied in redevelopment projects.</p> <p>LIMITATIONS</p> <p>Limitations to green parking techniques include applicability, cost, and maintenance. Alternative pavers can have expensive maintenance costs.</p> <p>MAINTENANCE REQUIREMENTS</p> <p>Dependant on type of green parking utilized, regular inspection and maintenance may be required.</p> | <p style="text-align: center;">Impact</p> <ul style="list-style-type: none"> ✓ Significant ✓ Medium Low Unknown or Questionable |
| | <div style="border: 1px solid black; width: 100px; height: 100px; display: flex; align-items: center; justify-content: center; margin: 0 auto;"> GP </div> |

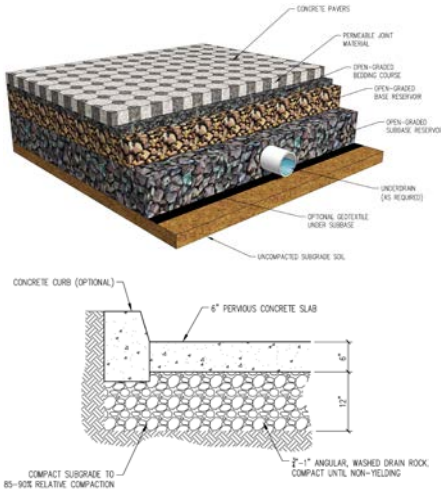
(This page intentionally blank)

| | |
|--|--|
| <h2 style="text-align: center;">Alternative Pavers</h2>  | <h3 style="text-align: center;">Applications</h3> <ul style="list-style-type: none"> Perimeter Control Slope Protection ✓ Sediment Trapping Channel Protection ✓ Temporary Stabilization ✓ Permanent Stabilization Waste Management Housekeeping Practices |
| <h3>DESCRIPTION</h3> <p>Alternative Pavers or permeable pavement refers to any one of several types of pavements and surface hardening that allows infiltration of stormwater below the pavement surface.</p> | <h3 style="text-align: center;">Targeted Constituents</h3> <ul style="list-style-type: none"> ✓ Sediment ✓ Nutrients Toxic Materials ✓ Oil and Grease Floatable Materials Construction Wastes |
| <h3>PRIMARY USE</h3> <p>Alternative Pavers provide an alternative to standard impermeable pavements in traffic and pedestrian areas. They can be utilized to improve flood control, to reduce nuisance drainage, and can improve adjacent vegetation by infiltrating stormwater to root systems.</p> | <h3 style="text-align: center;">Impact</h3> <ul style="list-style-type: none"> Significant ✓ Medium Low Unknown or Questionable |
| <h3>APPLICATIONS</h3> <p>Alternative pavers are suitable for urban settings with pedestrian traffic or lower volume vehicular traffic. As they are subject to clogging, pretreatment is required where offsite flows with high sediment loading may enter paved area. Best with urbanized areas.</p> <h3>LIMITATIONS</h3> <p>May be impacted by groundwater. Careful design required to maintain structural integrity if surface.</p> <h3>MAINTENANCE REQUIREMENTS</h3> <p>Inspections should be made on a monthly basis, especially after large storm events. If alternative pavement becomes clogged, surface may need to be cleaned of sediment.</p> | <div style="border: 1px solid black; width: 100px; height: 100px; margin: 0 auto; display: flex; align-items: center; justify-content: center;"> AP </div> |

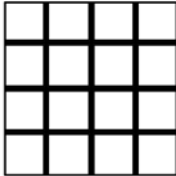
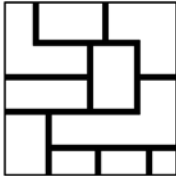
(This page intentionally blank)

| <h2 style="text-align: center;">Street Design and Patterns</h2> | | <h3 style="text-align: center;">Applications</h3> |
|--|---|---|
| <div style="display: flex; justify-content: space-around;"> <div style="text-align: center;"> <p>GRIDIRON</p>  <p>20,000</p> </div> <div style="text-align: center;"> <p>FRAGMENTED PARALLEL</p>  <p>19,000</p> </div> <div style="text-align: center;"> <p>WARPED PARALLEL</p>  <p>16,000</p> </div> <div style="text-align: center;"> <p>LOOPS AND LOLLIPOPS</p>  <p>15,300</p> </div> </div> <p style="text-align: center;"><u>APPROXIMATE LINEAL FEET OF PAVEMENT</u></p> | <ul style="list-style-type: none"> Perimeter Control Slope Protection ✓ Sediment Trapping Channel Protection ✓ Temporary Stabilization ✓ Permanent Stabilization Waste Management Housekeeping Practices | |
| <p>DESCRIPTION</p> <p>Street Design affords many instances where imperviousness can be reduced. Possibilities include reducing overall paved width, street siting, street patterns and overall street networks. (Source: Prince George's County)</p> <p>PRIMARY USE</p> <p>Street Design and Patterns is a planning BMP utilized to decrease amount of paved surfaces.</p> <p>APPLICATIONS</p> <p>Can be applied at planning level and design level of development. Applies to residential, commercial, and regional concepts.</p> <p>LIMITATIONS</p> <p>Local Ordinances may not allow reduced street widths. Future growth must be considered in design.</p> <p>MAINTENANCE REQUIREMENTS</p> <p>Regular road maintenance programs apply.</p> | <h3 style="text-align: center;">Targeted Constituents</h3> <ul style="list-style-type: none"> ✓ Sediment ✓ Nutrients Toxic Materials ✓ Oil and Grease Floatable Materials Construction Wastes | |
| | <h3 style="text-align: center;">Impact</h3> <ul style="list-style-type: none"> ✓ Significant ✓ Medium Low Unknown or Questionable <div style="text-align: center; border: 1px solid black; width: 100px; height: 100px; margin: 20px auto; display: flex; align-items: center; justify-content: center;"> SD </div> | |

(This page intentionally blank)

| | |
|---|---|
| <p>Urban Forestry</p>  | <p>Applications</p> <ul style="list-style-type: none"> Perimeter Control Slope Protection ✓ Sediment Trapping Channel Protection ✓ Temporary Stabilization ✓ Permanent Stabilization Waste Management Housekeeping Practices |
| <p>DESCRIPTION</p> <p>Urban Forestry is the study of trees and forests located in and around towns and cities. This BMP can include post-development planting of trees, bushes and shrubs, as well as design and construction phase preservation of pre-existing trees and vegetation. Since trees absorb water, patches of forest and the trees that line streets can help provide some of the stormwater management required in an urban setting. Urban forests help break up a landscape of impervious cover, provide small but essential green spaces, and link walkways and trails.</p> | <p>Targeted Constituents</p> <ul style="list-style-type: none"> ✓ Sediment Nutrients Toxic Materials Oil and Grease Floatable Materials Construction Wastes |
| <p>PRIMARY USE</p> <p>Urban Forestry is primarily used to provide natural buffers and reduce the quantity of stormwater runoff. Urban Forestry can also help to improve the quality of overall storm water runoff.</p> <p>APPLICATIONS</p> <p>Urban Forestry has the greatest impact when planted in a continuous dense footprint. Related benefits to urban Forestry include noise absorption, shade, privacy screening, moderation of local temperatures, and provision of a wind barrier.</p> | <p>Impact</p> <ul style="list-style-type: none"> ✓ Significant ✓ Medium Low Unknown or Questionable |
| <p>LIMITATIONS</p> <p>Plant species must be carefully considered related to watering, root systems, and nearby infrastructure.</p> <p>Irrigation requirements.</p> <p>New urban Forests will require extensive time to mature.</p> <p>Heavy foot traffic can compact forest floor and erode ground cover.</p> <p>MAINTENANCE REQUIREMENTS</p> <p>Initial maintenance may require regular watering and weeding.</p> | <p style="text-align: center; font-size: 2em; border: 1px solid black; padding: 10px; width: fit-content; margin: auto;">UF</p> |

(This page intentionally blank)