



Tim Keller, Mayor

May 22, 2022

To: Albuquerque Development Commission

From: Ciaran Lithgow, Redevelopment Project Manager

Subject: Case #2022-14 - Villa Agave Development Agreement

MRA staff have negotiated a mutually-agreeable Development Agreement with Villa Agave, LLC (“Developer”). The project, located in Downtown on the corner of 7th & Copper, will convert a former convent nursing facility into a multifamily project offering at least 14 housing units. MRA will provide \$400,000 to support the project, in addition to a Redevelopment Tax Abatement (see Case 2022-15 for a separate staff report).

In September 2021, MRA released the Downtown Housing RFP (RFP 01-2021) soliciting proposals for housing projects in the Downtown and Railroad MRAs. Developers were invited to propose projects that required gap funding in the face of rapidly escalating construction costs, caused by downstream effects of COVID-19. Total funding available from MRA was \$2.2M. MRA received two responses to the RFP, and was able to fund both projects without necessitating a Selection Committee.

The full Development Agreement is included herein. See the following pages for renderings, site plan, and landscape plan. The general terms of the project include:

- Developer responsibilities:
 - Rehabilitation of the abandoned property into at least 14 housing units
 - Removal of existing spray irrigation on the Property and installation of drip irrigation and xeriscape landscaping (climate-ready trees, grasses, and ornamental vegetation)
 - Installation of permeable pavement materials in the parking lot
 - Installation of climate-ready street landscaping in median
- Timeline:
 - Project will commence by September 30, 2022
 - Project will be complete by July 31, 2023

Findings:

- The MRA issued a Request for Proposals #01-2021 on September 23, 2021, soliciting proposals for housing projects in the Downtown and Railroad Metropolitan Redevelopment Areas.



- MRA received two responses to RFP #01-2022, both of which were able to be funded without necessitating a Selection Committee.
- A mutually-agreed Development Agreement was negotiated between the parties to meet the Downtown 2025 Metropolitan Redevelopment Plan by:
 - Expanding urban housing towards the goal of reaching 20,000 people living in the Downtown core by 2025; and,
 - Contributing to a walkable and vibrant Downtown district.

Recommended Motion: Based on the findings in the staff report, the ADC recommends to City Council approval, in form, of the Development Agreement with Villa Agave, LLC, for the development of the Villa Agave housing project.



LOCATION MAP

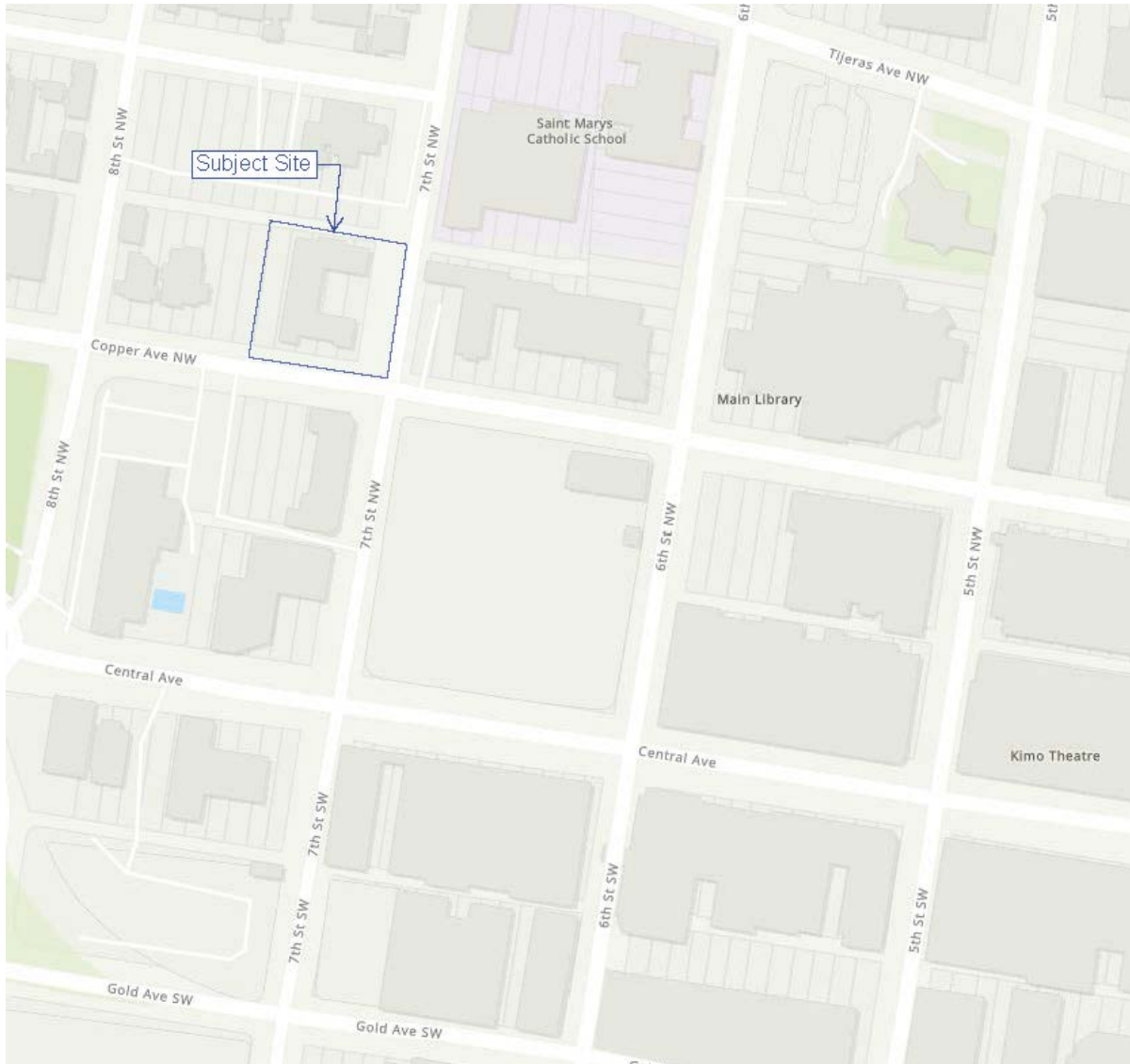



CONCEPTUAL RENDERINGS



Rendering of The Villa Agave



View from the Corner of Copper and 7th



View from 7th Street



North View along Copper Avenue



Resident Entrance at Proposed Parking



SITE PLAN

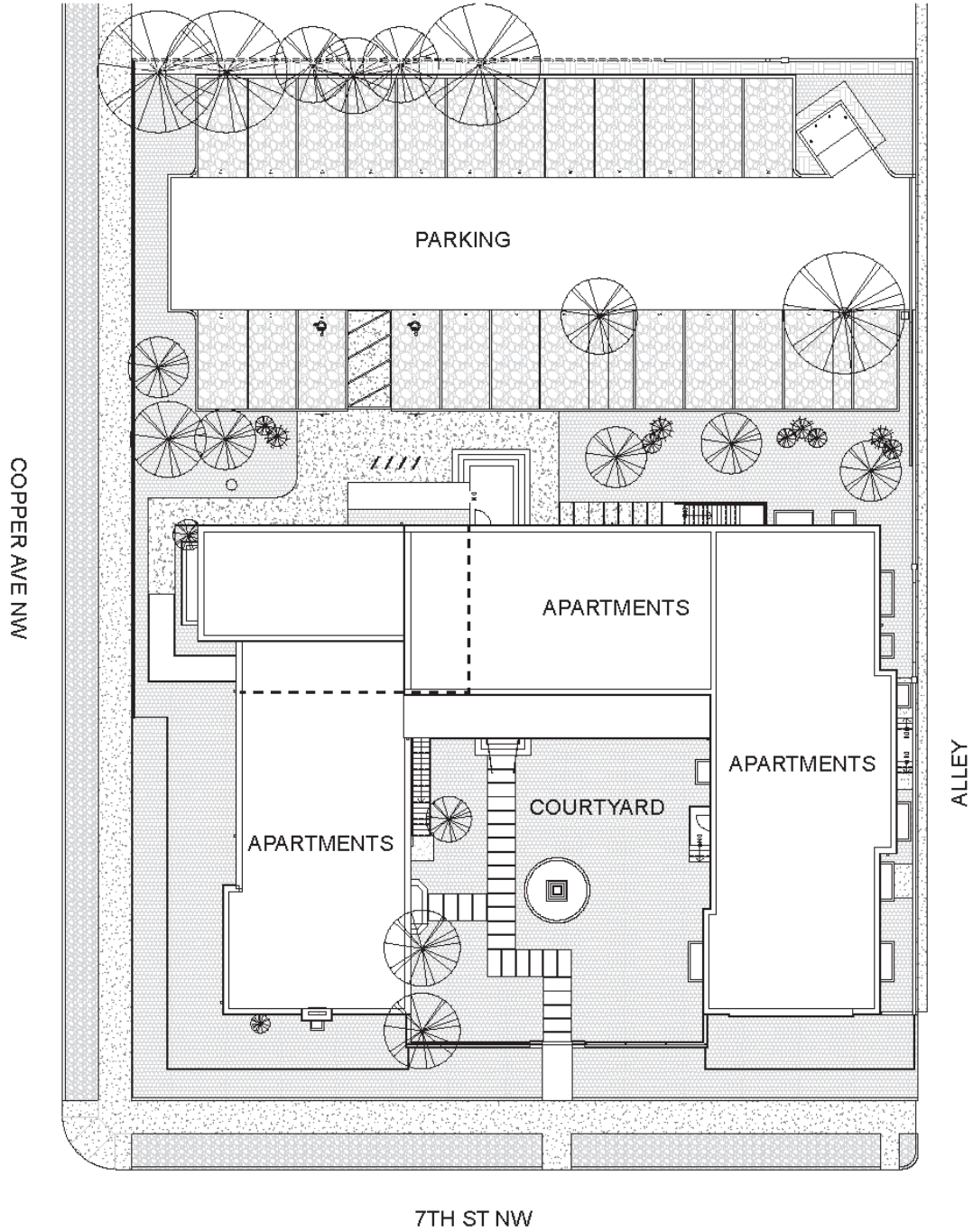



LANDSCAPE PLAN

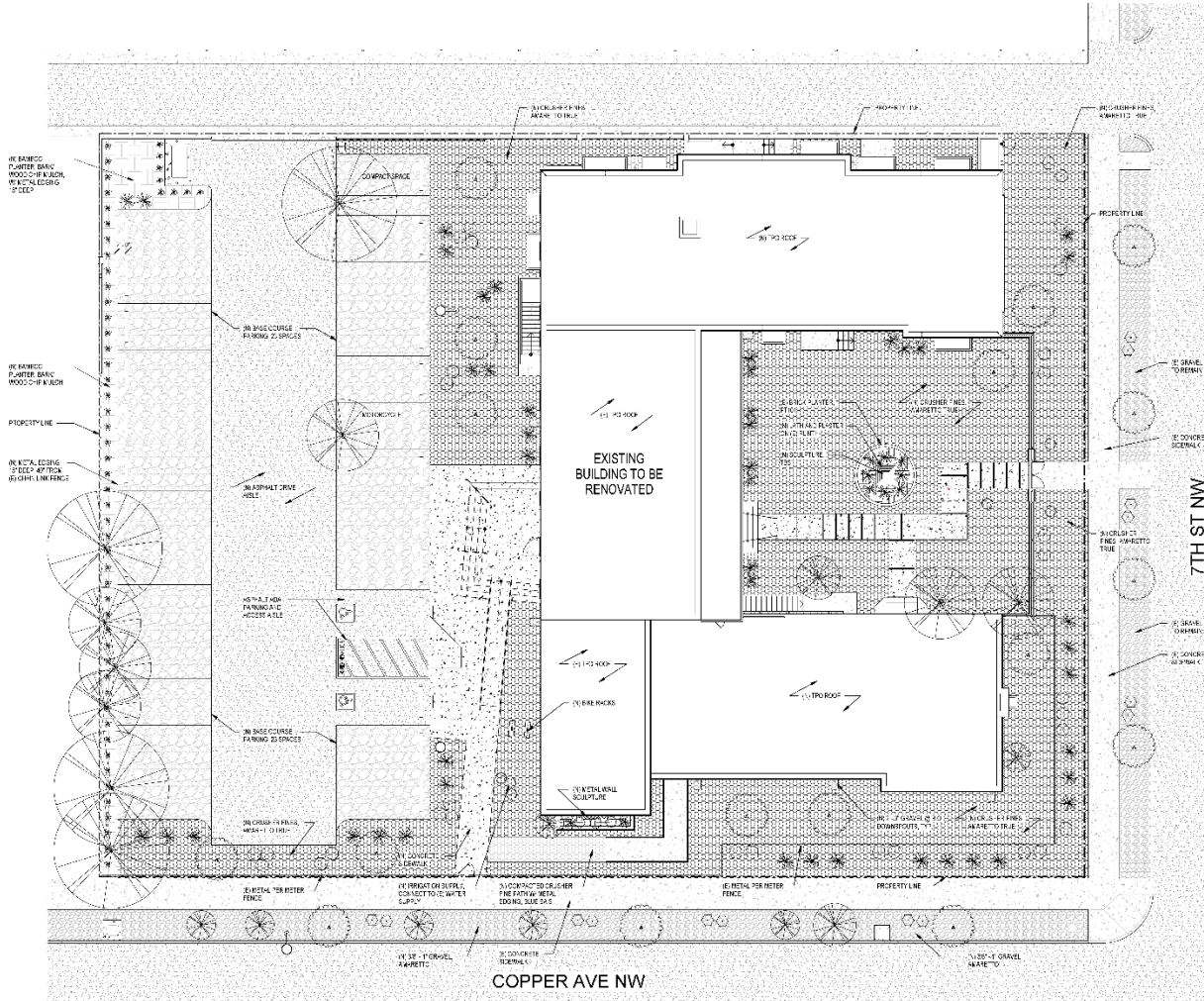

WALL AND FENCE

MINIMUM WALL HEIGHT TABLE (FSD/1)

ZONE CATEGORY	MINIMUM WALL HEIGHT
RESIDENTIAL	6 FEET
COMMERCIAL	8 FEET
INDUSTRIAL	10 FEET

EXCEPTIONS TO MINIMUM WALL HEIGHT TABLE
 1. WALLS FOR SIGNAGE OR ADVERTISING SHALL BE 10 FEET HIGH.
 2. WALLS FOR SIGNAGE OR ADVERTISING SHALL BE 12 FEET HIGH.
 3. WALLS FOR SIGNAGE OR ADVERTISING SHALL BE 15 FEET HIGH.

HATCH LEGEND

- 3/8\"/>

PLANTING LEGEND

TREES

- EXISTING TREE TO REMAIN - SEE VARIOUS
- DESERT PALM, 2\"/>

SHRUBS

- GRASSY BUSHES TO BE SELECTED
- CRUICKSHANK PRICKLY PEAR
- YUCCA BACATA, YUCCA, YUCCA, S. PALM

GRASSES

- HELMET WHEAT OR BIRCH GRASSES 7\"/>

A1 LANDSCAPE PLAN
 SCALE: 1" = 10'-0"

DEVELOPMENT AGREEMENT

By and between the
**Metropolitan Redevelopment Agency,
City of Albuquerque, Albuquerque, New Mexico,
a Municipal Corporation,**

and

**The Villa Agave LLC
a Single Member Limited Liability Corporation,
505 Central Ave NW, Suite E
Albuquerque, NM 87102**

VILLA AGAVE DEVELOPMENT

DEVELOPMENT AGREEMENT

THIS AGREEMENT is entered into and made effective on the date of the City's Chief Administrative Officer's signature below, by and between the Metropolitan Redevelopment Agency ("MRA"), a division of the **City of Albuquerque**, Albuquerque, New Mexico, a municipal corporation (hereinafter "City"), and **The Villa Agave LLC**, 505 Central Ave NW, Suite E, Albuquerque, NM 87102 (hereinafter "Developer"). The Developer is a New Mexico limited liability corporation, duly organized and validly existing as such under the laws of the State of New Mexico. City and Developer are sometimes hereinafter referred to collectively as "the Parties" and individually as "a Party."

RECITALS

WHEREAS, the New Mexico Metropolitan Redevelopment Code, Section 3-60A-1 et seq. NMSA 1978 (the "MR Code"), confers certain powers upon the municipality to promote catalytic developments within areas that have been deemed slum or blighted by the governing body of the municipality and authorizes the municipality to create a Metropolitan Redevelopment Agency; and

WHEREAS, the City of Albuquerque adopted Ordinance § 14-8-4 establishing the MRA for the City and known as the Metropolitan Redevelopment Agency Ordinance; and

WHEREAS, the MR Code requires that areas deemed slum or blighted must have a Metropolitan Redevelopment plan adopted by the municipality that provides proposed activities that will aid in the elimination or prevention of slum or blight; and

WHEREAS, the City Council, has made such a determination and designated the affected areas as the West Central Metropolitan Redevelopment Area ("MR Area") on May 19, 2001 by Enactment 82-2001; and

WHEREAS, the City Council adopted the Downtown 2025 Metropolitan Redevelopment Area Plan ("MR Plan") on May 11, 2004, by Enactment No. R-2004-044; and

WHEREAS, the MR Plan identifies the need for development that aids in the elimination and prevention of slum and blight and enumerates the following goals: 1) create a walkable and vibrant Downtown district, 2) ensure quality development, 3) create healthy neighborhoods, 4) expand urban housing with a goal of reaching 20,000 people living in the Downtown core, 5) encourage retail expansion, 6) improve and expand employment activity, 7) create a 24-hour destination for arts, culture, and entertainment, and 8) make Downtown a premier tourist destination; and

WHEREAS, the MRA released a Request for Proposals ("RFP") on September 23, 2021, soliciting redevelopment proposals for Downtown housing projects within the two MR Areas identified in the RFP;

WHEREAS, Developer submitted a response (the "Project Proposal") to the RFP that met the goals of Downtown 2025 Metropolitan Redevelopment Area Plan; and

WHEREAS, MRA received two responses to the proposal and was able to fund both projects without necessitating a Selection Committee;

WHEREAS, funding was appropriated to MRA in R-22-21 which was approved by City Council on [TO BE INSERTED];

WHEREAS, the power to issue a loan or grant is reserved for the City Council, and City Council approved this Agreement in form on [TO BE INSERTED]; and

WHEREAS, per Metropolitan Redevelopment Code (Chapter 3, Article 60A NMSA 1978), the use of these funds is for a public purpose, and the individual benefit accruing to persons as the result are incidental and outweighed by the benefit to the public as a whole and do not result in a donation or aid to any person, association, or public or private organization;

WHEREAS, subject to the language of **Section 11.21, Force Majeure**, time is of the essence, and implementation of this Agreement within the timeframe stated is of extreme importance to the City, and the City does not anticipate providing extensions except as specifically contemplated in this Agreement;

NOW THEREFORE, and in consideration of the premises and the mutual covenants hereinafter, set forth, the Parties formally covenant and agree as follows:

ARTICLE I Definitions

Section 1.1 The definitions in the MR Code, if any, as they exist at the time of the execution of this Agreement or as amended during the Term of this Agreement are adopted by reference and incorporated herein as though set forth in full in this paragraph. However, in the event of a conflict between one or more definitions in the MR Code and this Agreement, the definitions set forth in this Agreement shall prevail.

Section 1.2 Capitalized terms shall have the meaning assigned to them in this Agreement. If not otherwise defined in this Agreement or the MR Code, capitalized terms shall retain their customary meaning.

Section 1.3 Unless expressly set forth to the contrary in this Agreement, the terms used herein will have the following meanings:

- A. “Land” or “Property” means that certain real property situated in the City of Albuquerque, County of Bernalillo, State of New Mexico, described as follows:

705 Copper Ave NW, Albuquerque NM 87102, legal description 013 007N.M.T. ADD LOTS 13THRUL19 & E 1/2 L 20 as shown in **Exhibit A**.

ARTICLE II

Project Description, Site Plan, and Agreement Term

Section 2.1. Project Description. The redevelopment project Villa Agave (“Project”) consists of the following:

- A. Redevelopment of the former St. Mary’s Convent assisted living facility, which is a 12,146 square foot building with a 3,000 square foot basement, into a multi-family project with 15 housing units, or 14 housing units and one commercial space (“Building”) as shown in Exhibit B and described in the Project Proposal;
- B. Installation of at least one significant artistic feature such a mural (to be at least 150 square feet), or a large sculpture, to be located within prominent public view;
- C. Removal of existing spray irrigation on the Property and installation of drip irrigation, trees, grasses, and shrubbery (“Landscape Improvements”) as shown in Exhibit C;
- D. Installation of street trees, planting landscaping accents such as grasses and shrubs, gravel, and installation of drip irrigation in the median landscape verge (“Median Streetscape Improvements”) as shown in Exhibit C; and,
- E. Installation of permeable pavements and materials in the parking lot as described in Exhibit C.

Section 2.2 Plans, Specifications and Elevations for the Project. Intentionally Left Blank.

Section 2.3 Term of Agreement. This Agreement will become effective upon the execution hereof by the Chief Administrative Officer of the City of Albuquerque, or his or her designee (the "Effective Date"). The Term of this Agreement will commence upon the Effective Date and will terminate when City provides the written Acknowledgment of Satisfaction (as defined and described in Section 3.6). The period of time from the Effective Date to the date on which the City issues the Acknowledgment of Satisfaction shall constitute the “Term.”

ARTICLE III

Developer’s Responsibilities and Completion of the Project

Section 3.1. General Developer Responsibilities. Developer shall construct, maintain and operate the Project on the Property in material conformance with the plans and renderings described in the Project Proposal including any and all supplements, amendments and additions or deletions thereon or therein, as approved by the City. Developer and its affiliates, agents,

contractors, or subcontractors are solely responsible for the construction and management of the Project including, but not limited to:

- A. Assembling a Project team with the necessary expertise, experience, and capacity to develop and manage the Project.
- B. Attending and/or facilitating public forums, hearings, and briefings with relevant stakeholders, adjacent neighborhood associations, City Council, elected officials, City agencies, and other organizations as required to obtain the final permits for the Project;
- C. Securing all financing for all costs to complete the Project including but not limited to horizontal and vertical development cost, acquisition costs, pre-development costs, soft costs, off-site costs, and infrastructure costs;
- D. Obtaining and complying with all necessary governmental permits and any other approvals of any nature required for the development and construction of the Project;
- E. Designing and constructing all off-site and on-site improvements identified in this Agreement, including vertical construction and renovation of buildings, streetscapes, parks, utilities, roads, landscaping, building shells, tenant improvements, and installing fixture, finishes, and equipment;
- F. Maintaining and operating the Project, including, but not limited to management, maintenance, security, and other industry-standard activities in a first-class manner consistent with reputable standards and practices typical of similar projects within the Albuquerque metropolitan area; and
- G. Paying all applicable real estate taxes and other taxes associated with the Project.

Section 3.2. Other Developer Responsibilities. The Developer agrees to host a groundbreaking ceremony at Commencement and a ribbon cutting at Project Completion (both as defined herein) in partnership with the City of Albuquerque. The Developer shall work with MRA to schedule these in a manner and at a time that works for both the City of Albuquerque and the Developer.

Section 3.3. Commencement of Construction. The Commencement date for the construction shall be that point in time at which the Developer a) has acquired the Property, b) has secured all financing necessary to complete the Project, c) has obtained all required building permits, and d) has provided proof to MRA that a Performance Bond has been issued pursuant to Section 8.5 (“Commencement”). Commencement shall in no event occur later than July 30, 2022. Failure to meet these deadlines is a Material Event of Default as defined in this Agreement.

Section 3.4. Completion Date.

- A. The Developer shall complete the construction of the Project no later than September 30, 2023 (“Completion Date”). Failure to complete the construction by the Completion Date is a Material Event of Default of this Agreement.
- B. Completion shall be evidenced to the City by (i) Certificate(s) of Occupancy issued by the City for all buildings shown in the Proposal; and (ii) documentation of release of liens by contractors, subcontractors, and suppliers employed in the Project. Such documents shall be delivered to the City promptly but not later than sixty (60) days after the Completion Date (“Project Completion”).

ARTICLE IV
Public Funds Committed to the Project

Section 4.1 Description of Funding. City shall provide a grant to Developer in an amount not to exceed Four Hundred Thousand Dollars and No Cents (\$400,000.00) (“Grant Funds”) of Metropolitan Redevelopment Agency Funds.

Section 4.2 Disbursement of Grant Funds.

- A. City of Albuquerque shall disperse Funds to the Developer in the following order:
 - a. 25% of Grant Funds upon Commencement of the Project (as defined in Section 3.3);
 - b. 50% of Grant Funds at 50% of construction completion, which is defined to mean that wood framing is complete, and mechanical, electrical, and plumbing rough-in are complete;
 - c. 15% of Grant Funds at 90% of construction completion, which is defined to mean that:
 - c.i. Interior components are complete except for installation of fixtures, appliances, and flooring; and
 - c.ii. Exterior site work is complete (irrigation, paving, hardscaping, and fencing have been installed), but vegetation has not yet been planted; and
 - d. Final 10% of Grant Funds at Project Completion (as defined in Section 3.4(B)).

ARTICLE V
Reporting and Acknowledgment of Satisfaction

Section 5.1. Quarterly Reports.

- A. The Developer shall report, in writing to MRA, at least quarterly until Project Completion. Reports are due January 31, April 30, July 31, and October 31 for each preceding quarter for which the report is due.

B. Quarterly reports shall include an update on progress obtaining all necessary entitlements, permits, and approvals prior to construction. During construction, the reports will address construction progress (expressed as a percentage of Project Completion), and any concerns or perceived delays to complete the Project by the Project Completion Date. MRA shall provide a template for Quarterly Reports.

Section 5.2. Acknowledgment of Satisfaction. Following the Project Completion, the MRA shall provide a letter acknowledging satisfaction of the terms contained herein, which shall not impact or release the Developer from any other agreements the City or MRA may have with the Developer.

ARTICLE VI Warranties and Obligations

Section 6.1. Warranties and Obligations by the City. The City makes the following warranties as the basis for the undertakings on its part contained herein: The MRA is a function of the City, a municipal corporation organized and existing under and pursuant to the laws of the State of New Mexico and which is authorized to provide financing for, acquire, construct, own, lease, rehabilitate, improve, sell and otherwise assist projects for the purpose of promoting catalytic developments within areas that have been deemed blighted by the municipality. Except as otherwise set forth in this Agreement, City makes no other warranties, express or implied.

Section 6.2. Warranties and Obligations by Developer. Developer makes the following warranties as the basis for the undertakings on its part herein contained.

A. The Developer is a New Mexico Limited Liability Corporation, duly organized and validly existing as such under the laws of the State of New Mexico, and registered to conduct business in the State of New Mexico. The Developer has the requisite corporate authority and power to enter into this Agreement and to perform its obligations hereunder, and it has duly authorized the execution and delivery of this Agreement by the signatory executing this Agreement on its behalf.

B. The execution and delivery of this Agreement, the consummation of the transactions contemplated hereby, and Developer's compliance with the terms and conditions of this Agreement will not violate the terms of the Developer's Articles of Organization or Operating Agreement or conflict with or result in a breach of any of the terms, conditions, or provisions of any corporate restriction or any agreement or any instrument to which Developer is a party or by which it is bound, nor will it result in the creation or imposition of any prohibited lien, charge, or encumbrance of any nature whatsoever upon the Property or the Project, except for any permitted encumbrances.

C. There are no legal or administrative proceedings pending or, to Developer's knowledge, threatened against Developer or affecting the Project which, if determined adversely, would have a material adverse effect on Developer or the Project or on the

ability of Developer to perform its obligations under this Agreement and any related agreements.

D. At all times the Project shall comply in all material respects with all applicable zoning and planning ordinances, building codes, flood regulations, environmental laws, ordinances, statutes, rules, and regulations relating to the Project.

E. Developer shall not amend or change its Operating Agreement or Articles of Organization or otherwise amend its governing documents in any manner if such amendment or change would result in a conflict with the terms of this Agreement at any time during the Term of this Agreement.

F. No City Councilor, officer, or employee of the City has any direct, indirect, legal, or beneficial interest in the Developer, the Project, this Agreement or in any contract or agreement between the City and Developer or in any franchise, concession, right or privilege of any nature granted by the City to the Developer in this Agreement.

G. Developer covenants and warrants that the only person or firm interested in this Agreement as principal or principals is named in this Agreement, and that this Agreement is entered into by the Developer without collusion on the part of the Developer with any person or firm, without fraud and in good faith. The Developer also covenants and warrants that no gratuities, in the form of entertainment, gifts or otherwise, were, or during the Term of this Agreement, will be offered or given by the Developer or any agent or representative of the Developer to any officer or employee of the City with a view towards securing this Agreement or for securing more favorable treatment with respect to making any determinations with respect to performing this Agreement.

H. The Developer covenants and agrees that no funds awarded through this Agreement will be used for sectarian religious purposes, and specifically that:

- i) there will be no religious test for tenancy eligibility;
- ii) there will be no requirement for attendance at religious services;
- iii) there will be no inquiry as to religious preference or affiliation;
- iv) there will be no proselytizing; and
- v) services provided, if any, will be essentially secular.

ARTICLE VII

Real Property Taxes, Insurance, and Other Amounts Payable

Section 7.1. Payment, Fees, and Other Amounts Payable. Developer shall promptly pay or cause to be paid, as the same become due, real property taxes, utility, and other charges incurred in the operation, maintenance, use, occupancy, and upkeep of the Project, provided that with

respect to governmental charges that may lawfully be paid in installments over a period of years, Developer shall be obligated to pay only such installments as are required to be paid during the Term of this Agreement when due. Developer may, in good faith, contest any such charges and in the event of any such contest may permit the charges so contested to remain unpaid during the period of such a contest and any appeal therefrom, provided that during such period, enforcement of any such contested item shall be effectively stayed. If the City reasonably determines that the aforementioned amounts have not been paid, the City shall send a written notice of default, detailing the specific payment that it believes Developer has failed to complete, to the Developer who shall then have fifteen (15) business days to provide verification of payment or cure the default; provided, if such default cannot with due diligence be wholly cured within such fifteen (15) business day period, Developer shall have such longer period as may be reasonably necessary to cure the default, so long as Developer proceeds promptly to commence the cure of same within such fifteen (15) business day period and diligently prosecutes the cure to completion in which case, it shall not constitute a default. This contract in no way will prevent the Developer from participating in the Redevelopment Tax Abatement program.

Section 7.2. Payments Required. The obligations of Developer to make the payments required in Section 7.1 hereof and to perform and observe the other agreements on its part contained in this Agreement shall be absolute and unconditional without offset or counterclaim for claims against the City or any other party.

Section 7.3. Insurance Required. During the construction period, Developer shall keep the Project insured or cause the Project to be kept insured against loss or damage by maintaining policies of insurance and by paying, as the same become due and payable, all premiums with respect thereto, including but not necessarily limited to the following coverage:

A. **Comprehensive General Liability Insurance.** Developer shall obtain comprehensive general liability insurance, including automobile insurance, with liability limits in amounts not less than \$2,000,000 aggregate limit of liability for bodily injury, including death, and property damage in any one occurrence. Said policies of insurance must include coverage for all operations performed on or about the Project, including coverage for collapse, explosion and underground liability coverage, coverage for the use of all owned, non-owned, hired automobiles, vehicles and other equipment both on the Project site and contractual liability coverage which shall specifically insure the indemnification provisions of this Agreement. The above requirement shall include but shall not be limited to protection against damage or destruction of public and private property, including telephone conduit, telegraph conduit, power conduit, telephone signal cables, fiber optics cables, television cables, computer cables, fire alarm circuits, gas mains, water service connections, sanitary sewer, sewer, house or building connections, water mains, water service connections, steam lines, petroleum products pipelines, storm drains, storm inlet lines including all appurtenances thereto while located below the surface of the ground including injury or death to person or persons caused by Developer's operations including blasting and trenching, backfilling, tamping, with or without the use of mechanical equipment, and the collapse of or structural damage to a building, house or structure including power, telephone, telegraph, fire alarm, street light poles, curb, gutter and sidewalk on public or private property and destruction of or

damage to other public or private property resulting therefrom including injury or death to person or persons and all causes by Developer's operations in the removal of other building structures including their supports, trees and utility poles or by excavation including blasting and trenching, backfilling, tamping with or without use of mechanical equipment. Other public and private property as used above shall include but not be limited to lawns, plants, flowers, trees, fences, yards, walls.

B. Worker's Compensation Insurance. Developer shall comply with the provisions of the Worker's Compensation Act, the Subsequent Injury Act and the New Mexico Occupational Disease Disablement Law. Developer shall procure and maintain, or Developer shall require its general contractor to procure and maintain, complete Worker's and Employer's Liability Insurance in accordance with New Mexico law and regulations. Such insurance shall include coverage permitted under NMSA 1978, §52-1-10 for safety devices. With respect to worker's compensation insurance, if Developer or a general contractor elects to be self-insured, it shall comply with the applicable requirements of law. If any portion of the construction of the Project is to be subcontracted or sublet, Developer shall require the contractor and subcontractor to similarly provide such coverage (or qualify as self-insured) for all latter's employees to be engaged in such work. It is agreed with respect to all worker's compensation insurance, Developer and its surety shall waive any right of subrogation they may acquire against the City, its officers, agents and employees by reason of any payment made on account of injury, including death, resulting therefrom sustained by any employee of the insured arising out of performance of this Agreement. Neither the Developer nor its employees are considered to be employees of the City of Albuquerque for any purpose whatsoever. The Developer is considered to be an independent contractor at all times in the performance of this Agreement. The Developer further agrees that neither it nor its employees are entitled to any benefits from the City under the provisions of the Worker's Compensation Act of the State of New Mexico, nor to any of the benefits granted to employees of the City under the provisions of the Merit System Ordinance as now enacted or hereafter amended.

C. Builder's Risk Insurance. Developer shall procure, or Developer shall cause its general contractor to procure and maintain, until completion of the construction, builder's risk, vandalism and malicious mischief insurance. Alternatively, Developer shall procure and maintain insurance, or Developer shall cause its general contractor to procure and maintain, against loss or damage to the Project by fire, lightning, vandalism, and malicious mischief with the uniform extended coverage endorsement limited only as may be provided in the standard form or extended coverage endorsement at the time in use by the State of New Mexico to provide for not less than 90% recovery of the market value of the buildings and other improvements as constructed at the time of destruction.

D. Increased Limits. The City may require Developer to reasonably increase the maximum limits of any insurance required herein and Developer shall promptly comply.

E. Proof of Insurance. During construction, and not less than once each year, on or before July 31, Developer shall provide to the City without demand, or more frequently

upon demand, proof of all required insurance coverages.

Section 7.4 Application of Net Proceeds of Insurance. During the construction period, the net proceeds of builder's risk insurance, and of fire and other hazard and casualty insurance, carried pursuant to the provisions of this Agreement hereof, shall be applied as provided in this Agreement and the net proceeds of liability insurance carried pursuant to the provisions of this Agreement hereof shall be applied toward extinguishment or satisfaction of the liability with respect to which such insurance proceeds have been paid. The net proceeds of the bonds provided pursuant to this Agreement shall be applied to curing the defect in performance or payment.

Section 7.5 Additional Provisions Regarding Insurance. All insurance required to be taken out by Developer pursuant to this Agreement shall be taken out and maintained with generally recognized responsible insurance companies authorized to do business in the state of New Mexico selected by Developer. An original or duplicate copy of the insurance policies providing the coverage required herein shall be deposited with the City. Prior to expiration or exchange of such policy, Developer shall furnish evidence satisfactory to the City that the policy has been renewed or replaced or is no longer required by this Agreement upon demand. All policies required hereunder shall provide that the City shall be given thirty (30) days prior written notice of cancellation, non-renewal or material alteration of coverage. Provisions that the insurance company shall "endeavor to give the City notice" shall not be allowed.

Section 8.5. Performance Bond. Developer or its Contractor shall furnish or cause to be furnished either a performance bond or irrevocable letter of credit acceptable to the City ("Performance Bond"), as security for the faithful performance and payment of all its obligations pursuant to the construction of the Project. These bonds shall be in amounts equal to the amount of the Grant Funds and in such form and with such sureties as are licensed to conduct business in the State of New Mexico and are named in the current list of surety companies acceptable on federal bonds as published in the Federal Register by the Audit Staff of Accounts, U. S. Treasury Department. The performance bond shall also include coverage for any guaranty period provided by the Contractor. The surety on the performance bond shall furnish a waiver whereby it consents to the progress or partial payment to any Contractor of amounts for materials and acknowledges that such payment shall not preclude enforcement of such remedies as may be available against such surety by law or under this Agreement. Developer shall cause the City to be named as obligee on such bonds. If the surety on any bond furnished by Developer is declared bankrupt or becomes insolvent or its right to do business in the State of New Mexico is revoked, Developer shall substitute or cause to be substituted another bond and surety within thirty (30) days thereafter. The Developer may furnish an irrevocable letter or letters of credit in form satisfactory to the City as an alternative to the performance bond specified above. Any such letter must be drawn against a New Mexico institution whose deposits are federally insured and shall be payable exclusively to the City on demand.

ARTICLE VII

Damage, Destruction and Condemnation

Section 8.1. Damage, Destruction, and Condemnation. In the event the Project is destroyed or damaged, in whole or in part, by fire or other casualty, Developer shall have the right to use the net proceeds of insurance to restore the Project, and other improvements located on the Property to substantially the same conditions as existed prior to the casualty causing the damage or destruction. If the insurance proceeds derived from a claim for damage or destruction are not used to restore the Project, then the amount of Grant Funds dispersed to date of said proceeds shall be paid to the City by the Developer or Developer's assigns.

Section 8.2. Partial Damage, Destruction, and Condemnation. If the casualty or condemnation affects only part of the Project and total rebuilding is infeasible, then proceeds may be used for partial rebuilding and partial repayment of the Grant Funds, in a manner that provides adequate security to the City for repayment of the remaining balance of the Grant Funds. In the event City and Developer cannot agree on the approach to take, City shall make the final decision and Developer agrees to be bound by that decision.

ARTICLE IX

Special Covenants

Section 9.1 City's Right of Access to the Project. Developer agrees that the City and any of its duly authorized agents shall have the right at all reasonable times following 24-hours written notice and subject to the rights of the tenants and guests, to enter upon and examine and inspect the Project provided that any such inspections shall be conducted in a manner that will minimize any intrusion on the operations of the Project.

Section 9.2 Good Standing. Developer warrants and represents that it has executed, filed and recorded all certificates and other documents and has done and shall continue to do throughout the Term of this Agreement such other acts as may be necessary or appropriate to comply with all applicable requirements for the formation, qualification and operation of a limited liability corporation, and the operation and ownership of the Project under the laws of the State of New Mexico.

Section 9.3 Release and Indemnification Agreement.

A. Developer releases the City from, and covenants and agrees that the City shall not be liable to the Developer for any loss or damage to property or any injury to or death of any person or persons occasioned by any cause whatsoever pertaining to the Project, the Property, the use thereof, or any other transaction contemplated by this Agreement; provided that such release shall not apply to any loss or damage caused by the negligence or willful acts of the City or any City employees or agents.

B. Developer shall defend, indemnify, and hold harmless the City from any loss, claim, damage, act, penalty, liability, disbursement, litigation expense, attorneys' fees, or court costs arising out of or in any way relating to this Agreement, or any other cause whatsoever pertaining to the Project, provided that such indemnity shall not apply to any loss or damage caused by the negligence or willful acts of the City or any City employees or agents and further subject to the limitations of NMSA 1978 § 56-7-1. The City shall, after receipt of notice of the existence of a claim for which it is entitled to indemnity

hereunder, notify Developer in writing of the existence of such claim or commencement of such action. This indemnification agreement shall survive the termination of this Agreement.

Section. 9.4. Subordination, Sale, Assignment, Sublet, or Encumbrance of Project. Except as otherwise expressly permitted herein, Developer shall not sell, assign, dispose of, mortgage, or in any way encumber the Project or any part thereof without the prior written consent of the City prior to Project Completion. Upon the City's approval of the Developer's financing arrangements, the City may in its discretion subordinate the Grant Funds to one or more mortgages for borrowed funds necessary to develop the Project. The Developer shall not delegate, assign, sublet, or otherwise transfer, in whole or in part, any of the rights or responsibilities granted in or required under this Agreement without the prior written approval of the City. The City has no obligation to and shall not be required to approve any assignment or other transfer of this Agreement that would result in the services required in this Agreement being performed by any other person or entity other than the Developer.

Section 9.5 Authority of Authorized City Representative. Whenever under the provisions of this Agreement the approval of the City is required or Developer is required to take some action at the request of the City, such approval or such request shall be made by the Authorized City Representative (as defined in Section 11.1) unless otherwise specified in this Agreement and Developer shall be authorized to act on any such approval or request.

Section 9.6 Authority of Authorized Developer Representative. The Developer represents and warrants to the City that the Authorized Developer Representative (as defined in Section 11.1) is empowered to take all actions contemplated herein and that reliance by the City on the authority of the Authorized Developer Representative shall not give rise to a complaint against the City as a result of any action taken by the City.

Section 9.7 Financial Statement of Developer. During the Term of this Agreement, Developer agrees to furnish the City a copy of the Project's annual financial statements within ninety (90) days of the end of the Developer's fiscal year.

ARTICLE X

Events of Default Defined and Remedies Upon Default

Section 10.1. Events of Default Defined. The following shall be "Material Events of Default" under this Agreement, also referred to as "Events of Default" or "Default" shall mean, whenever they are used in this Agreement, any one or more of the following events:

- A. Failure by Developer to perform any of the provisions, covenants or conditions as outlined in Article III.
- B. Breach of the City of any warranty or obligations set forth in Sections 6.1.
- C. Breach of Developer of any warranty or obligations set forth in Section 6.2.

D. Failure to maintain insurance in the amount or manner required in Section 7.3

E. Failure to maintain a performance bond or irrevocable letter of credit in the amount and manner required in Section 8.5.

Section 10.2. No Remedy Exclusive. No remedy herein conferred upon or reserved to the City or the Developer nor any remedy conferred upon or reserved to the City or the Developer is intended to be exclusive of any other available remedy but each and every such remedy shall be cumulative and shall be in addition to every other remedy given under this Agreement or now or hereafter existing at law or in equity or by statute. No delay or omission to exercise any right or power accruing upon any default shall impair any such right or power or shall be construed to be a waiver thereof but any such right and power may be exercised from time to time and as often as may be deemed expedient. In order to entitle the City to exercise any remedy reserved to it in this Article, it shall not be necessary to give any notice other than such notice as may be herein expressly required.

Section 10.3. Agreement to Pay Attorneys' Fees and Expenses. If any legal action is brought by the City to enforce the cure of a Material Event of Default after the applicable notice and cure period and the City prevails in such action, City shall be entitled to recover its reasonable, actual, out-of-pocket attorney fees and expenses incurred in such action. If Developer Defaults under any of the provisions of this Agreement, and the City employs attorneys (whether in-house or outside counsel), or incurs other expenses for the enforcement of performance or observance or any obligations or agreement on the part of Developer herein contained in this Agreement, Developer shall pay to the City the reasonable fees of all such attorneys and such other reasonable expenses incurred by the City.

Section 10.4. No Additional Waiver Implied by One Waiver. If any provision contained in this Agreement should be breached by any Party and thereafter waived by the Party, such waiver shall be limited to the particular breach so waived and shall not be deemed to waive any other breach.

Section 10.5. Redemption Period. Intentionally deleted.

Section 10.6. Remedies Upon Default.

A. Upon any Material Event of Default and regardless of any other notices previously provided, the non-defaulting Party may send a "Notice of Material Default" to the defaulting Party describing the Material Event of Default and requiring cure within sixty (60) days from the date of the mailing of the Notice.

B. If the Material Event of Default is not cured or arrangements satisfactory to the non-defaulting Party made to cure the Material Event of Default, the non-defaulting Party may elect to sue for direct damages suffered by it due to the Material Event of Default. Except where otherwise stated, the City may, at the City's option and without limiting the City in the exercise of any other right or remedy the City may have

on account of such Default, pursue any remedy allowed by this Agreement, at law, or in equity. The City shall have the unrestricted right to call on the Performance Bond. The City shall have the right to place a lien on the Property, in whole or in part, and including all land and all buildings, and then to foreclose on said lien.

Section 11.6. Developer to Pursue Remedies Against Contractor and Subcontractors and their Sureties. In the event of a Material Event Default of any contractor or subcontractor under any contract made in connection with the Project, Developer shall promptly proceed either separately or in conjunction with others to exhaust any remedies against the contractor or subcontractor so in default and against each surety for the performance of such contractor or subcontractor. Developer may prosecute or defend any action or proceeding or take other action involving such contractor or subcontractor or surety or other guarantor or indemnitor which Developer deems reasonably necessary.

ARTICLE XI Miscellaneous

Section 11.1 Notices. All notices, certificates or other communications hereunder shall be sufficiently given and shall be deemed given when mailed by registered or certified mail, return receipt requested, postage prepaid, addressed as follows:

If to the City: Authorized City Representative
Manager, Metropolitan Redevelopment Agency
City of Albuquerque
PO Box 1293
Albuquerque, NM 87103

If to Developer: Authorized Developer Representative
Mark Baker, AIA
The Villa Agave LLC
505 Central Ave NW, Suite E
Albuquerque, NM 87102

The City and Developer may, by notice given hereunder, designate any further or different addresses to which subsequent notices, certificate or other communication shall be sent.

Section 11.2. Binding Effect. This Agreement shall inure to the benefit of and shall be binding upon the City and Developer, and their respective successors and assigns, subject however to the limitations contained herein.

Section 11.3. Severability. In the event any covenant, condition, or provision herein is held to be invalid, illegal, or unenforceable by any court of competent jurisdiction, such covenant, condition, or provision shall be deemed amended to conform to applicable laws so as to be valid or enforceable or, if it cannot be so amended without materially altering the intention of the

parties, it shall be stricken. If stricken, all other covenants, conditions and provisions of this Agreement shall remain in full force and effect provided that the striking of such covenants, conditions, or provisions does not materially prejudice either the City or the Developer in its respective rights and obligations contained in the valid covenants, conditions or provisions of this Agreement.

Section 11.4. Amendments, Changes and Modifications. Except as otherwise provided in this Agreement, this Agreement shall not be effectively amended, changed, modified, altered, or terminated except by mutual written agreement of the Parties. Metropolitan Redevelopment Agency Manager is authorized to enter into amendments to this Agreement which do not materially, adversely impact the City's rights or obligations pursuant to this Agreement.

Section 11.5. Intentionally deleted.

Section 11.6. Other Instruments. Developer and the City covenant that they shall do, execute, acknowledge and deliver or cause to be done, executed, acknowledged and delivered such instrument, supplemental hereto and further acts, instruments and transfers as may be required hereunder. All such ancillary agreements shall be in accordance with and not contradictory to the terms and conditions set forth in this Agreement.

Section 11.7. Governing Law. This Agreement shall be governed by and construed in accordance with the laws of the State of New Mexico.

Section 11.8. Recording. Recorded documents shall be recorded in the office of the County Clerk of Bernalillo County New Mexico by the Developer.

Section 11.9. No Pecuniary Liability of City. No provision of this Agreement shall constitute an indebtedness of the City within the meaning of any constitutional provision or statutory limitations of the State of New Mexico, nor constitute or give rise to a pecuniary liability of the City or a charge against its general credit or taxing powers.

Section 11.10. Officials, Agents and Employees Not Personally Liable. No official, agent or employee of the City nor member of the City Council shall be personally liable to any person by virtue of any provision of this Agreement.

Section 11.11. Waiver. No provisions of this Agreement shall be deemed to have been waived by either Party unless such waiver is in writing, signed by the Party making the waiver and addressed to the other Party, nor shall any custom or practice which may evolve between the parties in the administration of the terms of this Agreement be construed to waive or lessen the right of either party to insist upon the performance of the other party in strict accordance with the terms of this Agreement. Further, the waiver by any Party of a breach by the other party or any term, covenant, or condition hereof shall not operate as a waiver of any subsequent breach of the same or any other term, covenant, or condition thereof.

Section 11.12. Gender, Singular/Plural. Words of any gender used in this Agreement shall be held and construed to include any other gender, and words in the singular number shall be held to

include the plural, and vice versa, unless the context otherwise requires.

Section.11.13 Captions and Section Headings. The captions, section headings, and table of contents contained in this Agreement are for convenience of reference only, and in no way limit, define, or enlarge the terms, scope, and conditions of this Agreement.

Section 11.14. Relationship of Contract Documents. All documents attached to this Agreement or incorporated into this Agreement are complementary, and any requirement of one contract document shall be as binding as if required by all. Any inconsistency among the various documents shall be resolved in favor of the language in this Agreement which, along with its amendments, if any, is deemed to be the primary document.

Section 11.15. Exhibits, Certificates, Documents Incorporated and Attachments. All certificates, documents, exhibits, attachments, riders, and addenda referred to in this Agreement are hereby incorporated into this Agreement by reference and made a part hereof as though set forth in full in this Agreement to the extent they are consistent with its conditions and terms.

Section 11.16. Governmental Rights and Powers. Nothing in this Agreement shall be construed or interpreted as limiting, relinquishing, waiving, or defining governmental rights and the police powers of the City or abrogating the requirement of any ordinance.

Section 11.17. Cross References. References in the text of this Agreement to articles, sections, or exhibits pertain to articles, sections or exhibits of this Agreement unless otherwise specified.

Section 11.18. Time is of the Essence. Subject to the qualifications otherwise set forth herein, time is of the essence in the performance of this Agreement.

Section 11.19. Intentionally deleted.

Section 11.20. No Partnership or Agency. Nothing contained in this Agreement is intended or shall be construed in any respect to create or establish any relationship other than that of the owner and contractor, and nothing herein shall be construed to establish any partnership, joint venture or association or to make Developer the general representative or agent of City for any purpose whatsoever.

Section 11.21. Force Majeure. Except as expressly provided in this Agreement, neither City, nor Developer shall be deemed to be in default hereunder if either party is prevented from performing any of the obligations, other than payment of rental, fees and charges hereunder, by reason of strikes, boycotts, labor disputes, embargoes, shortages of energy or materials, acts of the public enemy, infectious disease or pandemic, weather conditions, and the results of acts of nature, riots, rebellion, sabotage, or any other similar circumstances for which it is not responsible or which are not within its control. After the termination of any such event of Force Majeure, the obligation to perform shall recommence with an appropriate and reasonable extension to any deadlines. The Parties stipulate that Force Majeure shall not include the novel coronavirus Covid-19 pandemic which is ongoing as of the date of the execution of this Agreement. For the avoidance of doubt, Force Majeure shall not include: (a) financial distress

nor the inability of either party to make a profit or avoid a financial loss, (b) changes in the market prices or conditions, or (c) a party's financial inability to perform its obligations hereunder.

Section 11.22. Forum Selection. Any cause of action, claim, suit, demand, or other case or controversy arising from or related to this Agreement shall only be brought in and pursued to completion at the Second Judicial District Court located in Bernalillo County, New Mexico or in the federal district court located in Albuquerque, New Mexico. The Parties irrevocably admit themselves to, and consent to, the jurisdiction of either of said court. The provisions of this section shall survive the termination of this Agreement.

Section 11.23. Compliance with Laws. The Developer shall comply with all applicable laws, ordinances, regulations, and procedures of Federal, State, and local governments in the development, construction, maintenance, and management of the Project

Section 11.24. No Reliance; Construction. City and Developer acknowledge and agree that they have thoroughly read this Agreement, including all exhibits thereto, and have sought and received whatever competent advice and counsel was necessary for them to form a full and complete understanding of all rights and obligations herein. City and Developer further acknowledge that the Agreement is the result of negotiations between them and this Agreement shall not be construed against either Party by reason of that Party's preparation of all or part of this Agreement.

Section 11.25. Appropriations. Notwithstanding any other provisions in this Agreement, the terms of this Agreement are contingent upon the City Council of the City of Albuquerque making the appropriations necessary for the performance of this Agreement. If sufficient appropriations and authorizations are not made by the City Council, or if the City Council unappropriates and deauthorizes funds during a fiscal year, this Agreement may be terminated upon thirty (30) days' written notice given by the City to all other parties to this Agreement. Such event shall not constitute an event of default. All payment obligations of the City and all of its interest in this Agreement will cease upon the date of termination. The City's decision as to whether sufficient appropriations are available shall be accepted by all parties and shall be final.

Section 11.26. Liability. Any liability incurred in connection with this Agreement is subject to the immunities and limitations of the New Mexico Tort Claims Act, Section 41-4-1 et seq., NMSA 1978, as amended.

Section 12.27. Discrimination Prohibited. In performing the services required hereunder, the parties hereto shall not discriminate against any person on the basis of race, color, religion, gender, sexual preference, sexual orientation, national origin or ancestry, age, physical handicap, or disability as defined in the Americans With Disabilities Act of 1990, as now enacted or hereafter amended.

Section 11.28. ADA Compliance. In performing the services required hereunder, Developer will ensure any contractors agree to meet all the requirements of the Americans With Disabilities Act of 1990, and all applicable rules and regulations (ADA), which are imposed directly on the

Contractor or which would be imposed on the City as a public entity. Developer, through any contractor, agrees to be responsible for knowing all applicable requirements of the ADA and to defend, indemnify and hold harmless the City, its officials, agents and employees from and against any and all claims, actions, suits or proceedings of any kind brought against said parties as a result of any acts or omissions of the Contractor or its agents in violation of the ADA.

Section 11.29. Audits and Inspections. At any time during normal business hours and as often as the City may deem necessary, there shall be made available to the City for examination all of the Developer's records with respect to all matters covered by this Agreement. The City shall give reasonable notice to the Developer of such examination, and in any event, a minimum of 2 business days prior notice. The Developer shall permit the City to audit, examine, and make excerpts or transcripts from such records, and to make audits of all contracts, invoices, materials, payrolls, records of personnel, conditions of employment and other data relating to all matters covered by this Agreement. The Developer understands and will comply with the City's Accountability in Government Ordinance, §2-10-1 et seq. and Inspector General Ordinance, §2-17-1 et seq. R.O.A. 1994, and also agrees to provide requested information and records and appear as a witness in hearings for the City's Board of Ethics and Campaign Practices pursuant to Article XII, Section 8 of the Albuquerque City Charter.

Section 11.30. Representation. Each Party hereto acknowledges that it has been represented, or has had ample opportunity to obtain representation of counsel, with respect to this Agreement. Accordingly, each Party hereto represents to the other that it has read and understood the terms of this Agreement, and the consequences of executing this Agreement, and that except as expressly set forth herein, no representations have been made to induce the other Party to execute this contract.

Section 11.31. Multiple Counterparts. This Agreement may be signed in multiple counterparts or with detachable signature pages, but either or both circumstances shall constitute one instrument, binding upon all parties thereto as if all parties signed the same document. If so executed, each such counterpart of this Agreement is to be deemed an original for all purposes and all such counterparts will collectively constitute one Agreement, but in making proof of this Agreement, it will not be necessary to produce or account for more than one such counterpart.

Section 11.32. Entire Agreement. This Agreement, including any explicitly stated and attached Exhibit(s), constitutes the full, final, and entire agreement of the parties and incorporates all of the conditions, agreements, understandings and negotiations between the parties concerning the subject matter of this contract, and all such agreements, conditions, understandings and negotiations have been merged into this written Agreement. No prior condition, agreement, understanding, or negotiation, verbal or otherwise, of the parties or their agents shall be valid or enforceable unless embodied in writing in this Agreement.

Section 11.33. Intentionally deleted.

Section 11.34. Survival. All obligations, covenants, and agreements contained herein which are not performed at or before the completion of construction of the Project but which are to be performed after the completion of construction of the Project as provided in this Agreement, or

which otherwise by their nature are intended to survive the Term, shall survive the completion of construction of the Project.

Section 11.35. Approval Required. This Agreement shall not become effective or binding until approved by the highest approval authority required by the City under this Agreement.

Section 11.36. Intentionally deleted.

Section 11.37 Interpretation.

A. The words "City" and "Developer" as used herein, will include, as the context may permit or require, the parties executing this Agreement and their respective heirs, executors, administrators, successors, and assigns.

B. Unless expressly provided to the contrary, the phrases "during the term of this Agreement" and "during the term hereof" will include such periods during which the term of this Agreement is actually extended pursuant to the exercise by Developer of option(s) to extend the term hereof.

C. This Agreement has been negotiated at arm's length and between persons sophisticated and knowledgeable in the matters dealt with in this Agreement. In addition, each Party has been given the opportunity to consult experienced and knowledgeable legal counsel. Accordingly, any rule of law or legal decision that would require interpretation of any ambiguities in this Agreement against the party that has drafted it is not applicable and is waived. The provisions of this Agreement will be interpreted in a reasonable manner to affect the purpose of the parties and this Agreement.

Section 11.38. Final Dates. If the final date of any deadline falls upon a Saturday, Sunday, or holiday recognized by the U.S. Postal Service, then in such event the time of such deadline will be extended to the next day that is not a Saturday, Sunday, or holiday recognized by the U. S. Postal Service. Whenever the word "days" is used herein, it will be considered to mean "calendar days" and not "business days" unless an express statement to the contrary is made.

Section 11.39. City-Developer Relationship. The City will in no event be construed or held to be a partner, joint venture or associate of the Developer in the conduct of the Developer's business, nor will the City be liable for any debts incurred by the Developer in the Developer's business. The relationship is and at all times will remain contractual.

THIS SPACE INTENTIONALLY LEFT BLANK

IN WITNESS WHEREOF the City and Developer have caused this Agreement to be executed in their respective names and all as of the date first written above

CITY OF ALBUQUERQUE

Approved By:

NAME
Chief Administrative Officer

Date: _____g

STATE OF NEW MEXICO)
)
COUNTY OF BERNALILLO)

This instrument was acknowledged before me this _____ day of _____, 2021, by NAME as Chief Administrative Officer of the City of Albuquerque, a New Mexico municipal corporation.

Notary Public

My Commission Expires: _____

THIS SPACE INTENTIONALLY LEFT BLANK

IN WITNESS WHEREOF the City and Developer have caused this Agreement to be executed in their respective names and all as of the date first written above.

The Villa Agave LLC

Approved By:

Mark Baker, AIA

Date: _____

STATE OF NEW MEXICO)
)
COUNTY OF BERNALILLO)

This instrument was acknowledged before me this _____ day of _____, 2021, by Mark Baker as Owner of The Villa Agave, LLC, a New Mexico limited liability corporation.

Notary Public

My Commission Expires: _____

ALTA/ACSM SURVEY

SURVEY LEGAL DESCRIPTION:

Lots numbered Thirteen (13), Fourteen (14), Fifteen (15), Sixteen (16), Seventeen (17), Eighteen (18), Nineteen (19) and the East One-half (E. 1/2) Lot numbered Twenty (20) in Block numbered Seven (7) of the NEW MEXICO TOWN COMPANY'S ORIGINAL TOWNSITE of Albuquerque, New Mexico, as the same is shown and designated on the Map of said Townsite filed in the office of the Probate clerk and Ex-Officio Recorder of Bernalillo County, New Mexico on December 29, 1882.

SURVEYOR'S CERTIFICATION:

TO:
(BUYER), Roman Catholic Church of the Archdiocese of Santa Fe
(LENDER),

(TITLE COMPANY), Fidelity National Title Company
(UNDERWRITER), Fidelity National Title Insurance Company

This is to certify that this map or plot and the survey on which it is based were made in accordance with "Minimum Standard Detail Requirements for ALTA/ACSM Land Title Surveys", jointly established and adopted by ALTA, ACSM and NSPS in 2011, and includes Items 1, 2, 3, 4, 5, 6, 7(a), 7(b), 7(c), 8, 9, 10, 11(a) (location of utilities per visible, above-ground, on-site observation) & 13 of Table A thereof. Pursuant to the Accuracy Standards as adopted by ALTA, NSPS and ACSM and in effect on the date of this certification, undersigned further certifies that the Positional Uncertainties resulting from the survey measurements made on the survey do not exceed the allowable Positional Tolerance.

Thomas D. Johnston, NMPS 14269

January 7, 2015 REVISED 6/14/16 TO ADD LOTS 17-19 & E/2 20

WAYJOHN SURVEYING, INC.



NOTES CORRESPONDING TO SCHEDULE B:

FIDELITY TITLE INSURANCE COMPANY COMMITMENT NO. FT000171192- STONEBERGERD EFFECTIVE DATE DECEMBER 9, 2014 AT 8:00 A.M.

- ① Any and all rights, claims, liens or equities in favor of the Middle Rio Grande Conservancy District which may affect the subject premises. May affect subject property. Item is not plotted hereon.

SURVEYOR'S NOTES:

1. INGRESS AND EGRESS TO THE SUBJECT PROPERTY IS PROVIDED BY COPPER AVENUE, NW; 7TH STREET, NW; AND A PUBLIC ALLEY, DEDICATED AND ACCEPTED RIGHTS-OF-WAY MAINTAINED BY THE CITY OF ALBUQUERQUE.
2. THE TITLE LINES AND ACTUAL POSSESSION LINES ARE THE SAME.
3. THE SUBJECT PROPERTY IS NOT SERVED AND IS NOT SERVICED BY ANY ADJOINING PROPERTY FOR DRAINAGE, INGRESS AND EGRESS EXCEPT AS SHOWN.
4. MONUMENTATION RECOVERED, ACCEPTED OR SET IS AS NOTED HEREON.

BASIS OF BEARINGS:

BEARINGS SHOWN HEREON ARE NEW MEXICO STATE PLANE GRID. ALL BEARINGS AND DISTANCES ARE FIELD MEASURED. RECORD BEARINGS AND/OR DISTANCES ARE SHOWN IN PARENTHESES.

FLOOD INFORMATION:

THIS PROPERTY DOES LIE IN AN AREA COVERED BY A FORMAL F.E.M.A. FLOOD STUDY. PROPERTY LIES WITHIN ZONE "X" (NO Flood Hazard) AND IS NOT SUBJECT TO 100-YEAR FLOOD HAZARDS. REFERENCE: FLOOD INSURANCE RATE MAP, ALBUQUERQUE, BERNALILLO COUNTY, NEW MEXICO PANEL 350002 0334 G; EFFECTIVE DATE: SEPTEMBER 26, 2008.

STATEMENT OF ENCROACHMENTS:

- (A) Building encroaches into Lot 17 to a maximum extent of 3.94 feet as shown.
- (B) Stairs and basement window wells encroach into Lot 17 as shown.

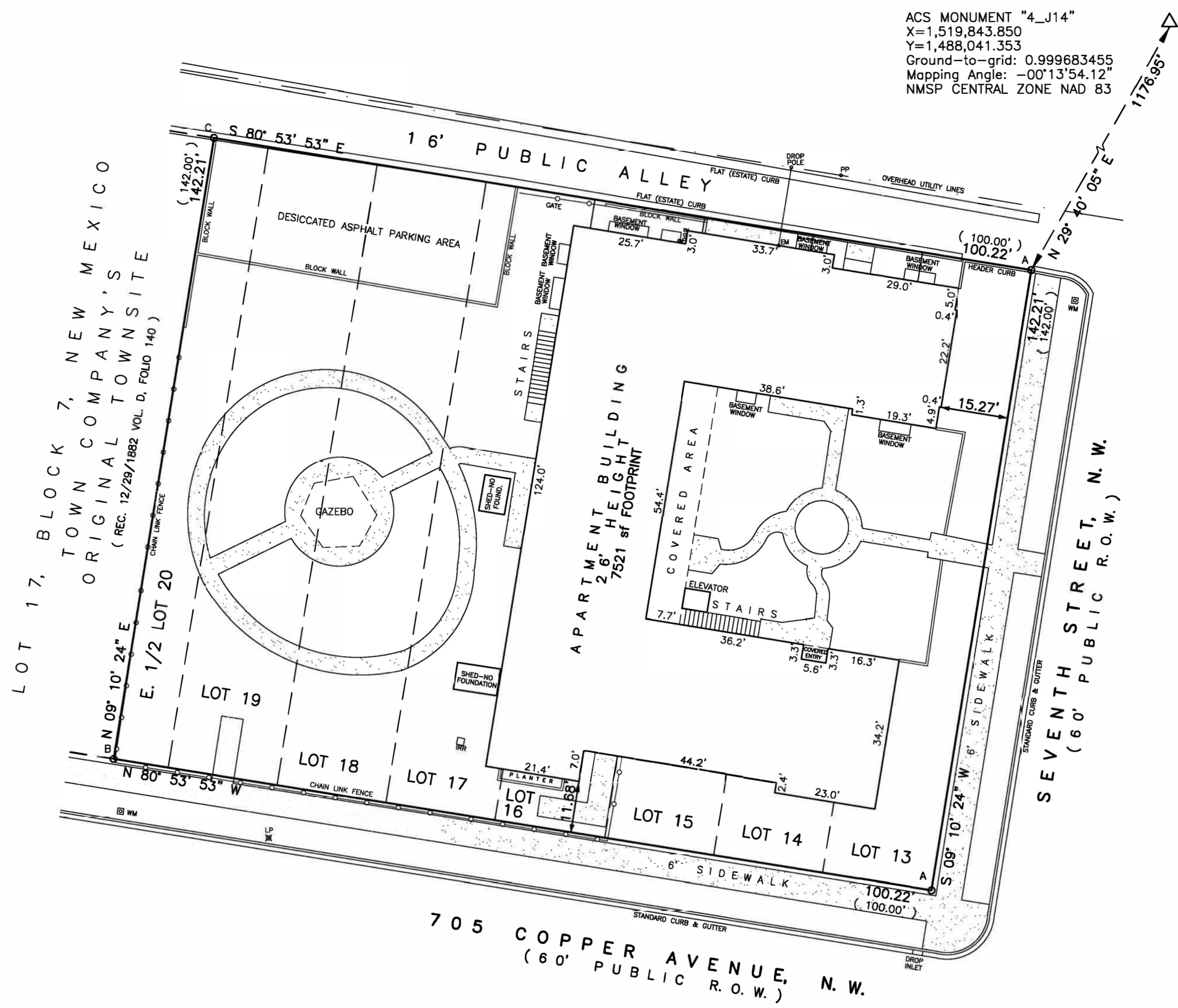

ACS MONUMENT "4_U14"
X=1,519,843.850
Y=1,488,041.353
Ground-to-grid: 0.999683455
Mapping Angle: -00°13'54.12"
NAD 83

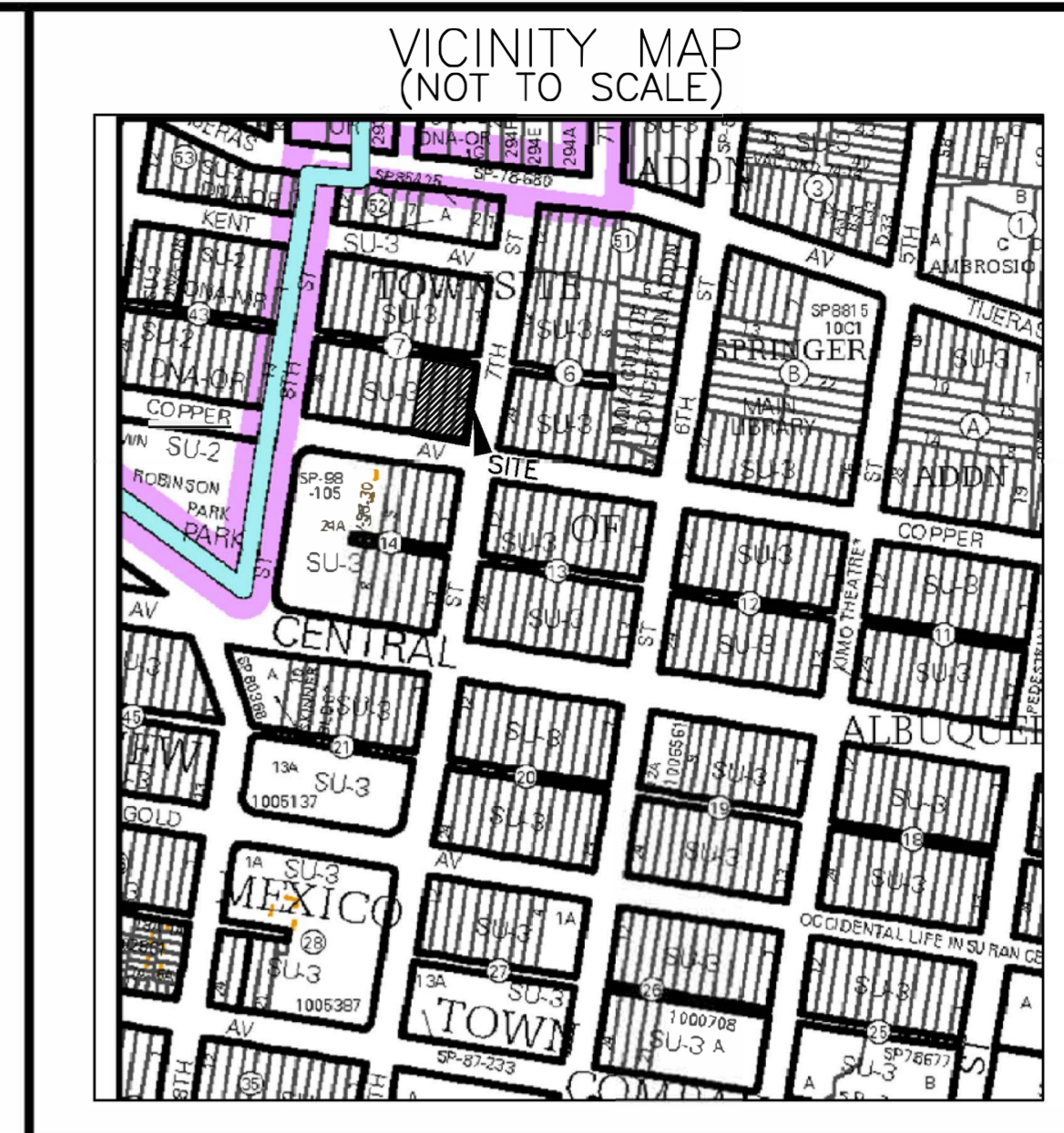

SITE RESTRICTIONS:
SETBACKS:
FRONT: 0 FEET
SIDE: 0 FEET (11' ADJACENT TO DRIVEWAY OR SIDEWALK)
REAR: 0 FEET
HEIGHT: 26' PERMISSIBLE
LOT SIZE: NO REQUIREMENTS
LOT WIDTH: NO MINIMUM
ZONE: SU-3 SPECIAL CENTER ZONE
SITE RESTRICTIONS ARE AVAILABLE FROM CITY OF ALBUQUERQUE ZONING CODE. CITY OF ALBUQUERQUE ZONING DEPARTMENT (505) 924-3860.

LEGEND:

- PP UTILITY POLE
- GUY ANCHOR
- IRR IRRIGATION VALVE
- ⊗ WM WATER METER
- ⊗ WV WATER VALVE
- ⊗ FH FIRE HYDRANT
- ⊗ LP LIGHT POLE
- EM ELECTRIC METER
- GM GAS METER
- CO SEWER CLEANOUT
- TM TELEPHONE MANHOLE

AREA:
14,258.11 sq. ft
0.3273 Acres

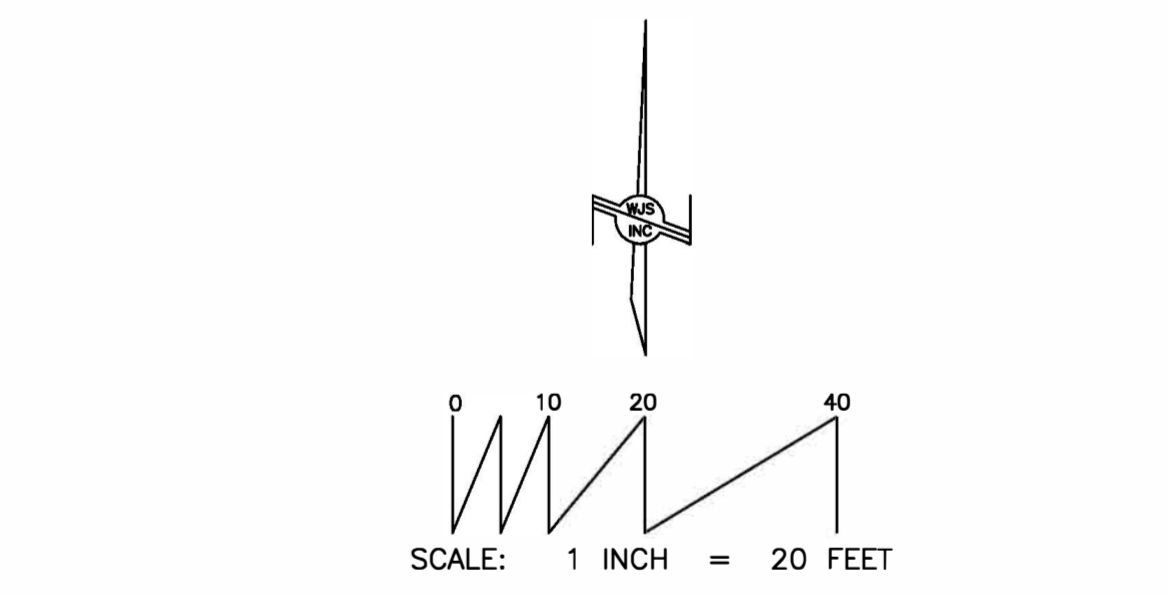

FOUND/SET MONUMENT LEGEND:
○A: FOUND 2" STEEL PIPE
B: SET #4 REBAR AND CAP "WAYJOHN PS 14269"
C: SET PK NAIL AND DISK IN PILASTER

WAYJOHN SURVEYING INC.

330 Louisiana Blvd, N.E. Albuquerque, NM 87108
Phone: (505) 255-2052 Fax: (505) 255-2387

Date of Survey: 1/6/15; 6/14/16 Draftsman: T D J
Date of Last Revision: 6/14/16 Job No.: ALTA-12-03-2014

Exhibit B

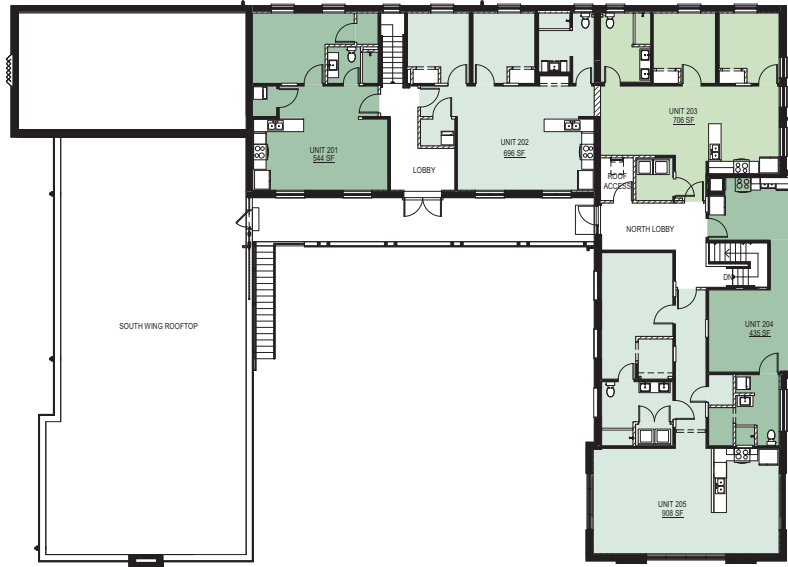

2nd Floor Plan

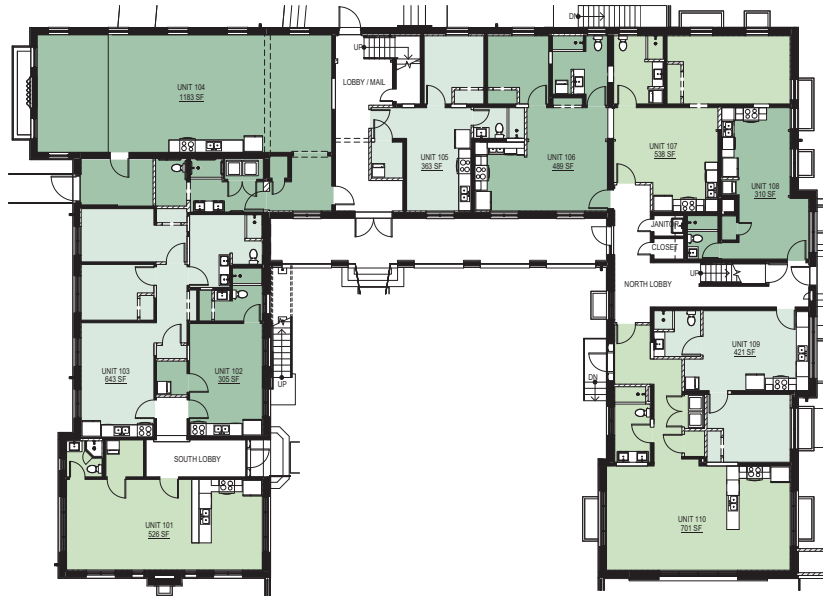

1st Floor Plan

- Apartment Unit
- Tenant Storage

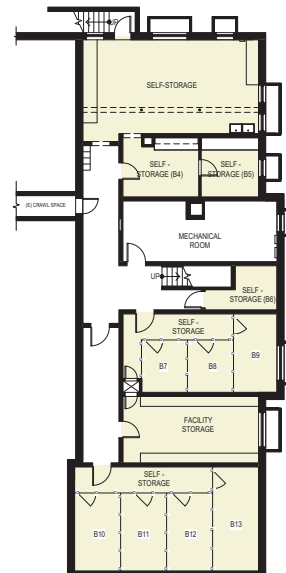

Basement

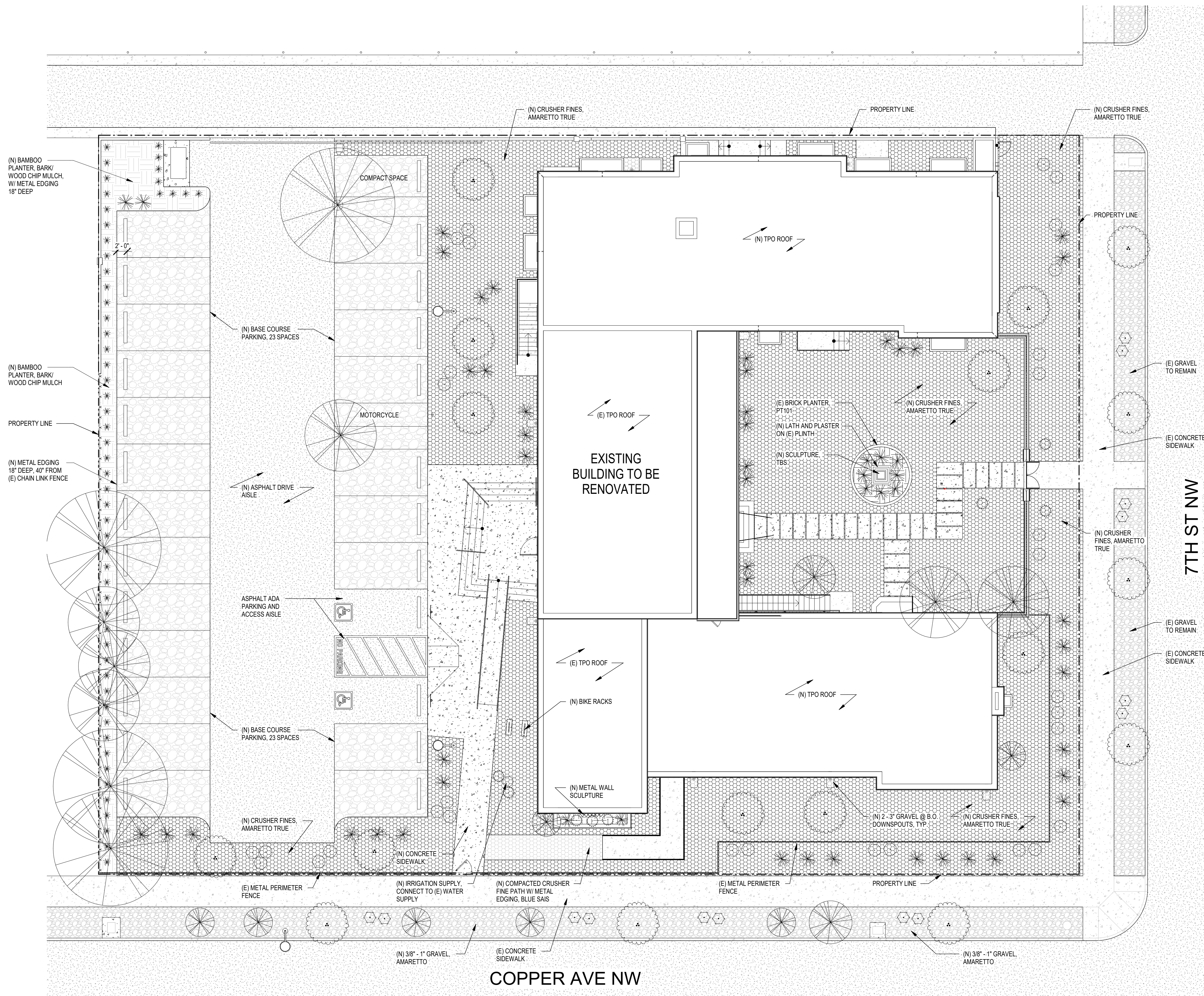

WALL AND FENCE PER CITY OF ALBUQUERQUE IDO REQUIREMENTS

MAXIMUM WALL HEIGHT TABLE 5-7(D)(1)

ZONE CATEGORY	MIXED-USE
STANDARD WALL HEIGHT	
WALL IN THE FRONT YARD OR STREET SIDE YARD ⁽²⁾	3 FT
WALL IN OTHER LOCATIONS ON THE LOT	8 FT

⁽²⁾ TALLER WALLS MAY BE APPROVED FOR MULTI-FAMILY RESIDENTIAL DEVELOPMENT PURSUANT TO SUBSECTION 14-16-5-7(D)(3)

EXCEPTIONS TO MAXIMUM WALL HEIGHT 5-7(D)(3)
5-7(D)(3)(c) FOR MULTI-FAMILY RESIDENTIAL DEVELOPMENT, THE MAXIMUM HEIGHT IS 6 FEET IF VIEW FENCING IS USED FOR PORTIONS OF A WALL ABOVE 3 FEET.

CLEAR SIGHT REQUIREMENTS:
LANDSCAPING AND SIGNAGE WILL NOT INTERFERE WITH CLEAR SIGHT REQUIREMENTS. THEREFORE, SIGNS, WALLS, TREES AND SHRUBBERY BETWEEN 3 AND 8 FEET TALL (AS MEASURED FROM THE GUTTER PAN) WILL NOT BE ACCEPTABLE IN THE CLEAR SIGHT TRIANGLE.

HATCH LEGEND

- (N) CONCRETE, 4" THICK, 3000 PSI
- CRUSHER FINES, AMARETTO TRUE, U.N.O., 3" THICK, NO FILTER FABRIC
- 4" ASPHALT OVER 6" BASE COURSE
- (N) 3/8" - 1" GRAVEL, AMARETTO, U.N.O.
- BASE COURSE, 6" OVER COMPACTED SUBGRADE

PLANTING LEGEND

- TREES**
- EXISTING TREE TO REMAIN, SIZE VARIES
 - DESERT WILLOW, 24" BOX MIN. SIZE, MULTI-TRUNK
- SHRUBS**
- AGAVE, 5 GAL., SPECIES TO BE SELECTED
 - OPUNTIA, "PRICKLY PEAR"
 - YUCCA BACCATA, BANANA YUCCA, 3 GAL.
- GRASSES**
- "BLONDE AMBITION" GRAMA GRASSES, 2 GAL.
 - GOLDEN BAMBOO, 2 GAL., SPACE @ 36" O.C.



CONSULTANTS

THE VILLA
RESIDENCES AT 205 7TH STREET NW

MARK DATE DESCRIPTION

B_AD PROJECT #	2106
FILE:	220203_THE VILLA.RVT
DATE:	3/9/2022
DRAWN BY:	CM
CHECKED BY:	MRB

LANDSCAPE PLAN

AS-101
SHEET OF

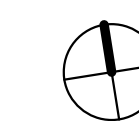



VILLA AGAVE RFP RESPONSE

To download the RFP response, click [here](#).