



Supplemental Form (SF)

<input type="checkbox"/> Major subdivision action	<input checked="" type="checkbox"/> S	<input checked="" type="checkbox"/> Z	ZONING & PLANNING
<input type="checkbox"/> Minor subdivision action			Annexation
<input type="checkbox"/> Vacation	<input checked="" type="checkbox"/> V	<input checked="" type="checkbox"/> X	Zone Map Amendment (Establish or Change Zoning, includes Zoning within Sector Development Plans)
<input type="checkbox"/> Variance (Non-Zoning)			
SITE DEVELOPMENT PLAN	<input type="checkbox"/> P		Adoption of Rank 2 or 3 Plan or similar Text Amendment to Adopted Rank 1, 2 or 3 Plan(s), Zoning Code, or Subd. Regulations
<input type="checkbox"/> for Subdivision			
<input type="checkbox"/> for Building Permit			
<input type="checkbox"/> Administrative Amendment/Approval (AA)			
<input type="checkbox"/> IP Master Development Plan	<input type="checkbox"/> D		Street Name Change (Local & Collector)
<input type="checkbox"/> Cert. of Appropriateness (LUCC)	<input type="checkbox"/> L	<input checked="" type="checkbox"/> A	APPEAL / PROTEST of...
STORM DRAINAGE (Form D)			Decision by: DRB, EPC, LUCC, Planning Director, ZEO, ZHE, Board of Appeals, other
<input type="checkbox"/> Storm Drainage Cost Allocation Plan			

PRINT OR TYPE IN BLACK INK ONLY. The applicant or agent must submit the completed application in person to the Planning Department Development Services Center, 600 2nd Street NW, Albuquerque, NM 87102. Fees must be paid at the time of application. Refer to supplemental forms for submittal requirements.

APPLICATION INFORMATION:

Professional/Agent (if any): Angela Benson - DSA Architects PHONE: (505) 342-62
 ADDRESS: 4700 Lincoln Road NE, Suite 111 FAX: (505) 342-62
 CITY: Albuquerque STATE NM, ZIP 87109 E-MAIL: angela.b@dsaaby
 APPLICANT: Catholic Charities Foundation PHONE: (505) 724-467
 ADDRESS: 3301 Candelaria Rd. NE, Suite B FAX: (505) 254-2623
 CITY: Albuquerque STATE NM, ZIP 87107 E-MAIL: gannonj@ccasn
 Proprietary interest in site: owner List all owners: Catholic Charities

DESCRIPTION OF REQUEST: Annexation Petition of two parcels and Zone Map Establishment of O-1.

Is the applicant seeking incentives pursuant to the Family Housing Development Program? Yes. No.

SITE INFORMATION: ACCURACY OF THE EXISTING LEGAL DESCRIPTION IS CRUCIAL! ATTACH A SEPARATE SHEET IF NECESSARY.

Lot or Tract No. 148A1B, 147B1, 147B2A, 148A1A Block: 6000 Unit: _____
 Subdiv/Addn/TBKA: 2012 and 2034 1A1A1 Bridge Blvd. SW.
 Existing Zoning: C-N and R-1 Proposed zoning: City O-1 MRGCD Map No. 42
 Zone Atlas page(s): L-12 UPC Code: 10120561222 593 0821
10120561242 72 30819

CASE HISTORY:

List any current or prior case number that may be relevant to your application (Proj., App., DRB-, AX_Z_V_S, etc.):
County of Bernalillo AXBC-20136001

CASE INFORMATION:

Within city limits? Yes No Within 1000FT of a landfill? No
 No. of existing lots: 2 No. of proposed lots: 2 Total site area (acres): 1.37 Acres
 LOCATION OF PROPERTY BY STREETS: On or Near: Bridge Blvd.
 Between: Anthony Lane and Pear Road

Check if project was previously reviewed by: Sketch Plat/Plan or Pre-application Review Team(PRT) Review Date: _____

SIGNATURE Angela Benson (Agent) DSA Architects DATE 8/26/2014
 (Print Name) Angela Benson (Agent) DSA Architects Applicant: Agent:

FOR OFFICIAL USE ONLY

Revised: 4/2012

<input checked="" type="checkbox"/> INTERNAL ROUTING	Application case numbers	Action	S.F.	Fees
<input checked="" type="checkbox"/> All checklists are complete	<u>14 EPC - 40059</u>	<u>Annexation</u>		<u>\$ 0</u>
<input checked="" type="checkbox"/> All fees have been collected	<u>40060</u>	<u>AZM</u>		<u>\$ 275.00</u>
<input checked="" type="checkbox"/> All case #s are assigned		<u>CMF</u>		<u>\$ 50.00</u>
<input checked="" type="checkbox"/> AGIS copy has been sent		<u>ADV</u>		<u>\$ 75.00</u>
<input checked="" type="checkbox"/> Case history #s are listed				<u>\$</u>
<input type="checkbox"/> Site is within 1000ft of a landfill				<u>\$</u>
<input type="checkbox"/> F.H.D.P. density bonus				<u>\$</u>
<input type="checkbox"/> F.H.D.P. fee rebate				<u>\$</u>
	Hearing date <u>Oct. 9, 2014</u>			Total <u>\$ 420.00</u>

[Signature] 8-27-14
 Staff signature & Date

Project # 1010208

FORM Z: ZONE CODE TEXT & MAP AMENDMENTS, PLAN APPROVALS & AMENDMENTS

ANNEXATION (EPC08)

- Application for zone map amendment including those submittal requirements (see below).
Annexation and establishment of zoning must be applied for simultaneously.
 - Petition for Annexation Form and necessary attachments
 - Zone Atlas map with the entire property(ies) clearly outlined and indicated
NOTE: The Zone Atlas must show that the site is in County jurisdiction, but is contiguous to City limits.
 - Letter describing, explaining, and justifying the request
NOTE: Justifications must adhere to the policies contained in "Resolution 54-1990"
 - Letter of authorization from the property owner if application is submitted by an agent
 - Board of County Commissioners (BCC) Notice of Decision
 - Office of Neighborhood Coordination (ONC) inquiry response form, notification letter(s), certified mail receipts
 - Sign Posting Agreement form
 - Traffic Impact Study (TIS) form
 - List any original and/or related file numbers on the cover application
- EPC hearings are approximately 7 weeks after the filing deadline.* Your attendance is required.

- SDP PHASE I – DRB CONCEPTUAL PLAN REVIEW (DRBPH1)** (Unadvertised)
 - SDP PHASE II - EPC FINAL REVIEW & APPROVAL (EPC14)** (Public Hearing)
 - SDP PHASE II - DRB FINAL SIGN-OFF (DRBPH2)** (Unadvertised)
 - Copy of findings from required pre-application meeting (needed for the DRB conceptual plan review only)
 - Proposed Sector Plan (30 copies for EPC, 6 copies for DRB)
 - Zone Atlas map with the entire plan area clearly outlined and indicated
 - Letter describing, explaining, and justifying the request
 - Office of Neighborhood Coordination (ONC) inquiry response form, notification letter(s), certified mail receipts (for EPC public hearing only)
 - Traffic Impact Study (TIS) form (for EPC public hearing only)
 - Fee for EPC final approval only (see schedule)
 - List any original and/or related file numbers on the cover application
- Refer to the schedules for the dates, times and places of DRB and EPC hearings.* Your attendance is required.

AMENDMENT TO ZONE MAP - ESTABLISHMENT OF ZONING OR ZONE CHANGE (EPC05)

- Zone Atlas map with the entire property clearly outlined and indicated
 - Letter describing, explaining, and justifying the request pursuant to Resolution 270-1980.
 - Letter of authorization from the property owner if application is submitted by an agent
 - Office of Neighborhood Coordination (ONC) inquiry response form, notification letter(s), certified mail receipts
 - Sign Posting Agreement form
 - Traffic Impact Study (TIS) form
 - Fee (see schedule)
 - List any original and/or related file numbers on the cover application
- EPC hearings are approximately 7 weeks after the filing deadline.* Your attendance is required.

- AMENDED TO SECTOR DEVELOPMENT MAP (EPC03)**
 - AMENDMENT SECTOR DEVELOPMENT, AREA, FACILITY, OR COMPREHENSIVE PLAN (EPC04)**
 - Proposed Amendment referenced to the materials in the Plan being amended (text and/or map)
 - Plan to be amended with materials to be changed noted and marked
 - Zone Atlas map with the entire plan/amendment area clearly outlined
 - Letter of authorization from the property owner if application is submitted by an agent (map change only)
 - Letter describing, explaining, and justifying the request pursuant to Resolution 270-1980 (Sector Plan map change only)
 - Letter briefly describing, explaining, and justifying the request
 - Office of Neighborhood Coordination (ONC) inquiry response form, notification letter(s), certified mail receipts (for sector plans only)
 - Traffic Impact Study (TIS) form
 - Sign Posting Agreement
 - Fee (see schedule)
 - List any original and/or related file numbers on the cover application
- EPC hearings are approximately 7 weeks after the filing deadline.* Your attendance is required.

- AMENDMENT TO ZONING CODE OR SUBDIVISION REGULATORY TEXT (EPC07)**
 - Amendment referenced to the sections of the Zone Code/Subdivision Regulations being amended
 - Sections of the Zone Code/Subdivision Regulations to be amended with text to be changed noted and marked
 - Letter describing, explaining, and justifying the request
 - Fee (see schedule)
 - List any original and/or related file numbers on the cover application
- EPC hearings are approximately 7 weeks after the filing deadline.* Your attendance is required.

I, the applicant, acknowledge that any information required but not submitted with this application will likely result in deferral of actions.

DSA Architects
 Angela Benson (Agent) - 8/27/14
 Applicant name (print)
 Angela M Benson, Agent
 Applicant signature & Date



- Checklists complete
 - Fees collected
 - Case #s assigned
 - Related #s listed
- Application case numbers
 14 EPC - 40059
 - 40060
 -

Revised: June 2011

 8-27-14
 Staff signature & Date
 Project # 1010208

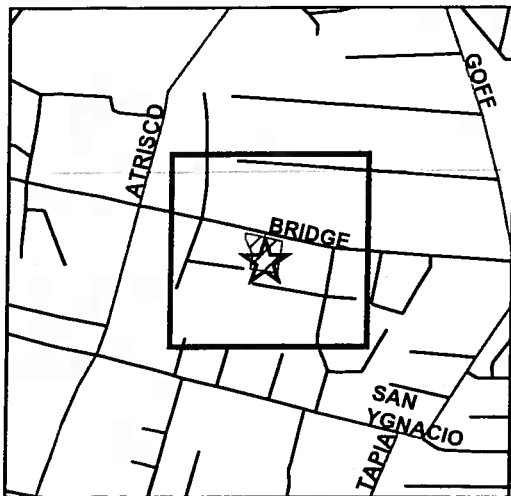
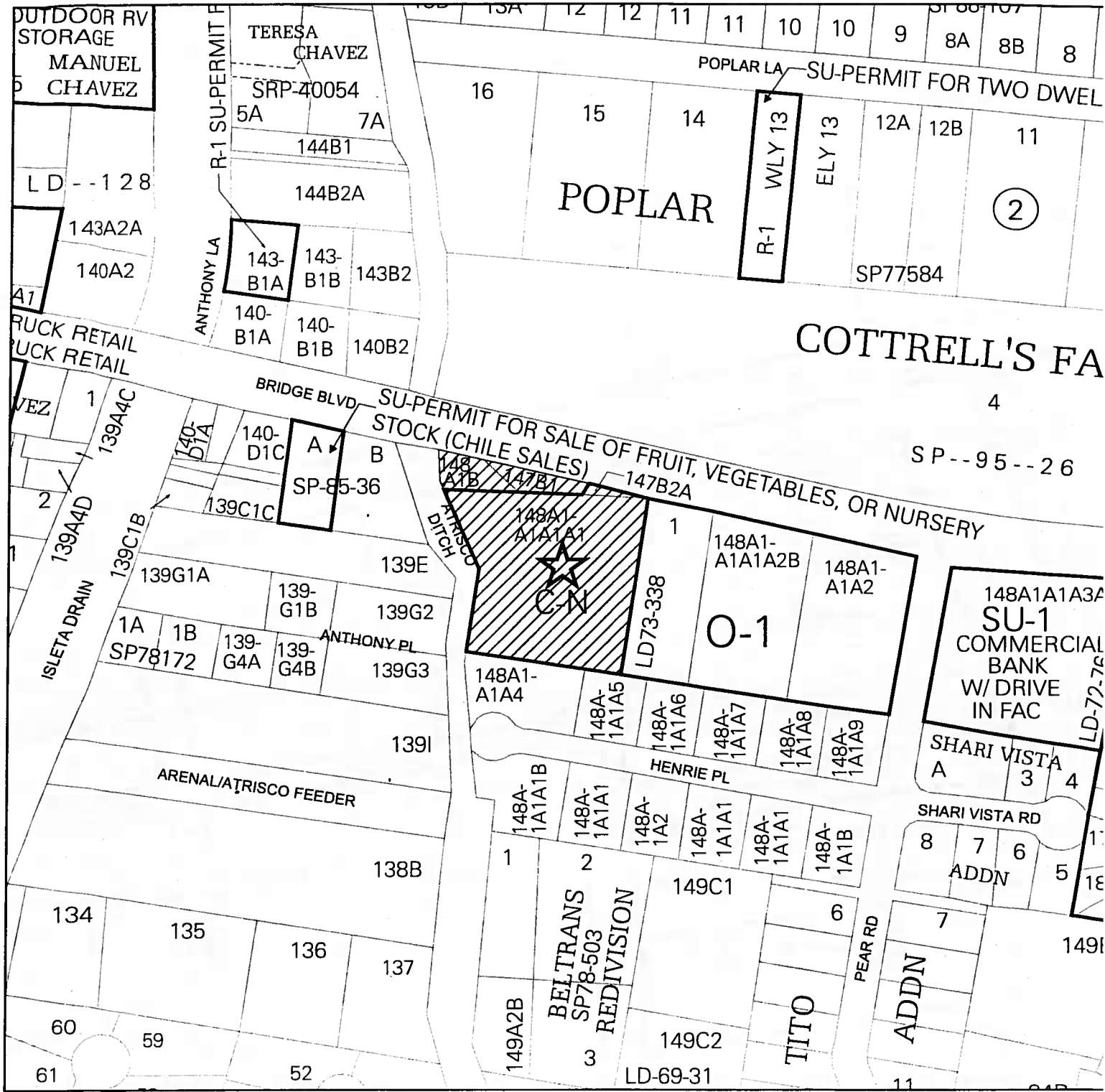

ZONING MAP

Note: Grey shading indicates County.



1 inch = 200 feet

Project Number:
1010208
Hearing Date:
10-9-2014
Zone Map Page: I-12
Additional Case Number:
14EPC 40059 & 40060

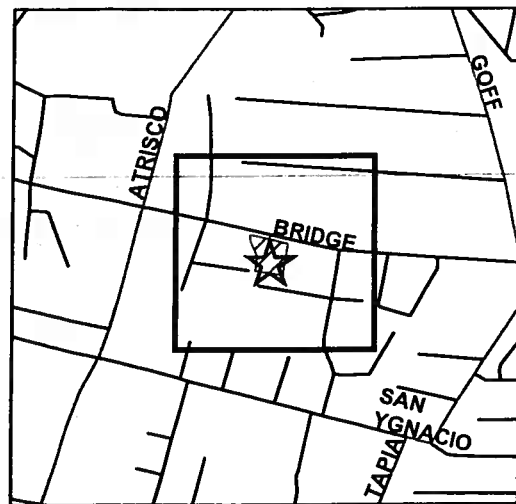

LAND USE MAP

Note: Grey shading indicates County.

KEY to Land Use Abbreviations

- AGRI Agriculture
- COMM Commercial - Retail
- CMSV Commercial - Service
- DRNG Drainage
- MFG Manufacturing
- MULT Multi-Family or Group Home
- PARK Park, Recreation, or Open Space
- PRKG Parking
- PUBF Public Facility
- SF Single Family
- TRAN Transportation Facility
- VAC Vacant Land or Abandoned Buildings
- WH Warehousing & Storage



1 inch = 200 feet

Project Number:
1010208
Hearing Date:
10-9-2014
Zone Map Page: I-12
Additional Case Number:
14EPC 40059 & 40060

SU-69-67

CRM-86-11

POPLAR LA

ANTHONY LA

Z-78-59

CSU-70-7

DRB

CZ-88-15

CSU-89-33

ATRISCO DITCH

CZ-78-15

BRIDGE BLVD

Z-1480

Z-70-15

ZA-76-43

Z-76-15

Z-1517

Z-74-4

AX-79

AX-89

Z-1480

Z-1426

S-1396

SHARI VISTA RD

ISLETA DRAIN

ANTHONY PL

ARENAL/ATRISCO FEEDER

HENRIE PL

PEAR RD



HISTORY MAP

Note: Grey shading indicates County.



1 inch = 200 feet

Project Number:

1010208

Hearing Date:

10-9-2014

Zone Map Page: I-12

Additional Case Number

14EPC 40059 & 40060

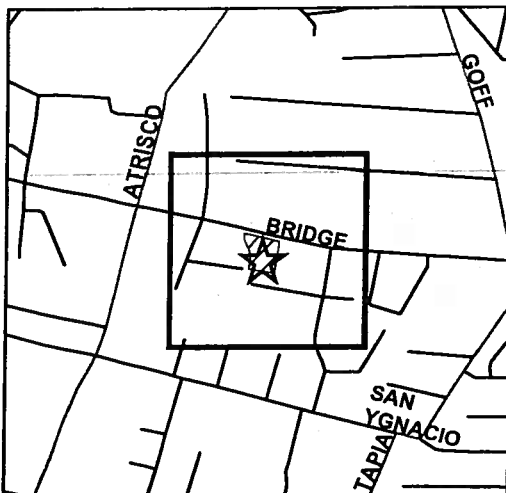

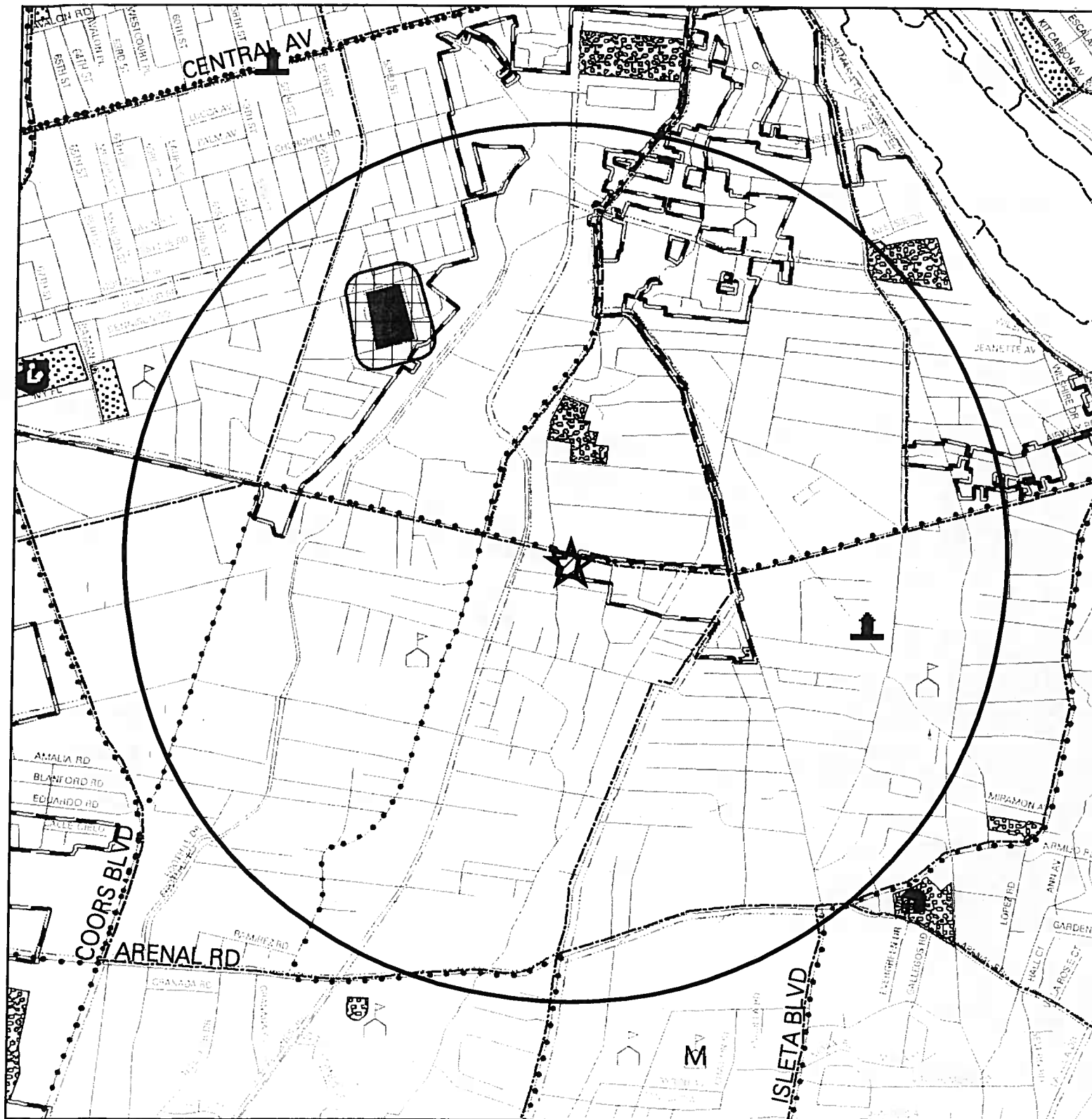

Public Facilities Map with One-Mile Buffer



- | | | | |
|----------------------|-------------------------|---------------------------|-----------------------------|
| COMMUNITY CENTER | FIRE | APS Schools | Landfill Buffer (1000 feet) |
| MULTI-SERVICE CENTER | POLICE | ABQ Ride Routes | Landfills designated by EHD |
| SENIOR CENTER | SHERIFF | ----- ABQ Bike Facilities | Developed County Park |
| LIBRARY | SOLID WASTE | Proposed Bike Facilities | Undeveloped County Park |
| MUSEUM | Albuquerque City Limits | | Developed City Park |
| | | | Undeveloped City Park |

Project Number: 1010208

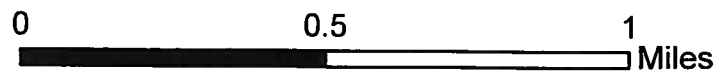

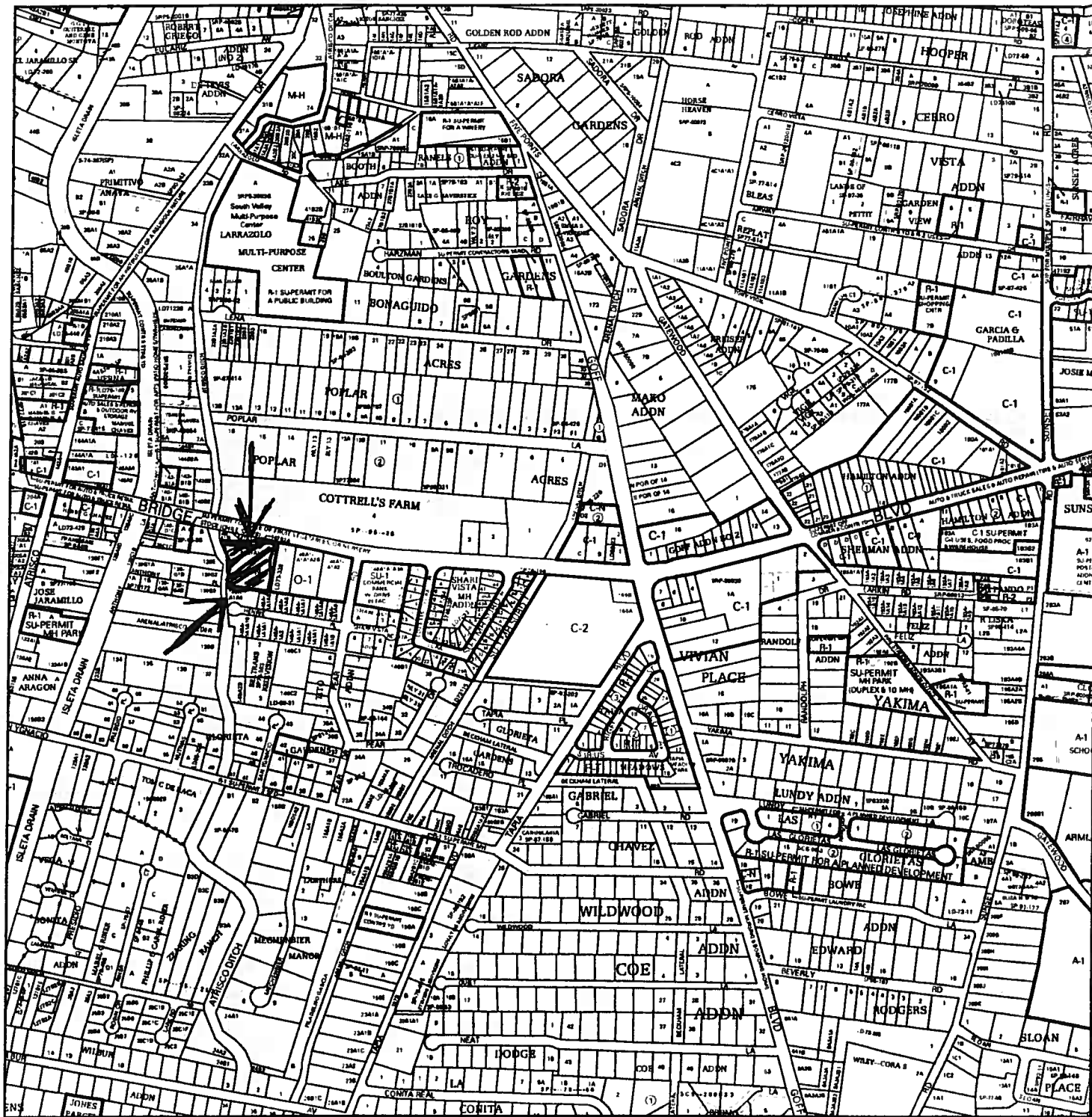

For more current information and details visit: <http://www.cabq.gov/gis>

Map amended through: 6/7/2013

Zone Atlas Page:
L-12-Z

Selected Symbols

SECTOR PLANS	Escarpment
Design Overlay Zones	2 Mile Airport Zone
City Historic Zones	Airport Noise Contours
H-1 Buffer Zone	Wall Overlay Zone
Petroglyph Mon.	

Note: Grey Shading Represents Area Outside of the City Limits



**CITY OF ALBUQUERQUE
PETITION FOR ANNEXATION**

INSTRUCTIONS: TYPE OR PRINT IN BLACK INK ONLY. Use additional sheets if necessary. The applicant must provide an exhibit that accurately describes the boundaries of the property to be annexed. This requires a property boundary survey prepared by a licensed professional surveyor unless the exact boundaries of the property are already platted. Other attachments may include a site development plan. Provide thirty (30) copies of any required attachment. Please fold large format attachments to 8-1/2 x 14 inches maximum.

1. LEGAL DESCRIPTION OF AREA PROPOSED FOR ANNEXATION:
MRGCD Tracts 148A1B, 147B1, 147B2A
and 148A1A1A1A1 located at 2012 and
2034 Bridge Blvd. SW.
2. TOTAL ACREAGE OF AREA: 1.37 Acres
3. REASON FOR ANNEXATION: (Briefly summarize the letter of explanation submitted with your application.) Request is to unify the zoning of an existing City parcel with O-1 zoning to allow for the expansion of the existing use.
4. CAPITAL IMPROVEMENTS FOR STREETS, WATER, SANITARY SEWER AND STORM DRAINAGE.

THE APPLICANT(S) AND CITY AGREE THAT:

- A. Capital improvements will be funded by special assessment districts (SADs) and/or other funding sources.
- B. The City provides funding through the Capital Improvements Program (CIP), and unless a project is specifically identified in the CIP, the timing of City funded improvements is indefinite.
- C. In the absence of public funding for required improvements, the land owner(s) or their successors in interest shall install, or cause to be installed, any such improvements in a manner that satisfies City policies and standards.
- D. A Pre-Annexation Agreement for the provision of certain infrastructure improvements is required, except if the application will result in ten (10) or less residential dwelling units.
- E. The Pre-Annexation Agreement must be completed and reviewed by the City Engineer (who will make a recommendation) prior to the EPC hearing of the annexation request.

5. PROPOSED ZONING: O-1
Apply for a sector plan map amendment if needed.

6. SIGNATURE (S):

- A. OWNER Catholic Charities Foundation Phone 724-4670
Mailing Address 6001 Marble Ave. NE E-mail _____
Legal Description of this owner's property As stated above
Acreage 1.37 Signature/Date [Signature]
- B. OWNER _____ Phone _____
Mailing Address _____ E-mail _____
Legal Description of this owner's property _____
Acreage _____ Signature/Date _____
- C. OWNER _____ Phone _____
Mailing Address _____ E-mail _____
Legal Description of this owner's property _____
Acreage _____ Signature/Date _____

Attach additional signatures as necessary.



Darren Sowell

ARCHITECTS

www.dsaabq.com

505.342.6200

City of Albuquerque
Environmental Planning Commission
Plaza del Sol, 600 Second NW
Albuquerque, New Mexico 87102
Telephone: (505) 924-3860

August 25, 2014

Catholic Charities - Annexation Petition and Zone Map Amendment Request, In Accordance with Resolution 270-1980

This is a request for approval for annexation of 1.37 acres currently in the County of Bernalillo with split zoning of C-N and R-1. Concurrently, we are requesting the establishment of a zoning designation of O-1 (Office and Institution) in the City of Albuquerque. Catholic Charities, the owner of both parcels also owns the adjacent parcel to the east which is developed as Catholic Charities Bridge Street Campus. The subject properties are located on the south side of Bridge Boulevard between Pear Road and the Atrisco Ditch. The property currently has R-1 and C-N zoning, with the majority under C-N designation, the adjoining properties to the east of the subject site are within the jurisdiction of the City of Albuquerque and zoned O-1.

The annexation would allow the applicant to expand existing services and embark on one of its greatest endeavors to date—the construction of Catholic Charities' community service center known as *Casa de Corazon*. This project, in the heart of Albuquerque's South Valley, will allow Catholic Charities to create a single campus where essential services and programs can be distributed to individuals who seek assistance each year under one cohesive jurisdiction with a clear path forward for development.

On September 27, 2013 the Board of County Commissioners reviewed and approved the application for annexation into the City of Albuquerque. The 1.37 acre parcel request was found to have no adverse impacts to the provision of County services or on the surrounding lands remaining under the jurisdiction of Bernalillo County.

Further, annexation will provide continuity of local government oversight and public service to this property and establishment of the zoning designation of O-1 will allow Catholic Charities to expand the current campus under the City's jurisdiction, policies and regulations guiding desired development that will allow for the expansion of approximately +/- 28,000 sq. ft. of the Bridge Campus in accordance with Resolution 270-1980 (Appendix B):

- (A) **A proposed zone change must be found to be consistent with the health, safety, morals and general welfare of the City.**

The proposed zoning of O-1 will respect the location, intensity and design of new development, existing neighborhood values, natural environmental conditions and carrying capacities, scenic resources and resources of other social, cultural, recreational concerns because it is compatible with the adjacent O-1 zoning and will not overburden the existing natural or built environment. Furthermore, the

proposed O-1 zoning for the parcel to be annexed is consistent with the O-1 zoning in place at the existing Bridge Campus site to the east and will allow for cohesive development.

- (B) **Stability of land use zoning is desirable; therefore, the applicant must provide a sound justification for the change. The burden is on the applicant to show why the change should be made.**

The purpose of this request to change to COA O-1 is for consistent development and governing criteria for a cohesive expansion of the existing campus property to the east, which is zoned COA O-1. In addition O-1 (City of Albuquerque) zoning exist on a number of parcels directly adjacent to the subject site further east. The use and consistency of development will continue to be consistent with this request and will not create instability.

- (C) **A proposed change shall not be in significant conflict with adopted elements of the Comprehensive Plan or other City master plans and amendments thereto including privately developed area plans which have been adopted by the City.**

The subject site is in the Jurisdiction of the Southwest Area Plan (Rank 2). The goals of this plan state that Bridge Boulevard is a desirable location for commercial and office uses that would serve to meet the day-to-day needs of residents in the immediate area. Further, stores and offices could provide much needed additional services and economic activity for the area and diminish the potential for future river crossings by creating areas of education and services within this plan area.

Southwest Area Plan – Community Involvement and Services Policies – (pg. 83)
“To foster a healthy community, we want services, programs and educational resources that collaborate to invest in all individuals. We want opportunities to learn, access to health and social care, and public and private services that contribute to the well being of the community.

The very mission of Catholic Charities' is to create hope for those in need by promoting self-sufficiency, strengthening families, fighting poverty and building community. Catholic Charities in New Mexico has been dedicated to finding solutions to some of the most pressing social challenges individuals and families in our community face. Charities collaborate with various social service providers to address the needs of those in our community regardless of race, religion, country of origin, disabilities, gender or sexual orientation. Their goal is to provide clients and their families with the tools they need to become self-sufficient. Catholic charities is dedicated to taking aid to a higher level. In response to the increased need for services in the South Valley, Catholic Charities has embarked on one of its greatest endeavors to date—the construction of Catholic Charities' community service center known as *Casa de Corazon*. This project will also allow Catholic Charities to create a single campus where essential services and programs can be distributed to individuals who seek assistance each year.

Southwest Area Plan - Policy 37 – Public and private sectors shall work together to aid innovative programs that promote improved community services.

This project will allow Catholic Charities to create a single campus where essential services and programs will be offered to individuals who seek assistance each year. The reality is that each day, more and more people in this community are faced with economic uncertainty and long-term unemployment and are looking to Catholic Charities for assistance. While federal and state funding continues to decline, the need for services provided by Catholic Charities is growing exponentially.

Albuquerque/Bernalillo County Comprehensive Plan – “Promote neighborhood vitality, public safety, affordable housing, customer service, balanced infrastructure spending, sustainability and infill, economic vitality and cultural development; Reinforce and expand interest in and sense of community as evidenced by the growth of neighborhood organizations and other special purpose community organizations;”

This project is the epitome of providing “neighborhood vitality and a sense of community” as the services and programs offered at this community center will greatly benefit the very residents in which it serves.

Albuquerque/Bernalillo County Comprehensive Plan – Education “The availability of educational opportunities and the location of the facilities which provide them are major contributors to building a good city. Opportunity to lead a good life depends on access to education, educational opportunity, in turn, is the foundation for life-long learning.

This community center project will provide a multitude of learning and educational opportunities for the residents of the South Valley. The very mission of the Catholic Charities is to provide the education programs and services that otherwise would not be offered to economically disadvantaged members of this community.

Albuquerque/Bernalillo County Comprehensive Plan – Human Services “The City Department of Family and Community Services provides support to the high priority human service needs for disadvantaged. The City also coordinates private and non-profit efforts to supply human services to qualifying residents and as liaison with outside organizations.”

Once again, this nonprofit organization is aligned with the goals and policies of the Comprehensive Plan to provide service needs to the disadvantaged in the heart of their community.

- (D) The applicant must demonstrate that the existing zoning is inappropriate: (3) a different use category is more advantageous to the community as articulated in the Comprehensive Plan or other City master plan, even though (1) or (2) above do not apply:**

The subject request meets all of the policies and criteria of R-270-1980, most notably: The requested O-1 zoning is more advantageous to the community as articulated in the Albuquerque/Bernalillo County Comprehensive Plan and the Southwest Area Plan as demonstrated above in the multitude of policies and goals furthered by this request.

- (E) A change of zone shall not be approved where some of the permissive uses in the zone would be harmful to adjacent property, the neighborhood or community.**

The establishment of O-1 zoning is appropriate because it is similar to surrounding zoning and will provide cohesive development and stability to the area. In addition,

the above-described parcels are contiguous to existing O-1 zoning development and the proposed uses are permissive in the O-1 zoning category. This project proposes no uses that are not permissive in the O-1 zone nor any that would be detrimental to the surrounding area or harmful to the community.

A proposed zone change which, to be utilized through land development, requires major and un-programmed capital expenditures by the City may be:

- a. **Denied due to lack of capital funds, or**
- b. **Granted with the implicit understanding that the City is not bound to provide the capital improvements on any special schedule.**

The subject site is serviceable with City utilities and services and vehicular access is provided on Bridge Boulevard. The development of the parcels will not require any capital improvements by the City. Development of this property will utilize extensions of the water and sanitary sewer services that originate on Bridge Blvd. and service the Bridge Campus adjacent to the east.

- (G) **The cost of land or other economic considerations pertaining to the applicant shall not be the determining factor for a change of zone.**

The cost of land or any other economic considerations are not a determining factor in this request. City O-1 zoning will promote commercial development with existing similarly commercially zoned property to the east and allow for the extension of a permissive use on the property furthering infill development and added services for the community.

- (H) **Location on a collector or major street is not in itself sufficient justification of apartment, office or commercial zoning.**

The roadway classification designation has no bearing in this request. The proposed location of the community center institution is based upon serving the needs of the community in which it is located.

- (I) **A zone change request which would give a zone different from surrounding zoning on one small area, especially when only one premise is involved, is generally called a "spot zone".**

This request will not create a spot zone as the property adjacent to the east is COA O-1 as well as several other properties.

A zone change request which would give a zone different from surrounding zoning to a strip of land along a street is generally called "strip zoning". Strip commercial zoning will be approved only where;

1. **the change will clearly facilitate realization of the Comprehensive Plan or any adopted sector development plan or area development plan.**

This request will not create a strip zone. The area surrounding the property to the east is zoned O-1.

The subject request meets all of the policies and criteria of R-270-1980, most notably: The requested O-1 zoning is more advantageous to the community as articulated in the Comprehensive Plan and the **Southwest Area Plan**.

The **Goal of the Semi-Urban Area** is to create a quality urban environment which perpetuates the tradition of identifiable, individual but integrated communities within the

metropolitan area and which offers variety and choice in housing, transportation, work areas, and lifestyles while creating a visually pleasing built environment.

New growth shall be accommodated through development in areas where vacant land is contiguous to existing urban facilities and services where the integrity of existing neighborhoods can be ensured (policy e).

Where new commercial development occurs, it should be located in existing commercially zoned areas. The adjacent property is currently zoned O-1 and is contiguous to several other parcels of developed property also zoned O-1

A Goal of the Southwest Area Plan is to encourage quality commercial/office/institutional development and redevelopment in response to area needs in already developed/established commercial zones and areas. The proposed zoning designation of O-1 is consistent with the current zoning and surrounding areas of developed commercial/Office/Institution use. The proposed lot will be developed as an expansion to an existing office/institution use.

The approval of this petition for annexation and a zoning designation of O-1 for the site will ensure cohesive development with the adjacent parcel and surrounding areas.

We respectfully request that the EPC support this important community development project for the Southwest Area of Albuquerque.

Sincerely,

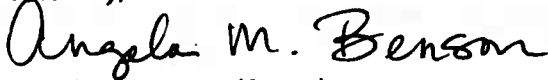

Angela M. Benson (Agent)

Vice President

DSA Architects, LLC

4700 Lincoln Road NE, Suite 111

Albuquerque, New Mexico

Office: (505) 342-6200

Email: angelab@dsaabq.com



Darren Sowell
ARCHITECTS



Darren Sowell
ARCHITECTS, LLC

August 25, 2014

City of Albuquerque
Environmental Planning Commission
Plaza del Sol, 600 Second NW
Albuquerque, NM 87102
Telephone: (505) 924-3860

Re: Catholic Charities - Annexation Petition and Zone Map Amendment Request for 2012 & 2034 Bridge Boulevard SW

Environmental Planning Commission:

This firm represents Catholic Charities, a New Mexico Nonprofit Corporation, in their effort to annex two parcels of land into the City of Albuquerque and establish City Zoning classification of O-1 (Office & Institutional) for the express purpose of expanding the Catholic Charities Bridge Street Campus, which is currently located adjacent to these parcels at 2010 Bridge Blvd. SW.

The approval of this annexation and zoning request would allow the applicant to expand existing services and embark on its greatest endeavor to date – the construction of Catholic Charities' community service center known as *Casa de Corazon*. This project, in the heart of Albuquerque's South Valley, will allow Catholic Charities to create a single campus where essential services and programs will be available to individuals who seek assistance.

Catholic Charities owns both proposed parcels of land, which are directly adjacent to the current Bridge Street Campus. The applicant would like to combine their current property at 2010 Bridge with the two additional parcels to expand the Bridge Street Campus as noted above, which is a permissive use in O-1 (office & institution) zoning. Included with this request are the architectural renderings and conceptual site plan that depict the desired result of the project. The two additional parcels will be utilized to expand parking and add a two-story building with outdoor play areas.

In September 2013, the Board of County Commissioners approved the application for annexation into the City of Albuquerque. The 1.37 acre parcel was found to have no adverse impacts to the provision of County services or the surrounding lands.

Catholic Charities is in the final planning and fundraising phase of this project. It is anticipated that construction for this project will begin mid 2015.

We respectfully request a recommendation of approval for the Annexation petition and Zone Map Amendment into the City of Albuquerque. If you have any questions regarding the Catholic Charities Bridge Street Campus Expansion, I can be reach at the information below.

Respectfully Submitted,

Angela M. Benson

Angela Benson, Vice President (Agent)
DSA Architects, LLC.
4700 Lincoln Road NE, Suite 111
Albuquerque, NM. 87109
(505) 342-6200
angelab@dsaabq.com

DSIA

Darren Sowell
ARCHITECTS



VIEW FROM THE NORTHWEST
CATHOLIC CHARITIES / ARCHDIOCESE OF SANTA FE - NEW CAMPUS

07-27-2012

Architecture
Interiors
Planning
Sustainable Design

Van H. Gilbert Architect PC

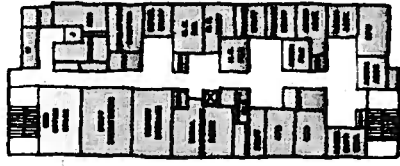

PROJECT
CATHOLIC CHARITIES
ARCHDIOCESE OF
SANTA FE - NEW
CAMPUS

2010 BRIDGE BLVD SW
ALBUQUERQUE NM,
87105

Van H. Gilbert Architect PC

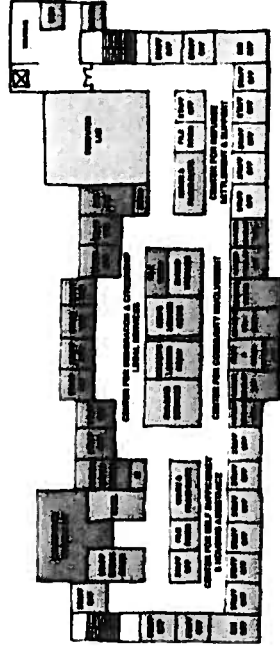

SECOND FLOOR PLAN
CATHOLIC CHARITIES / ARCHDIOCESE OF SANTA FE - NEW CAMPUS
SCALE 1/8" = 1'-0"

Van H. Gilbert Architect PC

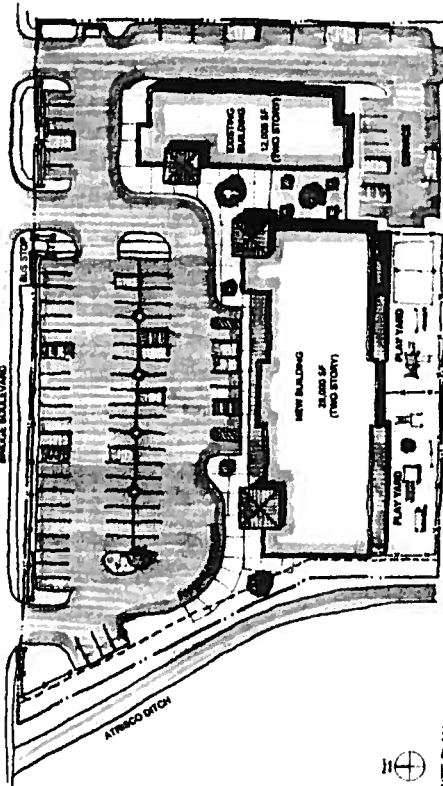

SITE PLAN
CATHOLIC CHARITIES / ARCHDIOCESE OF SANTA FE - NEW CAMPUS
SCALE 1/8" = 1'-0"

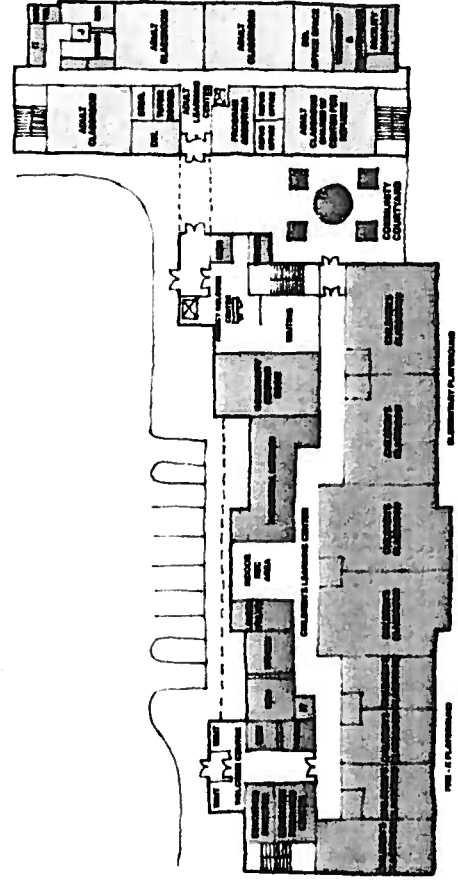

FIRST FLOOR PLAN
CATHOLIC CHARITIES / ARCHDIOCESE OF SANTA FE - NEW CAMPUS
SCALE 1/8" = 1'-0"

Van H. Gilbert Architect PC

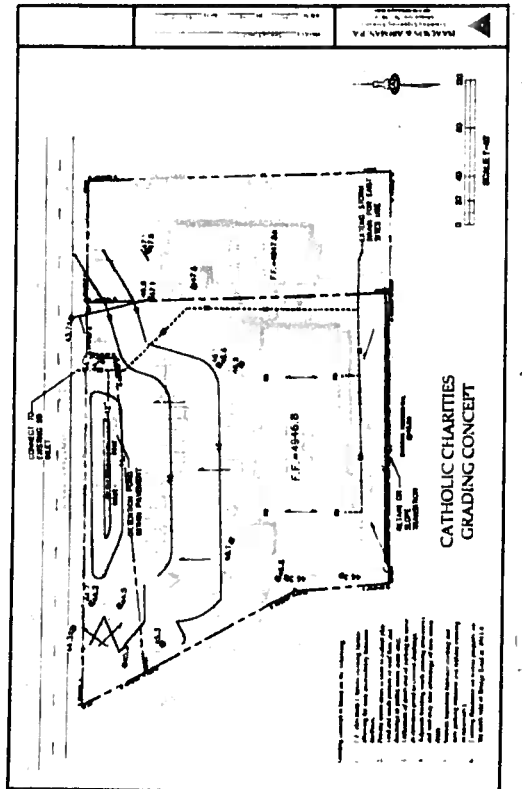

CATHOLIC CHARITIES
GRADING CONCEPT

1. ALL GRADING SHALL BE IN ACCORDANCE WITH THE CITY OF ALBUQUERQUE GRADING REGULATIONS.
2. ALL GRADING SHALL BE IN ACCORDANCE WITH THE STATE OF NEW MEXICO GRADING REGULATIONS.
3. ALL GRADING SHALL BE IN ACCORDANCE WITH THE FEDERAL GRADING REGULATIONS.
4. ALL GRADING SHALL BE IN ACCORDANCE WITH THE LOCAL GRADING REGULATIONS.
5. ALL GRADING SHALL BE IN ACCORDANCE WITH THE NATIONAL GRADING REGULATIONS.

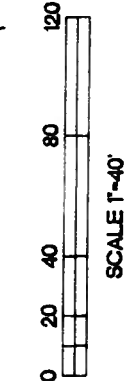
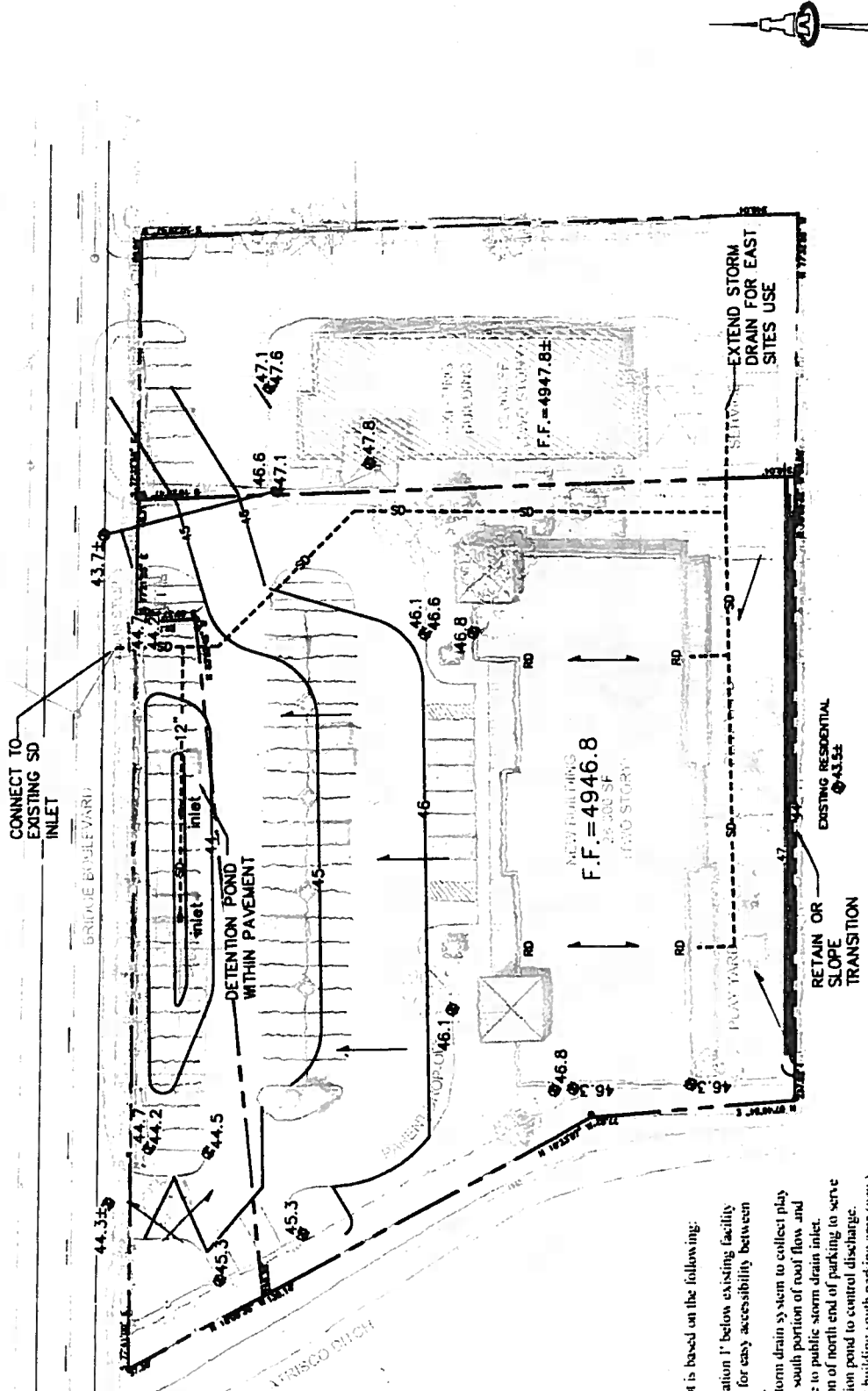

CATHOLIC CHARITIES GRADING CONCEPT

Grading concept is based on the following:

1. F.F. elevation 1' below existing facility allowing for easy accessibility between facilities.
2. Private storm drain system to collect play yard and south portion of roof flow and discharge to public storm drain inlet.
3. Utilization of north end of parking to serve as detention pond to control discharge.
4. Adjacent building south parking area (new) and roof may take advantage of new storm drain.
5. Smooth transition between existing and new parking (remove and replace existing as necessary).
6. Existing floodzone on within property on the north side of Bridge Road at 4943.0.

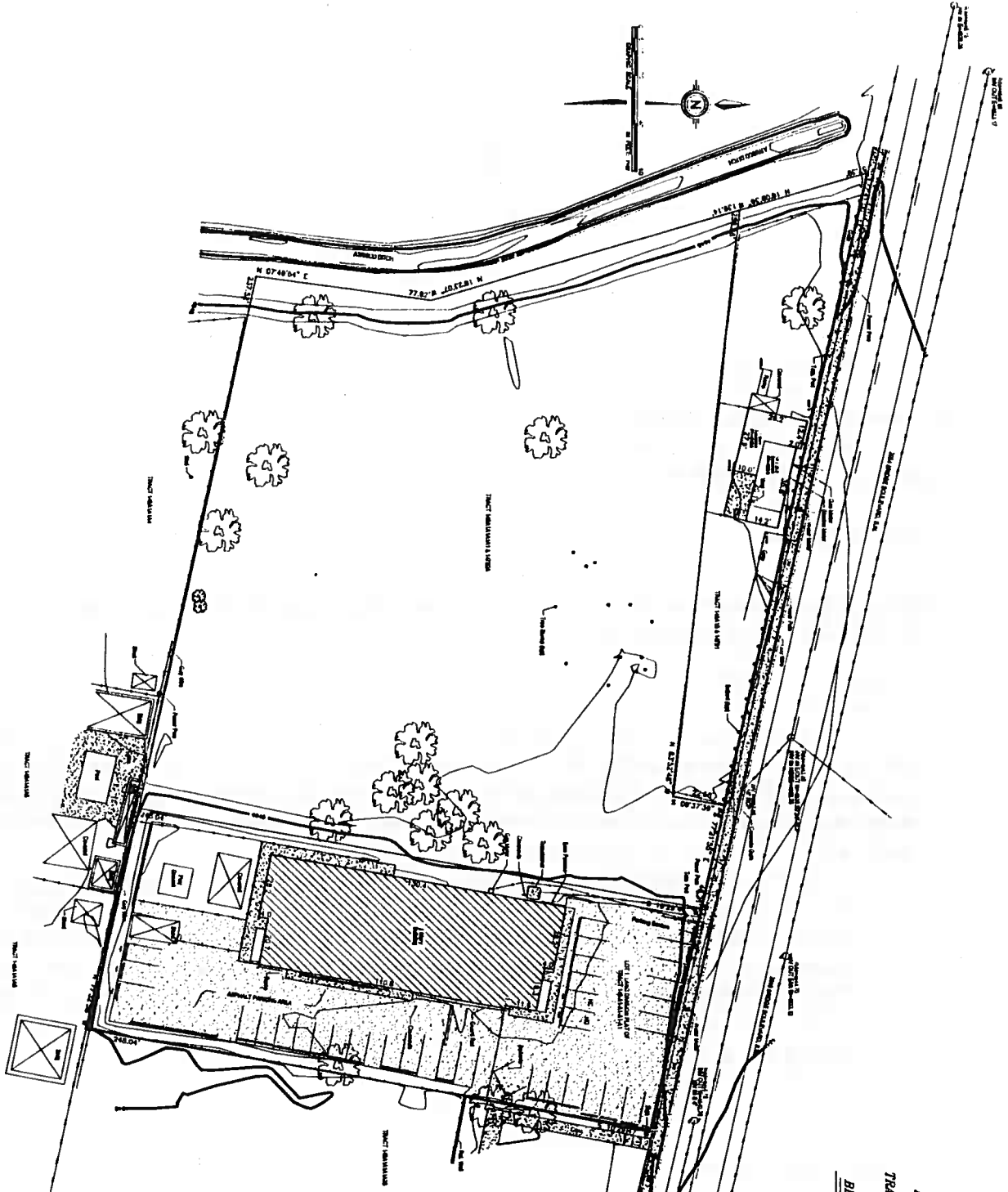

TOPOGRAPHIC SURVEY
 LOT 1, LAND DIVISION PLAT OF
 TRACT 148-A1-A1-A1-A1
 TRACT 148A1A1A1 & TRACT 147B2A
 TRACT 148A1B & TRACT 147B1
 M.R.C.D. MAP NO. 43
 BERNALILLO COUNTY, NEW MEXICO
 JANUARY 2012

- NOTES**
- 1) BENCH MARK IS ACES STATION 11,112 ELEVATION 4849.251
 - 2) THIS IS NOT A BOUNDARY SURVEY. ADJACENT PROPERTY CORNERS ARE SHOWN FOR INFORMATION ONLY. BOUNDARY DATA SHOWN FROM PREVIOUS SURVEY METHODS.

- LEGEND**
- UNDEVELOPED TERRITORY EXISTING
 - WATER
 - DRY
 - OVERHEAD POWER EXISTING
 - CONCRETE
 - CONCRETE SLAB EXISTING
 - STEEL DECK EXISTING
 - WOOD GROUND POWER EXISTING

PROFESSIONAL CERTIFICATION
 I, SANDIA LAND SURVEYING, A PROFESSIONAL CORPORATION, HAVE MADE A CAREFUL AND THOROUGH REVISION OF THE SURVEY AND THE RESULTS THEREOF AS SHOWN ON THIS PLAN. I HEREBY CERTIFY THAT THE SAME IS A TRUE AND CORRECT REPRESENTATION OF THE SURVEY MADE BY ME OR UNDER MY CLOSE PERSONAL SUPERVISION AND IN ACCORDANCE WITH THE PROVISIONS OF THE PROFESSIONAL LAND SURVEYING ACT, CHAPTER 58, ARTICLES 1, 2 AND 3, AND THE RULES AND REGULATIONS OF THE BOARD OF LAND SURVEYING, NEW MEXICO.

DATE: 1-26-2012
 SIGNATURE: [Signature]

SANDIA LAND SURVEYING
 A PROFESSIONAL CORPORATION
 STATE OF NEW MEXICO
 NO. 12345
 010-12
 1-2012
 A.S.M.



Darren Sowell

ARCHITECTS

www.dsaabq.com

505.342.6200

City of Albuquerque
Environmental Planning Commission
Plaza del Sol, 600 Second NW
Albuquerque, New Mexico 87102
Telephone: (505) 924-3860

August 25, 2014

Catholic Charities - Annexation Petition and Zone Map Amendment Request, In Accordance with Resolution 54-1990

Section 1. *Areas which are designated by the Albuquerque/Bernalillo County Comprehensive Plan as Central Urban, Established Urban and Developing Urban are particularly appropriate for the range of urban services which the City can provide, and annexation of such areas into the City is desired and encouraged. More specifically, annexation of areas planned to have urban intensity development will be approved when the following policies are met, unless the City concludes that the anticipated delay in provision of City services is so far into the future as to be speculative and therefore an unreasonable basis to provide for annexation:*

- a. Compliance with City policy regarding land dedication for public facilities is assured;*
- b. The applicant shall agree in writing to timing of capital expenditures for necessary major streets, water, sanitary sewer, and storm-water-handling facilities: **This project is an expansion to an existing facility in the City limits which is served by City streets, transit, sanitary sewer and storm water facilities. All utilities are in place and are of sufficient capacity for this development. There will be no expenditures to be incurred by the City of Albuquerque for this project.***

- (1) The timing to be per a written City statement of intent as to when it or another public body will be able to provide such capital facilities, such City statement to be issued prior to annexation; and/or

There will be no expenditures to be incurred by the City of Albuquerque for this project.

- (2) *The timing to remain indefinite but a substantial number of years in the future, based on a written City statement, made prior to annexation, that it will provide the facilities but no timing can be assured; and/or*

(3)

There will be no expenditures to be incurred by the City of Albuquerque for this project.

- (3) *A commitment by the land owner that he or his successors in interest will, in a manner that City standards, install and pay for such facilities or cause them to be installed and paid.*

*c. The City may decline an annexation if necessary capital expenditures fall all or partly under paragraph b(2), above, and the City concludes that it would be unreasonable to make land owners wait for basic utilities and facilities as long as would probably be the case; **There will be no expenditures to be incurred by the City of Albuquerque for this project.***

d. Land annexed shall be to some extent contiguous to the City limits, except land owned by the City may be annexed when it is not contiguous where this is allowed by state statutes; **The parcels requested for annexation are immediately adjacent (contiguous) to developed property in the City limits.**

e. Land to be annexed shall have provision for convenient street access to the City; **The land to be annexed has sufficient ingress/egress to Bridge Boulevard. This property has approximately 320 ft. of linear frontage for vehicle, pedestrian and transit traffic.**

f. Land to be annexed shall have reasonable boundaries so that providers of public services can determine with ease where the City boundary is located and so that public services can be delivered under appropriate service extension policies at reasonable operating and capital cost to the City; **A site plan and grading & drainage plan have already been prepared, the City utilities have been located in Bridge Boulevard and will be easily brought to the property line for development. There are no additional utilities that need to be delivered, thus incurring no capital cost to the City.**

g. City boundaries shall be established along platted lines which will make definite what the city limits are; annexation plats need not meet all requirements of a subdivision plat as specified by the Subdivision Ordinance. See application material on page 10-10.

With the approval of this request for annexation, the applicant intends to replat the existing two parcels into one cohesive parcel with the existing facility that is located in the City. This will satisfy the requirement that definite lines demonstrating City jurisdiction and territory.

Section 2. Areas which are designated by the Albuquerque/Bernalillo County Comprehensive Plan as Reserve are appropriate for annexation if they meet the guidelines established in the Reserve Area section (II-B-2) of the Plan, so as to create high quality, mixed use, largely self-sufficient planned communities. More specifically, such areas will be approved when the following policies are met:

- a. The policies stated in the subsections of Section 1 above; and
- b. Applications are accompanied or preceded by satisfactory plans for each community proposed.

This project and parcels being requested for Annexation are not identified as being part of the "Reserve"

Section 3. Areas which are designated by the Albuquerque/Bernalillo County Comprehensive Plan as Semi-Urban and as Rural are appropriate for annexation where the policies of the Semi-Urban and Rural Areas sections of the Plan are furthered or where the general public welfare clearly is better served by annexation. Zoning appropriate for a low intensity area, as indicated by the Comprehensive Plan, will be assigned. More specifically, annexation in areas planned to be less than urban intensity of development will be approved when the following policies are met:

- a. The policies stated in the subsections of Section 1 above;

The property being requested for annexation is in the Semi-Urban area of the Comprehensive Plan. The proposed zoning of O-1 will respect the location, intensity and design of new development, existing neighborhood values, natural environmental conditions and carrying capacities, scenic resources and resources of other social, cultural, recreational concerns because it is compatible with the adjacent O-1 zoning and will not overburden the existing natural or built

environment. Furthermore, the proposed O-1 zoning for the parcel to be annexed is consistent with the O-1 zoning in place at the existing Bridge Campus site to the east and will allow for cohesive development. Further demonstrating the adherence to policies of the comprehensive plan in which the general public clearly is better served by this annexation. This proposed development is compatible with the existing commercial development contiguous to the east which includes an office building, post office, restaurant, banking institution and a multitude of retail shopping.

b. Since the eventual annexation of all these areas is unlikely, special care shall be taken to maintain reasonable, compact boundaries in these areas. To this end, the City will not annex such land unless it:

(1) has at least ten percent of its boundary contiguous to the City boundary; or
The parcels being requested are immediately adjacent to the existing city parcel and the existing facility that will be expanded by this approval. The entire length of the requested parcel is contiguous to the City boundary

(2) does not create an arm of the City's incorporate area which is at any point less than 1,000 feet wide.

This request does not create an arm of the City's area which is at any point less than 1,000 feet wide.

c. Barring exceptional conditions, the City will not annex land on one side of a public street without also annexing the land on the other side of the street; and

d. Land shall not be annexed unless appropriate City zone categories are available for regulation of development in accord with planned and appropriate land development patterns.

This request is appropriate for the request zoning designation of O-1 which is the City zoning of the parcel being expanded and adjacent to the parcels being requested. This will allow for the cohesive development of the existing use.

Section 4. Areas which are outside Bernalillo County may be appropriate for annexation when the following policies have been met:

a. The policies stated in the subsections of Section 1 and above;

b. The Environmental Planning Commission and the City Council find that the area to be annexed:

(1) is suitable for urban intensity land uses and is near areas in Bernalillo County which are designated urban by the Albuquerque/Bernalillo County Comprehensive Plan; or

(2) the land is a City-owned park or open space.

c. The long term benefits to the City from the proposed annexation are deemed to outweigh City costs; and

d. The subject property owner's reasons for desiring annexation demonstrate a net benefit to the City and to the public welfare if the annexation is approved.

Section 5. The City may annex land even though some or all of the above policies are not met where the Environmental Planning Commission and City Council find:

a. That there is a particular hazard to the health of persons, that such hazard would be removed or materially alleviated by the City upon annexation, and that no other adequate and timely remedy for the removal or material alleviation of such hazard is available; or

b. That City-owned land used for a public purpose is being annexed to better facilitate that use.

The approval of this petition for annexation and a zoning designation of O-1 for the site will ensure cohesive development with the adjacent parcel and surrounding areas.

We respectfully request that the EPC support this important community development project for the Southwest Area of Albuquerque.

Sincerely,

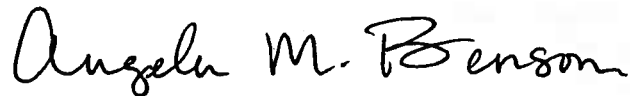

Angela M. Benson (Agent)
Vice President
DSA Architects, LLC
4700 Lincoln Road NE, Suite 111
Albuquerque, New Mexico
Office: (505) 342-6200
Email: angelab@dsaabq.com



Darren Sowell
ARCHITECTS



August 25, 2014

City of Albuquerque
Environmental Planning Commission
Plaza del Sol, 600 Second NW
Albuquerque, NM 87102
Telephone: (505) 924-3860

Re: Annexation Petition and Zone Map Amendment Request for 2012 & 2034 Bridge Boulevard SW

Environmental Planning Commission:

Catholic Charities, a New Mexico nonprofit corporation, hereby authorizes DSA Architects (Angela Benson) to act on our behalf in all matters relating to the annexation into the City of Albuquerque, of parcels of land adjacent to the Catholic Charities Bridge Street Campus, now located in the County of Bernalillo, including but not limited to signing of all documents related to annexation.

This authorization is valid until further written notice from Catholic Charities.

Sincerely,

A handwritten signature in black ink, appearing to read "Jim Gannon", is written over a horizontal line.

Jim Gannon
CEO/Executive Director

Administrative Offices
3301 Candelaria Rd. NE,
Suite B
Albuquerque, NM 87107
Ph: 505.724.4670
Fax: 505.254.2623

2010 Bridge SW
Albuquerque, NM 87105
Ph: 505.247.0442
Fax: 505.247.8335

4985 Airport Road
Santa Fe, NM 87507
Ph: 505.424.9789
Fax: 505.424.9792

www.ccasnm.org



CITY OF ALBUQUERQUE

TRAFFIC IMPACT STUDY (TIS) FORM

APPLICANT: Angela Benson (Agent) BSA Architects DATE OF REQUEST: 8-25-14 ZONE ATLAS PAGE(S): L-12

CURRENT: ZONING County CN-R-1 LEGAL DESCRIPTION: LOT OR TRACT # 148A1B BLOCK # _____
PARCEL SIZE (AC/SQ. FT.) _____ SUBDIVISION NAME _____

REQUESTED CITY ACTION(S): ANNEXATION SITE DEVELOPMENT PLAN: SUBDIVISION* AMENDMENT
ZONE CHANGE : From CN-R-1 To O-1 BUILDING PERMIT ACCESS PERMIT
SECTOR, AREA, FAC, COMP PLAN BUILDING PURPOSES OTHER
AMENDMENT (Map/Text) *includes platting actions

PROPOSED DEVELOPMENT: NO CONSTRUCTION/DEVELOPMENT GENERAL DESCRIPTION OF ACTION: # OF UNITS: 1
NEW CONSTRUCTION BUILDING SIZE: 28,000 (sq. ft.) OFFICE BLDG.
EXPANSION OF EXISTING DEVELOPMENT

Property Address → 2012 & 2034 Bridge Blvd. SW
Note: changes made to development proposals / assumptions, from the information provided above, will result in a new TIS determination.

Catholic Charities Foundation
APPLICANT OR REPRESENTATIVE Angela Benson (Agent) DATE 8-25-2014
(To be signed upon completion of processing by the Traffic Engineer)

Planning Department, Development & Building Services Division, Transportation Development Section - 2ND Floor West, 600 2ND St. NW, Plaza del Sol Building, City, 87102, phone 924-3994

TRAFFIC IMPACT STUDY (TIS) REQUIRED: YES NO BORDERLINE

THRESHOLDS MET? YES NO MITIGATING REASONS FOR NOT REQUIRING TIS: PREVIOUSLY STUDIED:
Notes: 28K OFFICE BLDG. < 51K TIS THRESHOLD FOR OFFICE

If a TIS is required: a scoping meeting (as outlined in the development process manual) must be held to define the level of analysis needed and the parameters of the study. Any subsequent changes to the development proposal identified above may require an update or new TIS.

Tony L... 8-25-14
TRAFFIC ENGINEER DATE

Required TIS must be completed prior to applying to the EPC and/or the DRB. Arrangements must be made prior to submittal if a variance to this procedure is requested and noted on this form, otherwise the application may not be accepted or deferred if the arrangements are not complied with.

TIS -SUBMITTED / / DATE _____
-FINALIZED / / TRAFFIC ENGINEER _____



County of Bernalillo
State of New Mexico

Rec'd -
Oct 1, 2013
MA

*Zoning, Building & Planning
Department*

*111 Union Square SE, Suite 100
Albuquerque, New Mexico 87102
Office: (505) 314-0350*

www.bernco.gov/zoning-building-and-planning/

NOTIFICATION OF DECISION
BOARD OF COUNTY COMMISSIONERS



September 27, 2013

COMMISSIONERS

Maggie Hart Stebbins, Chair
District 3

Debbie O'Malley, Vice Chair
District 1

Art De La Cruz, Member
District 2

Lonnie C. Talbert, Member
District 4

Wayne A. Johnson, Member
District 5

COUNTY MANAGER

Tom Zdunek

ELECTED OFFICIALS

Tanya R. Giddings
Assessor

Maggie Toulouse Oliver
Clerk

Willow Misty Parks
Probate Judge

Dan Houston
Sheriff

Manny Ortiz
Treasurer

Catholic Charities
6001 Marble Ave NE
Albuquerque, NM 87110

SUBJECT: FILE NO: AXBC-20130001

LEGAL DESCRIPTION: The County Planning Commission recommends approval of an annexation into the City of Albuquerque for MRGCD Tracts 148A1B, 147B1, 147B2A, and 148A1A1A1A1 located at 2012 and 2034 Bridge Blvd. SW on the south side of Bridge Boulevard between Anthony Lane and Pear Road, zoned C-N & R-1 with proposed City O-1 zone and containing approximately 1.37 acres. (L-12) ((Original request submitted by Calvert Menicucci PC., agent for Catholic Charities)

ACTION: APPROVED AN ANNEXATION INTO THE CITY OF ALBUQUERQUE

To Whom It May Concern:

At the September 24, 2013 public hearing, the Board of County Commission approved a request for annexation into the City of Albuquerque for MRGCD Tracts 148A1B, 147B1, 147B2A, and 148A1A1A1A1 located at 2012 and 2034 Bridge Blvd. SW on the south side of Bridge Boulevard between Anthony Lane and Pear Road, zoned C-N & R-1 with proposed City O-1 zone and containing approximately 1.37 acres. The decision was based on the following Findings.

1. This is a request for annexation into the City of Albuquerque for MRGCD Tracts 148A1B, 147B1, 147B2A, and 148A1A1A1A1 located at 2012 and 2034 Bridge SW on the south side of Bridge Boulevard between Anthony Lane and Pear Road, zoned C-N & R-1 with proposed City O-1 zone and containing approximately 1.37 acres.
2. The property is located adjacent to properties within the jurisdiction of the City of Albuquerque.

3. This request is consistent with Resolution 2011-36 in that there will be no adverse impact on the provision of county services or on surrounding lands remaining under the jurisdiction of Bernalillo County for items such as drainage, access, or traffic generation.
4. This request is consistent with the health, safety and general welfare of the residents of Bernalillo County.

If you have any questions, please feel free to contact me directly at 314-0385.

Sincerely,

ENRICO GRADI

Enrico Gradi
Community Development Manager

EG/fs

cc: File

Kevin Grovet, Public Works
CPC Members
Rene Sedillo, Technology Manager
Michelle Gricius, AGIS
Jeff Senseney, Building Official
Mari Simbaña, Permit Manager
Geraldine Vermeire, Project Coordinator
Calvert Menicucci PC, 8900 Washington Pl. NE, Albuquerque, NM 87113
Jim Gonnon, 3301 Candelario NE, Albuquerque, NM 87110
John Menicucci, 4333 Pan American Frwy. NE, Albuquerque, NM 87107



County of Bernalillo
State of New Mexico

*Zoning, Building & Planning
Department*

*111 Union Square SE, Suite 100
Albuquerque, New Mexico 87102
Office: (505) 314-0350*

www.bermco.gov/zoning-building-and-planning/

NOTIFICATION OF DECISION
COUNTY PLANNING COMMISSION



August 9, 2013

COMMISSIONERS

Maggie Hart Stebbins, Chair
District 3

Debbie O'Malley, Vice Chair
District 1

Art De La Cruz, Member
District 2

Lonnie C. Talbert, Member
District 4

Wayne A. Johnson, Member
District 5

COUNTY MANAGER

Tom Zdunek

ELECTED OFFICIALS

Tanya R. Giddings
Assessor

Maggie Toulouse Oliver
Clerk

Willow Misty Parks
Probate Judge

Don Houston
Sheriff

Manny Ortiz
Treasurer

Catholic Charities
6001 Marble Ave NE
Albuquerque, NM 87110

SUBJECT: FILE NO: AXBC-20130001

LEGAL DESCRIPTION: Calvert Menicucci PC., agent for Catholic Charities, requests annexation into the City of Albuquerque for MRGCD Tracts 148A1B, 147B1, 147B2A, and 148A1A1A1A1 located at 2012 and 2034 Bridge Blvd. SW on the south side of Bridge Boulevard between Anthony Lane and Pear Road, zoned C-N & R-1 with proposed City O-1 zone and containing approximately 1.37 acres. (L-12)

ACTION: RECOMMEND TO THE BOARD OF COUNTY COMMISSIONERS APPROVAL OF ANNEXATION INTO THE CITY OF ALBUQUERQUE

To Whom It May Concern:

At the August 7, 2013 public hearing, the County Planning Commission Recommended Approval of a request for annexation into the City of Albuquerque for MRGCD Tracts 148A1B, 147B1, 147B2A, and 148A1A1A1A1 located at 2012 and 2034 Bridge Blvd. SW on the south side of Bridge Boulevard between Anthony Lane and Pear Road, zoned C-N & R-1 with proposed City O-1 zone and containing approximately 1.37 acres. The decision was based on the following Findings.

1. This is a request for annexation into the City of Albuquerque for MRGCD Tracts 148A1B, 147B1, 147B2A, and 148A1A1A1A1 located at 2012 and 2034 Bridge SW on the south side of Bridge Boulevard between Anthony Lane and Pear Road, zoned C-N & R-1 with proposed City O-1 zone and containing approximately 1.37 acres.
2. The property is located adjacent to properties within the jurisdiction of the City of Albuquerque.

3. This request is consistent with Resolution 2011-36 in that there will be no adverse impact on the provision of county services or on surrounding lands remaining under the jurisdiction of Bernalillo County for items such as drainage, access, or traffic generation.
4. This request is consistent with the health, safety and general welfare of the residents of Bernalillo County.

If you wish to appeal this decision, you must do so by 12:00 noon on **August 26, 2013** in the manner described below. A filing fee of \$75.00 is required for properties consisting of one (1) acre or less, and \$100.00 is required for all others.

APPEALS: Appeal of any denial or approval of an application by the County Planning Commission may be submitted in writing to the office of the Zoning Director within 15 days after the date of the notice of decision by the County Planning Commission.

The date of the notice of decision in question shall not be included in the 15-day period for filing an appeal, and if the fifteenth day falls on a Saturday, Sunday or holiday, the next working day shall be considered as the deadline for filing the appeal.

A building permit or Certificate of Occupancy & Compliance shall not be issued until any appeal is decided, or the time for filing such appeal has expired.

WRITTEN NOTICE OF APPEAL SHALL BE FILED WITH THE ZONING DIRECTOR ON THE PRESCRIBED FORM ALONG WITH PAYMENT OF THE REQUIRED FILING FEE.

If you have any questions, please feel free to contact me directly at 314-0385.

Sincerely,

ENRICO GRADI

Enrico Gradi
Community Development Manager

EG/fs

cc: File

Kevin Grovet, Public Works
Calvert Menicucci PC, 8900 Washington Pl. NE, Albuquerque, NM 87113
Jim Gonnon, 3301 Candelario NE, Albuquerque, NM 87110
John Menicucci, 4333 Pan American Frwy. NE, Albuquerque, NM 87107



DEVELOPER INQUIRY SHEET

To obtain NA/HOA Contact Information for Application Submittal to the Planning Department.

The Office of Neighborhood Coordination (ONC) located in Room 120 (basement) of the Plaza Del Sol Building, 600 Second Street NW, Fax: (505) 924-3913 -OR- you can e-mail the Zone Map and Developer Inquiry Sheet to: Stephani Winklepleck, e-mail: swinklepleck@caba.gov. ONC will need the following information **BEFORE** NA/HOA Contact Information will be released to the Applicant/Agent on any Project being presented to the Planning Department. If you have any questions, please feel free to contact our office at (505) 924-3914.

Zone Map and this Developer Inquiry Sheet MUST be provided with request.
Please mark/hatch Zone Map where Property is located.

Your Developer Inquiry is for the following:

- Cell Tower Submittal: Free-Standing Tower -OR- Concealed Tower
 EPC Submittal DRB Submittal LUCS Submittal Liquor Submittal
 Administrative Amendments (AA's) Submittal City Project Submittal

CONTACT NAME: Angela Benson (Agent)
 COMPANY NAME: DSA Architects
 ADDRESS/ZIP: 4700 Lincoln Road
 PHONE: (505) 342-6200 FAX: 342-6201

LEGAL DESCRIPTION INFORMATION

LEGAL DESCRIPTION OF THE SUBJECT SITE FOR THIS PROJECT SUBMITTAL IS DESCRIBED BELOW (i.e., Lot A, Block A, of the For Your Information Subdivision):

Tracts 148A1B, 147B1, 147B2A and
148A1A1A1A1 located at 2012 and 2034
Bridge Blvd. SW.

LEGAL DESCRIPTION

LOCATED ON 2012 & 2034 Bridge Blvd SW
STREET NAME OR OTHER IDENTIFYING LANDMARK
 BETWEEN South Side of Bridge Between Pear AND
STREET NAME OR OTHER IDENTIFYING LANDMARK Road
STREET NAME OR OTHER IDENTIFYING LANDMARK

THE SITE IS LOCATED ON THE FOLLOWING ZONE ATLAS PAGE (L-12).

ONC/DevelopInquirySheet/siw (01/26/12)

Annexation and
Zone Map Amendment

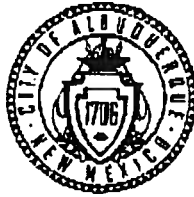

City of Albuquerque
P.O. Box 1293, Albuquerque, NM 87103

August 25, 2014

Angela Benson
DSA Architects
4700 Lincoln Rd.
Phone: 505-342-6200 Fax: 505-342-6201

Dear Angela:

Thank you for your inquiry of August 25, 2014 requesting the names of ALL Neighborhood and/or Homeowners Associations who would be affected under the provisions of O-92 by your proposed project at (EPC SUBMITTAL) TRACTS 148A1B, 147B1, 147B2A AND 148A1A1A1A1 LOCATED AT 2012 AND 2034 BRIDGE BOULEVARD SW. zone map L-12.

Our records indicate that the ALL Neighborhood and/or Homeowners Associations affected by this proposal and the contact names are as follows:

SEE ATTACHMENT "A" FOR THE NAMES OF THE NA/HOA'S THAT NEED TO BE CONTACTED IN REGARDS TO THIS PLANNING SUBMITTAL – please attach this letter and "Attachment A" to your Application Packet ALONG with copies of the letters and certified mail receipts to the NA/HOA's.

Please note that according to O-92 you are required to notify each of these contact persons by **certified mail, return receipt requested, before** the Planning Department will accept your application filing. **IMPORTANT! Failure of adequate notification may result in your Application Hearing being deferred for 30 days.** If you have any questions about the information provided, please contact me at (505) 924-3906 or via an e-mail message at dldcarmona@cabq.gov or by fax at (505) 924-3913.

Sincerely,

Dalaina Carmona

Senior Administrative Assistant
OFFICE OF NEIGHBORHOOD COORDINATION
Planning Department

PLEASE NOTE: The Neighborhood Association information listed in this letter is valid for one (1) month. If you haven't filed your application within one (1) month of the date of this letter - you will need to get an updated letter from our office. It is your responsibility to provide current information - outdated information may result in a deferral of your case.

LETTERS MUST BE SENT TO BOTH CONTACTS OF EACH NEIGHBORHOOD ASSOCIATION.

ATTACHMENT "A"

August 25, 2014

Angela Benson
 DSA Architects
 4700 Lincoln Rd.
 Phone: 505-342-6200 Fax: 505-342-6201

VECINOS DEL BOSQUE N.A. (VDB) "R"

***Rod Mahoney** e-mail: rmahoney01@comcast.net
 1838 Sadora Rd. SW/87105 681-3600 (c)
 Robert Sanchez
 631 Sunset SW/87105 242-7635 (h)
Website: www.vecinosdelbosque.org

Council District: 3&County
County District: 2
Police Beat: 118/SW
Zone Map: K-L-12-13

NEIGHBORHOOD COALITIONS

SOUTH VALLEY COALITION OF NEIGHBORHOOD ASSOCIATIONS

***Rod Mahoney**, 1838 Sadora Rd. SW/87105 681-3600 (c) e-mail: rmahoney01@comcast.net
 Marcia Fernandez, 2401 Violet SW/87105 877-9727 (h) e-mail: mbfernandez1@gmail.com
Website: www.svcna.org

SOUTH WEST ALLIANCE OF NEIGHBORS (SWAN)

***Johnny Pena**, 6525 Sunset Gardens SW/87121 321-3551 (c) 836-3281 (h)
 e-mail: johnnyepena@comcast.net
 Jerry Gallegos, 417 65th St. SW/87121 261-0878 (c) e-mail: jgallegos@vdmn.org

WESTSIDE COALITION OF N.A.'S

***Gerald C. (Jerry) Worrall**, 1039 Pinatubo Pl. NW/87120 839-0893 (h) 933-1919 (c)
 e-mail: jfworrall@comcast.net
 Harry Hendriksen, 10592 Rio Del Sole Ct. NW/87114-2701 890-3481 (h) 221-4003 (c)
 e-mail: hlhen@comcast.net

!!!Notice to Applicants!!!

SUGGESTED INFORMATION FOR NEIGHBORHOOD NOTIFICATION LETTERS

Applicants for Zone Change, Site Plan, Sector Development Plan approval or an amendment to a Sector Development Plan by the EPC, DRB, etc. are required under Council Bill O-92 to notify all affected recognized neighborhood associations **PRIOR TO FILING THE APPLICATION TO THE PLANNING DEPARTMENT.** Because the purpose of the notification is to ensure communication as a means of identifying and resolving problems early, it is essential that the notification be fully informative.

WE RECOMMEND THAT THE NOTIFICATION LETTER INCLUDE THE FOLLOWING INFORMATION:

1. The street address of the subject property.
2. The legal description of the property, including lot or tract number (if any), block number (if any), and name of the subdivision.
3. A physical description of the location, referenced to streets and existing land uses.
4. A complete description of the actions requested of the EPC:
 - a) If a **ZONE CHANGE OR ANNEXATION**, the name of the existing zone category and primary uses and the name of the proposed category and primary uses (i.e., "from the R-T Townhouse zone, to the C-2 Community Commercial zone").
 - b) If a **SITE DEVELOPMENT OR MASTER DEVELOPMENT PLAN** approval or amendment describe the physical nature of the proposal (i.e., "an amendment to the approved plan to allow a drive-through restaurant to be located just east of the main shopping center entrance off Montgomery Blvd.").
 - c) If a **SECTOR DEVELOPMENT PLAN OR PLAN AMENDMENT** a general description of the plan area, plan concept, the mix of zoning and land use categories proposed and description of major features such as location of significant shopping centers, employment centers, parks and other public facilities.
 - d) The name, address and telephone number of the applicant and of the agent (if any). In particular the name of an individual contact person will be helpful so that neighborhood associations may contact someone with questions or comments.

Information from the Office of Neighborhood Coordination

The following information should always be in each application packet that you submit for an EPC or DRB application. Listed below is a "Checklist" of the items needed.

~~One copy of the Council Resolution to the applicant (if there are associations). A copy must be submitted with application packet -OR-~~

[] The ONC "Official" Letter (if there are no associations). A copy must be submitted with application packet.

~~Two copies of letters to Neighborhood Associations (if there are associations). A copy must be submitted with application packet.~~

~~Two copies of the Council Resolution to Neighborhood Associations (if there are associations). A copy must be submitted with application packet.~~

Just a reminder - Our ONC "Official" Letter is only valid for a one (1) month period and if you haven't submitted your application by this date, you will need to get an updated letter from our office.

Any questions, please feel free to contact Dalaina at 924-3906 or via an e-mail message at dcarmona@cabq.gov.

Thank you for your cooperation on this matter.

.....
(below this line for ONC use only)

Date of Inquiry: 8/25/14 Time Entered: 3:45 p.m. ONC Rep. Initials: DC

CERTIFIED MAIL™ RECEIPT*(Domestic Mail Only; No Insurance Coverage Provided)*For delivery information visit our website at www.usps.com

ALBUQUERQUE NM 87105

Postage	\$ 0.49	0109
Certified Fee	\$3.30	
Return Receipt Fee (Endorsement Required)	\$2.70	
Restricted Delivery Fee (Endorsement Required)	\$0.00	
Total Postage & Fees	\$ 6.49	

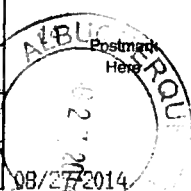

Sent To

Street, Apt. No., or PO Box No.

City, State, ZIP+4

PS Form 3800, August 2006

See Reverse for Instructions

U.S. Postal Service™ CERTIFIED MAIL™ RECEIPT*(Domestic Mail Only; No Insurance Coverage Provided)*For delivery information visit our website at www.usps.com

ALBUQUERQUE NM 87105

Postage	\$ 0.49	0109
Certified Fee	\$3.30	
Return Receipt Fee (Endorsement Required)	\$2.70	
Restricted Delivery Fee (Endorsement Required)	\$0.00	
Total Postage & Fees	\$ 6.49	

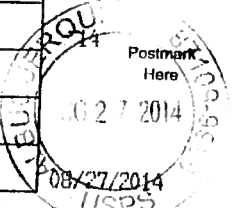

Sent To

Street, Apt. No., or PO Box No.

City, State, ZIP+4

PS Form 3800, August 2006

See Reverse for Instructions

U.S. Postal Service™ CERTIFIED MAIL™ RECEIPT*(Domestic Mail Only; No Insurance Coverage Provided)*For delivery information visit our website at www.usps.com

ALBUQUERQUE NM 87105

Postage	\$ 0.49	0109
Certified Fee	\$3.30	
Return Receipt Fee (Endorsement Required)	\$2.70	
Restricted Delivery Fee (Endorsement Required)	\$0.00	
Total Postage & Fees	\$ 6.49	

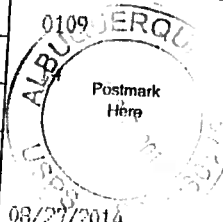

Sent To

Street, Apt. No., or PO Box No.

City, State, ZIP+4

PS Form 3800, August 2006

See Reverse for Instructions

CERTIFIED MAIL™ RECEIPT*(Domestic Mail Only; No Insurance Coverage Provided)*For delivery information visit our website at www.usps.com

ALBUQUERQUE NM 87114

Postage	\$ 0.49	0109
Certified Fee	\$3.30	
Return Receipt Fee (Endorsement Required)	\$2.70	
Restricted Delivery Fee (Endorsement Required)	\$0.00	
Total Postage & Fees	\$ 6.49	

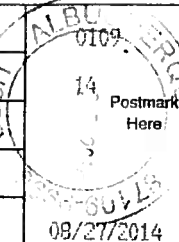

Sent To

Street, Apt. No., or PO Box No.

City, State, ZIP+4

PS Form 3800, August 2006

See Reverse for Instructions

U.S. Postal Service™ CERTIFIED MAIL™ RECEIPT*(Domestic Mail Only; No Insurance Coverage Provided)*For delivery information visit our website at www.usps.com

ALBUQUERQUE NM 87121

Postage	\$ 0.49	0109
Certified Fee	\$3.30	
Return Receipt Fee (Endorsement Required)	\$2.70	
Restricted Delivery Fee (Endorsement Required)	\$0.00	
Total Postage & Fees	\$ 6.49	

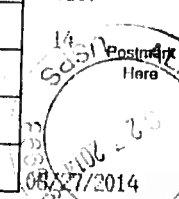

Sent To

Street, Apt. No., or PO Box No.

City, State, ZIP+4

PS Form 3800, August 2006

See Reverse for Instructions

U.S. Postal Service™ CERTIFIED MAIL™ RECEIPT*(Domestic Mail Only; No Insurance Coverage Provided)*For delivery information visit our website at www.usps.com

ALBUQUERQUE NM 87120

Postage	\$ 0.49	0109
Certified Fee	\$3.30	
Return Receipt Fee (Endorsement Required)	\$2.70	
Restricted Delivery Fee (Endorsement Required)	\$0.00	
Total Postage & Fees	\$ 6.49	

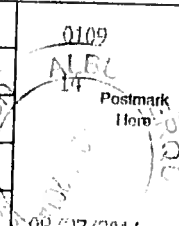

Sent To

Street, Apt. No., or PO Box No.

City, State, ZIP+4

PS Form 3800, August 2006

See Reverse for Instructions

7014 1200 0002 0262 8290

CERTIFIED MAIL™ RECEIPT
(Domestic Mail Only; No Insurance Coverage Provided)

For delivery information visit our website at www.usps.com

ALBUQUERQUE NM 87121

Postage	\$ 10.49	
Certified Fee	\$3.30	
Return Receipt Fee (Endorsement Required)	\$2.70	
Restricted Delivery Fee (Endorsement Required)	\$0.00	
Total Postage & Fees	\$ 16.49	

Sent To **Johnny Pena**
 Street, Apt. No., or PO Box No. **6325 Sunset Gardens**
 City, State, ZIP+4 **Albuquerque, NM, 87121**
 PS Form 3800, August 2006 See Reverse for Instructions

7014 1200 0002 0262 8306

CERTIFIED MAIL™ RECEIPT
(Domestic Mail Only; No Insurance Coverage Provided)

For delivery information visit our website at www.usps.com

ALBUQUERQUE NM 87105

Postage	\$ 10.49	
Certified Fee	\$3.30	
Return Receipt Fee (Endorsement Required)	\$2.70	
Restricted Delivery Fee (Endorsement Required)	\$0.00	
Total Postage & Fees	\$ 16.49	

Sent To **Red Mahoney**
 Street, Apt. No., or PO Box No. **1838 Sadora Rd.**
 City, State, ZIP+4 **Albuquerque, NM, 87105**
 PS Form 3800, August 2006 See Reverse for Instructions

August 25, 2014

Westside Coalition of N.A.'s
Attention: Harry Hendriksen
10592 Rio Del Sole Ct. NW
Albuquerque, NM. 87114

Re: NOTIFICATION - Catholic Charities Annexation Petition and Zone Map Amendment Request for 2012 & 2034 Bridge Boulevard SW

Westside Coalition of N.A.'s

This firm represents Catholic Charities, a New Mexico Nonprofit Corporation, in their effort to annex two parcels of land into the City of Albuquerque and establish City Zoning classification of O-1 (Office & Institutional) for the express purpose of expanding the Catholic Charities Bridge Street Campus, which is currently located adjacent to these parcels at 2010 Bridge Blvd. SW.

The approval of this annexation and zoning request would allow the applicant to expand existing services and embark on its greatest endeavor to date – the construction of Catholic Charities' community service center known as *Casa de Corazon*. This project, in the heart of Albuquerque's South Valley, will allow Catholic Charities to create a single campus where essential services and programs will be available to individuals who seek assistance.

Catholic Charities owns both proposed parcels of land, which are directly adjacent to the current Bridge Street Campus. The applicant would like to combine their current property at 2010 Bridge with the two additional parcels to expand the Bridge Street Campus as noted above, which is a permissive use in O-1 (office & institution) zoning. Included with this request are the architectural renderings and conceptual site plan that depict the desired result of the project. The two additional parcels will be utilized to expand parking and add a two-story building with outdoor play areas.

In September 2013, the Board of County Commissioners approved the application for annexation into the City of Albuquerque. The 1.37 acre parcel was found to have no adverse impacts to the provision of County services or the surrounding lands.

We respectfully request a recommendation of approval for the Annexation petition and Zone Map Amendment into the City of Albuquerque. If you have any questions regarding the Catholic Charities Bridge Street Campus Expansion, I can be reach at the information below.

Respectfully Submitted

Angela Benson, Vice President (Agent)
DSA Architects, LLC.
4700 Lincoln Road NE, Suite 111
Albuquerque, NM. 87109
(505) 342-6200
angelab@dsaabq.com

