











LEGEND:

-  The beginning or end of a process
-  An activity or task
-  Decision
-  An alternate process, not shown in detail on this process map
-  Document or Documents
-  Connection to another part of the map or another process map

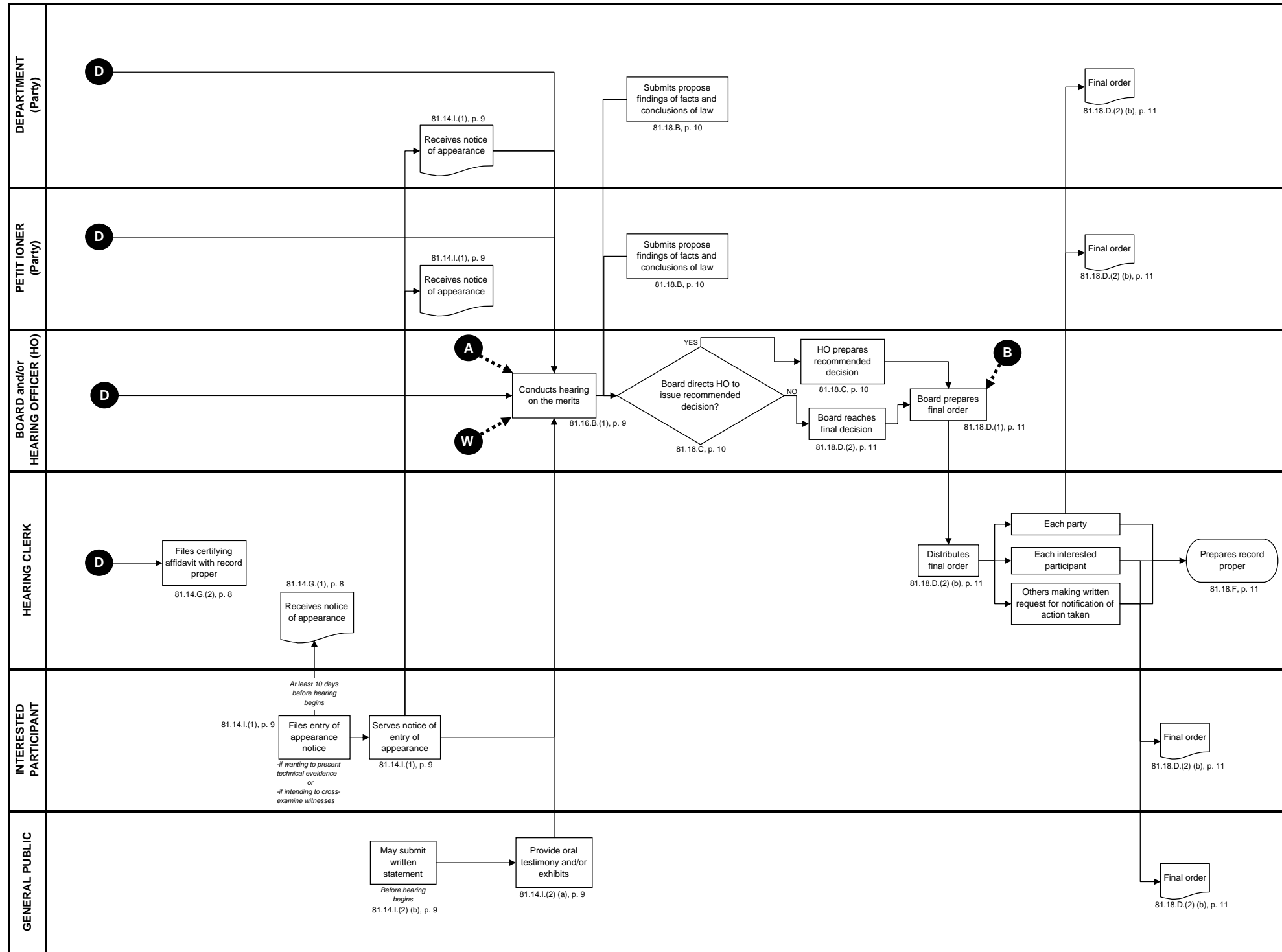
Part 81 Adjudication Process

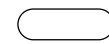

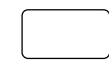
LEGEND:

-  The beginning or end of a process
-  An activity or task
-  Decision
-  An alternate process, not shown in detail on this process map
-  Document or Documents
-  Connection to another part of the map or another process map

**MOTIONS**  
Supplement to Adjudication Process

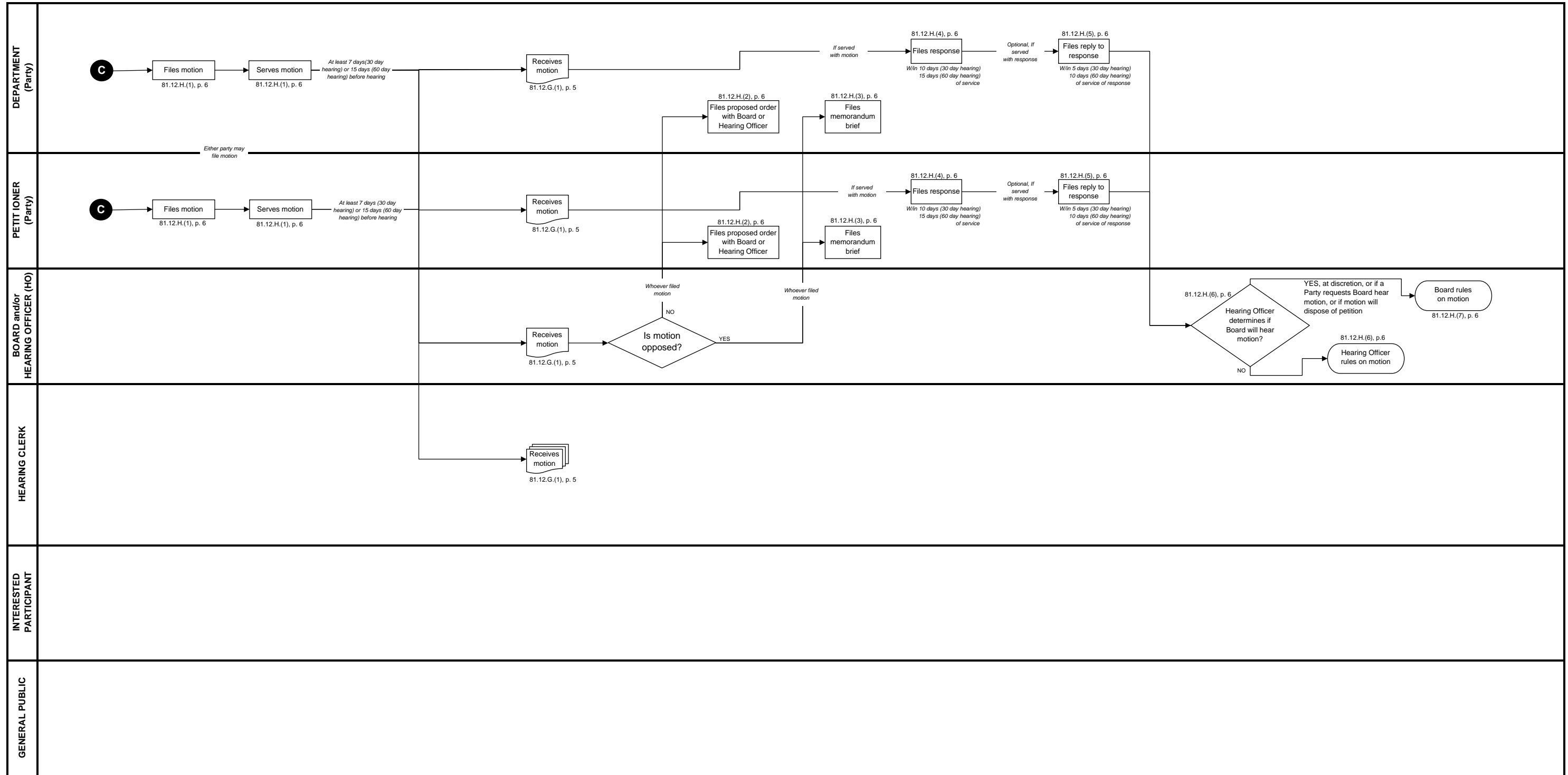

**ALTERNATE RESOLUTION**  
Supplement to Adjudication Process

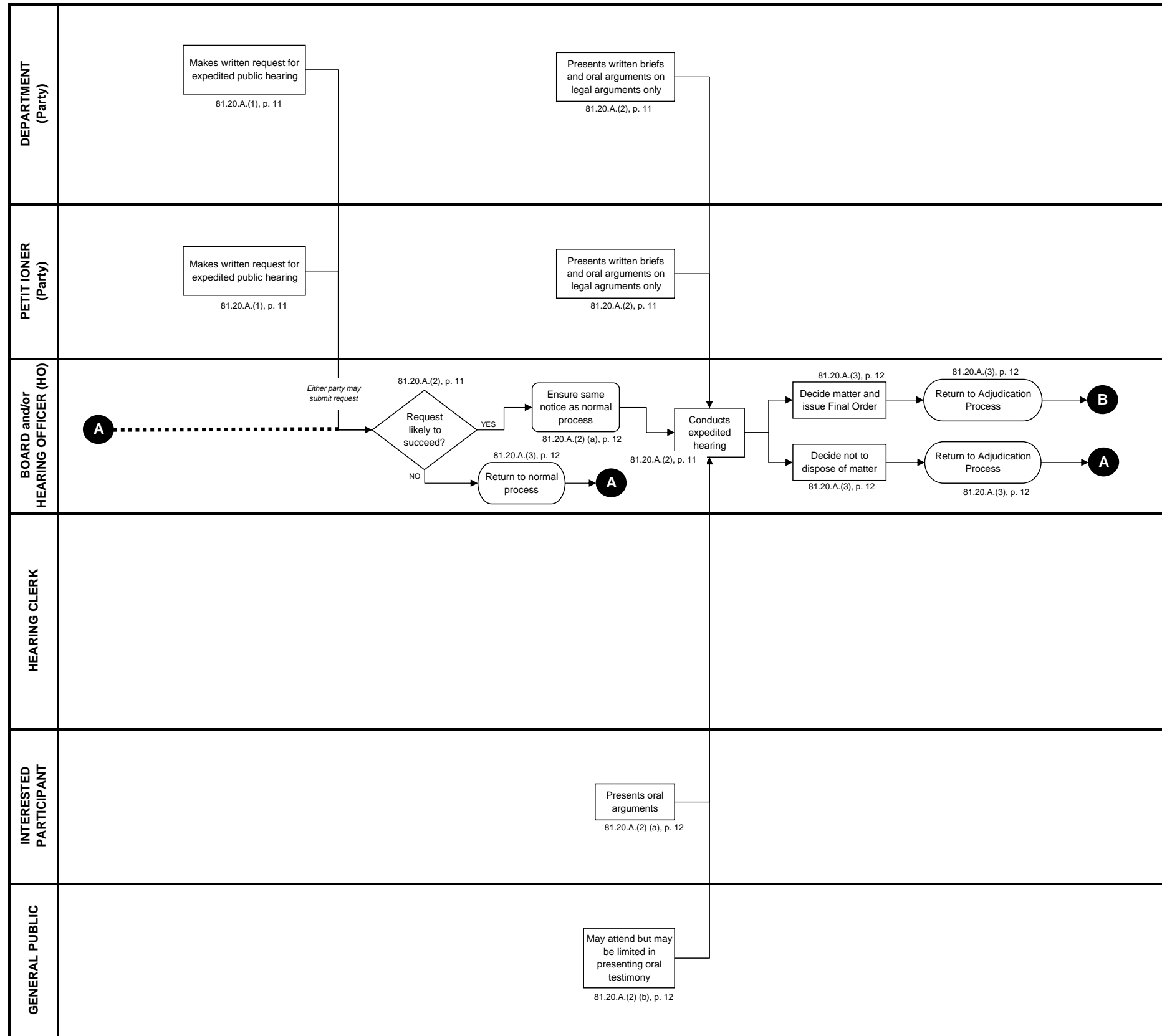

## WITHDRAWAL

Supplement to Adjudication Process

