



VOLCANO HEIGHTS

Sector Development Plan



AMENDED
November 5, 2014

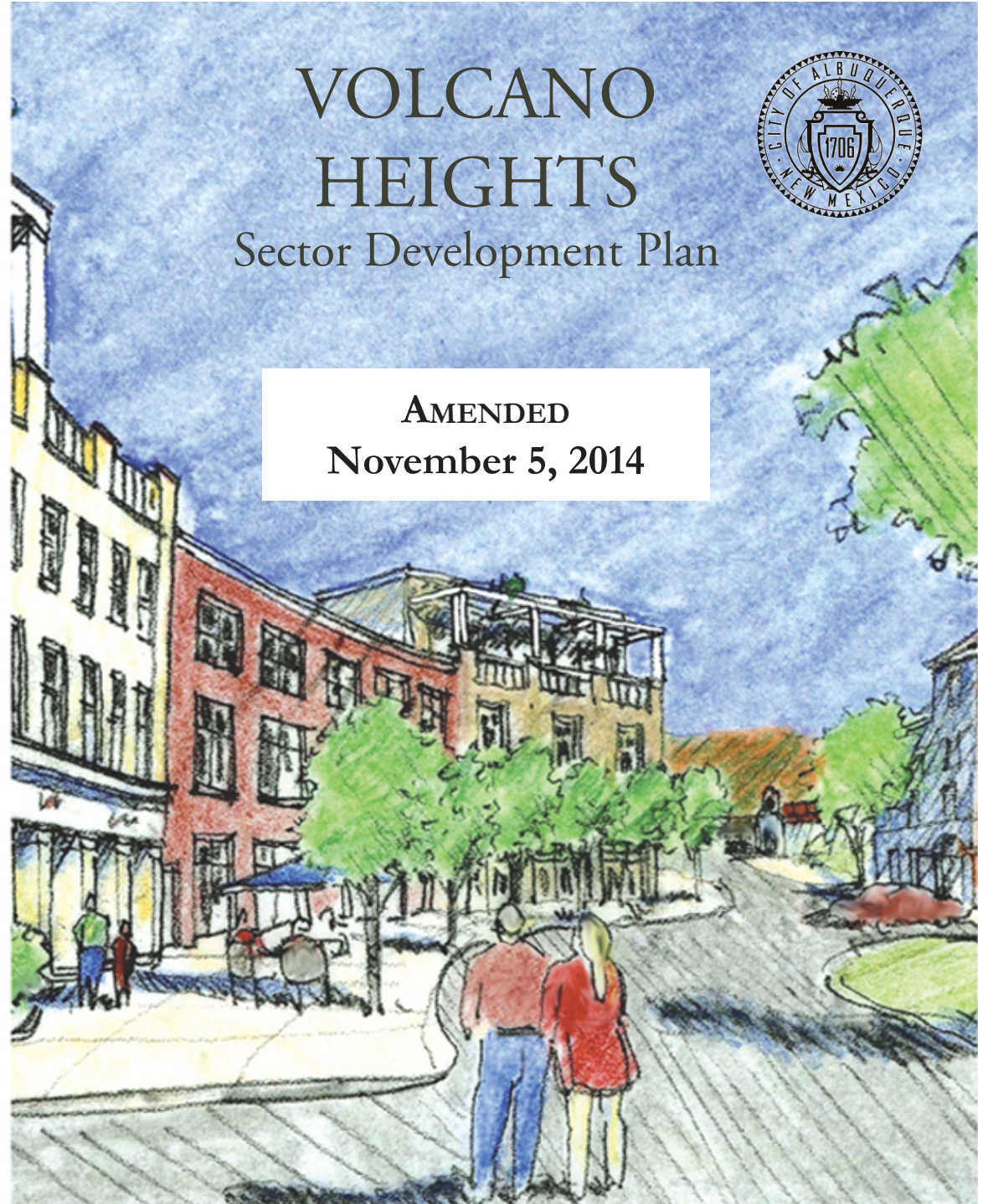

VOLCANO HEIGHTS SECTOR DEVELOPMENT PLAN

City of Albuquerque

Richard J. Berry, Mayor
Robert J. Perry, Chief Administrative Officer

City Council

Ken Sanchez, District 1, Vice President
Roxanna Meyers, District 2
Isaac Benton, District 3
Brad Winter, District 4
Dan Lewis, District 5, President
Rey Garduño, District 6
Janice E. Arnold-Jones, District 7
Trudy E. Jones, District 8
Don Harris, District 9

Environmental Planning Commission

Ron O. Garcia, Council District 1
Vacant, Council District 2
Moises Gonzalez, Council District 3
Peter Nicholls, Council District 4
Hugh Floyd, Chair, Council District 5
Maia Mullen, Council District 6
James Peck, Council District 7
Doug Peterson, Vice Chair, Council District 8
Michael Dickson, Council District 9

Special Thanks to:

Kurt Anschuetz, Rick Beltramo, Ron Bohannon, John Edward, Will Gleason, Dr. Gerald Gold, James Hoffman, Rene Horvath, John Ransom, Richard Ransom, Keith Sheffler, Jerold Widdison, Jolene Wolfley, Steve Metro

City and Technical Staff

COUNCIL SERVICES:

Laura Mason, Director, Kara Shair-Rosenfield, Sara Mancini, and Andrew Webb, Policy Analysts

PLANNING DEPARTMENT:

Suzanne Lubar, Director; Russell Brito, Manager, Urban Design & Development Division; Petra Morris and Mikaela Renz-Whitmore, Long Range Planning; Tim Gaulden, AGIS; Curtis Cherne, Hydrology; Tony Loyd and Kristal Metro, Transportation Review

PARKS AND RECREATION:

Matthew Schmader, Superintendent, Jay Lee Evans, and Susannah Abbey, Open Space Division; Christina Sandoval, Carol Dumont, and James Lewis, Parks and Recreation

LEGAL:

Anita Miller, Kevin Curran, Jenica Jacobi, and Blake Whitcomb

ECONOMIC DEVELOPMENT:

John Garcia and Dierdre Firth

MUNICIPAL DEVELOPMENT:

Debbie Bauman and Willfred Gallegos

ABQ RIDE:

Lawrence Kline and Andrew de Garmo

MID-REGION COUNCIL OF GOVERNMENTS:

Thaddeus Lucero, Tony Sylvester, Terry Doyle, Dave Panella, Kendra Watkins, Aaron Sussman, Steve Montiel, Julie Luna, and Caeri Thomas, as well as members of the Transportation Coordinating Committee and Roadway Access Committee

ALBUQUERQUE-BERNALILLO COUNTY WATER UTILITY AUTHORITY:

Allan Porter and Frank Roth

ALBUQUERQUE METROPOLITAN AREA FLOOD CONTROL AUTHORITY:

Brad Bingham and Karen Stearns

NATIONAL PARK SERVICE:

Diane Souder

GATEWAY PLANNING GROUP:

Scott Polikov and Brad Lonberger

NELSON\NYGAARD:

Jeremy Nelson and Colin Burgett

VOLCANO HEIGHTS SECTOR DEVELOPMENT PLAN

Originally Adopted by the City Council and Signed by the Mayor in August 2013

File No. R-13-132 / City Enactment No. R-2013-068

EPC 1009414, 12EPC-40061

Amendments:

This Plan incorporates the City of Albuquerque amendments in the following referenced Resolutions, which are on file with the City Clerk's Office and can be viewed on the City Council's webpage at <https://cabq.legistar.com/Legislation.aspx>, or by Administrative Amendment via Notice of Decision on file in the Planning Department.

Adoption	Council Bill No.	City Enactment No.	Description <i>[include purpose, summary, and EPC Case number]</i>
October 6, 2014	R-14-72	R-2014-079	Update transportation network map and cross sections for consistency with all Volcano Mesa Plans, edit building frontage definition and calculation, address residential and mixed-use development to prevent fugitive dust, adjust garage design standards, and fix errata. [EPC 1009414, 13EPC-40161]

[**Note:** Amendments as of 2014 are reflected in the Plan text. For more information, search for the Council Bill No. in City Council's Legistar webpage.]

**CITY of ALBUQUERQUE
TWENTIETH COUNCIL**

COUNCIL BILL NO. F/S R-13-132

ENACTMENT NO.

R-2013-068

SPONSORED BY: Dan Lewis, by request

1 RESOLUTION

2 FOR AN AREA OF APPROXIMATELY 569.1 ACRES, BOUNDED GENERALLY
3 BY PASEO DEL NORTE AND EXISTING DEVELOPMENT TO THE NORTH,
4 UNIVERSE BLVD. TO THE WEST, VOLCANO CLIFFS AND PASEO DEL NORTE
5 TO THE SOUTH AND THE PETROGLYPH NATIONAL MONUMENT TO THE
6 EAST; ADOPTING THE VOLCANO HEIGHTS SECTOR DEVELOPMENT PLAN
7 AS A RANK THREE PLAN AND CHANGING ZONING FROM R-D, SU-1 FOR PRD
8 AND SU-1 FOR C-1 USES TO SU-2/VHTC (VOLCANO HEIGHTS TOWN
9 CENTER), SU-2/VHRC (VOLCANO HEIGHTS REGIONAL CENTER), SU-2/VHVC
10 (VOLCANO HEIGHTS VILLAGE CENTER), SU-2/VHMX (VOLCANO HEIGHTS
11 MIXED USE), SU-2/VHNT (VOLCANO HEIGHTS NEIGHBORHOOD TRANSITION)
12 AND SU-2/VHET (VOLCANO HEIGHTS ESCARPMENT TRANSITION).

13 WHEREAS, the City Council, the governing body of the City of
14 Albuquerque, has the authority to adopt and amend plans for the physical
15 development of areas within the planning and platting jurisdiction of the City
16 authorized by Statute, Section 3-19-1 et. Seq., NMSA 1978, and by its home rule
17 powers; and

18 WHEREAS, Volcano Heights' location at the intersection of two regional
19 transportation corridors represents a unique opportunity to address the
20 imbalance of jobs and housing on the City's West Side by enabling the
21 development of a mixed-use, urban, walkable and transit-friendly environment
22 that attracts employers and destination retail and provides higher-density
23 residential living options; and

24 WHEREAS, the Rank Two West Side Strategic Plan's 2011 Volcano Mesa
25 Amendment recommended the designation of a new Major Activity Center at
26 this location; and

1
2 WHEREAS, this plan's vision for a Major Activity Center would also benefit
3 the regional traffic network served by Paseo del Norte and Unser Blvd. by
4 bringing goods, services and employment opportunities closer to existing
5 predominately residential areas, reducing the number and length of trips on
6 already-congested roads, and helping to alleviate the need for commutes east
7 across the Rio Grande to existing job centers; and

8 WHEREAS, existing zoning would only allow low-density development,
9 similar to what is already found in abundance on the West Side; and

10 WHEREAS, the Volcano Heights Sector Development Plan (VHSDP),
11 attached hereto, provides a flexible, balanced approach to address the
12 challenge of multiple property owners and undeveloped land with tailored land-
13 use and transportation regulations that emphasize coordination across
14 property lines, along corridors, and over time; and

15 WHEREAS, the VHSDP represents years of coordination and compromise
16 between property owners, neighbors and other stakeholders regarding
17 predictability of development, compatibility with the natural environment, and
18 preservation of key features such as rock outcroppings, sensitive lands and
19 views; and

20 WHEREAS, the Plan's approach seeks a balance between regulation and
21 incentive to accomplish its vision and goals for high-quality development; and

22 WHEREAS, approval of the Volcano Heights Sector Development Plan
23 (VHSDP) is consistent with the applicable goals and policies of the
24 Albuquerque/Bernalillo County Comprehensive Plan, the West Side Strategic
25 Plan, the Facility Plan for Major Public Open Space, the Facility Plan: Electric
26 System Generation and Transmission, the Northwest Mesa Escarpment Plan,
27 the Comprehensive Zoning Code, and R-270-1980.

28 BE IT RESOLVED BY THE COUNCIL, THE GOVERNING BODY OF THE CITY OF
29 ALBUQUERQUE:

30 Section 1. The City Council adopts the following findings:

31 1. The proposed VHSDP area comprises 569.1 acres of land
32 surrounding the intersection of two significant regional roads, Unser Blvd.
33 and Paseo del Norte, and is bounded generally by existing development in

[+ Bracketed/Underscored Material +] - New
[- Bracketed/Strikethrough Material -] - Deletion

[+ Bracketed/Underscored Material +] - New
[- Bracketed/Strikethrough Material -] - Deletion

[+ Bracketed/Underscored Material +] - New
[- Bracketed/Strikethrough Material -] - Deletion

1 Paradise Hills and part of Paseo del Norte to the North, Universe Boulevard to
2 the west, the Volcano Cliffs Sector Plan area and part of Paseo del Norte to
3 the south, and the Petroglyph National Monument to the east.

4 2. The Plan area is primarily undeveloped except for the two regional
5 roads that traverse it. It is surrounded by existing residential subdivisions and
6 areas of platted land awaiting development. It is divided into approximately
7 100 properties ranging from 2.5 acres to 68 acres, which are owned by about
8 35 different property owners. Five property owners account for approximately
9 75% of the Plan area.

10 3. There are approximately 10 acres of basalt rock outcroppings
11 scattered throughout the Plan area, many of which have cultural, historical
12 and geological significance related to their spiritual use by the area's earliest
13 inhabitants. The Plan area also has significant views of the Sandia Mountains
14 to the east.

15 4. The Plan area currently contains the following zones: Residential
16 and Related Uses, Developing Area (R-D), SU-1 for Planned Residential
17 Development (PRD) and SU-1 for C-1 neighborhood commercial uses.

18 5. The majority of the VHSDP Area is within a part of the city
19 designated Developing or Established Urban by the Rank One
20 Albuquerque/Bernalillo County Comprehensive Plan (Comprehensive Plan).
21 The VHSDP implements and furthers the applicable Goals and Policies of the
22 Comprehensive Plan as follows:

23 A. The VHSDP's zoning and design standards will protect and
24 preserve open space areas, including the Escarpment, Petroglyph National
25 Monument, and basalt rock outcroppings. Community open areas that tie into
26 the open space network are encouraged through a combination of
27 regulations, standards, and incentives in the Plan, including, in particular, the
28 single-loaded Park Edge Road that serves as a buffer to the Petroglyph
29 National Monument and the bonus height criteria that incentivize protections
30 of the natural environment (II.B.1 Policies c, d, f, g, h, j).

31 B. The West Side Strategic Plan's Volcano Mesa community
32 and its Major Activity Center (MAC) designation and policies address the
33 existing conditions of the Volcano Heights Plan area to ensure compatibility

[+ Bracketed/Underscored Material +] - New
[- Bracketed/Strikethrough Material -] - Deletion

1 of development on vacant land with existing neighborhoods, urban services
2 and facilities, and natural features (II.B.5 Policies c, d, e, g, n).

3 C. Higher-density housing in the Volcano Heights MAC, with
4 access to Paseo del Norte and Unser Boulevard, is appropriate to support
5 employment and service uses. The MAC's development pattern, Transition
6 zones, and proposed densities along arterial and collector streets will protect
7 existing residential areas and views, minimize traffic, and enhance livability
8 via context sensitive design standards and a comprehensive network of
9 primary and secondary streets (II.B.5 Policies h, i, k, l, m).

10 D. The Volcano Heights MAC will provide a way to address the
11 jobs/housing imbalance in the area with new job opportunities, densities, and
12 structure sizes that are appropriate to and buffered from nearby low-density
13 residential areas via Transition zones (II.B.7 Policies c, e, f, and II.D.6 Policies
14 a and g).

15 E. More compact development, coupled with a multi-modal
16 transportation system, will improve air quality compared to what could be
17 developed under the pre-existing zoning (II.C.1 Policies b and d).

18 F. The VHSDP contains a combination of regulations and
19 incentives to protect, preserve, and enhance the area's unique archaeological
20 resources, including an incentive for interpretive signage to educate visitors
21 and residents about the area's history, culture, and geology (II.C.6 Policy c).

22 G. The VHSDP, particularly its zoning and design standards
23 that include native plant lists and streetscape standards, will lead to a quality
24 developed landscape that preserves and enhances the natural and built
25 environments. Building, streetscape, and site development standards will
26 ensure a quality developed landscape that preserves and enhances this
27 community's identity via a high-quality built environment that is in harmony
28 with the area's unique natural setting (II.C.8 Policies a, d, e, and II.C.9 Policies
29 b, c, e).

30 H. The VHSDP's incentives built into the height bonus system,
31 its multi-modal street network, and transit-supportive development pattern
32 promote energy efficiency, variety of transportation, and expansion of transit
33 corridors and service. The plan's multi-modal cross sections, comprehensive

[+ Bracketed/Underscored Material +] - New
[- Bracketed/Strikethrough Material -] - Deletion

1 network of primary and secondary streets, and transit corridor – coordinated
2 with ABQ Ride, the City’s Department of Municipal Development, and the Mid-
3 Region Council of Governments (MRCOG) – will serve existing and future
4 transportation needs for all users and, in conjunction with the compact
5 development pattern, reduce peak hour demands in the morning hours on
6 regional roads (II.D.3 Policies a and d, and II.D.4 Policies c, f, o).

7 6. The VHSDP implements and furthers the established goals and
8 policies of the Rank Two West Side Strategic Plan as follows:

9 A. The Plan’s proposed density, mixed-use development
10 pattern and scale, location at the intersection of major arterials, and multi-
11 modal street network create the appropriate conditions to support a Major
12 Activity Center on the West Side that provides opportunities for employment
13 to address the existing jobs/housing imbalance (Policies 1.1, 1.9, 1.18, 3.85,
14 3.95, 3.96).

15 B. The Plan’s implementation strategies encourage the
16 creation of Public Improvement Districts, Special Assessment Districts, and
17 public/private partnerships, as well as further collaboration with implementing
18 agencies such as Albuquerque/Bernalillo County Water Utility Authority,
19 Albuquerque Metropolitan Area Flood Control Authority, ABQ Ride, Mid-
20 Region Council of Governments, and City Department of Municipal
21 Development (Policy 3.98).

22 C. The Plan’s comprehensive street network, requirements for
23 usable and detached open space, and regulatory and incentive-based
24 protections for archaeological and geological resources, native plant lists,
25 grading and construction mitigation standards, and context-sensitive zoning
26 and design standards will work together to protect the area’s sensitive
27 resources and encourage development in harmony with the unique natural
28 setting (Policies 3.99, 3.100, 3.101, 3.103, 3.104, 3.105, 3.106, 3.107, 3.108).

29 D. Adequate access and transportation choices for all users
30 are supported by additional intersections along Paseo del Norte and Unser
31 Boulevard, proposed high-capacity transit corridor and transit-supportive
32 densities, land uses, and development patterns, and multi-modal cross
33 sections (Policies 3.110, 3.111, and 3.112).

[+ Bracketed/Underscored Material +] - New
[- Bracketed/Strikethrough Material -] - Deletion

1 7. The Plan implements the Rank Two Facility Plan for Major Public
2 Open Space as follows:

3 A. The Escarpment Transition zone limits building height,
4 scale, massing, building color, and density adjacent to the Petroglyph
5 National Monument to ensure compatible development. The transition zone
6 works with the proposed single-loaded Park Edge Road to protect visual
7 access and view corridors (Design Guidelines for Development Adjacent to
8 Major Public Open Space B.3.A and B.3.B; Resource Management C.6.E, West
9 Side Open Space, Section 4, Policy C.1).

10 B. Grading and construction mitigation regulations, the Park
11 Edge Road and associated bioswale/linear pond, and coordination with a
12 future drainage management plan by AMAFCA will protect the escarpment by
13 managing stormwater and controlling erosion (West Side Open Space,
14 Section 4, Policy D.1).

15 8. The Plan implements policies in the Rank Two Facility Plan:
16 Electric System Generation and Transmission (2010-2020) by limiting
17 electrical uses in the Escarpment and Neighborhood Transition zones to
18 ensure the appropriate siting of electrical facilities away from residential
19 areas, sensitive lands, and highly visible topographic areas (Standard III.A.1,
20 III.A.9, and III.A.10).

21 9. The Plan’s height limits, color restrictions, drainage and
22 construction mitigation regulations, reflectivity limits, Park Edge Road,
23 Escarpment Transition zone, bonus height system, and multi-modal street
24 network complement many policies of the Rank Three Northwest Mesa
25 Escarpment Plan (NWMEP) (9, 11, 12, 15, 19, 20, 21, 23, and 35).

26 10. The Plan’s sign standards are generally consistent with the
27 Unser Boulevard Design Overlay Zone (DOZ) and address the regulation of
28 signs in a more holistic and context sensitive way.

29 Section 2. The City Council makes the following findings, which are
30 supported by and further elucidated in the complete record, as to compliance
31 with R-270-1980 for the zone changes with respect to the VHSDP’s new zones:

32 1. With respect to Policy (A), the zoning established in the VHSDP is
33 consistent with the health, safety, morals, and general welfare of the city

[+ Bracketed/Underscored Material +] - New
[- Bracketed/Strikethrough Material -] - Deletion

1 because it helps ensure that future development within the Plan area furthers
 2 the goals and policies of the Comprehensive Plan and other applicable plans.
 3 Specifically, it provides opportunities for sustainable, mixed-use development
 4 and additional employment on the West Side that can help address the
 5 imbalance of jobs to housing that creates significant traffic congestion and
 6 negatively impacts quality of life for West Side residents.

7 2. With respect to Policy (B), the VHSDP’s zoning creates
 8 predictability for future development and, thus, brings stability to this largely
 9 undeveloped area. The new zoning established in this Plan is needed in order
 10 to implement established policies in the Rank One Comprehensive Plan, Rank
 11 Two West Side Strategic Plan, Rank Two Facility Plan for Major Public Open
 12 Space, and Rank Three Northwest Mesa Escarpment Plan that; existing
 13 zoning does not further adopted City policies and should, thus, be changed.

14 3. With respect to Policy (C), the VHSDP’s zoning poses no
 15 significant conflict with adopted elements of the Comprehensive Plan or other
 16 city master plans and amendments as outlined in Findings 5 through 9 in
 17 Section 1 of this Resolution.

18 4. With respect to Policy (D), the existing R-D zoning in the area is
 19 inappropriate and new zones are needed because community conditions have
 20 changed, including existing and anticipated traffic congestion and a
 21 preponderance of single-family residential uses without the balance of nearby
 22 employment opportunities. Furthermore, the new zones are more
 23 advantageous to the community, as articulated in the Comprehensive Plan
 24 and other adopted City plans as cited above, than existing zoning since they
 25 provide the opportunity for a range of uses, including employment, retail, and
 26 services, in close proximity to existing residential areas and future residents
 27 in the Plan area.

28 5. With respect to Policy (E), permissive uses in the VHSDP’s zones
 29 would not be harmful to adjacent property, the neighborhood, or the
 30 community because the mix of uses and the urban form resulting from the
 31 design standards create compatibility within the Plan area and with adjacent
 32 development. The Plan’s proposed development pattern of walkable and
 33 transit supportive retail, employment, and residential uses provides benefits

[+ Bracketed/Underscored Material +] - New
[- Bracketed/Strikethrough Material -] - Deletion

1 for existing and future residents. Additionally, permissive uses at the edges
 2 of the Plan area in the Transition zones are limited to those that are
 3 compatible with existing nearby development.

4 6. With respect to Policy (F), the establishment of new zones in the
 5 VHSDP does not require major and unprogrammed capital expenditures by
 6 the City. The plan suggests various strategies to finance infrastructure,
 7 including Public Improvement Districts (PIDs), Tax Increment Development
 8 Districts (TIDDs), or Special Assessment Districts (SADs), which all require
 9 property owners to collaborate, vote to institute the mechanism, and work
 10 with the City to implement the agreed-upon infrastructure improvements. The
 11 Plan also identifies potential priority capital improvement projects, such as
 12 the full build out of regionally-significant roadways, that are essential to
 13 implementing the development vision of the Plan, but the Plan in no way
 14 obligates the City to make or fund any capital improvements. Decisions about
 15 future City participation in the provision of infrastructure to support
 16 development in Volcano Heights should assess the potential return on
 17 investment of the improvements and take into consideration both the
 18 economic and community benefits that would result from creating an area
 19 well-served by infrastructure.

20 7. With respect to Policy (G), the cost of land or other economic
 21 considerations are not the determining factor for the zone changes. The most
 22 significant factor is that the changes are more advantageous to the
 23 community as articulated in adopted City plans.

24 8. With respect to Policy (H), the VHSDP does not use “location on a
 25 collector or major street” as the justification for establishing mixed-use
 26 zoning within the Plan area; rather the location of mixed-use and higher-
 27 density residential zoning is related to the vision proposed for the whole
 28 Volcano Mesa area.

29 9. With respect to Policy (I), the Plan does not establish spot zones;
 30 rather the Plan contains a rational nesting of zone categories, with the most
 31 dense and intense at the center, and least dense and intense at the borders
 32 where the boundaries abut existing single-family residential areas or the
 33 Petroglyph National Monument. Additionally, the Plan does not allow the use

[+ Bracketed/Underscored Material +] - New
[- Bracketed/Strikethrough Material -] - Deletion

1 of SU-1 Special Use zones, which are inherently spot zones and would
2 undermine the Plan's comprehensive, yet flexible, zoning strategy.
3 10. With respect to Policy (J), the Plan does not establish strip
4 zones; rather the Plan establishes zoning in accordance with a
5 comprehensive transportation network to allow the development of all
6 properties, create transitions between zones, and implement adopted City
7 policies.
8 Section 3. The Volcano Heights Sector Development Plan, attached hereto
9 and made a part hereof, is adopted as a Rank Three Plan with land use control
10 pursuant to the Comprehensive City Zoning Code and as a regulatory guide to
11 the implementation of the Rank One Albuquerque/Bernalillo County
12 Comprehensive Plan and applicable Rank Two and Three Plans as cited
13 above.
14 Section 4. All development activities within the Volcano Heights Sector
15 Development Plan boundaries shall be guided and regulated by the policies,
16 standards, and regulations of the VHSDP.
17 Section 5. The Zone Map, adopted by Article 14-16-4-9 ROA 1994, is hereby
18 amended to reflect the rezoning in the map contained in Chapter 2, Section 4
19 of the Volcano Heights Sector Development Plan.
20 Section 6. With respect to any overlap that exists between the Volcano
21 Heights Sector Development Plan and any other Rank Three Plan, where the
22 regulations conflict, the Volcano Heights Sector Development Plan shall
23 prevail.
24 Section 7. EFFECTIVE DATE. This resolution shall take effect five days
25 after publication by title and general summary.
26 Section 8. SEVERABILITY CLAUSE. If any section paragraph, sentence,
27 clause, word, or phrase of this resolution is for any reason held to be invalid
28 or unenforceable by any court of competent jurisdiction, such decision shall
29 not affect the validity of the remaining provisions of this resolution. The
30 Council hereby declares that it would have passed this resolution and each
31 section, paragraph, sentence, clause, word or phrase thereof irrespective of
32 any provisions being declared unconstitutional or otherwise invalid.
33

[+ Bracketed/Underscored Material +] - New
[- Bracketed/Strikethrough Material -] - Deletion

1
2
3
4
5
6
7
8
9
10
11
12
13
14
15
16
17
18
19
20
21
22
23
24
25
26
27
28
29
30
31
32
33
34
35

1 PASSED AND ADOPTED THIS 5th DAY OF August 2013
2 BY A VOTE OF: 9 FOR 0 AGAINST.

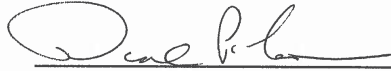
3
4
5
6 

7
8 Daniel P. Lewis, President
9 City Council

10
11
12
13 APPROVED THIS 28th DAY OF August, 2013

14
15
16
17 Bill No. F/S R-13-132

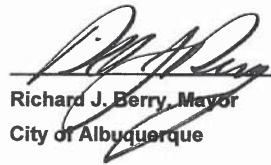
18
19 
20
21 Richard J. Berry, Mayor
22 City of Albuquerque

23
24
25
26 ATTEST:

27 
28
29 Amy B. Bailey, City Clerk

30
31
32
33

[+ Bracketed/Underscored Material +] - New
[- Bracketed/Strikethrough Material -] - Deletion

CITY of ALBUQUERQUE
TWENTY-FIRST COUNCIL

COUNCIL BILL NO. R-14-72 ENACTMENT NO. R-2014-079

SPONSORED BY: Dan Lewis, by request

1 RESOLUTION

2 AMENDING THE VOLCANO HEIGHTS SECTOR DEVELOPMENT PLAN TO
3 UPDATE THE ROAD NETWORK, RECONCILE AMENDMENTS MADE TO
4 ADJACENT PLANS, AND MAKE MINOR CLARIFICATIONS TO DEVELOPMENT
5 STANDARDS.

6 WHEREAS, the City Council, the governing body of the City of
7 Albuquerque, has the authority to adopt and amend plans for the physical
8 development of areas within the planning and platting jurisdiction of the City
9 authorized by Statute, Section 3-19-1 et. Seq., NMSA 1978, and by its home
10 rule powers; and

11 WHEREAS, The City Council adopted the Volcano Heights Sector
12 Development Plan in August 2013, for an area of approximately 569 acres,
13 bounded generally by Paseo del Norte and existing development to the north,
14 Universe Boulevard to the west, Volcano Cliffs to the south, and the
15 Petroglyph National Monument to the east; and

16 WHEREAS, this Plan seeks to capitalize on Volcano Heights' location at the
17 intersection of two regional transportation corridors, which represents a
18 unique opportunity to address the imbalance of jobs and housing on the City's
19 West Side by enabling the development of a mixed-use, urban, walkable and
20 transit-friendly environment that attracts employers and destination retail and
21 provides higher-density residential living options; and

22 WHEREAS, the Rank 1 Comprehensive Plan's update in 2013 designated
23 Volcano Heights as a Major Activity Center, as recommended by the Rank 2
24 West Side Strategic Plan's 2011 Volcano Mesa Amendment; and

25 WHEREAS, the Rank 2 West Side Strategic Plan's Volcano Mesa
26 Amendment establishes the policy to direct growth within the three Rank 3

1 Sector Development Plans – Volcano Cliffs, Volcano Trails, and Volcano
2 Heights; and
3 WHEREAS, the policies and regulations intended to be consistent among
4 the three plans were reviewed, revised, and refined throughout the process of
5 adopting the three Rank 3 plans, which were adopted in succession beginning
6 in May 2011 with Volcano Cliffs and ending in August 2013 with Volcano
7 Heights; and

8 WHEREAS, amendments are needed to reconcile the street network within
9 Volcano Mesa to incorporate cross sections for Volcano Cliffs and Volcano
10 Heights; and

11 WHEREAS, amendments are needed to reconcile adjustments made to the
12 design requirements for residential garages; strengthen regulations to
13 minimize fugitive dust during construction activities; organize regulations
14 regarding blasting in the Escarpment Transition zone; adjust regulations that
15 would have resulted in undesirable, unintended consequences; and correct
16 errata adopted in the original Plan; and

17 WHEREAS, amendments to the Volcano Heights Sector Development Plan
18 (VHSDP) are consistent with the applicable goals and policies of the
19 Albuquerque/Bernalillo County Comprehensive Plan, the West Side Strategic
20 Plan, the Facility Plan for Major Public Open Space, the Facility Plan: Electric
21 System Generation and Transmission, the Northwest Mesa Escarpment Plan,
22 and the Comprehensive Zoning Code.

23 BE IT RESOLVED BY THE COUNCIL, THE GOVERNING BODY OF THE CITY OF
24 ALBUQUERQUE:

25 Section 1. The City Council adopts the following findings:

26 1. The VHSDP area comprises 569 acres of land surrounding the
27 intersection of two significant regional roads, Unser Blvd. and Paseo del
28 Norte, and is bounded generally by existing development in Paradise Hills and
29 part of Paseo del Norte to the north, Universe Boulevard to the west, the
30 Volcano Cliffs Sector Plan area to the south, and the Petroglyph National
31 Monument to the east.

32 2. The Plan area is primarily undeveloped except for the two regional
33 roads that traverse it. It is surrounded by existing residential subdivisions and

[Bracketed/Underscored Material] - New
[Bracketed/Strikethrough Material] - Deletion

1 areas of platted land awaiting development. It is divided into approximately
2 100 properties ranging from 2.5 acres to 68 acres, which are owned by about
3 35 different property owners. Five property owners account for approximately
4 75% of the Plan area.

5 3. The Plan establishes the following SU-2 zones: Volcano Heights
6 Town Center (VHTC), Volcano Heights Regional Center (VHRC), Volcano
7 Heights Mixed Use (VHMX), Volcano Heights Escarpment Transition (VHET),
8 and Volcano Heights Neighborhood Transition (VHNT). No zone changes are
9 involved in the amendments; rather, revised design standards would equally
10 affect all properties.

11 4. The majority of the VHSDP area is within a part of the city
12 designated Developing or Established Urban by the Rank 1
13 Albuquerque/Bernalillo County Comprehensive Plan (Comprehensive Plan).
14 The VHSDP amendments implement and further the applicable Goals and
15 Policies of the Comprehensive Plan as follows:

16 A. Amendments affecting blasting within the SU-2/VHET
17 (Volcano Heights Escarpment Transition) zone, fugitive dust, and perimeter
18 walls will protect and preserve natural and cultural resources, vistas, and the
19 visual environment; provide visual variety in this Major Activity Center; and
20 emphasize new employment opportunities (II.B.1 Policy d, II.B.5 Policy d, II.B.7
21 Policy c, II.C.8 Policy a, II.C.9 Policy b, and II.D.6 Policy a).

22 B. Amendments to the transportation standards help protect
23 the livability and safety of residential neighborhoods and match street design
24 to community identity (II.B.5 Policy k and II.C.9 Policies b and e).

25 5. The VHSDP amendments implement and further the established
26 goals and policies of the Rank 2 West Side Strategic Plan as follows:

27 A. Amendments affecting blasting within the SU-2/VHET
28 (Volcano Heights Escarpment Transition) zone, fugitive dust, and perimeter
29 walls are intended to help protect the Escarpment, view sheds, and cultural
30 resources (Policy 3.99).

31 B. Adequate access and transportation choices for all users
32 within Volcano Mesa are supported by multi-modal cross sections (Policies
33 3.111 and 3.112).

1 6. The amendment to reorganize and consolidate blasting
2 regulations within the SU-2/VHET (Volcano Heights Escarpment Transition)
3 zone helps ensure appropriate construction mitigation near the Escarpment,
4 as set out in Policy 11 in the Rank 3 Northwest Mesa Escarpment Plan
5 (NWMEP).

6 Section 2. The City Council makes the following findings, which are
7 supported by and further elucidated in the complete record, as to compliance
8 with R-270-1980 with respect to the amendments affecting zoning standards
9 for residential garages:

10 1. With respect to Policy (A), the proposed zoning regulations
11 contribute to the general welfare of the neighborhood, community, and the
12 city because they contribute to a safer public right-of-way, enhance the public
13 realm, and help ensure a high-quality built environment.

14 2. With respect to Policy (B), the proposed zoning regulations
15 contribute to the stabilization of the area by setting standards for all
16 residential garages to ensure high-quality design. The standards are intended
17 to create a high-quality built environment compatible with and complementary
18 to the natural beauty of the Petroglyph National Monument, which surrounds
19 Volcano Mesa on three sides and protects a unique volcanic landscape in
20 perpetuity.

21 3. With respect to Policy (C), the proposed zoning standards are
22 consistent with and implement elements of the Rank 1 Comprehensive Plan,
23 Rank 2 West Side Strategic Plan, and Rank 3 Northwest Mesa Escarpment
24 Plan, as demonstrated below.

25 A. Rank 1 Comprehensive Plan:

26 (1) II.B.1. Open Space Goal and Policy b: Standards for
27 residential garages will help ensure that development adjacent to the
28 proposed Open Space network is compatible with open space purposes. The
29 standards are intended to ensure a high-quality built environment
30 commensurate with the beauty of the Petroglyph National Monument, which
31 surrounds the planning area on three sides. The standards reduce the
32 dominance of auto-oriented elements of residential lots and balance the
33 competing needs of pedestrians, residents, and drivers.

[Bracketed/Underscored Material] - New
[Bracketed/Strikethrough Material] - Deletion

- 1 (2) II.B.5 Developing and Established Urban Goal and
2 Policy d: Residential garage standards help ensure that the location,
3 intensity, and design of new development respects the natural environmental
4 conditions, scenic resources, and social, cultural, and recreational values and
5 opportunities connected to the Petroglyph National Monument.
6 (3) II.B.5 Developing and Established Urban Goal and
7 Policy f: Residential garage standards help ensure that houses are oriented
8 toward pedestrian walkways and share access with people other than drivers.
9 The proposed standards ensure facades that balance the orientation for
10 vehicle access via garages with the orientation for pedestrian access via
11 sidewalks and the public realm.
12 (4) II.B.5 Developing and Established Urban Goal and
13 Policy I: Residential garage standards encourage quality design in new
14 development and design that is appropriate to the Plan area.
15 (5) II.B.5 Developing and Established Urban Goal and
16 Policy m: Residential garage standards are an important part of the site
17 design that improves the quality of the visual environment.
18 (6) II.C.8. Environmental Protection and Heritage
19 Conservation Goal and Policy a: Residential garage standards are proposed
20 in the Plan area to respect the natural and visual environment, particularly the
21 unique Albuquerque feature that includes the volcanic landscape, of which the
22 Petroglyph National Monument is an integral part.
23 (7) II.C.8 Environmental Protection and Heritage
24 Conservation Goal and Policy e: In this highly scenic area, residential garage
25 standards ensure development design that is in harmony with the landscape.
26 (8) II.C.9 Community Identity and Urban Design Goal
27 and Policy b: Residential garage standards consider how best to design the
28 built environment to contribute to and enhance the natural environment,
29 including standards for the placement of entrances and windows, parking
30 areas and relationship to buildings, drive pads and curb cuts, and the massing
31 of buildings.
32 (9) II.D.4 Transportation and Transit Goal and Policy g:
33 Residential garage standards help protect pedestrians in the public realm,

[Bracketed/Underscored Material] - New
[Bracketed/Strikethrough Material] - Deletion

- 1 minimize opportunities for conflicts with auto access to individual properties,
2 and create pleasant non-motorized travel conditions.
3 (10) II.D.5 Housing Policy b: Residential garage
4 standards help promote quality in new housing design.
5 B. Rank 2 West Side Strategic Plan:
6 (1) Policy 3.99: The residential garage standards
7 establish design standards for developments in Volcano Mesa, which abuts
8 the Petroglyph National Monument, in order to recognize and respect the
9 sensitive ecological, historical and cultural importance of the area by ensuring
10 that development is compatible and contributes to a high-quality built
11 environment.
12 C. Rank 3 Volcano Heights Sector Development Plan:
13 (1) Environment and Open Space Goal 12.1.4:
14 Residential garage standards help minimize the visual impact of development
15 adjacent to the Escarpment and form a pleasant transition from the developed
16 to the natural area.
17 (2) Transportation Goals 12.3.1 and 12.3.3: Residential
18 garage standards are intended to contribute to pedestrian-friendly
19 thoroughfares that promote walking and help pedestrians feel safe and
20 comfortable.
21 (3) Land Use and Urban Design Goal 12.4.1: Residential
22 garage standards are intended to help create safe, comfortable, and visually
23 attractive settings to support the community's long-term economic, cultural,
24 and social viability.
25 (4) Land Use and Urban Design Goal 12.4.2: These
26 standards are part of a strategy to promote walking and create a walkable
27 district within Volcano Heights. Walkable neighborhoods have proven social
28 and economic benefits resulting from better access to basic needs and
29 amenities, safer and more active streets, and improved health through
30 physical activity, particularly for segments of the population without
31 automobile access, including youth and seniors.

[Bracketed/Underscored Material] - New
[Bracketed/Strikethrough Material] - Deletion

1 (5) Land Use and Urban Design Goal 12.4.3: Residential
2 garage standards are intended to ensure high-quality design for individual
3 buildings, which contributes to a sense of place and permanence.

4 (6) Land Use and Design Policy 13.4.3: These standards
5 are intended to contribute to a high-quality built environment, with particular
6 emphasis on providing visual interest at the scale of the pedestrian in order to
7 create a walkable district for residents, employees, and visitors.

8 4. With respect to Policy (D), existing zoning standards are
9 inappropriate and inadequate because the proposed revisions to the existing
10 residential garage standards are more advantageous to the community, as
11 articulated by the preponderance of applicable goals and policies in the
12 Comprehensive Plan and WSSP cited in Section C above.

13 A. There is a public need for the proposed standards, as
14 they help ensure a high-quality built environment that is more compatible with
15 the sensitive and unique volcanic landscape of which this Plan area is a part
16 and the permanent open space protected in perpetuity as the Petroglyph
17 National Monument. The residential standards also improve the safety and
18 continuity of the pedestrian realm in front of these residential properties.

19 B. The location of this Plan area, with its relationship to the
20 abutting Petroglyph National Monument, makes these residential standards
21 important and appropriate to meet the public need for high-quality built
22 environments and safe and continuous pedestrian realms.

23 5. With respect to Policy (E), these zoning standards affect one
24 permissive use for properties between 48 and 70 feet wide. Residential
25 garages for three or more cars would be prohibited for properties less than 70
26 feet wide; the existing standards specify a minimum of 48 feet to allow a
27 three-car garage. The more restrictive standard is intended to minimize the
28 proportion of the lot delegated for garage façade and ensure the safety and
29 quality of the pedestrian and public realm in front of residential lots. The
30 change is not harmful to adjacent property, neighborhood, or community;
31 rather the standards benefit surrounding property by ensuring a high-quality
32 built environment and safe pedestrian realm.

[Bracketed/Underscored Material] - New
[Bracketed/Strikethrough Material] - Deletion

1 6. With respect to Policy (F), this zoning standard does not require
2 major and unprogrammed capital expenditures by the city.

3 7. With respect to Policy (G), the cost of land and other economic
4 considerations are not the determining factor for the additional zoning
5 standards.

6 8. With respect to Policy (H), the proposed standards are not
7 intended for properties on major streets and does not affect apartment, office,
8 or commercial land uses.

9 9. With respect to Policy (I), the additional standards do not
10 constitute spot zoning.

11 10. With respect to Policy (J), the additional standards do not
12 constitute strip zoning.

13 Section 3. The City Council makes the following findings, which are
14 supported by and further elucidated in the complete record, as to compliance
15 with R-270-1980 with respect to the amendments affecting zoning standards
16 for the archaeological review of projects two or more acres in size and/or
17 properties on which a potential archaeological resource is discovered during
18 development or land disturbance:

19 1. With respect to Policy (A), the proposed zoning contributes to the
20 general welfare of the neighborhood, community, and the city. The proposed
21 zoning regulation would lower the threshold for archaeological review of site
22 development plans or master development plans and apply the Albuquerque
23 Archaeological Ordinance (City Zoning Code §14-16-3-20) on all properties,
24 regardless of size, in the event that a potential archaeological resource is
25 discovered during development or land disturbance. The proposed zoning
26 regulation would replace the existing regulation requiring a 50-foot setback
27 from any petroglyph or archaeological site. This proposed change removes a
28 potential impediment to development while protecting unique cultural and
29 historical resources, consistent with the goals and policies of the
30 Comprehensive Plan and other applicable plans. The proposed regulation has
31 no adverse effect on public facilities or services, fire and police facilities,
32 drainage facilities, or roadways. Where a petroglyph or other significant
33 archaeological resource is discovered within a proposed facility site or right-

[Bracketed/Underscored Material] - New
[Bracketed/Strikethrough Material] - Deletion

1 of-way, a Certificate of No Effect or a treatment plan would need to be
2 approved by the City Archaeologist, but no such condition is known at this
3 time.

4 2. With respect to Policy (B), the proposed requirement contributes
5 to the stabilization of the area by helping to preserve archaeological
6 resources and maintain a connection with the unique volcanic landscape and
7 continuous cultural and historical use by native peoples for centuries, while
8 still allowing for development on private property. The City and the federal
9 government protected much of this landscape in perpetuity by creating the
10 Petroglyph National Monument, which surrounds Volcano Mesa on three
11 sides. The Archaeological Ordinance in City Comprehensive Zoning Code
12 §14-16-3-20 defines archaeological resources of at least 75 years old that
13 might be considered significant and protects them from adverse impacts of
14 development. The Archaeological Ordinance is currently applicable for
15 projects five or more acres in size on property with SU-2 zoning requiring site
16 plan approval. The proposed regulation would extend the applicability of this
17 ordinance to projects 2 or more acres in size requiring site plan approval as
18 well as to any property on which a potential archaeological resource were
19 discovered. In the event that a potential archaeological resource were
20 discovered on private property of any size, the proposed requirement is
21 intended to determine its significance and encourage appropriate treatment
22 while still allowing for development on the remaining portion of the property.
23 The requirement is intended to encourage the conservation of petroglyphs
24 and other significant archaeological resources as integral parts of the unique
25 cultural, historical, and geologic landscape that includes the volcanoes,
26 basalt flow, and escarpment.

27 3. With respect to Policy (C), the proposed zoning standard is
28 consistent with and implements elements of the Rank 1 Comprehensive Plan,
29 Rank 2 West Side Strategic Plan, and Rank 3 Northwest Mesa Escarpment
30 Plan, as demonstrated below.

31 A. Rank 1 Comprehensive Plan:

[Bracketed/Underscored Material] - New
[Bracketed/Strikethrough Material] - Deletion

1 (1) II.B.1. Open Space Goal and Policy a: Adding the
2 proposed general standard will protect and preserve a natural resource and
3 environmental feature and conserve archaeological resources.

4 (2) II.B.1. Open Space Goal and Policy d : The proposed
5 regulation is intended to preserve petroglyphs and other archaeological
6 resources connected to the landscape, geology, and cultural importance of
7 the volcanoes, basalt flow, and escarpment.

8 (3) II.C.6. Archaeological Resources Goal and Policy b:
9 In the event that a significant archaeological resource is discovered, a
10 treatment plan must be prepared and approved by the City Archaeologist, who
11 can assure that the treatment is appropriate to preserve and/or protect
12 significant sites.

13 (4) II.C.9 Community Identity and Urban Design Goal
14 and Policy b: Preservation of petroglyphs and other significant archaeological
15 resources maintains the integrity of the volcanic landscape in a unique area of
16 Albuquerque with distinct and rich local history and cultural traditions dating
17 back to pre-historic use as prayer sites by Pueblo peoples that continues
18 today.

B. Rank 2 West Side Strategic Plan:

19 (1) Policy 3.103: The proposed regulation protects and
20 ensures conservation of archaeological and cultural resources.

21 (2) Policy 2.104: The proposed regulation requires the
22 appropriate treatment of significant archaeological resources, which may
23 include a buffer or setback from petroglyphs and archaeological sites, which
24 would be consistent with this policy that advocates a 50-foot setback from
25 petroglyphs for development, trails, and recreation areas.

26 (3) Policy 3.107: The proposed regulation would help
27 ensure conservation of rock outcroppings containing petroglyphs.

28 C. Rank 3 Volcano Heights Sector Development Plan:

29 (1) Environment and Open Space Goal 12.1.3:
30 Protecting petroglyphs and significant archaeological resources is part of
31 respecting Albuquerque's culture and history, including Native American
32 traditions, through contextually sensitive development of Volcano Heights.
33

[Bracketed/Underscored Material] - New
[Bracketed/Strikethrough Material] - Deletion

1 (2) Environment and Open Space Policy 13.1.3: The
2 proposed regulation provides flexibility that will help incentivize various
3 methods to conserve archaeological resources in Volcano Heights.
4 D. Rank 3 North West Mesa Escarpment Plan (NWMEP):
5 (1) Policy 10: The proposed regulation protects
6 significant archaeological sites.
7 4. With respect to Policy (D), existing zoning standards are
8 inappropriate and inadequate because removing the 50-foot buffer for
9 petroglyphs and replacing it with a standard is more advantageous to the
10 community. The proposed standard is more flexible and can be customized
11 more appropriately for any archaeological resources that are discovered and
12 found to be significant. This flexibility is expected to remove a potential
13 disincentive for compliance and help ensure the protection and preservation
14 of archaeological resources, particularly petroglyphs, as articulated by the
15 preponderance of applicable goals and polices in the Comprehensive Plan,
16 WSSP, and NWMEP cited in Section C. The proposed zoning standard helps
17 conserve unique natural and cultural resources; preserve the connection to a
18 unique natural and cultural landscape – a large portion of which is preserved
19 in perpetuity by the Petroglyph National Monument; and maintain the cultural
20 and historical importance of these petroglyphs for the public and the Pueblo
21 people.
22 A. There is a public need for the proposed standard;
23 petroglyphs and other significant archaeological resources are unique and
24 irreplaceable. They are an integral part of a cultural, historical, and geological
25 landscape that contributes to the richness of Albuquerque and the value of
26 the priceless Petroglyph National Monument. It serves the public interest to
27 preserve these unique resources and help protect the integrity of this unique
28 landscape. Preserving these resources in perpetuity allows for future
29 opportunities for research, experience, and education.
30 B. The threshold for archaeological review should be
31 extended within Volcano Mesa because this area was used heavily over time
32 by Pueblo people for cultural and spiritual rituals connected to the volcanic
33 landscape. The Petroglyph National Monument preserved the most heavily

[Bracketed/Underscored Material] - New
[Bracketed/Strikethrough Material] - Deletion

1 Section 5. All development activities within the Volcano Heights Sector
2 Development Plan boundaries shall be guided and regulated by the policies,
3 standards, and regulations of the VHSDP.
4 Section 6. EFFECTIVE DATE. This resolution shall take effect five days
5 after publication by title and general summary.
6 Section 7. SEVERABILITY CLAUSE. If any section paragraph, sentence,
7 clause, word, or phrase of this resolution is for any reason held to be invalid
8 or unenforceable by any court of competent jurisdiction, such decision shall
9 not affect the validity of the remaining provisions of this resolution. The
10 Council hereby declares that it would have passed this resolution and each
11 section, paragraph, sentence, clause, word or phrase thereof irrespective of
12 any provisions being declared unconstitutional or otherwise invalid.
13
14
15
16
17
18
19
20
21
22
23
24
25
26
27
28
29
30
31
32
33 X:\CITY COUNCIL\SHARE\CL-Staff_Legislative Staff\Legislation\21 Council\R-72final.docx

1 PASSED AND ADOPTED THIS 6th DAY OF October, 2014
2 BY A VOTE OF: 8 FOR 0 AGAINST.

3
4 Excused: Garduño

5
6
7 
8 _____
9 Ken Sanchez, President
10 City Council

11
12
13 APPROVED THIS 22nd DAY OF October, 2014

14
15
16 Bill No. R-14-72

17
18
19 
20 _____
21 Richard J. Berry, Mayor
22 City of Albuquerque

23
24
25
26 ATTEST:

27 
28 _____
29 Trina M. Gurule, Acting City Clerk

[+Bracketed/Underscored Material+] - New
[-Bracketed/Strikethrough Material-] - Deletion

TABLE OF CONTENTS

CHAPTER I: INTRODUCTION

1.0	Executive Summary	Page 3
1.1	Plan Area	4
1.2	Purpose	4
1.3	Intent	4
1.4	Strategy for Zoning	4
1.5	Strategy for Development Standards	6
1.6	Anticipated Build-out by 2035	7
1.7	Plan Components	8
1.8	Using This Plan	10

CHAPTER II: REGULATIONS

2.0	Plan Authority	Page 15
2.1	Rank Plans	16
2.2	Northwest Mesa Escarpment Plan (NWMEP)	17
2.3	Unser Boulevard Design Overlay Zone (DOZ)	18
2.4	City Zoning Code	20
2.5	City Subdivision Ordinance	20
2.6	Development Process Manual (DPM)	20
2.7	Other City Regulations	20
3.0	Administration	Page 21
3.1	Applicability	22
3.2	Development Review and Approval Process	22
3.3	Amendments to the SDP and/or Zoning Map	34
3.4	Public Notification	35
3.5	Definitions	40

4.0	Zoning	Page 55
4.1	Adoption of Volcano Heights Zoning	57
4.2	Establishment of Character Zones	61
4.3	Table of Land Uses	63
4.4	Criteria for Conditional Uses	71
5.0	Site Development and Building Design Standards Specific to Zones	Page 77
5.1	Town Center	78
5.2	Regional Center	84
5.3	Village Center	90
5.4	Mixed-Use	95
5.5	Escarpment Transition	101
5.6	Neighborhood Transition	106
6.0	Site Development Standards General to All Zones	Page 109
6.1	Gated Communities	110
6.2	Neighborhood Design	110
6.3	Structure Heights	110
6.4	Optional Height Bonus for Buildings	111
6.5	Grading	116
6.6	Construction Mitigation	118
6.7	Infrastructure	121
6.8	Street Screens	123
6.9	Design of Site Elements for Automobile-related Uses	124

Table of Contents *(cont'd)*

7.0	Building Design Standards General to All Zones	Page 125
7.1	Purpose / Intent	126
7.2	Building Orientation	126
7.3	Building Massing and Scale	126
7.4	Zero Lot Line Structures	127
7.5	Structure Color	127
7.6	Design of Parking Structures	128
7.7	Design of Residential Garages	129
7.8	Design of Automobile-related Buildings	131
7.9	Wireless Telecommunications Facilities (WTFs)	131
8.0	Sign Standards	Page 133
8.1	Applicability	134
8.2	Unique Sign Applications	134
9.0	Open Space, Landscaping, and Site Lighting Design Standards	Page 141
9.1	Purpose / Intent	142
9.2	Applicability	142
9.3	Open Space Requirements	142
9.4	Detached Open Space Standards	143
9.5	Usable Open Space Standards	144
9.6	Petroglyphs	146
9.7	Landscaping Standards	151
9.8	Site Lighting Standards	159

CHAPTER III: STREET AND STREETScape STANDARDS

10.0	Street Standards	Page 163
10.1	Purpose / Intent	164
10.2	Applicability	164
10.3	How to Use These Standards	164
10.4	Access	169
10.5	Street Designations	171
10.6	Primary Street Cross Sections	173
10.7	Secondary Street Design Standards	199
11.0	Streetscape Standards	Page 205
11.1	Adjustments	206
11.2	General Streetscape Standards	206
11.3	Street Tree Standards	207
11.4	Street Lighting Standards	209
11.5	Street Furniture and Materials Standards	210

Table of Contents *(cont'd)*

CHAPTER IV: GOALS, POLICIES, AND IMPLEMENTATION

12.0	Goals	Page 213
12.1	Environment and Open Space	214
12.2	Economic Development	215
12.3	Transportation	217
12.4	Land Use and Urban Design	218
12.5	Infrastructure	221
13.0	Policies	Page 223
13.1	Environment and Open Space	224
13.2	Economic Development	225
13.3	Transportation	226
13.4	Land Use and Design	238
13.5	Infrastructure	241
14.0	Implementation	Page 245
14.1	Priority Capital Improvement Projects	246
14.2	Implementation Responsibilities	247
14.3	Optional Financial Tools	248
14.4	Amending This Sector Development Plan	249
14.5	Implementation Matrix	249

APPENDIX [UNDER SEPARATE COVER]

Appendix A.	Pre-existing Conditions	
Appendix B.	Sector Planning Process	
Appendix C.	2013 Access Resolution for Paseo del Norte and Unser Boulevard and Traffic Study	
Appendix D.	Private Preservation Options	
Appendix E.	Fiscal Impact Analysis	

EXHIBITS

		Page
1.1	Volcano Mesa Sector Development Plan Areas	5
1.2	Volcano Heights Plan Area	6
2.1	NWMEP and WSSP Volcano Mesa Amendment Boundaries	17
2.2	Unser Boulevard Design Overlay Zone Boundary	19
3.1	Volcano Heights Approval Process Diagram	23
4.1	Zoning Established by the VHSDP	56
4.2	Zoning Demarcation for Properties with Multiple Zones	57
6.1	Impact Area and 200-foot Buffer	110
7.1	Sample Colors	127
7.2	Residential Garage Type Diagrams	130
8.1	Unser Design Overlay Zone within the Volcano Heights Plan Area	135
9.1	Significant Rock Outcroppings	147
10.1	Primary Streets and Designations Map	165
10.2	Character Zones and Street Types	166
10.3	Approved Limited-access Intersections	169
10.4	Street Type 1 – Town Center Cross Section	193
10.5	Street Type 1 – Typical Intersection (Plan View)	194
10.6	Street Type 2 – Connector Street Cross Section	183
10.7	Street Type 2 – Typical Intersection (Plan View)	184
10.8	Street Type 3 – Neighborhood Street Cross Section	179
10.9	Street Type 3 – Typical Intersection (Plan View)	180
10.10	Street Type 4.1 – Park Edge Single-Loaded Cross Section	196
10.11	Street Type 4.2 – Park Edge Double-Loaded Cross Section	196
10.12	Street Type 4.1 – Typical Intersection (Plan View)	197
10.13	Street Type 4.2 – Typical Intersection (Plan View)	198
10.14	Street Type 5 – Transit Boulevard Cross Section	191
10.15	Street Type 5 – Typical Intersection (Plan View)	192
10.16	Street Type 6 – Unser Boulevard Cross Section	189
10.17	Street Type 7 – Paseo del Norte Cross Section	190

Table of Contents *(cont'd)*

EXHIBITS <i>(cont'd)</i>	Page
10.18 Street Type 8 – Universe Boulevard Cross Section	182
10.19 Example Diagrams: Alley Configurations with ‘A’ vs. ‘B’ Street Percentages	199
10.20 Typical ‘A’ Street	201
10.21 Typical ‘B’ Street	202
10.22 Typical Residential Alley Cross Section	203
10.23 Typical Commercial Alley Cross Section	203
13.1 Volcano Mesa Road Network	227
13.1 Circuitous vs. Direct Pedestrian Routes to Transit Stops	232
13.2 Reverse-angle Parking Examples	234
13.3 Roundabout vs. Typical Intersection Conflict Points	235
13.4 Sample Transition to Density Over Time	240
13.5 Recommended Rainwater Design Techniques	243

TABLES	Page
1.1 Volcano Heights Anticipated Development Total by Land Use	7
1.2 Anticipated Development by Character Zone	7
1.3 Street Hierarchy and Street Designations Matrix	9
2.1 Relevant Ranked Plans	16
3.1 Applicability of Plan Sections by Development Type	24
3.2 Minor Deviation Criteria	31
3.3 Major Deviation Criteria	33
3.4 Approval Process and Notifications: Site Plans for Subdivision	36
3.5 Approval Process and Notifications: Site Plans for Building Permit	37
3.6 Approval Process by Development Type	38
4.1 Zone Demarcation for Properties with Multiple Zones	58
4.2 Alphabetical Index of Properties with Multiple Zones	61
4.3 Character Zones by Land Use Category	62

TABLES <i>(cont'd)</i>	Page
4.4 Land Use Table by Character Zone	64
4.5 Conditional Use Criteria	71
6.1 Total Points for Building Height Bonus by Character Zone	112
6.2 Bonus Height Points Per Criterion	113
6.3 Standards for Optional Height Bonus Criteria	114
7.1 Garage Types	129
8.1 Sign Types by Character Zone	136
9.1 Types of Open Space	142
9.2 Detached Open Space: Residential Uses	143
9.3 Detached Open Space: Non-Residential Uses	143
9.4 Open Space Criteria	148
9.5 Plant List	153
10.1 Adjustment Criteria	168
10.2 Secondary Street Requirements	199
10.3 Typical Secondary Street and Alley Cross Section Options	200
13.1 Appropriate Density and Land Use by Zone	238
13.2 Locations Appropriate for Low-Impact Design (LID) by Scale	242
13.3 Objectives and Recommendations for LID by Design Element	243
14.1 Implementation Matrix	250

LIST OF ACRONYMS

AASHTO:	American Association of State Highway and Transportation Officials	LID*:	Low Impact Design	SAD:	Special Assessment District
ABCWUA:	Albuquerque-Bernalillo County Water Utility Authority	LRV:	Light Reflective Value	SDP:	Sector Development Plan
ADA:	Americans with Disabilities Act	MAC:	Major Activity Center	SF:	Square Feet
AMAFCA:	Albuquerque Metropolitan Area Flood Control Authority	MPO:	Metropolitan Planning Organization	SIA:	Subdivision Improvement Agreement
AMPA:	Albuquerque Metropolitan Planning Area	MPOS:	Major Public Open Space	TCC:	Transportation Coordinating Committee
BID:	Business Improvement District	MRCOG:	Mid-Region Council of Governments	TDM:	Travel Demand Model
BRT*:	Bus Rapid Transit	MRMPO:	Mid-Region Metropolitan Planning Organization	TIF:	Tax Increment Financing
BTZ*:	Build-to Zone	MTB:	Metropolitan Transportation Board	TIDD:	Tax Increment Development District
CABQ:	City of Albuquerque	MTP:	Metropolitan Transportation Plan	VHET:	Volcano Heights Escarpment Transition Zone
DMD:	City Department of Municipal Development	MUTCD:	Manual on Uniform Traffic Control Devices	VHMX:	Volcano Heights Mixed-use Zone
DOZ:	Design Overlay Zone	NMDOT:	New Mexico Department of Transportation	VHNT:	Volcano Heights Neighborhood Transition Zone
DPM:	Development Process Manual	NOD:	Notice of Decision	VHRC:	Volcano Heights Regional Center Zone
DRB:	Development Review Board	NWMEP:	Northwest Mesa Escarpment Plan	VHRT:	Volcano Heights Review Team
DRC:	City Design Review/Construction Section	ONC:	City Office of Neighborhood Coordination	VHSDP:	Volcano Heights Sector Development Plan
DRT:	Design Review Team	POA:	Property Owners Association	VHTC:	Volcano Heights Town Center
EIFS:	Exterior Insulating Finishing System	PID:	Public Improvement District	WSSP:	West Side Strategic Plan
EPC:	Environmental Planning Commission	PNM:	Public Service Company of New Mexico (Electric Utility)	WTF:	Wireless Telecommunications Facility
FAABS:	Future Albuquerque Area Bikeways and Streets	PRT:	Pre-application Review Team	ZHE:	City Zoning Hearing Examiner
FHWA:	Federal Highway Administration	PUE:	Public Utility Easement		
FTE:	Full Time Equivalent (Employee)	RI/RO:	Right-in / Right-out (Intersection)		
GSF*:	Gross Square Feet	ROW:	Right-of-Way		
HOA:	Homeowners Association				
HOV:	High-occupancy Vehicle				
ITE:	Institute of Transportation Engineers				
ITS*:	Intelligent Transportation Systems				

* See **Section 3.5. Definitions** starting on page 40 for full definitions, which include any term other than a section heading or cross reference that appears as bold in this Plan.

QUICK REFERENCE ZONE MATRIX

Notes:

- (1) These summary tables are meant for quick reference only and do not provide complete information. See Plan regulations for details.
- (2) Uses are regulated by Character Zone and can be found in **Table 4.4** starting on page 64.
- (3) Frontage standards are handled by Character Zone in **Section 5** starting on page 77 and summarized here.

CHARACTER ZONE	SECONDARY STREETS		BUILDING FRONTAGE REQUIRED	
	'A' Street (min.)	'B Street' (max.)	'A' Street (min.)	'B Street' (min.)
Town Center	50%	50%	80%	30%
Regional Center	25%	75%	60%	20%
Village Center	25%	75%	60%	30%
Mixed Use	25%	75%	50%	25%
Escarpment Transition	25%	75%	60%	30%
Neighborhood Transition	0%	100%	60%	30%

CHARACTER ZONE	TOTAL ACREAGE	MAX. HEIGHT	BONUS HEIGHT	BLOCK LENGTH	BLOCK PERIMETER	SETBACKS (feet)		BUILT-TO ZONE (feet)	
	(in acres)	(in feet)	(in feet)	(in feet)	(max. in feet)	Front 'A' Streets	Front 'B' Streets	'A' Street	'B Street'
Town Center	83	40	75	225 - 500	2,000	5	10	0-10	0-15
Regional Center	109	40	60	300-800	2,200	5	10	0-15	0-15
Village Center	12	40	60	300-800	2,000	5	10	0-10	0-20
Mixed Use	219	26	40	300-1200	3,600	5	10	0-15	0-20
Escarpment Transition	68	26*	NA	250-600	2,000	5	10	0-10	0-20
Neighborhood Transition	33	26	NA	200-600	2,000	5	10	0-10	0-20

* Structures within the Impact Area of the Northwest Mesa Escarpment Plan are restricted to 15 feet. Beyond the Impact Area, structures within 200 feet of the Petroglyph National Monument boundary are restricted to 18 feet, with up to 50% of the building footprint allowed to go up to 26 feet.

In order to provide predictability of high-quality built environment along corridors, across property lines, and over time, this Plan includes Site Development and Building Design Standards by Character Zone in **Sections 5-7** as well as Streets and Streetscape Standards in **Sections 10 and 11**.

- Primary Street cross sections are found in **Section 10.6** starting on page 173.
- Secondary Street cross section options are found in **Section 10.7** starting on page 199.

CHAPTER I

CHAPTER I

introduction

This Page Left Intentionally Blank

I.0 EXECUTIVE SUMMARY

I.0 EXECUTIVE SUMMARY

1.1. Plan Area

Volcano Heights is one of three Sector Development Plan areas in Volcano Mesa. [See **Exhibit I.1**].

The Volcano Heights Sector Development Plan (SDP) is bordered by Paseo del Norte to the north before it curves southeast, the Petroglyph National Monument on the east, Volcano Cliffs SDP boundary on the south, and Universe Boulevard on the west. The Plan area includes approximately 570 acres and surrounds the intersection of Paseo del Norte and Unser Boulevard— two vital, regional traffic arteries.

1.2. Purpose

The purpose of the Plan is to support pedestrian-friendly and transit-supportive development with particular emphasis on employment, while buffering pre-existing single-family neighborhoods and sensitive lands on the borders of the Plan area from higher-density development toward the center of the Plan area. The Plan seeks to create a walkable, urban center with a sense of place rooted in its unique volcanic context and with development that respects the Petroglyph National Monument, which includes over 10,000 acres of open space preserved in perpetuity by an act of Congress in 1990.

1.3. Intent

The intent of this Plan is to encourage development that creates an attractive, vibrant Major Activity Center that respects and honors the unique cultural, historical, geological, and volcanological setting, while providing employment, services, amenities, housing, and transportation choices for the larger region as part of a sustainable community on Albuquerque's West Side.

Adding jobs, urban and mixed-use housing options, and regional retail opportunities in Volcano Heights is part of a larger strategy to provide a center on the West Side that can begin to address the imbalance of jobs and housing that is expected to contribute to increasing traffic congestion on the region's river crossings in the future.

The zoning and corresponding standards are created to support economic development, a sustainable tax base, and job creation by establishing the predictability of private development along corridors and across property lines to support and leverage investment in Volcano Heights. Infrastructure and utilities, such as safe, reliable electric service, are essential to economic development for the Plan area.

The Plan aims to encourage attractive development through the use of recognized principles of urban design and to allow property owners flexibility in land use, while providing predictability through a higher level of detail in proscribed site development standards, building design, and the form of the built environment.

1.4. Strategy for Zoning

All zones in Volcano Heights allow a mix of residential and non-residential development in order to provide maximum flexibility to property owners to adapt to market conditions over time and to encourage a mix of housing and services within walking and biking distance. [See **Exhibit 4.1** on page 64.]

East of the intersection of Paseo del Norte and Unser Boulevard, the Plan envisions a Town Center with employment-oriented development and entertainment uses organized around a planned transit corridor. Development lining these vital regional auto transportation corridors in the Regional Center Zone is intended to support auto-oriented, destination retail and businesses accessed from local roads.

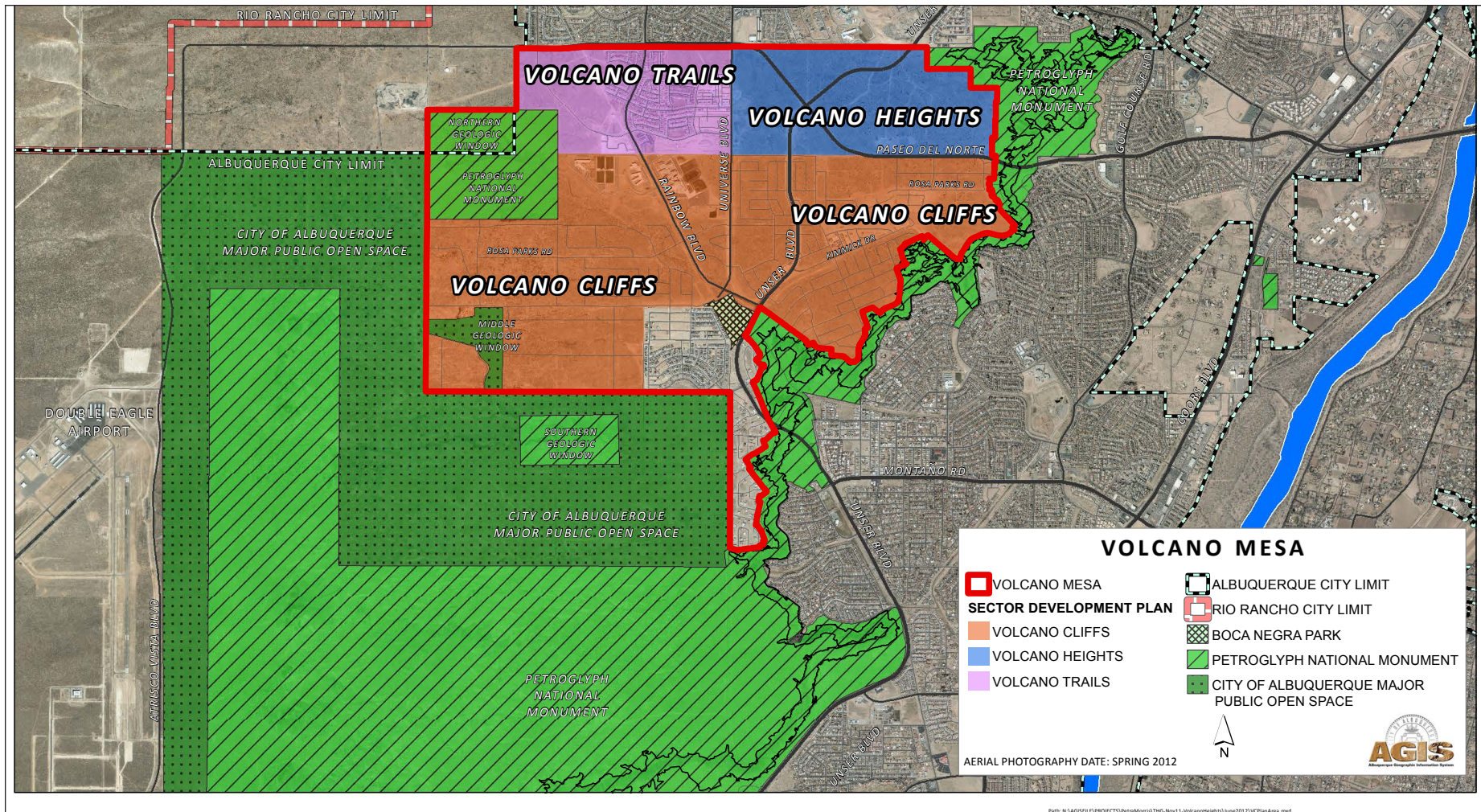

EXHIBIT I.1 – VOLCANO MESA SECTOR DEVELOPMENT PLAN AREAS

Surrounding the Town Center and Regional Center, the Plan offers pedestrian-oriented, mixed use development opportunities with convenient access between new and existing neighborhoods and shopping, employment, services, and amenities throughout the Plan area.

One Village Center is incorporated at the intersection of Paseo del Norte and Universe Boulevard, mirroring a Village Center in Volcano Trails.

CHAPTER I: INTRODUCTION

1.0 EXECUTIVE SUMMARY

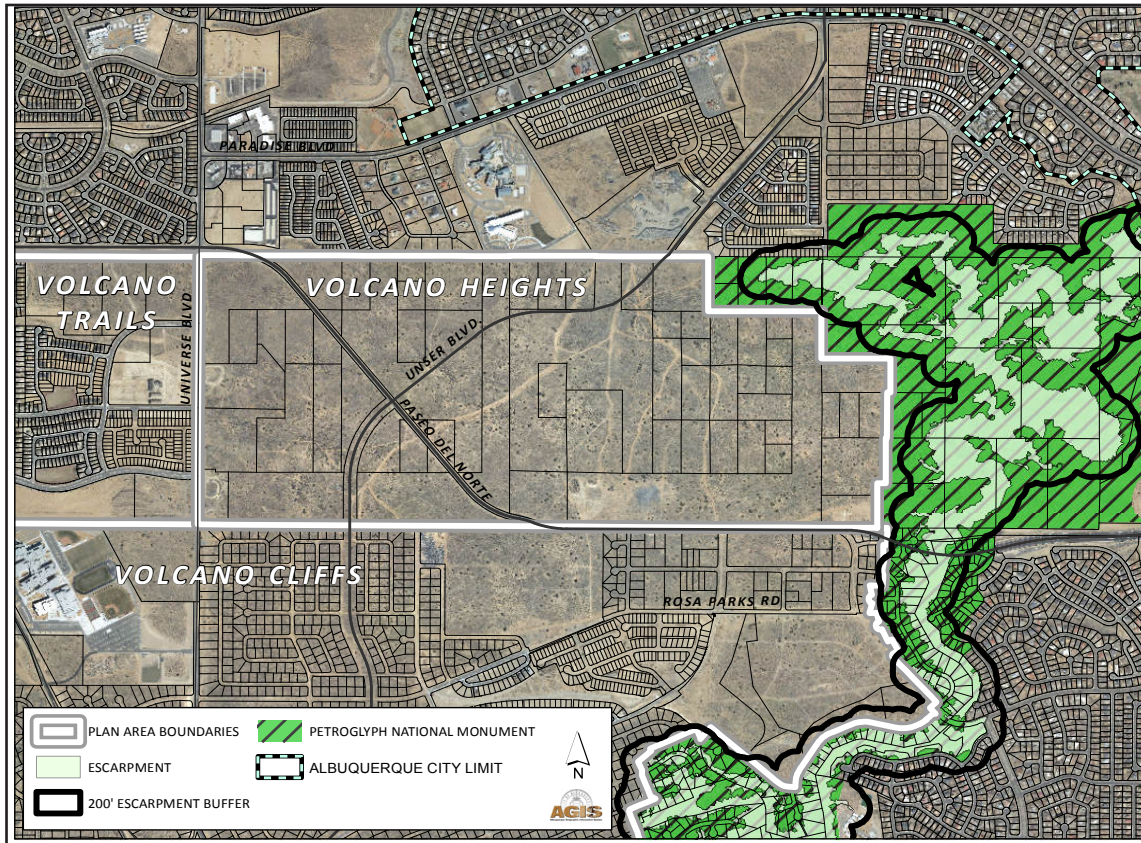
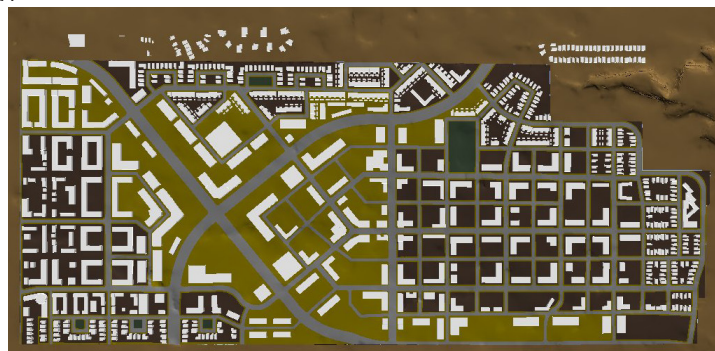

EXHIBIT 1.2 – VOLCANO HEIGHTS PLAN AREA

ILLUSTRATION – Example of potential development layout assuming Anticipated Build-out levels by 2035



The Plan includes two types of transition zones as buffers between development densities and intensities: (1) Neighborhood Transitions to ensure that new development is compatible with single-family residential areas to the north and south of the Plan area and (2) an Escarpment Transition in the eastern part of the Plan area to ensure development compatible with sensitive lands within the Petroglyph National Monument.

As Volcano Heights is a unique landscape that shares a border with the Petroglyph National Monument, the Plan takes an innovative approach toward building height limits to concentrate opportunities for height and density toward the center of the Plan area and step heights down toward the edges with Transition zones. The Plan offers an optional bonus height system as an incentive to preserve and provide public access to rock outcroppings and other sensitive lands. [See **Section 6.4 Optional Height Bonus for Buildings** starting on page 111.]

1.5. Strategy for Development Standards

The Plan implements the vision for Volcano Heights as established by the zoning map. [See **Exhibit 4.1** on page 64.] The zoning requires minimum standards to guide property owners, developers, and the City on the form, character, and intensity of desired future development within key locations and along key corridors in the Plan area. Six distinct character zones enumerate specific site, building design, and other development standards as basic building blocks to create sense of place. Clear graphic standards are provided for location, height, and building design elements.

Such standards promote predictability of adjacent developments, flexibility in land use, walkable and transit-supportive mixed-use development, transitions to existing neighborhoods, and protection of natural and cultural resources.

I.0 EXECUTIVE SUMMARY

1.6. Anticipated Build-out by 2035

The zoning and development standards for Volcano Heights allow more density and intensity of uses than it seems the market will support in the foreseeable future in order to maximize density and thus walkability and transit serviceability where development occurs. The following development scenario represents an optimistic yet realistic vision for the ultimate build-out of Volcano Heights by 2035, based on the developable area in each zone and assuming the required internal street network, the preservation of significant rock outcroppings, and the achievement of bonus heights where they are allowed.

The Major Activity Center consists of the non-Transition Zones (approximately 477 acres). Consistent with the goal of providing a Major Activity Center, more retail and office uses are proposed than residential dwelling

units in these zones. Based on conservative estimates of employees per square feet for different land uses, the total jobs associated with the realistic vision for 2035 full build-out is approximately 5,400. No jobs are estimated in the Neighborhood Transition zone, so after removing that acreage, Volcano Heights would average an estimated 10 jobs per acre [i.e. 5,389 jobs / (570-32 acres)] including the Escarpment Transition zone. Based on an average household size of 2.7 people per dwelling unit, consistent with West Side demographics nearby, this anticipated build-out includes approximately 13,000 additional residents.

This anticipated build-out was also used as the base assumption for the traffic study for Volcano Heights found in **Appendix C**.

TABLE I.1 – VOLCANO HEIGHTS ANTICIPATED DEVELOPMENT TOTAL BY LAND USE

RESIDENTIAL	4,769 UNITS
HOTEL	53,600 square feet
OFFICE	1,180,135 square feet
RETAIL	819,498 square feet
OFFICE + RETAIL	1,999,633 square feet

TABLE I.2 – ANTICIPATED DEVELOPMENT BY CHARACTER ZONE

CHARACTER ZONE	UNIT COUNT			SQUARE FOOTAGE (SF)				
	Single-family detached	Single-family attached	Multifamily	Hotel	Office	Regional Retail	Specialty Retail	Local Retail
Town Center (VHTC)	0	0	1,406	0	552,650	25,000	125,000	25,000
Regional Center (VHRC)	0	0	551	0	352,800	301,700	131,600	47,600
Village Center (VHVC)	0	0	99	0	20,685	0	65,598	0
Mixed Use (VHMX)	0	165	2,002	0	254,000	0	0	80,000
Escarpment Transition (VHET)	234	126	56	53,600	0	0	0	18,000
Neighborhood Transition (VHNT)	130	0	0	0	0	0	0	0
VOLCANO HEIGHTS TOTAL	364	291	4,114	53,600	1,180,135	326,700	322,198	170,600
FULL-TIME EQUIVALENT (FTE) JOB ESTIMATE	NA	NA	NA	600 SF/FTE	300 SF/FTE	600 SF/FTE	600 SF/FTE	600 SF/FTE
JOB ESTIMATE TOTAL	NA	NA	NA	89	3934	545	537	284

1.0 EXECUTIVE SUMMARY

The hotel noted in the Escarpment Transition zone was an idea floated by community members during a public meeting. If realized, this facility could honor the unique geological, cultural, and historical context of this area and leverage the permanent open space, recreation opportunities, and spectacular views to create a destination spa/retreat/resort that would set the tone for the character of surrounding development and help anchor the area as a unique destination. While it is a use allowed by zoning, there is no requirement in this Plan that it be constructed or recommendation of its exact location.

1.7. Plan Components

The VHSDP shall provide the official zoning map. It establishes the development standards for all properties within the Plan area, including the following:

1.7.1. Character Zones

The zoning map designates all property in Volcano Heights as one of six character zones, described in **Section 4.0 Zoning** starting on page 55. Each character zone is intended to create a distinct urban form and a mix of residential and commercial uses.

Each character zone establishes the following:

- (i) The intended character of each zone in **Section 4.0 Zoning**, with land uses for each zone per **Table 4.4** on page 64, including permitted, conditional, and prohibited uses.
- (ii) Site Development and Building Design Standards, including building and parking location, height, massing, glazing, materials, and design, for each character zone per **Section 5.0** starting on page 77.

1.7.2. Regulations General to All Zones

The Plan provides standards applicable to all development regardless of character zone. These are presented in separate sections according to subject.

- (i) **Section 6.0 Site Development Standards** starting on page 109, including an optional bonus height system for buildings, grading standards, construction mitigation, utilities, screening, and rainwater harvesting equipment. The optional bonus height system is intended to provide additional height and density incentives for developments in appropriate locations that enhances the built and natural environments.
- (ii) **Section 7.0 Building Design Standards** starting on page 125, including building orientation, mass, scale, and color; parking structure and residential garage design; auto-oriented design and **street screens**; and communication antennae.
- (iii) **Section 8.0 Sign Standards** starting on page 133 with a table for anticipated sign elements.
- (iv) **Section 9.0 Open Space, Landscaping, and Site Lighting Design Standards** starting on page 141, including detached and **usable open space**, landscape, and site lighting.

I.0 EXECUTIVE SUMMARY

1.7.3. **Streets and Streetscape Standards**

Streets in Volcano Heights are to be constructed at the time of the property’s development. All streets and streetscape standards are described in **Section 10.0 Street Standards** starting on page 163. This Plan includes a street hierarchy of **Primary Streets** versus **Secondary Streets** and **street designations** of ‘A’ versus ‘B’ streets.

(i) **Primary Streets:** The Primary Street Map designates street types according to desired character of development along corridors, as well as designating **Primary Streets** as ‘A’ Streets versus ‘B’ Streets within the Plan area. All streets, whether ‘A’ or ‘B,’ whose alignments are mapped in **Exhibit 10.1** in **Section 10.4** are considered **Primary Streets** and should be constructed in that approximate location, with those general connections to other **Primary Streets**, and according to the cross section for the appropriate street type as shown in **Section 10.6** starting on page 173.

(ii) **Secondary Streets:** **Secondary Streets** are those local roads constructed to serve development projects and contribute to the local street network grid. These streets, described in **Section 10.7**, are to be constructed per a menu of cross section options in **Table 10.3**, based on whether they are to be designated ‘A’ or ‘B’ **Streets** (i.e. primarily to serve pedestrians or to provide vehicle access). Typical cross sections are provided in **Exhibit 10.20** and **Exhibit 10.21**.

TABLE I.3 – STREET HIERARCHY AND STREET DESIGNATIONS MATRIX

STREET HIERARCHY	STREET DESIGNATIONS	
	‘A’ Streets	‘B’ Streets
Primary Streets: <ul style="list-style-type: none"> Alignments & connections mapped Required cross sections by street type Primarily serve street network 	<ul style="list-style-type: none"> Primary Streets and portions of Primary Streets that are pedestrian-oriented Limited curb cuts Primary building frontage 	<ul style="list-style-type: none"> Primary Streets and portions of Primary Streets that are auto-oriented Curb cuts, parking, and alley access Primary service/loading access
Secondary Streets: <ul style="list-style-type: none"> Not mapped Cross section options by street designation Primarily serve local development projects 	<ul style="list-style-type: none"> Secondary Streets and portions of Secondary Streets that are pedestrian-oriented Limited curb cuts Primary building frontage 	<ul style="list-style-type: none"> Secondary Streets and portions of Secondary Streets that are auto-oriented Curb cuts, parking, and alley access Primary service/loading access

I.0 EXECUTIVE SUMMARY

This document must be read in its entirety to ensure full comprehension of the policies and regulations governing properties within the boundaries of the Volcano Heights Sector Development Plan.

1.8. Using This Plan

1.8.1. Plan Organization

- (i) **Chapter I** summarizes the purpose and intent of the Plan.
- (ii) Only **Chapter II** includes regulations with the power of law, including zoning and all design and development regulations and standards.
- (iii) **Chapter III** provides standards for streets and streetscapes to be followed as properties develop individually and/or infrastructure is constructed as part of a coordinated effort.
- (iv) **Chapter IV** provides goals, policy and implementation guidance for City staff and developers organized around five main topics: Environment and Open Space; Economic Development; Transportation; Land Use and Urban Design; and Infrastructure.
- (v) The **Appendix** includes supplementary information, including conditions prior to the Plan's adoption, templates for conservation easements, and a traffic study performed for the **Primary Street** grid and recommended intersections with the limited-access roadways.

- 1.8.2. **Project Development Steps:** The following basic steps should be followed to determine the uses and development standards applicable on property within Volcano Heights, including where the building can sit on the **lot**, limits on its three-dimensional form, range of uses allowed, and palette of materials that will cover it.
- (i) Review **Exhibit 3.1**, the development review flow chart, on page 23 [copied for convenience at the end of this section] to determine the level of review required based on whether significant infrastructure coordination is needed for the proposed project.
 - (ii) Locate the subject property in **Exhibit 10.2** on page 166 and identify:
 - a. the character zone(s) in which the property is located and
 - b. the Street Type designation along all its **Primary Street** frontages, if any.
 - (iii) Review **Table 4.4 – Land Use Table by Character Zone** starting on page 64 to determine allowed uses.
 - (iv) Review **Table 3.1 – Applicability of Plan Sections by Development Type** starting on page 24 to evaluate the applicability of the uses and design standards/regulations based on the size and scope of the proposed project.

- (v) Examine **Section 5.0 Site Development and Building Design Standards Specific to Zones** starting on page 77 to determine the applicable development standards and any special frontage standards for each character zone.
- (vi) Refer to **Section 6.0 Site Development Standards** starting on page 109 for regulations at the site level that apply generally to all zones.
- (vii) Refer to **Section 7.0 Building Design Standards** starting on page 125 for regulations at the building level that apply generally to all zones.
- (viii) Refer to **Section 8.0 Sign Standards** starting on page 133 for regulations about signage that apply generally to all zones.
- (ix) Refer to **Section 9.0 Open Space, Landscaping, and Site Lighting Design Standards** starting on page 141 for regulations about open space, landscaping, and site lighting design that apply generally to all zones.
- (x) Review **Section 10.0 Street Standards** starting on page 163 for relevant **Primary Streets** and options for **Secondary Streets** proposed to serve the project.
- (xi) Projects are also subject to the City's Development Process Manual (DPM) [under separate cover], ordinances, and regulations not in conflict with this Plan.
- (xii) Prior to any application, schedule a free Pre-Application Review Team (PRT) meeting with the Planning Department to confirm the necessary review process based on the project scope.
 - a. If significant infrastructure is required, submit Site Development Plans for Subdivision to the Development Review Board for a free sketch plat review.
 - b. If no significant infrastructure is required, schedule a free Design Review Team (DRT) meeting with the Planning Department to review Site Plans for Building Permit and determine compliance with the policies and regulations in this Plan.

1.0 EXECUTIVE SUMMARY

VOLCANO HEIGHTS APPROVAL PROCESS DIAGRAM

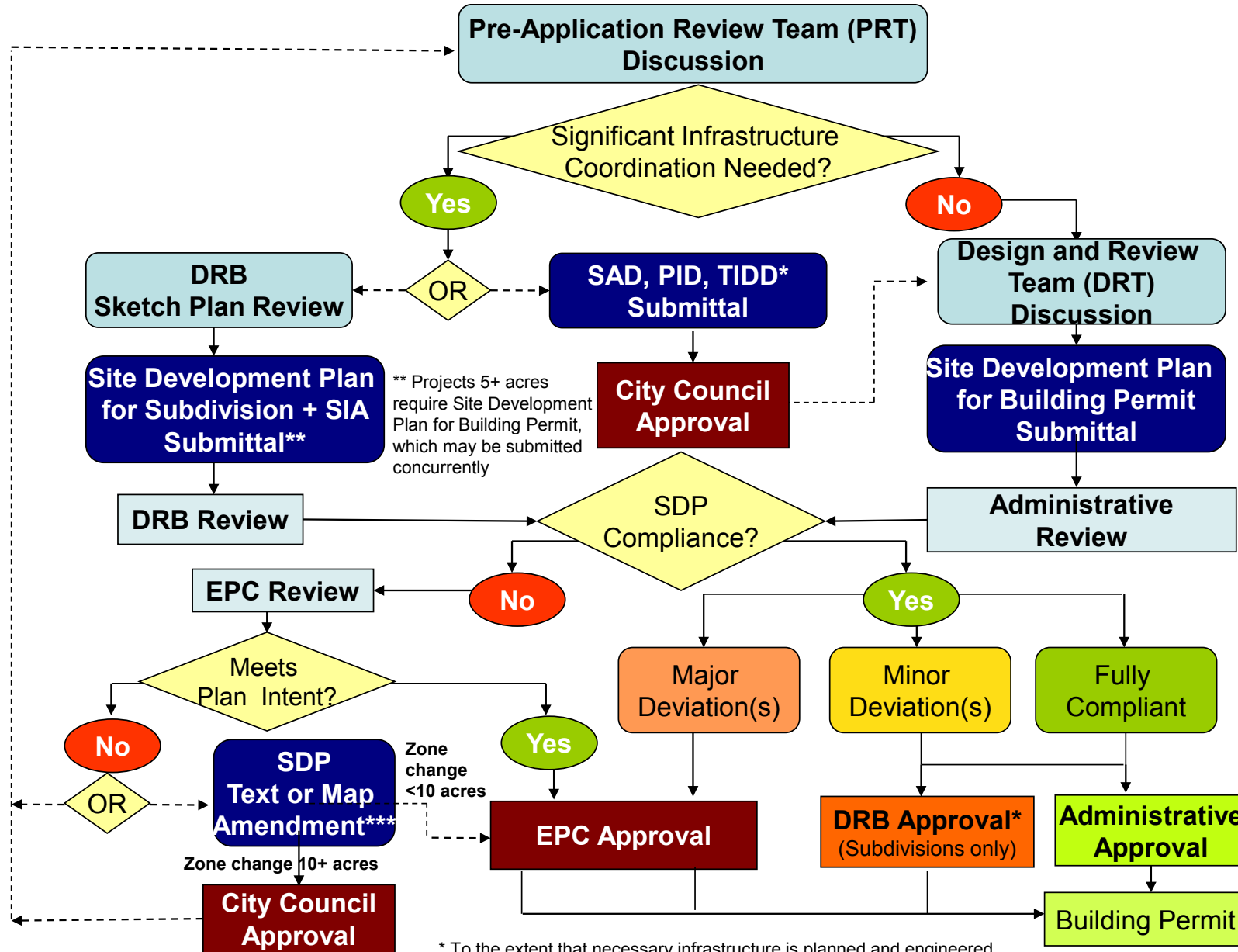

* To the extent that necessary infrastructure is planned and engineered
 *** Map amendment includes zone changes.

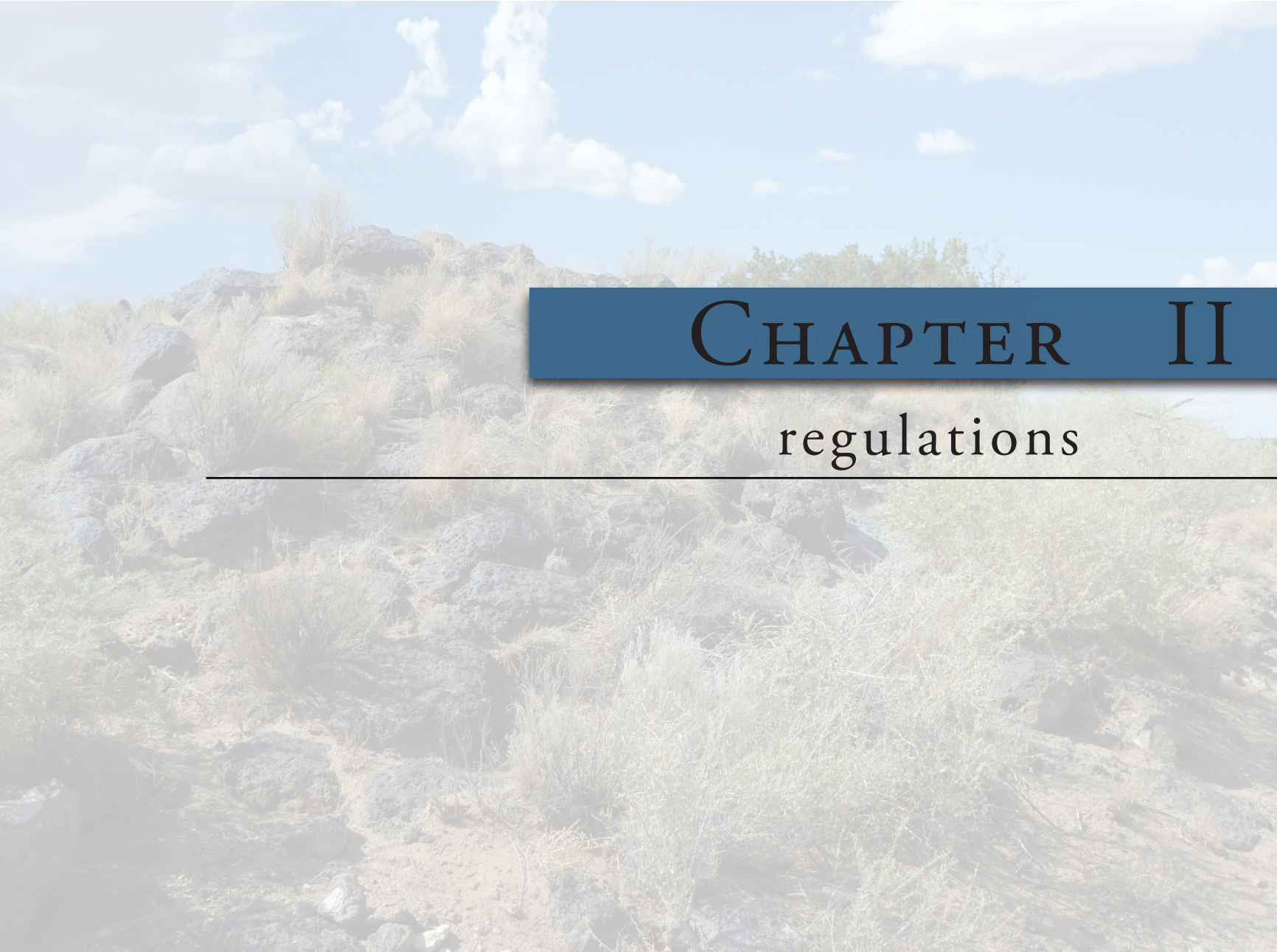

CHAPTER II

regulations

This Page Left Intentionally Blank



2.0 PLAN AUTHORITY

2.0 PLAN AUTHORITY

R
2

The Volcano Heights SDP (“The Plan” or “VHSDP”) is a Rank 3 plan that includes both regulations (i.e. law) and policies (i.e. guidance) as instruments to implement the goals, objectives, and policies of the Rank 1 Albuquerque/Bernalillo Comprehensive Plan, and more specifically the Rank 2 West Side Strategic Plan (WSSP).

2.1. Rank Plans

The City of Albuquerque uses a system of ranked plans, starting with the Rank 1 Albuquerque/Bernalillo County Comprehensive Plan, which sets the vision, goals, and overall policies from a City-wide perspective. There are also lower-ranked plans that must comply with the intent, policies, and goals of higher-ranked plans. Rank 2 Plans, such as the WSSP or the Arroyos Facility Plan, are exclusively policy documents that provide more detail and give more direction about large but distinct areas or facilities within Albuquerque. Rank 3 Plans, including Sector Development Plans (SDPs) such as this Volcano Heights SDP, take the most detailed look at smaller areas and can include both policy and regulations.

This Rank 3 VHSDP is intended to further and comply with the policies and intents of the adopted plans in **Table 2.1**. Where other plans and procedures are silent, the regulations and standards of this Plan shall prevail.

TABLE 2.1 – RELEVANT RANKED PLANS

RELEVANT RANKED PLANS	AREA	PLAN TYPE
Rank 1: Albuquerque / Bernalillo County Comprehensive Plan	Entire Albuquerque Area	Policy
Rank 2: Area / Facility Plans <ul style="list-style-type: none"> • West Side Strategic Plan • Facility Plan for Arroyos • CABQ Major Public Open Space Facility Plan • Trails and Bikeways Facility Plan • Facility Plan: Electric System Generation and Transmission (2010-2020) 	Relevant Albuquerque Areas, including Volcano Mesa	Predominantly Policy
Rank 3: Northwest Mesa Escarpment Plan (NWMEP)	Specific Area	Policy & Regulation

2.2. Northwest Mesa Escarpment Plan (NWMEP)

The Rank 3 NWMEP provides policy guidance and regulations for development within its boundaries. Adopted in 1988, it sets regulations and policies to control design, construction mitigation, view preservation, and drainage to protect sensitive lands in and around the Escarpment, parts of which became the Petroglyph National Monument.

The NWMEP designates three distinct areas and distinguishes regulations and policies accordingly: Conservation, Impact, and View. Volcano Heights is included in the NWMEP boundary and contains a small portion of Impact Area along the boundary of the Petroglyph National Monument to the east, while the rest of Volcano Heights is designated as View Area and subject to policies applicable to that designation. [See **Exhibit 2.1.**]

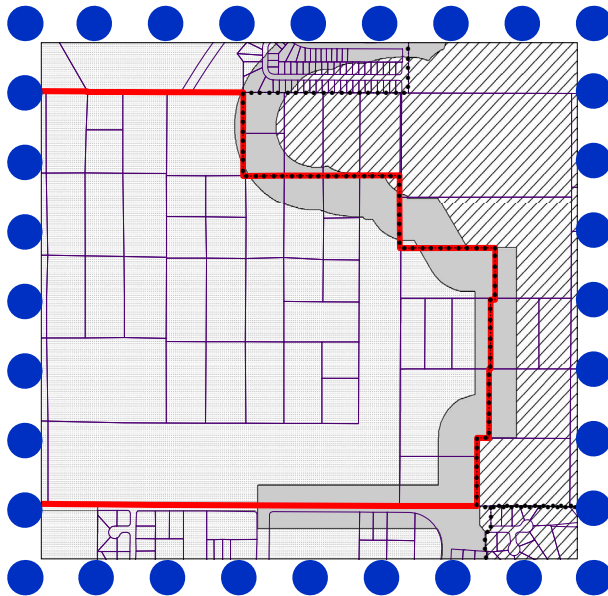

DETAIL: NWMEP IMPACT AREA IN VOLCANO HEIGHTS

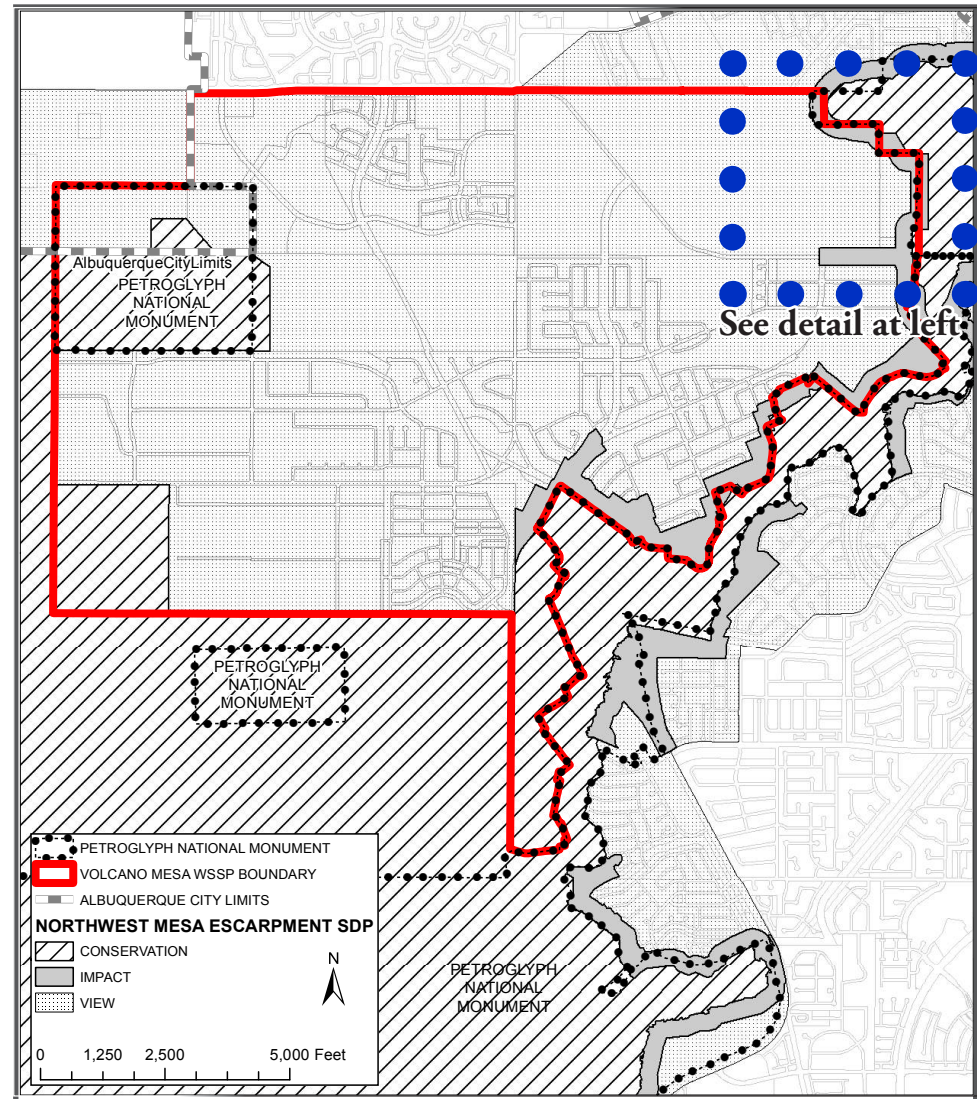
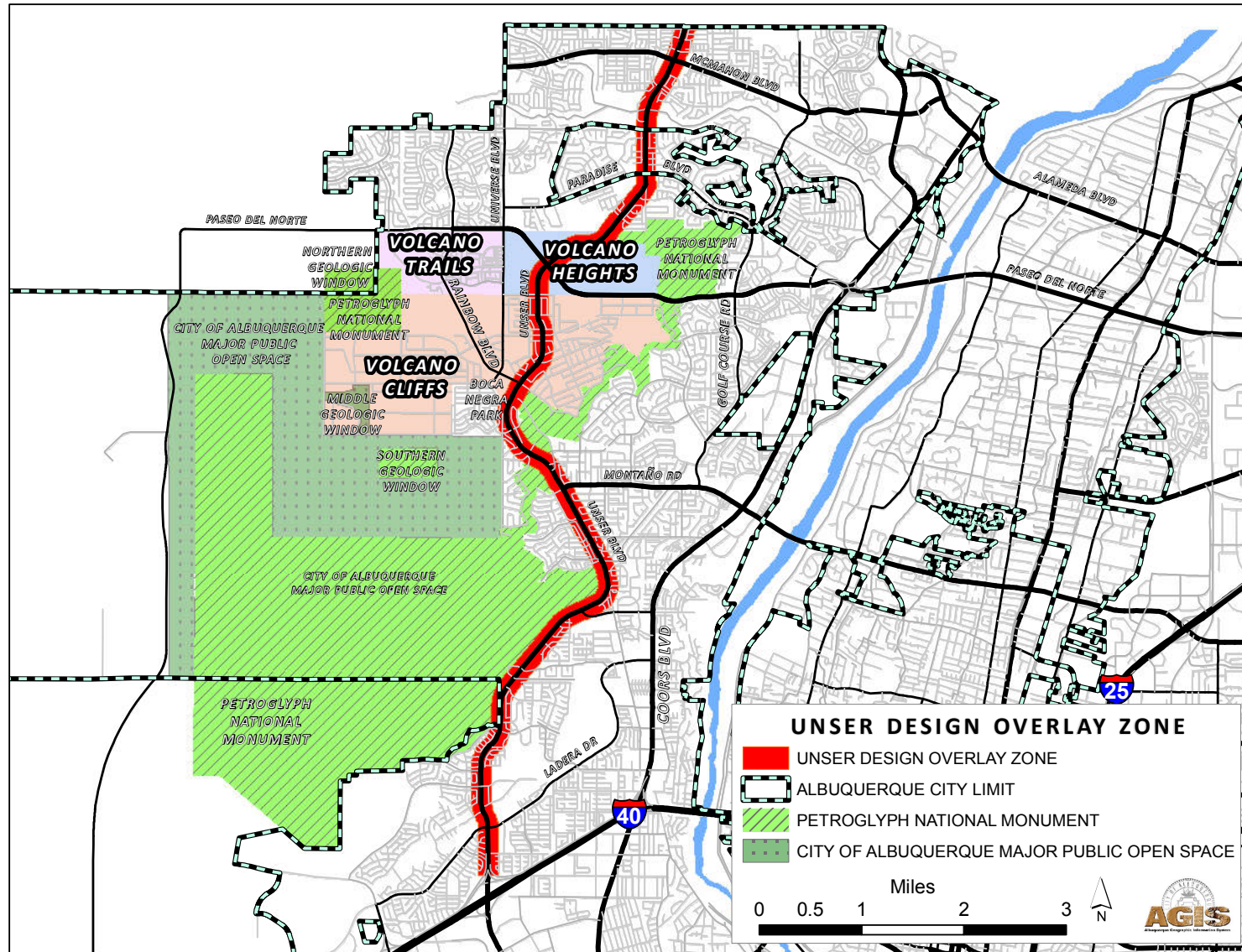

EXHIBIT 2.1 – NWMEP AND WSSP VOLCANO MESA AMENDMENT BOUNDARIES

2.0 PLAN AUTHORITY

R 2

- 2.2.1. Because the VHSDP and the NWMEP are both Rank 3 plans with overlapping boundaries, where a policy or regulation conflicts, the VHSDP prevails, unless otherwise stated in this Plan. Where one plan is silent, the policies/regulations of the other plan prevail.
- 2.2.2. Maximum heights by right in Town Center, Regional Center, Mixed-Use, and Neighborhood Transition Zones in Volcano Heights comply with the 40-foot maximum height allowed in the NWMEP View area, although the NWMEP measures from natural grade, and this Plan measures from approved grade, which in some cases may include a minimum amount of fill necessary for construction or to connect to infrastructure. Within Volcano Heights, the approved grade is used to govern structure height.
- (i) In order to balance the intent of respecting and protecting the fabric of unique cultural and geological features of this area with the intent of creating opportunities for a regional employment center and Major Activity Center, the VHSDP includes an optional bonus height system that allows **building height** above 40 feet for the Center and Mixed-Use Zones. Projects must meet additional criteria intended to provide commensurate benefits to both the natural and built environments as a trade-off for bonus height and density.
 - (ii) Portions of the Escarpment Transition Zone and Regional Center Zone that are also within the NWMEP Impact Area have **structure height** restrictions of 15 feet per the NWMEP, with the exception that heights shall be measured from approved grade. No variances or deviations shall be granted.
 - (iii) No bonus heights shall be granted within the Escarpment Transition or Neighborhood Transition Zones.
- 2.2.3. Color shall be regulated per this Plan. All structures and fences shall have exterior colors within a light reflective value of 20-50 percent. This restriction includes building walls and surfaces, roofs, mechanical equipment, and landscaping walls and fences [See **Section 7.5** starting on page 127 for building color restrictions. See **Section 9.7.4** starting on page 156 for walls and fences.] The intent is to minimize visibility for the purpose of views into the Plan area and maximize harmony with the natural environment within the Petroglyph National Monument, as the NWMEP intended.
- 2.3. Unser Boulevard Design Overlay Zone (DOZ):** The Unser Boulevard Design Overlay Zone, adopted in 1992, sets design regulations regarding signs along the Unser Boulevard corridor between I-40 and the Sandoval County line. [See **Exhibit 2.2** and **Exhibit 8.1** on page 135.]



Path: Q:\AGISFILE\PROJECTS\PetraMorris\THG-Nov11-VolcanoHeights\December2012\UnserDesignOverlayZone.mxd

EXHIBIT 2.2 – UNSER BOULEVARD DESIGN OVERLAY ZONE BOUNDARY

2.0 PLAN AUTHORITY

R 2

Enacted to preserve views of the Rio Grande Valley, the Sandia Mountains and the West Mesa Escarpment, it affects an area extending 500 feet on either side of the centerline of the roadway. The **DOZ** prohibits off-premise signs, portable signs, and signs that flash, move, or rotate. On-premise signs within the **DOZ** boundaries are generally limited to one wall or permanent free-standing sign per façade per business, the height and size of which are regulated based on façade area. For additional details and regulations, please consult the Unser Boulevard **DOZ**, available on the Planning Department's publications webpage: <http://www.cabq.gov/planning/publications/>

Because the VHSDP and the Unser Boulevard **DOZ** have overlapping boundaries, where a policy or regulation conflicts, the more restrictive prevails, except as noted in **Section 8.1.2** starting on page 134. Where one plan is silent, the policies/regulations of the other plan prevail.

- 2.4. City Zoning Code:** Development standards not addressed in this Plan shall be governed by the City Zoning Code to the extent they are not in conflict with the intent or provisions of this Plan. Where in conflict with this Plan, the development standards under City Zoning Code §14-16-3-18 General Building and Site Design Regulations for Non-Residential Uses, as amended, shall not apply to property within Volcano Heights.

- 2.5. City Subdivision Ordinance:** Development projects shall be subject to the City Subdivision Ordinance with the following exception: Right-of-way widths identified in **Section 10.6** starting on page 173 in this Plan shall prevail over those in the Subdivision Ordinance, where conflicting. Where the Subdivision Ordinance is silent in regard to street or streetscape standards in this Plan, the standards in this Plan apply.

- 2.6. Development Process Manual (DPM):** Development projects shall be subject to the City DPM. Where the DPM is silent in regard to street or streetscape standards in this Plan, the standards in this Plan apply.

- 2.7. Other City Regulations:** In order to meet the intent of development in this unique area, the provisions of this Plan, when in conflict, shall take precedence over those of other City codes, ordinances, regulations, and standards as amended except for the New Mexico Electrical Code, the New Mexico Electrical Safety Code and as noted elsewhere in this Plan. Where this Plan is silent, relevant City of Albuquerque codes, ordinances, regulations, and standards shall apply.



3.0 ADMINISTRATION

3.0 ADMINISTRATION

R

3

3.1. Applicability

- 3.1.1. The uses, buildings, and structures on all land within Volcano Heights shall conform to this Plan. **Table 3.1** shall determine which sections of the Plan apply to any proposed development based on the type and scope of the proposed development.
- 3.1.2. Provisions of this Plan are activated by “shall” when required, “should” when recommended, and “may” when optional.
- 3.1.3. Terms used throughout this Plan [as noted in bold] are defined in **Section 3.5** starting on page 40 of this Plan. Development within Volcano Heights shall be held to these definitions. For those terms not defined in this Plan, City Zoning Code §14-16-1-5 shall apply. Terms not defined in either section shall be accorded commonly accepted meanings. In the event of conflict, the definitions of this Plan shall prevail.
- 3.1.4. Where in conflict, numerical metrics shall prevail over graphic metrics.
- 3.1.5. In order to meet the intent of development in this unique area, the provisions of this Plan, when in conflict, shall take precedence over those of other City of Albuquerque codes, ordinances, regulations, standards, and plans as amended except as noted elsewhere in this Plan. Where this Plan is silent, relevant City of Albuquerque codes, ordinances, regulations, and standards shall apply. [See **Section 2.0 Plan Authority** starting on page 15].

3.1.6. Projects Subject to Review:

- (i) All private development and redevelopment projects are subject to administrative review by the Planning Department and/or official review by the Development Review Board (DRB) and/or Environmental Planning Commission (EPC) for compliance with the Plan. **Table 3.1** establishes the standards for the applicability of the various sections of this Plan to development and redevelopment projects.
- (ii) Applications for redevelopment projects shall be accompanied by a full-size set of the approved Site Development Plan for Building Permit or Subdivision, whichever is relevant. No building permit shall be approved unless it is consistent with the approved Site Development Plan and landscaping plan, particularly for any items contributing to a bonus height granted for buildings on the property. [See **Section 6.4** starting on page 111.]

3.2. Development Review and Approval Process

- 3.2.1. **Intent / Purpose:** In order to encourage and support development in Volcano Heights, review and **approval** of proposed projects should be conducted as speedily as possible. As such, this Plan proposes several opportunities to streamline **approval**, notwithstanding any efforts needed to coordinate infrastructure for development in the short-term.

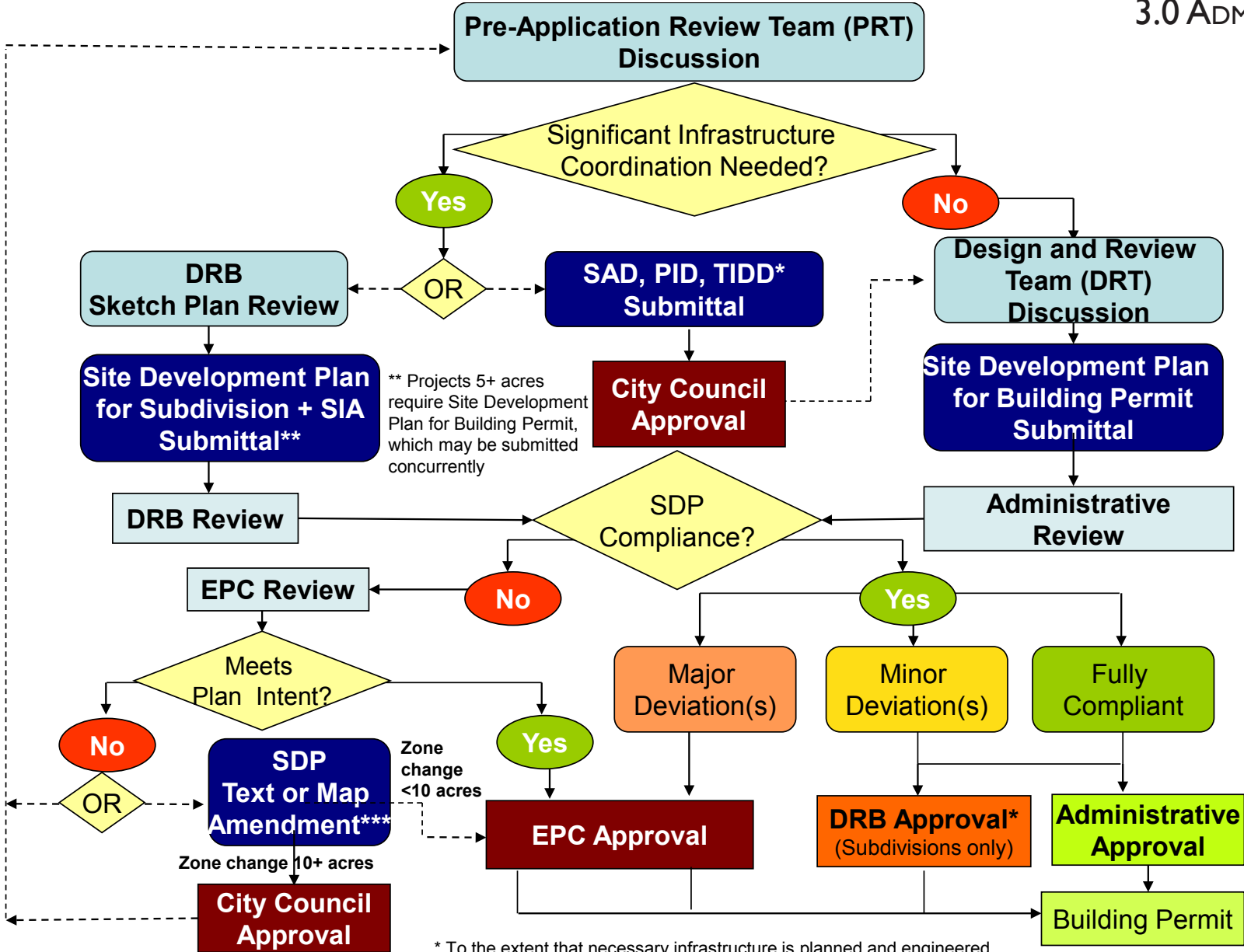

EXHIBIT 3.1 – VOLCANO HEIGHTS APPROVAL PROCESS DIAGRAM

CHAPTER II: REGULATIONS

3.0 ADMINISTRATION

R

3

TABLE 3.1 – APPLICABILITY OF PLAN SECTIONS BY DEVELOPMENT TYPE

PLAN SECTION	4.1 Land Use Table	5.X.2 Building Placement	5.X.4 Height Standards	5.X.6 Parking & Service	5.X.7.i Encroachments	5.X.7.iii Single-Family Buffer	5.X.9-12 Building Design Standards by Zone	6.0 General Site Development Standards	7.0 General Building Design Standards	8.0 Signage	9.0 Open Space Standards	9.6 Landscaping & Lighting	10.0 Street Standards	11.0 Streetscape Standards
TYPE OF DEVELOPMENT														
Residential (including single-family attached and detached buildings)														
New construction	X	X	X	X	X		X	X	X	X	X	X	X	X
Change of Use with no expansion of building	X			X					X	X		X		
Expansion of use/structure (any building addition, deck, porch, etc.)	X	X	X	X	X		X	X	X			X		
Expansion of use/structure (new accessory building/structure on the lot)	X	X	X		X		X	X	X			X		
Façade changes to existing buildings*														
‘A’ Street façade					X		X	X	X			X		
All other street façades					X		X	X	X					
Non-residential or Mixed Use														
New Construction	X	X	X	X	X	X	X	X	X	X	X	X	X	X
Renovations associated with change of use/expansion of use with no expansion of building	X			X	X				X	X				
Building Expansion														
0% - 49% increase in building square footage <i>(Standards in applicable sections shall apply only to the expansions)</i>	X	X	X	X	X	X	X	X	X	X	X	X		
50% or greater increase of building area <i>(Standards in applicable sections shall apply the entire building including retrofitting of the existing building if non-conforming)</i>	X	X	X	X	X	X	X	X	X	X	X	X	X	X

* Restuccoing with a color other than originally approved requires a permit in order to ensure compliance with color regulations per **Section 7.5** starting on page 127.

TABLE 3.1 – APPLICABILITY OF PLAN SECTIONS BY DEVELOPMENT TYPE (Cont'd)

PLAN SECTION	4.1 Land Use Table	5.X.2 Building Placement	5.X.4 Height Standards	5.X.6 Parking & Service	5.X.7.i Encroachments	5.X.7.iii Single-Family Buffer	5.X.9-12 Building Design Standards by Zone	6.0 General Site Development Standards	7.0 General Building Design Standards	8.0 Signage	9.0 Open Space Standards	9.6 Landscaping & Lighting	10.0 Street Standards	11.0 Streetscape Standards
Expansion of parking area only (not in conjunction with expansion of building or use)														
Up to 10 spaces				X				X	X	X		X		
11 or more additional spaces				X		X		X	X	X	X	X		
Façade changes to existing buildings*														
'A' Street façade					X		X	X	X	X		X	X	X
All other street façades					X		X	X	X	X		X		
Signage														
Modification of an existing sign where the cost of the modification is valued at <u>more than</u> 50% of the replacement value of the sign										X				
New sign or complete replacement of an existing sign										X				

[Amended November 5, 2014]

* Restuccoing with a color other than originally approved requires a permit in order to ensure compliance with color regulations per **Section 7.5** starting on page 127.

3.0 ADMINISTRATION

R

3

3.2.2. **Pre-Application Review Team (PRT)**

Discussions: Prior to submitting an application for a new development project, all potential **applicants** shall schedule and attend a discussion with the Planning Director or his/her designee. The Planning Department holds Pre-Application Review Team discussions weekly to provide informal guidance to property owners and/or developers during the conceptual design phase. This discussion will help determine whether major infrastructure will be needed, options for infrastructure planning and coordination, and opportunities for streamlining approvals. Based on conceptual plans, a staff planner may be assigned to the project to help **applicants** navigate necessary **approval** processes.

3.2.3. **Significant Infrastructure Coordination:**

Significant infrastructure is determined on a case-by-case basis but generally applies to a major street, drainage or utility facility, etc. that is necessary for the subject property as well as other nearby properties to develop. **Applicants** have two process options to coordinate **significant infrastructure**:

(i) A Site Development Plan for Subdivision may be submitted to the Development Review Board (DRB). This submittal includes a Subdivision Improvement Agreement, which documents financial guarantees of funds available to provide infrastructure. The developer must provide evidence that adequate and appropriate coordination with private utilities has occurred and may be required to show evidence of coordination with nearby property owners for other necessary infrastructure.

- a. Once approved by the **DRB**, Site Plans for Subdivision for projects less than 5 acres may proceed directly to building permit.
 - b. Subject to approval by the **DRB**, Site Plans for Subdivision 5 acres or greater shall require a Site Plan for Building Permit, eligible for Administrative Review and Approval per **Section 3.2.5** in this Plan. These site plans may be submitted concurrently.
- (ii) Applications for a **Special Assessment District (SAD)**, **Tax Increment Development District (TIDD)**, or **Public Improvement District (PID)** may be submitted to the City Council for **approval**, per the following City Ordinances.
- a. SAD: Albuquerque Code of Ordinances Section 6-8.
 - b. TIDD: Albuquerque Code of Ordinances Section 4-10.
 - c. PID: Albuquerque Code of Ordinances Section 6-9.
 - d. To the extent that these processes include planning for **significant infrastructure** and provide a financial mechanism to fund infrastructure improvements, applications that receive City Council **approval** are eligible for Administrative Approval of Site Development Plans for Building Permit.



3.2.4. **DRB Sketch Plat Review:** All **applicants** shall schedule and attend a discussion with the **DRB** before submitting a Site Development Plan for Subdivision or a Site Development Plan for Building Permit that requires infrastructure. The **DRB** holds weekly sketch plat reviews for no fee.

3.2.5. **Administrative Review and Approval:** Once infrastructure is either in place or coordinated with financial guarantees in place per **Section 3.2.3** of this Plan, Site Development Plans for Building Permit that fully comply with all standards of the Plan shall be processed administratively by the Planning Director or his/her designee and, if approved, proceed to **building permit**.

The Planning Department offers Design Review Team (DRT) appointments to applicants every other week to review projects within Sector Development Plan areas. Projects that comply with design regulations may receive a stamp from the **DRT** and proceed to building permit.

The Planning Director or his/her designee shall be responsible for the following:

- (i) Conducting Pre-Application Review Team Discussions;
- (ii) Assigning Staff to follow the project through the necessary **approvals**;
- (iii) Conducting **DRT** Discussions;
- (iv) Reviewing Site Plans for Building Permit for compliance with the intent, policies, and requirements of the Plan;
- (v) Determining whether a Site Plan for Building Permit deviates from any standard within the thresholds for:

- a. Minor Deviation per **Section 3.2.10** and **Table 3.2** below and therefore eligible for Administrative Approval;
 - b. Major Deviation per **Section 3.2.11** and **Table 3.3** below and therefore required to obtain approval by the **EPC**;
 - c. Non-compliance without meeting the intent of this Plan and therefore required to modify the Project or amend this Sector Development Plan per City Zoning Code §14-16-4-3; OR
 - d. Non-compliance yet still meeting the intent of this Plan and therefore eligible for approval by the **EPC** with an exception per **Section 3.2.13** in this Plan.
- (vi) Determining the public notice required for proposed projects, based on the **approval** process determined above
 - a. Public Notice for Site Plans for Subdivision per **Table 3.4** OR
 - b. Public Notice for Site Plans for Building Permit per **Table 3.5**.
 - (vii) Mailing Public Notice, at the applicant's expense, to relevant Property Owners as noted by (PO) in **Table 3.4** or **Table 3.5**;
 - (viii) Determining whether convening the Volcano Heights Review Team is appropriate;
 - (ix) Convening a Volcano Heights Review Team of relevant City staff and/or members of the public, if deemed appropriate;

3.0 ADMINISTRATION

R

3

- (x) Processing Site Development Plans for Building Permit that fully comply with the intent, policies, and requirements of the Plan;
- (xi) Approving minor deviations to Site Development Plans for Building Permit that comply with this Plan and all applicable City ordinances, as per **Section 3.2.10** in this Plan and City Zoning Code §14-16-2-22(A)(6), including Site Development Plans previously approved either by the **EPC** or administratively;
- (xii) Forwarding any major deviations to the **EPC** per **Section 3.2.11** starting on page 32 below; and
- (xiii) Forwarding any appeals of the decision of the Planning Director, **DRB**, or **EPC** to the City Council, per City Zoning Code §14-16-4-4.

3.2.6. Volcano Heights Review Team (VHRT)

- (i) As part of the Administrative Review Process, a Volcano Heights Review Team (“the Review Team” or VHRT) may be convened by the Planning Director or his/her designee for projects that require interpretation or discretionary judgment with respect to the project’s compliance with standards. This non-judicial Review Team shall be charged with working cooperatively and creatively with the applicant to solve problems and resolve conflicts regarding elements of a proposed development project that seem to meet the intent and policies of this Plan but face logistic challenges in meeting its numeric or text regulations or standards.

The VHRT may include, but is not limited to, the following City staff and/or agency representatives:

- Planning Director or his/her designee
- Staff Planner assigned to proposed project;
- City Planning & Zoning;
- City Hydrologist;
- City Department of Municipal Development (DMD);
- City Open Space Division;
- City Parks and Recreation;
- City Office of Neighborhood Coordination;
- Albuquerque-Bernalillo Water Utility Authority (ABCWUA);
- Albuquerque Metropolitan Area Flood Control Authority (AMAFCA)
- Mid-Region Council of Governments (MRCOG);
- Public Service Company of New Mexico (PNM);
- New Mexico Gas Company;
- Telecommunications companies;
- Adjacent property owners;
- Potential tenants;
- Neighborhood Association representatives;
- Merchants’ Associations representatives; and/or
- American Institute of Architects (AIA) representative(s) or other licensed design professional(s).

- (ii) City Planning shall designate a staff planner to specialize in this Plan and participate in all VHRT meetings.
- (iii) City Open Space Division shall be included in the review process where development is proposed within the Impact Area as defined by the NWMEP or within 200 feet of a significant rock outcropping as shown in **Exhibit 9.1** on page 147.
- (iv) As the Plan area develops, PNM shall be involved in all aspects of significant infrastructure development in order to allow for adequate utility planning and placement.

3.2.7. Development Review Board (DRB) Approval

The **DRB** shall be responsible for the following:

- (i) Conducting sketch plat reviews weekly;
- (ii) Reviewing/acting on Site Development Plans for Subdivisions that comply with this Plan, the **DPM**, and City ordinances;
- (iii) Reviewing/acting on minor deviations from any dimensional standard in a Site Development Plan for Subdivision per **Section 3.2.10** starting on page 30 of this Plan;
- (iv) Reviewing/acting on Site Development Plans for Building Permit that involve 4 or more feet of fill; and
- (v) Reviewing/acting on Site Development Plans for Building Permit that involve construction within the Impact Area as defined by the NWMEP. [See **Exhibit 2.1** on page 17.]

3.2.8. Environmental Planning Commission (EPC)

Approval: The EPC shall be responsible for the following:

- (i) Reviewing/approving Major Deviations from the standards beyond Minor Deviations as defined in **Table 3.2** below, which includes an opportunity for public review and comment at a public hearing. Major Deviation thresholds shall be allowed per **Table 3.3**. The **EPC** shall not approve projects that fail to meet the intent of this Plan.
- (ii) Reviewing/approving requests for adjustments to street standards beyond the thresholds specified in **Table 10.1** on page 168 that meet the intent of this Plan and can demonstrate policy justification for such requests to the satisfaction of the **EPC**.
- (iii) Reviewing/approving requests for **exceptions** to the regulations of this Plan that still meet the Plan's intent, per **Section 3.2.13** in this Plan.
- (iv) Reviewing/approving requests for zone changes 10 acres or less in size and reviewing/recommending to City Council **approval** or **denial** of zone change requests for more than 10 acres.

3.0 ADMINISTRATION

R

3

3.2.9. City Council Appeal and Approval

- (i) The City Council shall be the body to review/act on SAD, TIDD, and/or PID applications. [See **Section 3.2.3**.ii in this Plan.]
- (ii) Per City Zoning Code §14-16-4-1, the City Council shall be the final review and decision-making body in the following circumstances:
 - a. Zone Map amendments for projects 10 or more acres in size; and/or
 - b. Text amendments, including design regulations.
- (iii) The City Council shall be the final appeal body for proposed projects, per City Zoning Code §14-16-4-3.

3.2.10. Minor Deviations:

- (i) As defined in **Table 3.2**, the **DRB** shall have the authority to approve minor deviations from Site Development Plans for Subdivision and the Planning Director or his/her designee shall have the authority to approve minor deviations to Site Development Plans for Building Permit that:
 - a. Meet the intent of this Plan;
 - b. Do not materially change the circulation and building location on the site;
 - c. Do not increase the building area permitted;
 - d. Do not change the relationship between the buildings and the street, except in the case of preserving a rock outcrop, sensitive land, and/or culturally significant features;

- e. Do not allow greater height of any building without a commensurate benefit to the natural environment and built environment;
 - f. Do not eliminate regulations intended as protections for single-family development existing at the time of this Plan's adoption; and
 - g. Do not change any required element of the **zoning map** beyond the thresholds established in **Table 3.2** below.
- (ii) Minor deviations should be considered especially appropriate where they help to preserve a rock outcrop or other cultural or natural feature deemed significant by the City Open Space Division.
 - (iii) Any appeals shall be heard by the City Council, per City Zoning Code §14-16-4-4.

TABLE 3.2 – MINOR DEVIATION CRITERIA

STANDARD	MINOR DEVIATION ALLOWED	CRITERIA
Non-dimensional standard	Any non-dimensional standard deemed minor by the Planning Director or his/her designee.	<ul style="list-style-type: none"> Any deviation shall be based on specific development context that poses a challenge to meet the standards OR a demonstration that the proposed change improves the project's ability to meet the Plan's intent(s).
Site Development Standards		
Build-to zones/setbacks	<ul style="list-style-type: none"> No more than a 20% change in the maximum or minimum setback. On 'B' Streets, BTZ may be extended to 75 feet in the case of avoiding natural and/or culturally significant features. 	<ul style="list-style-type: none"> May be granted due to changes to the street cross sections; changes in the width of a sidewalk; changes to building placement to protect view corridors and/or enhance solar efficiencies; and/or changes to avoid major topography, road elevation changes, or natural and/or culturally significant features or sensitive lands, particularly rock outcroppings. May be granted to create a parking court, where appropriate. In no case shall the sidewalk be less than 6 feet in width.
Building Frontage	No more than a 15% reduction in the required building frontage along each block of an ' A ' Street.	<ul style="list-style-type: none"> Any reduction in the required building frontage shall be to accommodate porte cocheres for drop-off and pick-up.
Street screen	Waiver of street screen requirement along a ' B ' Street.	<ul style="list-style-type: none"> Requirement for a street screen may only be waived along a 'B' Street frontage of any interim surface parking lot (off-street) that is intended to be in-filled with a parking structure within 2 years. Applicant may be required to show financial records and/or sketch plats indicating intent and/or planning. In no case shall any portion of the surface parking have frontage along an 'A' Street without a required street screen. In no case shall the (off-street) surface parking lot be located at a street intersection for a minimum depth of 20' along each street (regardless of street type). Requirement may be waived where street screens are incompatible with utility infrastructure, particularly to address safety considerations for utility crews during maintenance and repair, as long as other satisfactory screening methods are employed or the applicant can demonstrate that the proposed use poses no negative visual impact to the built environment.
	Waiver of street screen requirement next to elevated roadways.	<ul style="list-style-type: none"> Where the roadway grade exceeds the approved property grade by more than 4 feet, the requirement for a street screen may be eliminated as long as the uses pose no negative visual impact from adjacent roadways and/or other methods of screening unsightly visual elements are employed. Requirement may be waived where street screens are incompatible with utility infrastructure, particularly to address safety considerations for utility crews during maintenance and repair.



TABLE 3.2 – MINOR DEVIATION CRITERIA (Cont'd)

STANDARD	MINOR DEVIATION ALLOWED	CRITERIA
Building Design Standards	Any dimensional standard change (increase or decrease) up to 10%.	<ul style="list-style-type: none"> Any deviation shall be based on specific development context that poses a challenge to meet the standards OR a demonstration that the proposed change improves the project's ability to meet the Plan's intent(s).
	Any non-dimensional standard deemed minor by the Planning Director or his/her designee.	<ul style="list-style-type: none"> Any deviation shall be based on specific development context that poses a challenge to meet the standards OR a demonstration that the proposed change improves the project's ability to meet the Plan's intent(s).
Off-street Parking Spaces	Additional spaces may be added where limits are placed on conditional uses.	<ul style="list-style-type: none"> Applicant shall provide evidence of no adverse effects on surrounding uses. One or more of the following shall be required, subject to the approval of the Planning Director or his/her designee: <ul style="list-style-type: none"> Parking shall be fully screened via landscaping, wall, and/or fence per Section 6.8.4 starting on page 123 in this Plan. Parking shall be broken up with landscaping every 10 spaces and as otherwise regulated per City Zoning Code §14-16-3-1. Pedestrian walkways shall be included to front entrances, per City Zoning Code § 14-16-3-1(H).

3.2.11. Major Deviations:

- (i) The **EPC** shall have the authority to approve major deviations, as defined in **Table 3.3**, that:
 - a. Meet the intent of this Plan;
 - b. Do not materially change the circulation and building location on the site;
 - c. Do not increase the building area permitted;
 - d. Do not change the relationship between the buildings and the street, except in the case of preserving a rock outcrop, sensitive land, and/or culturally significant features;

- e. Do not allow greater height of any building without a commensurate benefit to the natural environment and built environment;
- f. Do not eliminate regulations intended as protections for single-family development existing at the time of this Plan's adoption; and
- g. Do not change any required element of the **zoning map** beyond the thresholds established in **Table 3.3**.
- (ii) Major deviations should be given special consideration where they help to preserve a rock outcrop or other cultural or natural feature deemed significant by the City Open Space Division.

TABLE 3.3 – MAJOR DEVIATION CRITERIA

STANDARD	MAJOR DEVIATION ALLOWED	CRITERIA
Site Development Standards		
Build-to Zones/Setbacks	A change in the maximum or minimum setback between 20-50%. In the case of avoiding natural and/or culturally significant features or for the purpose of utility use, a greater allowance is permitted on a case-by-case basis.	<ul style="list-style-type: none"> Changes to the build-to zones and setbacks may only be due to any changes to the street cross sections, changes due to utility use, changes in the width of a sidewalk, and/or changes to building placement to protect view corridors and/or enhance solar efficiencies. In no case shall the sidewalk be less than 6 feet in width.
Building Frontage	A reduction in the required building frontage along each block of an 'A' Street between 15-30%.	<ul style="list-style-type: none"> Any reduction in the required building frontage shall be to accommodate porte cocheres for drop-off and pick-up.
Building Design Standards	Any dimensional standard change (increase or decrease) between 10-40%.	<ul style="list-style-type: none"> Any change shall be based on specific development context that poses a challenge to meet the standards OR a demonstration that the proposed change improves the project's ability to meet the Plan's intent(s).
	Any non-dimensional standard deemed major by the Planning Director or his/her designee.	<ul style="list-style-type: none"> Any change shall be based on specific development context that poses a challenge to meet the standards OR a demonstration that the proposed change improves the project's ability to meet the Plan's intent(s).

- (iii) Any appeals shall be heard by the City Council, per City Zoning Code §14-16-4-4.

3.2.12. **Non-compliance:** This Plan distinguishes projects that meet the intent of this Plan, as determined by the Planning Director or his/her designee, from those that do not.

- (i) Projects that meet the intent of this Plan but require deviations beyond those considered Major per **Table 3.3** in this Plan shall follow one of the relevant processes below:

- a. Request and justify a variance because of unique parcel conditions through the process outlined in City Zoning Code §14-16-4-2 OR
- b. Request and justify an **exception** to a design standard (e.g. Site Development or Building Design Standards) per **Section 3.2.13** in this Plan.

- (ii) Projects that do not meet the intent of this Plan shall require either modification to the project or amendment of this Plan, per **Section 3.3** of this Plan and City Zoning Code §14-16-4-3.

3.2.13. Exceptions from Design Standards in this Plan, Subdivision Ordinance, and/or DPM

- (i) As long as a proposed project meets the intent of this Plan, the **EPC** shall be authorized to approve Site Development Plan submittals with appropriate **exceptions** to adopted standards and regulations, provided a project meets at least one of the following conditions, as justified by the **applicant**:
 - a. The project includes **exceptional** civic, architectural, or environmental design. These design elements should provide a benefit to the City, **adjacent** property owners, and/or the built or natural environment that justifies the requested **exception** to the satisfaction of the **EPC**.
 - b. The **exception** will help to preserve and/or enhance significant views, **rock outcroppings**, or other natural features.
 - c. The **exception** will help to coordinate and/or enhance development or improvements on **adjacent** properties and/or accommodate utility use or public utility structures.
 - d. The **exception** is needed to accommodate a **major employer**. Such an exception may be subject to a development agreement with the City that includes clawback provisions in the event that the major employer leaves the Plan area within 5 years of project approval.

- (ii) In order to justify requests for **exceptions**, the **applicant** shall submit sufficient design sketches, photographs, and other detailed information as may be necessary to demonstrate the case and solution requested for an exception to the adopted regulations.
- (iii) Site Development Plans may require additional analysis and/or documentation, such as, but not limited to: site elevations, site sections, and building heights showing impacts to views and/or relationship to nearby **sensitive lands**.

3.2.14. **Review of Phased Projects:** To minimize review steps for phased projects, the **DRB** may approve a Site Development Plan for Subdivision for all phases provided that the **applicant** submits drawings that depict the initial phase as well as all future phases. The Site Development Plan is valid for seven years from the date of the **approval** and may be amended administratively per City Zoning Code §14-16-2-22.

3.3. **Amendments to the Sector Development Plan and/or Zoning Map:** Amendments and/or changes to the **zoning map** shall be considered by the **EPC** for sites 10 acres or less. For sites more than 10 acres and for all text amendments, the **EPC** is the recommending body, and the City Council is the decision-making body per City Zoning Code §14-16-4-1.

3.4. Public Notification

- 3.4.1. Notification for Site Plans for Subdivision shall be required as per **Table 3.4**.
- 3.4.2. Notification for Site Plans for Building Permit shall be required as per **Table 3.5**.
- 3.4.3. **Applicant Responsibilities:** When required (as noted with “NA” in **Table 3.4** or **Table 3.5**), the **applicant** shall give written **notification** of the Application for Site Development Plan to the relevant groups registered with the Office of Neighborhood Coordination. This may include recognized **Neighborhood Associations**, Neighborhood Coalition, non-recognized neighborhood organization, homeowner association, property owner association, or merchant association that covers, abuts, or is across the public **right-of-way** (ROW) from the project site.
- (i) The Office of Neighborhood Coordination (ONC) shall provide the applicant with a complete list of the names and addresses for all people who require notification, including any interested parties in the area who have registered with ONC to receive notice. The applicant shall not be held responsible for notifying people who are not on the ONC list.
- (ii) Notification shall include a reduced version of the proposed Site Development Plan, including the Landscape Plan; the date, time, and location of the **DRB** or **EPC** hearing; contact information for the applicant; and the name, e-mail, and phone number of the Staff Planner.

- (iii) Notification shall be sent by certified mail, return receipt requested, and postmarked at least fifteen (15) days in advance of the hearing.
- (iv) The **applicant** shall give copies of the ONC **notification** list and proof of mailings to the Approval Body for the hearing record. Failure by the **applicant** to show proof of **notification** shall be grounds for a deferral of the applicant’s proposal at the Hearing until proper proof of **notification** is provided by the **applicant**.

- 3.4.4. **Planning Director Responsibilities:** When required (as noted with “PO” in **Table 3.4** or **Table 3.5**), the Planning Director or his/her designee shall provide mailed **notification** to property owners within one hundred (100) feet of the boundaries of the proposed project site, excluding public rights-of-way, at the applicant’s expense.

Notification shall be postmarked a minimum of fifteen (15) days prior to the hearing and shall include reduced copies of the proposed Site Development Plan, the Landscape Plan, and contact information for the Planning Department and the **applicant**.

TABLE 3.4 – APPROVAL PROCESS AND NOTIFICATIONS: SITE PLANS FOR SUBDIVISION

ZONES	PROPOSED PROJECT	COMPLIANCE	APPROVAL PROCESS			NOTIFICATION	
			DRB	EPC	NA	PO	NR
Transition Zones	Any Project < 5 acres	Fully Compliant	DRB				NR
		Minor Deviation(s)	DRB				NR
		Major Deviation(s)		EPC	NA	PO	
	Any Project 5+ acres	Fully Compliant	DRB				NR
		Minor Deviation(s)	DRB		NA	PO	
		Major Deviation(s)		EPC	NA	PO	
Center Zones + VHMx	Any Project < 5 acres	Fully Compliant	DRB				NR
		Minor Deviation(s)	DRB				NR
		Major Deviation(s)		EPC	NA	PO	
	Any Project 5+ Acres	Fully Compliant	DRB				NR
		Minor Deviation(s)	DRB				NR
		Major Deviation(s)		EPC	NA	PO	

Approval Process Abbreviations

DRB = Development Review Board

EPC = Environmental Planning Commission

Notification Abbreviations

NA = Neighborhood Associations *(Includes relevant Merchants Associations registered with the Office of Neighborhood Coordination. Notice shall be the responsibility of the applicant.)*
PO = Property Owners within 100 feet *(Notice shall be the responsibility of the Planning Director or his/her designee at the applicant's expense.)*
NR = Not Required

TABLE 3.5 – APPROVAL PROCESS AND NOTIFICATIONS: SITE PLANS FOR BUILDING PERMIT

ZONES	PROPOSED PROJECT	COMPLIANCE	APPROVAL PROCESS			NOTIFICATION	
Transition Zones	Residential Project < 5 acres	Fully Compliant	AA				NR
		Minor Deviation(s)	AA	VHRT			NR
		Major Deviation(s)			EPC	NA	PO
	Residential Project 5+ acres OR Project with Non-residential Component (any size)	Fully Compliant	AA	VHRT			NR
		Minor Deviation(s)	AA	VHRT		NA	PO
		Major Deviation(s)		VHRT	EPC	NA	PO
Center Zones + VHMX	Any Project < 5 acres	Fully Compliant	AA	VHRT			NR
		Minor Deviation(s)	AA	VHRT			NR
		Major Deviation(s)		VHRT	EPC	NA	PO
	Any Project 5+ Acres	Fully Compliant	AA	VHRT			NR
		Minor Deviation(s)	AA	VHRT			NR
		Major Deviation(s)		VHRT	EPC	NA	PO

Approval Process Abbreviations

AA = Administrative Approval

 VHRT = Volcano Heights Review Team
 =
 EPC = Environmental Planning Commission

Notification Abbreviations

NA = Neighborhood Associations *(Includes relevant Merchants Associations registered with the Office of Neighborhood Coordination. Notice shall be the responsibility of the applicant.)*
 PO = Property Owners within 100 feet *(Notice shall be the responsibility of the Planning Director or his/her designee at the applicant's expense.)*
 NR= Not Required



CHAPTER II: REGULATIONS

3.0 ADMINISTRATION

R

3

TABLE 3.6 – APPROVAL PROCESS BY DEVELOPMENT TYPE

TYPE OF REQUEST	Administrative Review (PRT/DRT)	Administrative Approval (AA)	DRB Decision	EPC Decision	City Council Decision	Building Permit (Front Counter)	APPLICABLE SECTIONS/CRITERIA
1. Ordinary building maintenance (includes changes to the exterior and/or interior)						X	<ul style="list-style-type: none"> Interior changes may require building, electrical, and/or other city permits Exterior changes affecting more than 120 SF require a building permit.
2. Renovation or alteration of a building interior with no exterior façade changes						X	<ul style="list-style-type: none"> Interior changes may require building, electrical, and/or other city permits.
3. Renovation, alteration of, or addition to an existing building	X	X				X	<ul style="list-style-type: none"> Any decision on Major Deviations from dimensional elements limited to building height and building setbacks shall be made by the EPC.
4. Demolition of a building	X					X	<ul style="list-style-type: none"> Requires demolition permit from the City.
5. New construction with < 4 ft. fill NOT requiring significant infrastructure	X	X		Major Deviat.		X	
6. New construction with < 4 ft. fill requiring significant infrastructure	X		X	Major Deviat.		X	
7. New construction with 4+ ft. fill	X		X	Major Deviat.		X	<ul style="list-style-type: none"> Requires sign-off from City hydrologist.
8. Construction of a parking garage	X	X		Major Deviat.		X	<ul style="list-style-type: none"> Building Design Standards shall apply.
9. Construction of a new surface parking lot or expansion of an existing surface parking lot	X		X	Major Deviat.		X	

Notes:

1. Appeals per City Zoning Code §14-16-4-4
2. Deviat. = Deviation [See **Table 3.2** and **Table 3.3**]

TABLE 3.6 – APPROVAL PROCESS BY DEVELOPMENT TYPE (Cont'd)

TYPE OF REQUEST	Administrative Review (PRT/DRT)	Administrative Approval (AA)	DRB Decision	EPC Decision	City Council Decision	Building Permit (Front Counter)	APPLICABLE SECTIONS/CRITERIA
10. Renovation associated with change of use within an existing building or structure (with no exterior façade changes)	X	X				X	
11. New sign or alteration of an existing sign	X	X				X	<ul style="list-style-type: none"> Sign permits shall be required for all new and altered signs within any character zone. Signs may be approved administratively for all signs that conform to Sign Standards.
12. Master Sign Plan approval	X		X	Major Deviat.			<ul style="list-style-type: none"> See #11 above.
13. Character zone boundary change request	X			Recomm.	X		<ul style="list-style-type: none"> All requests to change the underlying zoning boundaries shall be processed as an SDP Zoning Map Amendment per City Zoning Code §14-16-4-3. Zone changes shall not eliminate any Character Zone from the Plan area or change the overall boundary of the Plan area.
14. Request to change zoning standards or design standards (i.e. text amendment)	X			Recomm.	X		<ul style="list-style-type: none"> All requests to change the underlying zoning and/or design regulations shall be processed as an SDP text amendment per City Zoning Code §14-16-4-3.

Notes:

1. Appeals per City Zoning Code §14-16-4-4
2. Deviat. = Deviation [See **Table 3.2** and **Table 3.3**]
3. Recomm. = Recommendation to the City Council

3.0 ADMINISTRATION

R

3

3.5. Definitions

The following definitions shall apply within Volcano Heights. For those terms not defined in this Plan, City Zoning Code §14-16-1-5 shall apply. In the event of conflict, the definitions of this Plan shall prevail. Where used elsewhere in this Plan, these terms appear in bold.

- A' Street:* A street designation in this Plan used to denote pedestrian-friendly streets with few or no curb cuts, particularly suited to retail opportunities.
- Abutting:* The condition under which two properties touch, without separation by a public **right-of-way (ROW)**.
- Accessory Building:* Defined per City Zoning Code §14-16-1-5, accessory buildings do not count as **buildings** for the purposes of **building frontage** or Site Development Standards in this Plan. Accessory buildings shall conform to the Building Design Standards in this Plan.
- Accessory Use:* A use that is appropriate, subordinate and customarily incidental to the primary use of the lot.
- Adjacent:* The condition under which two properties are next to each other, whether **abutting** or separated from a public **ROW**.
- Alley:* A thoroughfare designated by the City as public **ROW**, which affords secondary means of access to an **abutting** property.



Mezzanine on the West Side

Amphitheater:

An open-air venue for entertainment, typically comprised of a stage facing a sloping, semi-circular seating gallery. The scale should complement surrounding development. Where located within 500 feet of existing residential uses, special design measures, such as locating the stage so sound is directed away from homes or employing berms or walls to redirect sound as necessary, shall be taken to reduce ambient impacts off-site. Amphitheaters shall comply with the City noise control ordinance [Article 9 of Building and Safety: ROA 1994 Sec. 9-9].

Ancillary Structure:

A standalone structure with at least one open side located in an open space area. While it may include minor commercial uses, such as small food or news vendors, it is primarily intended to serve as a civic element for general public use to support and complement more passive activities. Ancillary structures may take the form of a pavilion, pergola, or kiosk. The style should complement surrounding buildings while remaining clearly subordinate to them in mass and scale. Ancillary structures do not count as buildings for the purpose of building frontage or Site Development Standards in this Plan but shall conform to the Building Design Standards in this Plan.

Angled Parking:

See **Parking, Angled**.

Appeal Process:

The process by which a land-use decision made by the DRB, EPC, or Planning Director may be challenged.

3.0 ADMINISTRATION

Applicant: A person applying for Site Development Plan **approval**. The person may be the property owner or owner’s agent.

Approval: An action taken by the Planning Director (or his/her designee) or EPC issuing a **Notice of Decision (NOD)** or by the DRB signing and dating a Site Development Plan as **approved**.

Approved Grade: The grade approved by the City Hydrologist that meets the requirements of the City drainage ordinance, provides sufficient conditions to link to utilities, but imports the least amount of fill. Approved grade may or may not be the same as the nearest roadway grade.

Articulation: A means of breaking up large expanses of blank wall both horizontally and vertically by adding changes of relief (i.e. how far a portion of the façade projects from or is recessed into the main façade surface), alternating building materials, and/or the placement of windows, **portals**, and other exterior features.

Attics / Mezzanines: The interior part of a **building** contained within a pitched roof structure or a partial story between two main stories of a building.

Auto-related Sales and Service Uses: Establishments that provide **retail sales** and services related to automobiles including, but not limited to, cars, tires, batteries, gasoline, etc.

Auto-oriented: A term describing those aspects of a project intended primarily for the benefit of vehicle access, amenities, and service, including but not limited to drive-through lanes, drive-up windows, queuing, parking, **alleys**, loading areas, etc.

Awning: A decorative feature extending from the exterior of a **building** that may serve as a shelter from the sun, rain, or wind.

‘B’ Street: A street designation in this Plan that denotes an **auto-oriented** street that provides vehicle access to parking, services areas, etc.

Block Size: Block size is measured between centerlines of the vehicular streets that frame the block, which is defined per City Zoning Code §14-16-1-5.

Bikeway: Any bicycle lane, bicycle route, and/or bicycle trail.

Build-to Zone (BTZ): The area within which the principal building’s front façade is to be built. (Porches and courtyards do not count as principal façades.) The BTZ is measured from the required minimum setback. Where appropriate, parking is allowed within the BTZ, given the required screening.

Building: Any structure used or intended for supporting or sheltering any use or occupancy that is entirely separated from any other structure by space or by walls in which there are no common doors, windows, or similar openings; is covered by a roof; and forms an enclosed space. Buildings generally enclose primary uses of the site, as opposed to **accessory buildings**, which enclose accessory (i.e. secondary or auxiliary) uses.

Building Façade Line: The vertical plane along a lot where the building’s front façade is actually located.

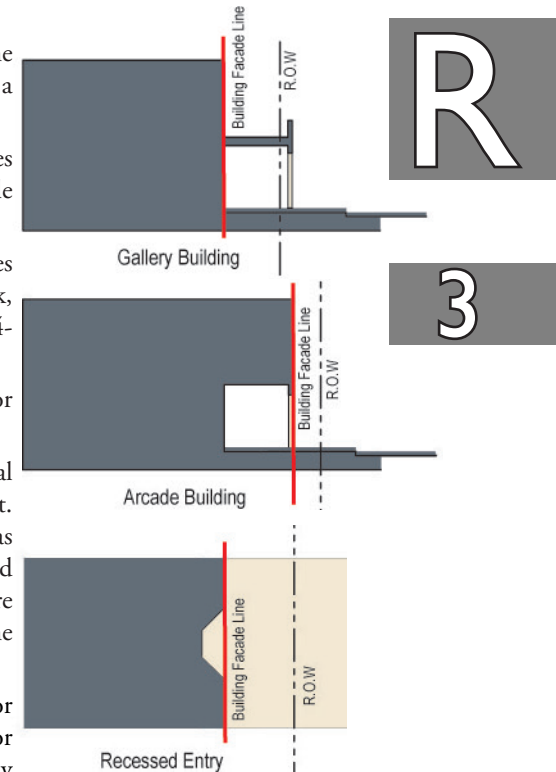

Sample Building Façade Lines

CHAPTER II: REGULATIONS

3.0 ADMINISTRATION

R

[Amended November 5, 2014]

3

Building Frontage:

The percentage of ground floor façade width located within the **Build-to Zone** as a proportion of the total building façade along an **'A'** or **'B'** Street. **Civic space** that meets the criteria in **Table 9.4**, including **parks**, **plazas**, **forecourts**, and **paseos**, shall be considered as buildings for the calculation of building frontage. [See calculation diagram.]

Building Height:

The height of a **building** measured from approved grade to the eave line in the case of a pitched roof or to the roof line in the case of a **parapet**. See also **structure height**.

Building Permit:

An official certificate of Entitlement issued by the City to an **applicant** in order to construct, enlarge, or alter a structure.

Business Improvement District (BID):

Business Improvement Districts (BIDs) are created by petition of at least ten or more business owners comprising at least 51% of the total business owners in the proposed district. Upon receipt of the petition, a municipality typically passes an ordinance creating the district and establishing the time and terms for paying the BID fee, which could be assessed as part of property taxes or paid annually by tenants. The municipality appoints a management committee, typically an existing revitalization nonprofit or a committee of nominees submitted by business owners, to manage collected fees and act as the legal entity to provide ongoing maintenance, services, and liability for a self-defined area. BIDs often employ a property manager that can act as a recruiting, marketing, and brokering agent for the district. [See also State of New Mexico BID Act, Sections 3-63-1 to 3-63-16 NMSA 1978.]

Bus Rapid Transit (BRT):

A public transportation system with some dedicated infrastructure and additional resources that enables service that is timely and more efficient than an ordinary bus line can provide. These systems approach the service quality of rail transit with the cost savings and flexibility of bus transit.

Center Zones:

Character Zones within Volcano Heights meant to provide gravity to hold together surrounding development. Center Zones are intended to have the most dense, urban, walkable built environment and the most intense activity, particularly for pedestrians. In this Plan, Center Zones include Town Center, Regional Center, and Village Center zones.

Character Zone:

A zone within Volcano Heights that creates an urban form distinct from other zones in the Plan area. Character Zones are identified in the zoning map in **Section 4.1** starting on page 57.

Civic Space:

See **Open Space, Civic**.

Colonnade:

A row of regularly spaced columns supporting a major horizontal element above.

Commercial Ready:

A space constructed at a minimum ground floor height as established by character zone that may be used for non-commercial uses and/or be converted into retail/commercial use. The space must comply with all building and construction codes for retail use in place at the time of site plan **approval**. Commercial-ready spaces are intended to provide additional flexibility to use space according to market demand.

Commercial Surface Parking Lot:

Typically for-fee parking as the primary use of the property. This does not include commercial garages or required off-street parking that supports an associated, primary commercial use located on the same property, such as store or office parking.

[Amended November 5, 2014]

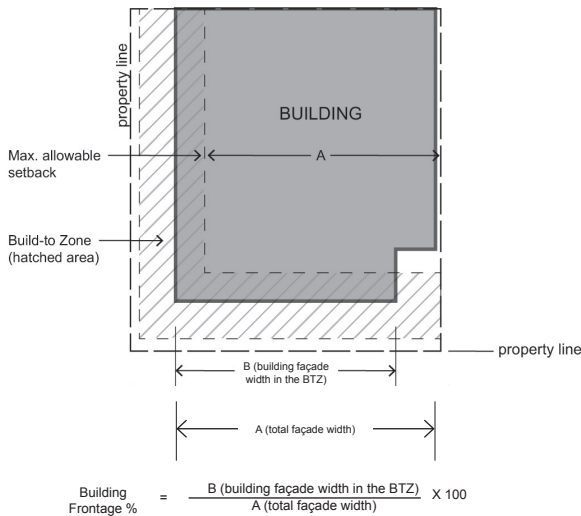

Building Frontage Calculation

3.0 ADMINISTRATION

Community Garden: A small- to medium-size garden cultivated by members of an area for small-scale agricultural uses for the benefit of the same people. It may consist of individually tended plots on a shared parcel or may be communal (everyone shares a single plot).

Cornice: The uppermost section of the trim along the top of a wall or just below a roof.

Courtyard: A landscaped open space in the center of the block with no street frontage, surrounded by walls or buildings on all sides. It shall be large enough to allow for public activities and have sunlight during midday. It should be designed to connect to **adjacent buildings** or to the public sidewalk through a pedestrian passage and should incorporate **water harvesting**.

Denial: A refusal by any relevant **approval** body to approve an application because of non-compliance with the intent, requirements, regulations, and/or standards of a Sector Development Plan and/or applicable City codes.

Development Review Board (DRB): A 5-member board of City staff (designees for the Planning Director, Parks and Recreation, and ABCWUA; City Engineer; and Traffic Engineer) charged with administering the Subdivision Ordinance and granting **approval** or **denial** of Site Development Plans. [DRB Hearings are weekly.]

DRB Hearing: Hearings held to review Site Development Plans and take public comment on proposed projects.

EIFS: Exterior Insulating Finishing System, a relatively inexpensive building material limited by the Building Design Standards in this Plan.

Encroachment: Any structural or non-structural element such as a sign, **shade structure**, canopy, terrace, or balcony, that breaks the plane of a vertical or horizontal regulatory limit, extending into a setback, into the public ROW, or above a height limit. Encroachments are allowed via revocable permit and subject to license and fee restrictions per the DPM, Chapter 8.

Escarpment: A linear, steeply sloped landform or cliff-like area that separates flatter terrain above and below it. The Northwest Mesa escarpment consists of lands in excess of 9% slopes covered with basalt boulders, which form the division between the mesa top above and the edge of the former Rio Grande floodplain below. Most of the escarpment is protected from development as part of the Petroglyph National Monument. The escarpment generally provides a visual demarcation between built and natural environments and between public and private lands.

Exception: In addition to exceptions allowed by City Zoning Code §14-16-4-2, this Plan defines criteria under which a project can request an exemption from a regulation in this Plan. [See **Section 3.2.13** starting on page 34.]



Action Buzz Community Garden



Sawmill Courtyard



Brickyard District Courtyard

3.0 ADMINISTRATION

R

3



Forecourt in East Downtown



Gallery in Downtown

Exceptional Project:

Any project incorporating elements of exceptional civic, architectural, or environmental design that benefit the City, **adjacent** properties, and/or the built or natural environments, including outstanding public spaces, innovative buildings or structures, or forward-thinking design for sustainability and/or context-sensitive design. Important benefits to the natural environment relevant to this Plan include habitat preservation; interpretation and/or preservation of cultural and/or archaeological resources; or sustainability, **Low-Impact Design**, or **water harvesting**.

Façade:

Any separate external face of a **building**, including **parapet** walls and recessed walls. Where separate faces are oriented in the same direction, or in directions within 45 degrees of one another, they are considered part of a single façade.

First Flush Storm Event:

The stormwater runoff during the early stages of a storm that can deliver a potentially high concentration of pollutants due to the washing effect of runoff from impervious areas directly connected to the storm drainage system.

Forecourt:

Similar to a **courtyard** but located in the front of a **building** such that the forecourt is surrounded on two or three sides by wings of the building. See also **parking court**.

Frontage:

See **building frontage**.

Gallery:

An extension of the main façade of the **building** at or near the front property line. The gallery may overlap the public sidewalk, subject to **encroachment** license and fees per the DPM, Chapter 8.

Gross Square Feet (GSF):

Corresponds to the definition of Gross Floor Area per City Zoning Code §14-16-1-5. (GSF = Net Usable Area + Structural Space).

Homeowners Association (HOA):

An organization in a subdivision, planned community, or condominium that makes and enforces rules for the properties in its jurisdiction. HOAs collect monthly or annual dues and act as the legal entity responsible for construction, ownership, ongoing maintenance, and liability for amenities in common areas, such as **parks**, tennis courts, elevators, and swimming pools. HOAs can levy special assessments on homeowners when the association lacks sufficient reserves to pay for unexpected repairs and can place liens on property owners behind on their dues. An HOA that chooses to register with the City ONC shall be included in official **notification** requirements of projects per **Table 3.4** on page 36 and **Table 3.5** on page 37 of this Plan.

Institutional Uses

Uses related to non-profit organizations dedicated to religious, educational, healthcare, or social functions.

Intent:

A clarifying statement that sets forth a broad desired outcome. A statement of intent does not require specific actions unless the mandatory word “shall” is specifically used.

Intelligent Transportation Systems (ITS):

Telecommunications technologies employed to minimize traffic congestion, air pollution and fuel consumption. ITS can include variable message signs, wireless communication, closed-circuit television (CCTV) cameras and advanced traffic signal controls.

3.0 ADMINISTRATION



Kiosks: Mobile structures that have functioning wheels and an axle, including mobile vending carts, mobile food units, and raw produce vending stands, for the sale of goods including but not limited to food, produce, flowers, and/or arts and crafts.

Live-Work: A dwelling unit that is also used for work purposes, such as professional office, artist’s workshop, or studio, located on the street level and constructed as separate condominium units or as a single unit. The ‘live’ component may be located on the street level (behind the work component) or any other level of the building. Live-work unit is distinguished from a home occupation otherwise defined by this Plan in that the work use is not required to be incidental to the dwelling unit, non-resident employees may be present on the premises, and customers may be served on site.

Living Fence: A landscaping treatment, which may include earth berms, a minimum of three feet tall with vegetation dense and tall enough at maturity to screen **abutting** uses, particularly parking areas. Appropriate species shall be selected from the Plant List in **Table 9.5** starting on page 153 in this Plan.

Lot: A separate tract or parcel of land platted and placed in the County Clerk’s record in accordance with applicable laws and ordinances.

Low Impact Design (LID): An approach to managing rainwater runoff that emphasizes conservation and use of on-site natural features to protect water quality. Using engineered small-scale hydrologic controls, LID works to replicate the pre-development condition by infiltrating, filtering, storing, evaporating, and detaining runoff close to its source. Frequently used LID techniques include bioretention cells (rain gardens), cisterns, pervious paving, bioswales, water harvesting in landscape areas, parking islands, street medians, and commercial filter systems.

Major Employer: A company with 150+ employees in a particular structure or campus.

Manufacturing, Light Manufacture from previously prepared materials or finished products or parts, including processing, fabrication, assembly, treatment, packaging, incidental storage, sales, and distribution.

Massing As referenced in Building Design Standards in **Section 5**, massing describes the arrangement of three-dimensional volumes that make up a building’s form. Architectural elements such as windows, doors and roofs as well as interior floor plans can also affect building mass. Massing is an important factor in the visual interest of a building and how it complements its surroundings.



Living Fence on the West Side

3.0 ADMINISTRATION

R

3

Merchants Association:

A voluntary member organization of businesses within a self-defined area. Merchants Associations typically collect regular dues to pool funds that pay for maintenance, improvements, property management, marketing, etc. for privately owned amenities. Merchants Associations that choose to register with the City Office of Neighborhood Coordination (ONC) shall be included in official **notification** of projects per **Table 3.4** on page 36 and **Table 3.5** on page 37 of this Plan.

Mixed Use:

Any legal combination of permitted or approved conditional land uses, typically referring to a mix of residential and non-residential uses. In this Plan, all Character Zones include a mix of uses. The particular mix of uses is tailored for each zone based on location, access, and surrounding context. One character zone is named Mixed Use to distinguish it from the **Center Zones** and the **Transition Zones**.

Neighborhood Association:

A voluntary member organization of residents within a self-defined area. Membership in a Neighborhood Association is defined by each individual Neighborhood Association's by-laws. A neighborhood association that chooses to register with the City ONC shall be included in official **notification** requirements of projects per **Table 3.4** on page 36 and **Table 3.5** on page 37 of this Plan.

Notice of Decision (NOD):

The official document issued by the Planning Director or his/her designee, the DRB, or the EPC that contains the decision regarding a given application.

Notification:

Notification is the requirement of an **applicant** to notify, by certified/return receipt mail, two duly authorized representatives of any **Neighborhood Association** or other association registered with the Office of Neighborhood Coordination within, abutting, or adjacent to the area covered by the Site Development Plan. See **Table 3.4** and **Table 3.5** for projects requiring the Planning Director or his/her designee to notify property owners within 100 feet of the project boundary, at the applicant's expense.

Open Space:

In lowercase letters, a generic term for any outdoor space or amenity intended to retain access to open air and sunlight, regardless of location, ownership, or management responsibility—e.g., landscaped medians, buffers, **paseos**, **setbacks**, **courtyards**, **community gardens**, or balconies. Open space is required through various means in order to provide a psychological and physical respite from development densities. Healthy places balance density vs. openness, urban vs. natural environments. For City-owned open space, see Open Space, Major Public.

Open Space, Civic:

Publicly accessible areas within the **Build-to Zone** along public rights-of-way, such as plazas, **paseos**, and patios, or other private open space areas to which the public has been granted access through a public access easement. These spaces may count as either **usable** or **detached open space**.



*Open Space,
Detached:*

Outdoor space required by zone to balance development densities in a developing area. **Detached open space** shall be provided via dedication, on-site, or cash-in-lieu per City Zoning Code §14-16-3-8. See requirements in **Section 9.4** starting on page 143. Management responsibilities for dedicated lands shall be determined as part of the developer’s dedication agreement. Detached open space requirements are in addition to, and calculated and administered separately, from **usable open space** or Impact Fees.

*Open Space,
Developed:*

Any portion of **usable open space** that has been improved from its natural state with a constructed **private open space amenity**, whether accessible privately or publicly (i.e. **plaza, amphitheater, playground, balcony**, etc.) .

*Open Space,
Major Public
(MPOS):*

Publicly-owned spaces managed by City Open Space Division. These are typically greater than five acres and may include natural resources, preserves, recreational facilities, dedicated lands, or trail corridors. The **Petroglyph National Monument** is Major Public Open Space, managed jointly by the National Park Service and City Open Space Division.

*Open Space,
Usable:*

Outdoor space to be preserved on-site and managed privately to help ensure livable conditions on each site. See **Section 9.5** starting on page 144. On-site open space in non-residential and mixed use developments shall be accessible to the public, with the exception of balconies, porches, **courtyards**, and landscape areas.

*Open Space
Network:*

The totality of **Major Public Open Space** managed by the City Open Space Division, comprising native or minimally-developed areas such as public rights-of-way, trail corridors, and environmentally **sensitive lands** that are preferably (but not necessarily) visually or physically linked.

*Open Space,
Private:*

Any open space owned, managed, and maintained privately. Private open space may count as **usable** or **detached open space**, depending on whether it is provided on the same site as the proposed project. For all residential and mixed uses, privately accessible open spaces such as **courtyards**, porches, and balconies may count as **usable open space**. Private open space amenities shall be the responsibility of property owners/ developers for the cost of construction, and ongoing maintenance and liability shall also be privately funded, such as by a **POA** or **HOA**. Property owners may grant public access to **private open space** via a public access easement that remains with the property in perpetuity. To be dedicated to the City for ongoing maintenance and liability responsibility, such spaces must meet City standards and be acceptable to and accepted by the relevant City department.

Parapet:

A low wall that serves as a vertical barrier at the edge of a roof, terrace, or other raised area; in an exterior wall, the part entirely above the roof.

Park:

A **civic space** programmed for active recreation, available for passive recreation, and accessible to the public.

3.0 ADMINISTRATION



Parking Court in Nob Hill



Paseo



Paseo in Downtown



Patio on the West Side

Parking, Angled: Refers to both “head-in” parking and “reverse-angle” parking, sometimes referred to as “back-in” angle parking. [See also “Reverse-angle Parking.”]

Parking Court: A small parking area surrounded by three wings of a **building**, served by one-way access from an **‘A’ Street**, with angled parking spaces screened by vegetation or **living fence**.

Paseo: Linear urban spaces that connect one street to another at through-block locations. These civic open spaces are dedicated to pedestrian movement between blocks and buildings or along **alleys**. Paseos may terminate public streets within the Plan area.

Patio: An outdoor space for dining or recreation that adjoins a residence or non-residential use and is often paved. It may also be a roofless inner **courtyard** within a residential or non-residential use.

Pedestrian-oriented: A term describing those aspects of a project intended primarily for the benefit of access, amenities, or services for people on foot or bicycle, including design details at the scale of the human body.

Permeable Paving: Hardscape material used as a means of allowing water and air to penetrate to underlying soil or gravel reservoir for storm water control, reduction in heat island effect, and the health of planted materials. Examples include pave stones, matrix materials, permeable asphalt, or permeable concrete.

Planning Director: The Director of the City of Albuquerque Planning Department or his/her designee.

Petroglyph National Monument:

Over 7,000 acres of **Major Public Open Space** designated a national monument by the U.S. Congress in 1990 and jointly managed in the public interest by the City Open Space Division and the National Park Service. The Plan area abuts the Monument to the east.

Playgrounds

Civic open spaces designed and equipped for children’s recreation. Playgrounds should serve as quiet, safe places – protected from the street and typically located where children do not have to cross major streets to access. Playgrounds may be fenced. An open shelter, play structures, interactive art and/or fountains may be included. A larger playground may be incorporated into a **park**, whereas a more intimate playground may be incorporated into a **recreation area**.

Plaza:

A primarily hardscaped, **civic open space** with formal landscaping, available for civic purposes and commercial activities. A plaza shall be defined spatially by **buildings** but may have street frontage on up to two sides.

Pilaster:

A pier or pillar attached to the wall or portion of the wall that projects slightly to resemble a column, often with capital and base.

Portal:

A portion of the ground-level, main façade of the **building** that is recessed, with a **colonnade** supporting the upper floors of the building. Portals are intended to provide weather protection for pedestrians to access buildings with ground-floor commercial or retail uses.

Porte Cocheres:

A roofed structure covering a driveway at the entrance of a building to provide shelter while entering or leaving a vehicle.

3.0 ADMINISTRATION

Primary Street: See **Streets, Primary.**

Private Open Space Amenity: Could include a pool (swimming, lap pool, spa area), play courts (basket ball, tennis), picnic areas with shade structures, etc.

Property Owners Association (POA): Typically a non-voluntary organization that collects regular dues from all property owners within a self-defined area to pay for ongoing maintenance, liability, and operations of privately owned amenities that benefit properties within the self-defined area. A POA that chooses to register with the City ONC shall be included in official **notification** requirements of projects per **Table 3.4** on page 36 and **Table 3.5** on page 37 of this Plan.

Public Improvement District (PID): A method of funding subdivision improvements, such as roads, public buildings, drainage infrastructure and recreational facilities through special assessments added to property taxes for properties within the defined boundaries of the district. See **Section 14.3.2**

Public Utility Structure: Per City Zoning Code §14.16.1.5.

Recreation Area: A **civic open space** intended for passive, unprogrammed, low-impact recreation not typically defined spatially by building façades. Recreational areas are typically naturalistic with minimal improvements.

Retail Sales: Retail establishments are the final step in the distribution of merchandise. They are organized to sell items in small quantities to many customers. Establishments in stores operate as fixed point-of-sale locations, which are designed to attract walk-in customers. Retail establishments often have displays of merchandise and sell to the general public for personal or household consumption, though they may also serve businesses and institutions. Some establishments may further provide after-sales services, such as repair and installation. Included in, but not limited to, this category are durable consumer goods sales and service, consumer goods, other grocery, food, specialty food, beverage, dairy, etc., and health and personal services.

Reverse-angle Parking: On-street, angled parking where cars back into a parking space, sometimes referred to as “back-in angled parking.” The procedure is generally easier than parallel parking and safer for multimodal streets – particularly for cyclists – because of greater visibility when cars pull into the travel lane. [See **Exhibit 13.2** for examples.]

Right-of-Way (ROW): The area of land dedicated to or acquired by the city, county, or state primarily for the use of the public for the movement of people, goods, and vehicles.

Rock Outcropping: Bedrock or other stratum a minimum of 6 feet high on its steepest side as measured from the adjacent 10% slope line and in excess of 500 SF in surface area.



Playground on the West Side



Portal on the West Side



Rock Outcropping in Volcano Heights

3.0 ADMINISTRATION

R

3



Roof Terrace in East Downtown



Building Blade Sign in Downtown

*Roof Terraces/
Gardens:*

Flat areas on top of a building that are accessible for use as a recreation or gardening space for the residents and users of the building.

Sensitive Lands:

Areas with environmental concerns that warrant special consideration for nearby development. Sensitive lands include, but are not limited to, the volcanic Escarpment; the Petroglyph National Monument; **Major Public Open Space**; or archaeologically, culturally, and/or geologically significant areas.

Service Uses:

A category for limited personal service establishments that offer a range of personal services including (but not limited to) clothing alterations, shoe repair, dry cleaners, laundry, health and beauty spas, tanning and nail salons, hair care, etc.

Setback:

The required minimum distance between the property line and the **building façade** or structure.

*Secondary
 Dwelling Unit:*

A minor second dwelling unit up to 650 SF associated with a single-family detached dwelling unit permitted anywhere on the lot except the front yard.

Secondary Street:

See **Streets, Secondary**.

*Senior Housing
 Facility:*

An age restricted residential complex that may be in a variety of housing forms— attached or detached dwelling units, apartments, private or semi-private rooms — occupied by senior citizens. The property shall be operated as “Housing for Older Persons” as defined in the Federal Housing for Older Persons Act (42U.S.S., para 3607(b)(2)) and uses will include related facilities and services, such as a common dining area, private recreational facilities, housekeeping assistance, medical services including but not limited to dietary and nutritional assistance, or incidental services related to daily living. Facilities meeting the definition of a Community Residential Program cannot be included under the Senior Facility Housing use.

*Sign, Building
 Blade:*

A **pedestrian-oriented** sign affixed perpendicular to the corner of a building or along the front façade of a building above the ground floor to provide identification for the whole building.

*Sign,
 Freestanding:*

Includes both permanent and temporary signs placed within a building’s front yard. Freestanding signs may be pole or **monument signs**.

3.0 ADMINISTRATION

Sign, Marquee: A sign structure placed over the entrance to a theatre or other public gathering venue. It has signage stating either the name of the establishment or, in the case of theatres or other public venues, the name of the event, artist, and other details of the event appearing at that venue. The marquee is often identifiable by a surrounding cache of light bulbs, usually yellow or white, that flash intermittently or in sequence as chasing lights. Marquee signs may be combined with **building blade signs**.

Sign, Monument: Any **freestanding sign** connected to the ground with no clear space for the full width of the sign between the bottom of the sign and the surface of the ground. A monument sign may include a sign face and sign structure and may also include a sign base and sign cap.

Sign, Sandwich Board: A portable sign consisting of two panels of equal size, which are hinged at the top or one panel with a support and placed on the ground or pavement so as to be self-supporting.

Sign, Tenant Blade: A **pedestrian-oriented** sign smaller than a **building blade sign**, affixed perpendicular to the building façade under a canopy or **awning** or immediately over a tenant space to provide identification for individual tenants within a building.

Sign Plan, Master: A plan submitted along with a Site Development Plan indicating the dimensions, location, colors, lighting, motion, and materials of all proposed signage. Elevation drawings of all signs shall be included on the signage plan.

Significant Infrastructure: Determined on a case-by-case basis but generally including a major street, drainage or utility facility, etc. necessary to develop the subject property as well as other nearby properties.

Significant Rock Outcropping: See “Rock Outcropping.”

[Amended November 5, 2014]



Blade and Marquee Signs in Downtown



Monument Sign on the West Side

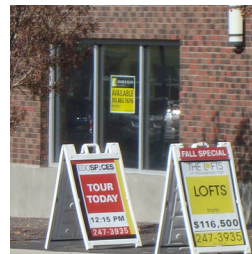

Sandwich Board Signs in East Downtown

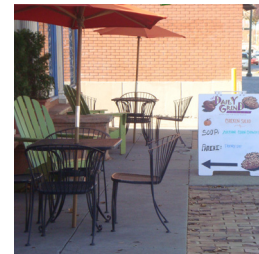

Tenant Blade Signs in East Downtown

3.0 ADMINISTRATION

R

3



Single-loaded Roads Next to Open Space in Albuquerque

Single-loaded Road:

A road with development only on one side. In this Plan, a single-loaded road is the recommended transition from the Petroglyph Monument Boundary to development in the Escarpment Transition Zone.

Site Development Plan:

A shortened phrase referring to a Site Development Plan for Building Permit. [Site Development Plan cannot be used interchangeably with “Site Development Plan for Subdivision.”] Where used as a plural in this Plan (i.e. “Site Development Plans”) without a qualifier (i.e. “for Building Permit” or “for Subdivision”), it refers to both Site Development Plans for Building Permit and Site Development Plans for Subdivision.

Site Development Plan for Building Permit:

As per City Zoning Code §14-16-1-5, an accurate Plan at a scale of at least 1 inch to 100 feet, which covers a specific site. Submittal requirements may vary based on the size of the development, proposed uses, and existing conditions surrounding the site.

Site Development Plan for Subdivision:

As per City Zoning Code §14-16-1-5, a Site Development Plan for Subdivision includes information used to plat a lot for future development.

Site Development Standards:

Standards established for each Character Zone that specify the height, bulk, orientation, and arrangement of elements for all new construction and redevelopment.

Slip Lane:

A traffic lane provided along a thoroughfare to allow vehicles to drive at a slower rate than the through lanes without interfering with through traffic. Slips lanes are separated from through lanes by a median and typically allow parking on one or both sides.

Soffit:

The exposed underside of any architectural element, especially a roof, or the underside of a structural component such as a beam, arch, or recessed area.

Special Assessment District (SAD):

A defined area in which property owners pay a fee in addition to property taxes to fund necessary infrastructure improvements to support development, such as drinking water and sewer lines, streets, and other government services, in new subdivisions. The assessed fee cannot be greater than the calculated benefit to the value of the property. [See **Section 14.3.1**]

Sprayground:

A fully automated water feature in which people of all ages can play. Spraygrounds may be private or public.

Stepback:

An offset between the lower and upper story or stories of a building in order to eliminate the “canyon effect” of multi-story buildings along a roadway.

Storage:

A space or place where goods, materials, or personal property is placed and kept for more than 24 consecutive hours.

Street Designations:

Refer to either **‘A’** or **‘B’ Streets** in this Plan. **Exhibit 4.1** on page 64 in **Section 4.5** shows character zones and street types and street designations applicable to **Primary Streets**, subject to the standards in this Plan.

Street, Neighborhood: A street that is primarily for access to **abutting** properties and carries relatively low traffic volumes.

Streets, Primary: A minimal network of streets critical to supporting future development within Volcano Heights. Primary Street alignments are mapped in **Exhibit 10.1**. Street locations have some flexibility per **Table 10.1** but shall retain the general grid pattern and a minimum level of connectivity to serve pedestrians and disperse auto traffic. Primary Streets include cross sections per **Section 10.6** starting on page 173.

Streets, Secondary: Local streets added to the backbone grid of Primary Streets primarily to provide access to individual developments but also to enhance connectivity for all modes of transportation and to help support retail and employment uses. This Plan provides a menu of options for Secondary Street standards and typical cross sections in **Section 10.7** starting on page 199.

Streetlights, Cobrahead: A typical streetlight installation with a light fixture resembling a cobra head mounted on a distribution pole high enough to light a roadway. Cobrahead lights are typically used to serve **auto-oriented** streets, as the tall distribution poles are out of scale with the pedestrian realm.

Streetlights, Column: A typical streetlight installation for retail areas. The light fixture is mounted on a distribution pole at a height at the pedestrian scale to serve the pedestrian as well as the auto realm.

Streetscape: All elements within the public right-of-way between private property lines, including but not limited to travel lanes, median, curb and gutter, bike lanes, bike buffer, street trees, sidewalk, and landscaping. The term generally connotes the intent to create attractive, multi-modal streets that work well for all users.

Street Screen: A freestanding wall or **living fence** built along the frontage line or in line with the **building façade** along the street. It may mask a parking lot or a loading/service area from view or provide privacy to a side yard and/or strengthen the spatial definition of the public realm.

Structure: Per City Zoning Code §14-16-1-5. Includes buildings, carports, porches, and wireless communications facilities, for example. [A **building** is a structure, but a structure is not necessarily a building.]

Structure Height: The vertical distance above the approved grade of the highest point of any structure on the site, except where defined by roof pitch. See **Building Height**.

Tax Increment Development District (TIDD): The geographic area where a Tax Increment (i.e. a piece or portion of future gains of taxes used to finance current improvements) is generated and in which the proceeds of the tax increment must be expended. [See **Section 14.3.3** starting on page 248.]



Sprayground Features in Albuquerque

3.0 ADMINISTRATION

R

3

Transition Zones: Areas intended to buffer existing and planned lower-density and single-family residential development and **sensitive lands** from higher-density, higher-intensity uses toward the center of the Plan area. In this Plan, Neighborhood Transition zones are located on the northern and southern boundaries of the Plan area, and Escarpment Transition zone is located along the eastern edge of the Plan area. Transition Zones include limits on building heights and scale, as well as business operations for conditional uses.

Transom: A bar, typically wood or stone, across the top of a door or window, or a small hinged window above a door or another window.

Undevelopable Land: Land that is not suitable for cut or fill and includes, but is not limited to, significant **rock outcroppings** as defined by this Plan.

Water Harvesting: A water conservation method used to capture, divert, and/or store rainwater for plant irrigation and other uses. A simple system usually consists of an area to catch water (i.e. catchment area or cistern) and a means to distribute water using gravity. Water is directed to landscape holding areas, concave or plated areas with “edges” to retain water, which can be used immediately by nearby plants.

Zoning Map: A regulatory map that shows the character zones applicable to the Volcano Heights Plan area subject to the standards in this Plan.



4.0 ZONING

CHAPTER II: REGULATIONS

4.0 ZONING

R

4

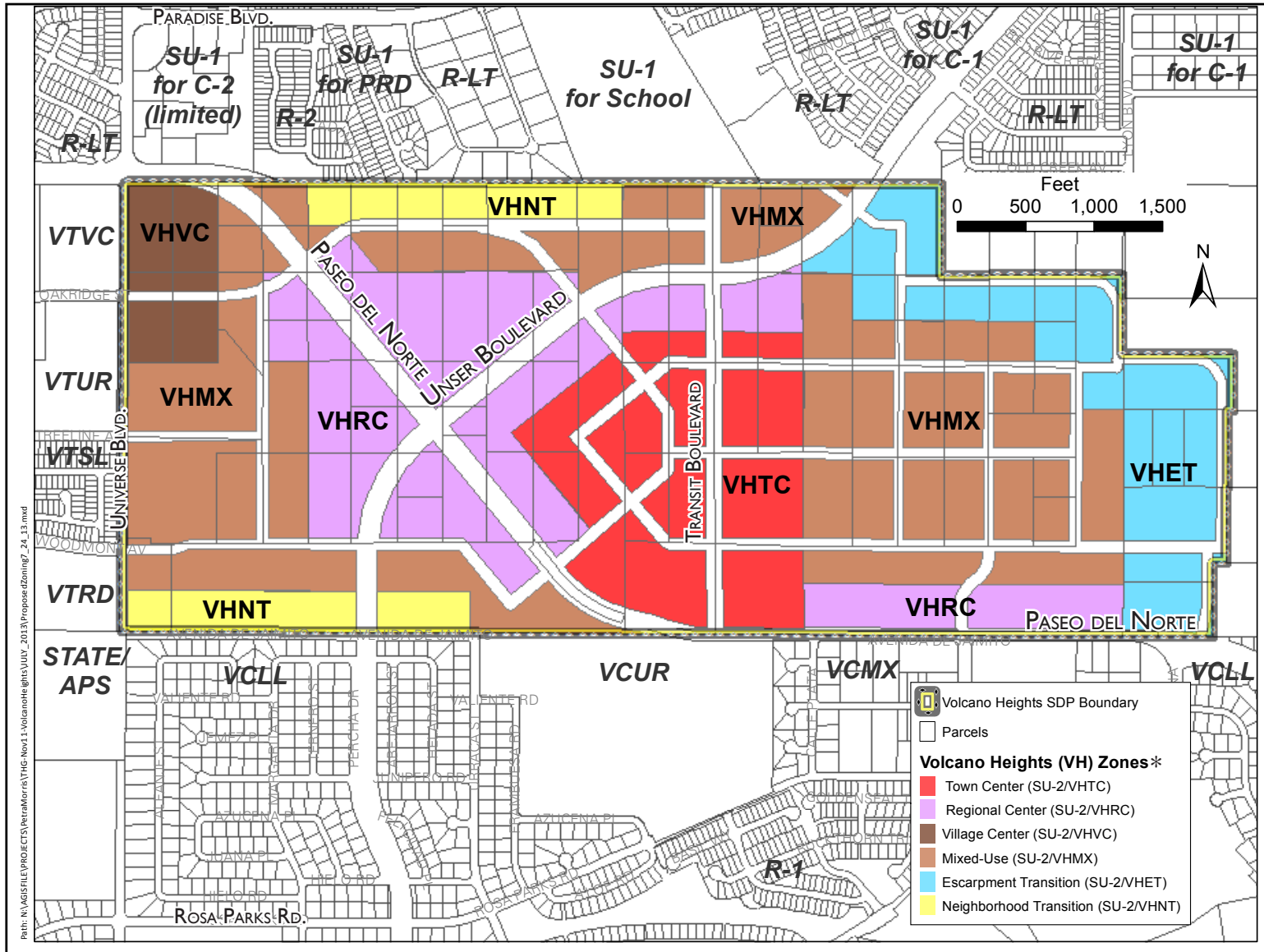

EXHIBIT 4.1 – ZONING ESTABLISHED BY THE VOLCANO HEIGHTS SECTOR DEVELOPMENT PLAN



4.1. Adoption of Volcano Heights Zoning

4.1.1. The Volcano Heights Zoning Map (**Exhibit 4.1**) is hereby adopted as the official **zoning map**. Within any area subject to the approved zoning map, this Plan establishes mandatory regulations and governs all subject properties.

4.1.2. **Zone Lines and Property Lines:** In **Exhibit 4.2**, properties designated with more than one zone are identified by labels A-V. Where zone lines do not correspond to property lines, they shall begin at or be measured according to the methods corresponding to **Exhibit 4.2** and **Table 4.1**.

- (i) **Property Index:** The properties with multiple zones are also shown in **Table 4.2**, organized alphabetically by property as an index for easy reference.
- (ii) **Property Ownership:** See **Exhibit A.39** in **Appendix A**.
- (iii) **Legal Descriptions:** Available for each property on the City of Albuquerque Geographic Information Systems (GIS) page: <http://www.cabq.gov/gis>

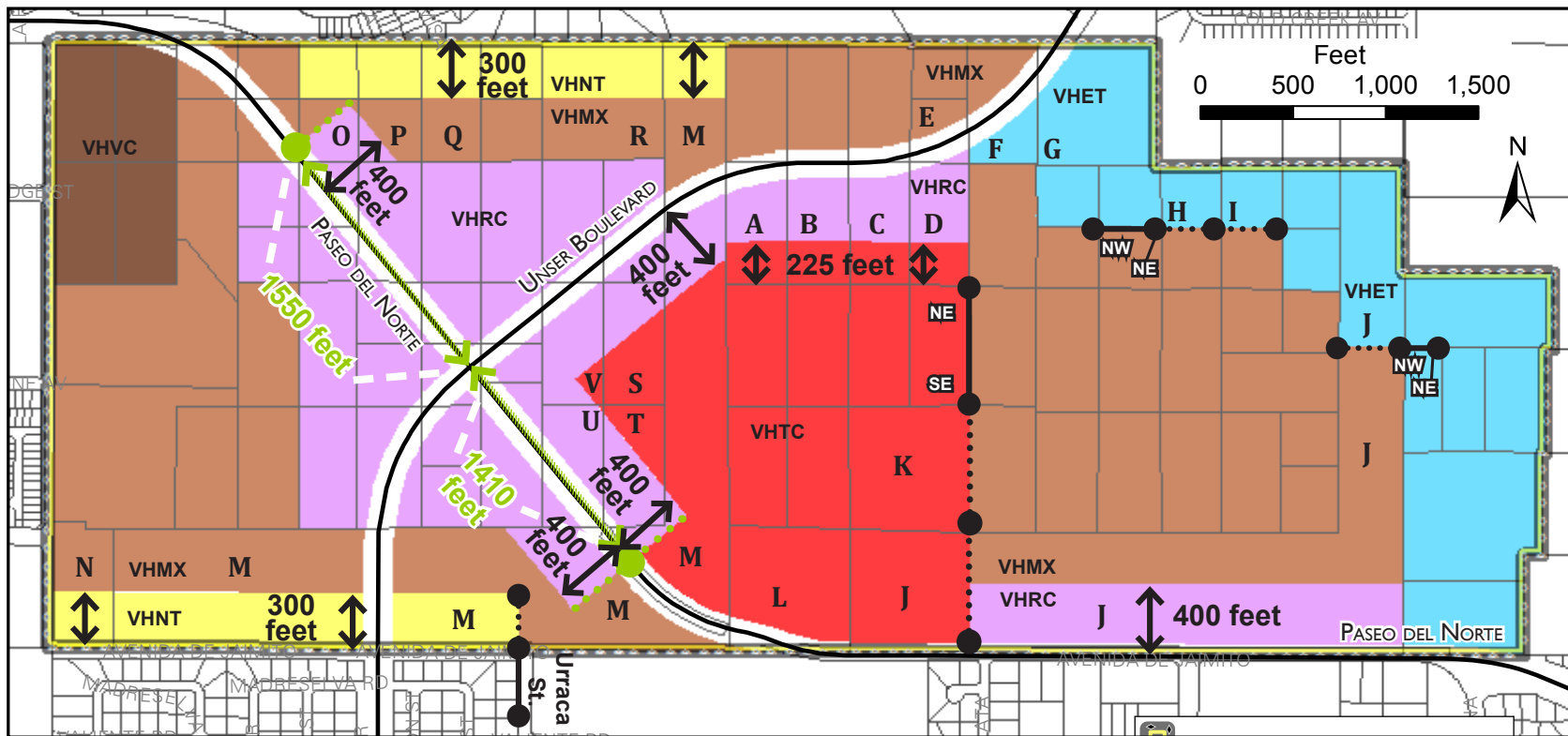

EXHIBIT 4.2 – ZONING DEMARCATION FOR PROPERTIES WITH MULTIPLE ZONES

CHAPTER II: REGULATIONS

4.0 ZONING

R

4

TABLE 4.1 – ZONE DEMARCATION FOR PROPERTIES WITH MULTIPLE ZONES

ITEM	VOLCANO HEIGHTS SU-2 ZONE	ZONE DEMARCATION DESCRIPTION	RELEVANT PROPERTIES
TC 1	Town Center	For properties labeled A, B, C, or D, the Town Center zone shall extend 225 feet from the southern property edge due north. The remaining portion of the property shall be zoned RC. [See also RC 1 .]	A B C D
TC 2		For properties labeled J and K, the eastern edge of Town Center shall follow the same bearing as the line formed between the northeast and southeast corners (i.e. the eastern property edge) of the property to the north as shown in Exhibit 4.2 to the southern edge of the subject property.	J K
TC 3		For the property labeled L, the portion of the property north of Paseo del Norte shall be zoned Town Center; the remainder of the property shall be zoned MX. [See also MX 5 .]	L
TC 4		For the portion of the property labeled M that is northeast of Paseo del Norte, the RC zone shall be designated per RC 3 in this table, with the remainder zoned Town Center. [For the portion of the property southwest of Paseo del Norte, see also RC 5 , MX 6 , NT 1 , and NT 2 .]	M
TC 5		For properties labeled S through V, the Regional Center zone shall be designated per RC 3 in this table; the remainder of the properties shall be zoned Town Center.	S T U V
RC 1	Regional Center	For the properties labeled A through D, the Town Center zone shall be designated per TC 1 in this table. The remaining portion of the property to the northern property line shall be zoned Regional Center.	A B C D
RC 2		For the property labeled E, the portion of the property southeast of Unser Boulevard shall be designated the Regional Center zone.	E

TABLE 4.1 – ZONE DEMARCATION FOR PROPERTIES WITH MULTIPLE ZONES (Cont'd.)

ITEM	VOLCANO HEIGHTS SU-2 ZONE	ZONE DEMARCATION DESCRIPTION	RELEVANT PROPERTIES
RC 3	Regional Center <i>(continued)</i>	Where this zone applies to a portion of the property only, the zone shall extend 400 feet from the centerline of Unser Boulevard or Paseo del Norte as of 2013, whichever is closer to the property, except for the four properties labeled A through D.	J M O P S T U V
RC 4		For the property labeled J, the western edge of Regional Center shall be defined per the line described in TC 2 in this table. [See also RC 3 , RC 4 , MX 3 , and ET 3 .]	J
RC 5		For the properties labeled M and O, the edge of the Regional Center zone not defined by a property line shall be defined by a line perpendicular to the centerline of Paseo del Norte as of 2013 beginning at the intersection approved by TCC Resolution R-13-03. [See Appendix C .]	M O
MX 1	Mixed Use	For properties labeled E, F, and G the portion northwest of Unser Boulevard shall be zoned Mixed Use.	E F G
MX 2		For properties labeled H and I, Escarpment Transition zone shall be designated per ET 2 . The remaining portion of the property shall be zoned Mixed Use.	H I
MX 3		For the property labeled J, the portions of the property not zoned as noted below shall be zoned Mixed Use: <ul style="list-style-type: none"> • The portion of the property zoned Town Center shall be designated per TC 2 in this table. • The portion of the property zoned Regional Center shall be designated per RC 3 and RC 4 in this table. • The portion of the property zoned Escarpment Transition shall be designated per ET 3 in this table. 	J
MX 4		For the property labeled K, the Town Center portion of the property shall be zoned per TC 2 in this table; the remainder of the property shall be zoned MX.	K
MX 5		For the property labeled L, the Town Center portion of the property shall be zoned per TC 3 in this table; the remainder of the property southwest of Paseo del Norte shall be zoned MX.	L



CHAPTER II: REGULATIONS

4.0 ZONING

TABLE 4.1 – ZONE DEMARCATION FOR PROPERTIES WITH MULTIPLE ZONES (Cont'd.)

ITEM	VOLCANO HEIGHTS SU-2 ZONE	ZONE DEMARCATION DESCRIPTION	RELEVANT PROPERTIES
MX 6	Mixed Use (continued)	For the property labeled M: <ul style="list-style-type: none"> the portion of the property zoned TC shall be designated per TC 4 in this table; and the portion of the property zoned RC shall be designated per RC 3 and RC 5 in this table; and the portion of the property zoned NT shall be designated per NT 1 and NT 2 in this table; and the remainder of the property shall be zoned MX. 	M
MX 7		Where a property is zoned a combination of Mixed Use and Neighborhood Transition and/or Regional Center: <ul style="list-style-type: none"> the portion of the property zoned RC shall be designated per RC 3 in this table; and/or the portion of the property zoned NT shall be designated per NT 1 in this table; and the remainder of the property shall be zoned MX. 	N O P Q R
ET 1	Escarpment Transition	For the properties labeled E, F, and G, the portion of the subject property southeast of Unser Boulevard shall be zoned Escarpment Transition. [See also MX 1 in this table.]	E F G
ET 2		For the properties labeled H and I, the Escarpment Transition zone shall extend from the northernmost property edge south to a line following the same bearing as the line formed between the northwest and northeast corners (i.e. the northern property edge) of the property to the west as shown in Exhibit 4.2 extending to the eastern edge of the subject property.	H I
ET 3		For the property labeled J, the Escarpment Transition zone shall extend from the northernmost property edge south to a line following the same bearing as the line formed between the northwest and northeast corners (i.e. the northern property edge) of the property to the east as shown in Exhibit 4.2 extending to the western edge of the subject property. [See also TC 2 , RC 3 , RC 4 , and MX 3 in this table.]	J
NT 1	Neighborhood Transition	Where this zone applies to a portion of the property only, the zone shall extend 300 feet from the border of the Plan area, which corresponds to property edges.	M N P Q R
NT 2		For the property labeled M, the eastern edge of the Neighborhood Transition zone shall follow the same bearing as the line formed by the eastern edge of the platted roadway Urraca St. to the south. [See also NT 1 and MX 6 .]	M

R

4

TABLE 4.2 – ALPHABETICAL INDEX OF PROPERTIES WITH MULTIPLE ZONES

SUBJECT PROPERTY LABEL(S)	VOLCANO HEIGHTS SU-2 ZONES	RELEVANT ITEMS PER TABLE 4.1
A	Town Center	TC 1
B	Regional Center	RC 1
C		
D		
E	Regional Center Mixed Use	RC 2 MX 1
F	Mixed Use	MX 1
G	Escarpment Transition	ET 1
H	Mixed Use	MX 2
I	Escarpment Transition	ET 2
J	Town Center Regional Center Mixed Use Escarpment Transition	TC 2 RC 3 and RC 4 MX 3 ET 3
K	Town Center Mixed Use	TC 2 MX 4
L	Town Center Mixed Use	TC 3 MX 5
M	Town Center Regional Center Mixed Use Neighborhood Transition	TC 4 RC 3 and RC 5 MX 6 NT 1 and NT 2
N	Mixed Use Neighborhood Center	MX 7 NT 1
O	Regional Center	RC 3 and RC 5
P	Mixed Use	MX 7
Q	Mixed Use	MX 7
R	Neighborhood Transition	NT 1
S	Town Center	TC 5
T	Regional Center	RC 3
U		
V		

4.2. Establishment of Character Zones

The zoning map designates the following **character zones**.

4.2.1. **Town Center:** The Volcano Heights Town Center (SU-2/VHTC) zone is intended to implement the City’s vision for an urban center. Development in this zone is intended to create a major employment center with office, entertainment, urban residential, and supporting retail uses. Development can be a mix of employment centers, destination retail, and entertainment, restaurant, and urban residential uses. In addition to general standards in **Sections 6-9**, development within the Town Center Zone shall meet the Site Development and Building Design Standards in **Section 5.1** of this Plan.



Town Center Character Zone

4.2.2. **Regional Center:** The Volcano Heights Regional Center (SU-2/VHRC) zone is intended to provide an appropriate transition into Volcano Heights from the regional, limited-access Paseo del Norte and Unser Boulevard. This area is also intended for large-format and destination retail and office development. In addition to general standards in **Sections 6-9**, development within the Regional Center Zone shall meet the Site Development and Building Design Standards in **Section 5.2** of this Plan.



Regional Center Character Zone

4.2.3. **Village Center:** The Volcano Heights Village Center (SU-2/VHVC) zone is intended for smaller-scale, neighborhood-oriented retail and office development with gateway elements at key intersections. In addition to general standards in **Sections 6-9**, development within the Village Center Zone shall meet the Site Development and Building Design Standards in **Section 5.3** of this Plan.



Village Center Character Zone

4.0 ZONING

R



Mixed-Use Character Zone

4.2.4. **Mixed-Use:** The Volcano Heights Mixed Use (SU-2 VHMx) zone is intended to provide the most flexibility of use and development standards surrounding the Regional and Town Centers. VHMx also serves to buffer **Transition zones** from the **auto-oriented** uses of the Regional Center and the more intensive urban uses and taller buildings allowed within the Town Center. In addition to general standards in **Sections 6-9**, development within the Mixed Use Zone shall meet the Site Development and Building Design Standards in **Section 5.4** of this Plan.

4



Escarpment Transition Character Zone

4.2.5. **Escarpment Transition:** The Volcano Heights Escarpment Transition (SU-2 VHET) zone is intended to protect **sensitive lands** in the eastern portion of the Plan area **adjacent** to the Petroglyph National Monument from the higher-density and intensity **mixed uses** in adjacent zones. Properties **adjacent** to or **abutting** the Monument are subject to the Rank 3 NWMEP regulations for “Impact Area” designation where it covers this area.

This zone is intended for single-family residential, live-work, and townhouse uses as well as smaller-scale office, and neighborhood retail in key locations. In addition to general standards in **Sections 6-9**, development within the Escarpment Transition zone shall meet the Site Development and Building Design Standards in **Section 5.5** of this Plan.



Neighborhood Transition Character Zone

4.2.6. **Neighborhood Transition:** The Volcano Heights Neighborhood Transition (SU-2 VHNT) zone is intended to provide transitions of building scale and uses from the more dense, urban Mixed Use zone to adjoining neighborhoods north and south of the Plan area.

This zone is intended for single-family residential, **live-work**, and townhouse uses as well as some smaller-scale office uses in appropriate areas. In addition to general standards in **Sections 6-9**, development within the Neighborhood Transition zone shall meet the Site Development and Building Design Standards in **Section 5.6** of this Plan.

TABLE 4.3 – CHARACTER ZONES BY LAND USE CATEGORY

CHARACTER ZONE		LAND USE CATEGORY
CENTER ZONES		
	Town Center	Mixed Use / Non-residential
	Regional Center	Mixed Use / Non-residential
	Village Center	Mixed Use / Non-residential
	Mixed Use	Mixed Use / Non-residential
TRANSITION ZONES		
	Escarpment Transition	Mixed Use / Residential
	Neighborhood Transition	Residential



- 4.3. Table of Land Uses:** Due to the emphasis on urban form over land uses, general land use categories have been identified by **character zone** in **Table 4.4**. Zones allow a mix of appropriate uses from the following categories, listed on a separate page(s) in this order:
- Residential Uses
 - Commercial Uses (Office, Retail, Sales, and Service Uses)
 - Arts, Entertainment, and Recreation Uses
 - Educational, Public Administration, Health Care, and Other Institutional Uses
 - Manufacturing, Transportation, Communication, and Utility Uses
 - Other Uses

Where a use is allowed on a conditional basis, **Table 4.5** provides performance criteria relevant to protect the quality of the built environment and intent of the vision of this Plan, in addition to the criteria for conditional uses in City Zoning Code §14-16-4-2.

4.3.1. Uses not listed but substantially similar and that meet the intent of the Zone in which it is proposed may be permitted upon approval of the Planning Director or his/her designee.

- 4.3.2. All uses shall be conducted in a fully-enclosed building, except as provided below, and shall have no noise, vibration, particulate, or odor that poses an adverse impact on adjacent properties.
- (i) Where allowed by zone per **Table 4.4**, the following may be conducted partially or completely outdoors:
 - a. Auto-related sales, including vehicle fuel sales;
 - b. Any permitted use with a drive through facility;
 - c. Plant nurseries, retail garden centers, and community gardens;
 - d. Recreational uses;
 - e. Wind and solar energy equipment;
 - f. Transit facilities;
 - g. Public utility facilities;
 - h. Sales from kiosks;
 - i. Commercial surface parking lots;
 - j. Structured parking
 - (ii) See **Section 6.9.3** starting on page 124 for regulations affecting outdoor storage.
 - (iii) See **Section 6.9.4** starting on page 124 for design regulations affecting loading/unloading areas on ‘B’ Streets.
 - (iv) See **Section 6.8.3** starting on page 123 for street screen requirements.

CHAPTER II: REGULATIONS

4.0 ZONING

R

4

TABLE 4.4 – LAND USE TABLE BY CHARACTER ZONE

	CHARACTER ZONE	TOWN CENTER	REGIONAL CENTER	VILLAGE CENTER	MIXED-USE	ESCARPMENT TRANSITION	NEIGHBORHOOD TRANSITION
	LAND USE						
	RESIDENTIAL USES						
RU-1	Home Occupations	P	P	P	P	P	P
RU-2	Multi-family residential						
RU-2 G	Ground floor	C	P	C	P	P	C
RU-2 U	Upper floors	P	P	P	P	P	C
RU-3	Residential Lofts	P	P	P	P	P	P
RU-4	Single-family residential attached dwelling unit (Townhomes)	P	NP	P	P	P	P
RU-5	Single-family residential detached	NP	NP	NP	NP	P	P
RU-6	Secondary dwelling unit	P	NP	P	P	P	P
RU-7	Live-work unit	P	NP	P	P	P	P
RU-8	Senior housing facility	C	C	P	P	C	C

P= Permitted by right NP= Not Permitted

C = Permitted with specific criteria as established in **Table 4.5** (i.e. conditional)

A = **Accessory Use**, not to exceed 25% of the primary use building square footage

NA= Not applicable



TABLE 4.4 – LAND USE TABLE BY CHARACTER ZONE (Cont'd)

	CHARACTER ZONE	TOWN CENTER	REGIONAL CENTER	VILLAGE CENTER	MIXED-USE	ESCAPMENT TRANSITION	NEIGHBORHOOD TRANSITION
	LAND USE						
	COMMERCIAL USES (OFFICE, RETAIL, SALES, AND SERVICE USES)						
CU-1	Retail Sales or Service with no drive through facility (includes alcohol sales). <i>Excluded from this category are retail sales and service establishments geared toward the automobile.</i>	P	P	P	P	C	NP
CU-2	Auto-related Sales or Service establishments	C	P	C	C	NP	NP
CU-3	Finance and Real Estate establishments including banks, credit unions, real estate, and property management services, with no drive through facility	P	P	P	P	C	NP
CU-4	Offices for business, professional, administrative, and technical services such as, but not limited to, accountants, architects, lawyers, doctors, insurance sales/services , etc.	P	P	P	P	C	C
CU-5	Research laboratory headquarters, laboratories and associated facilities	P	P	P	P	NP	NP
CU-6	Food Service Uses such as full-service restaurants, cafeterias, bakeries and snack bars with no drive-through facilities*	P	P	P	P	C	NP
CU-7	Pet and animal sales or service (including vet clinic)	P	P	P	P	C	NP
CU-8	Any permitted use with a drive through facility	C	P	C	C	NP	NP

P= Permitted by right NP= Not Permitted C = Permitted with specific criteria as established in **Table 4.5** (i.e. conditional) A = **Accessory Use**, not to exceed 25% of the primary use building square footage NA= Not applicable

* Note for CU-6: Included in this category is café seating within a public or private sidewalk area with no obstruction of pedestrian circulation. Also included in this category is the sale of alcoholic beverages for consumption on and off-premise.

4.0 ZONING



4

TABLE 4.4 – LAND USE TABLE BY CHARACTER ZONE (Cont'd)

	CHARACTER ZONE	TOWN CENTER	REGIONAL CENTER	VILLAGE CENTER	MIXED-USE	ESCAPMENT TRANSITION	NEIGHBORHOOD TRANSITION
	LAND USE						
	ARTS, ENTERTAINMENT, AND RECREATION USES						
AU-1	Art galleries	P	P	P	P	C	NP
AU-2	Art, antique, furniture or electronics studio (retail, repair or fabrication; excludes auto electronics sales or service)	P	P	P	P	C	NP
AU-3	Games establishments (includes arcades)	P	P	P	P	NP	NP
AU-4	Theater, cinema, dance, or music establishment	P	P	P	P	NP	NP
AU-5	Museums and other special purpose recreational institutions	P	P	P	P	NP	NP
AU-6	Adult amusement establishments or adult store*	NP	P	NP	NP	NP	NP
AU-7	Fitness, recreational sports, gym, or athletic club	P	P	P	P	C	NP
AU-8	Parks, greens, plazas, squares, and playgrounds	P	P	P	P	P	P

P= Permitted by right NP= Not Permitted C = Permitted with specific criteria as established in **Table 4.5** (i.e. conditional) A = **Accessory Use**, not to exceed 25% of the primary use building square footage NA= Not applicable

* Note for AU-6: A separation of at least 1,000 feet shall be maintained between adult amusement establishments or adult stores. No adult amusement establishments or adult stores shall be allowed within 500 feet of a residential zone, including but not limited to Volcano Heights Transition Zones.

TABLE 4.4 – LAND USE TABLE BY CHARACTER ZONE (Cont'd)

	CHARACTER ZONE	TOWN CENTER	REGIONAL CENTER	VILLAGE CENTER	MIXED-USE	ESCARPMENT TRANSITION	NEIGHBORHOOD TRANSITION
	LAND USE						
	EDUCATIONAL, PUBLIC ADMINISTRATION, HEALTH CARE, AND OTHER INSTITUTIONAL USES						
EU-1	Business associations, professional membership organizations, social & fraternal organizations	P	P	P	P	NP	NP
EU-2	Child day care and preschools	P	P	P	P	P	P
EU-3	Schools, libraries, and community halls	P	P	P	P	P	NP
EU-4	Universities and colleges	P	P	P	P	NP	NP
EU-5	Technical, trade, and specialty schools	P	P	P	P	NP	NP
EU-6	Hospitals and nursing establishments	P	P	P	P	NP	NP
EU-7	Social services and philanthropic organizations	P	P	P	P	C	C
EU-8	Rehabilitative clinics	P	P	P	P	NP	NP
EU-9	Public administration uses (including local, state, and federal government uses, public safety, health and human services)	P	P	P	P	C	C
EU-10	Religious institutions	P	P	P	P	C	NP
EU-11	Funeral homes	P	P	P	P	NP	NP

P= Permitted by right NP= Not Permitted

C = Permitted with specific criteria as established in Table 4.5 (i.e. conditional)

A = **Accessory Use**, not to exceed 25% of the primary use building square footage

NA= Not applicable

CHAPTER II: REGULATIONS

4.0 ZONING

R

TABLE 4.4 – LAND USE TABLE BY CHARACTER ZONE (Cont'd)

	CHARACTER ZONE	TOWN CENTER	REGIONAL CENTER	VILLAGE CENTER	MIXED-USE	ESCARPMENT TRANSITION	NEIGHBORHOOD TRANSITION
	LAND USE						
	MANUFACTURING, TRANSPORTATION, COMMUNICATION, AND UTILITY USES						
MU-1	Food, beverage, and textile product manufacturing	C	P	NP	P	NP	NP
MU-2	Wood, paper, and printing products manufacturing	NP	P	NP	NP	NP	NP
MU-3	Machinery, electronics, and transportation equipment manufacturing	NP	P	NP	P	NP	NP
MU-4	Miscellaneous light manufacturing (included in this category are jewelry, silverware, personal metal goods, flatware, dolls, toys, games, musical instruments, office supplies, and signs.)	NP	P	NP	C	NP	NP
MU-5	Wholesale trade establishment	NP	P	NP	P	NP	NP
MU-6	Warehouse and storage services	NP	P	NP	P	NP	NP
MU-7-A	Transit Facilities*	P	P	P	P	P	C
MU-7-B	Transportation services (air, rail, road, truck and freight)	NP	P	NP	NP	NP	NP
MU-8	Publishing (newspaper, books, periodicals, software)	P	P	P	P	NP	NP
MU-9	Motion picture and sound recording	P	P	P	P	C	NP
MU-10	Telecommunications and broadcasting (radio, TV, cable, wireless communications, telephone, etc)	P	P	P	P	NP	NP
MU-11	Information services and data processing	P	P	P	P	NP	NP

P= Permitted by right NP= Not Permitted

C = Permitted with specific criteria as established in **Table 4.5** (i.e. conditional)

A = **Accessory Use**, not to exceed 25% of the primary use building square footage

NA= Not applicable

* Note for MU-7-A: Bus maintenance facilities shall only be permitted in Regional Center.

TABLE 4.4 – LAND USE TABLE BY CHARACTER ZONE (Cont'd)

	CHARACTER ZONE	TOWN CENTER	REGIONAL CENTER	VILLAGE CENTER	MIXED-USE	ESCARPMENT TRANSITION	NEIGHBORHOOD TRANSITION
	LAND USE						
MU-12	Electric switching stations, electric generation stations, natural gas regulating stations, public water system treatment plants and storage facilities, wastewater treatment plants, and/or other major utility services	NP	P	NP	P	NP	NP
MU-13	Electric substations, telephone switching stations, and/or other minor utility services	P	P	P	P	P	P

P= Permitted by right NP= Not Permitted

C = Permitted with specific criteria as established in **Table 4.5** (i.e. conditional)

A = **Accessory Use**, not to exceed 25% of the primary use building square footage

NA= Not applicable



CHAPTER II: REGULATIONS

4.0 ZONING

R

TABLE 4.4 – LAND USE TABLE BY CHARACTER ZONE (CONT'D)

	CHARACTER ZONE	TOWN CENTER	REGIONAL CENTER	VILLAGE CENTER	MIXED-USE	ESCAPMENT TRANSITION	NEIGHBORHOOD TRANSITION
	LAND USE						
	OTHER USES						
OU-1	Model homes for sales and promotion*	P	P	P	P	P	P
OU-2	Hotels	P	P	P	P	P	NP
OU-3	Bed and Breakfast	NP	NP	NP	P	P	P
OU-4	Commercial surface parking lot (primary use of property)	C	C	C	C	NP	NP
OU-5	Parking, structured	P	P	P	P	NP	NP
OU-6	Private attached garage**	C	NP	C	P	P	P
OU-7	Private detached garage**	NP	NP	NP	P	P	P
OU-8	Sales from kiosks (includes food carts)	C	C	C	C	C	NP
OU-9	Veterinary clinic	P	P	P	P	NP	NP
OU-10	Community garden	C	C	C	P	P	P
OU-11	Concealed Antennas including cell, accessory, and mounted on top of buildings. (Excluded from this category are freestanding and commercial antennas and equipment buildings.) [See Section 7.9 starting on page 131.]	P/A	P/A	P/A	P/A	NP	P/A
OU-12	Wind energy equipment***	P/A	P/A	P/A	P/A	C/A	C/A
OU-13	Solar energy equipment***	P/A	P/A	P/A	P/A	P/A	P/A

P= Permitted by right NP= Not Permitted C = Permitted with specific criteria as established in Table 4.5 (i.e. conditional) A = **Accessory Use**, not to exceed 25% of the primary use building square footage NA= Not applicable

* Note for OU-1: Model homes are limited to a time period until all the homes are sold in the neighborhood.

** Note for OU-6: Subject to Garage design standards in Section 7.7 starting on page 129.

*** Note for OU-12 and OU-13: As defined and regulated by the Rank 2 Facility Plan: Electric System Generation and Transmission (2010-2020).



4.4. Criteria for Conditional Uses: All uses listed as Conditional (C) in **Table 4.4** shall also meet the following standards in **Table 4.5**, in addition to the City Zoning Code §14-16-4-2.

TABLE 4.5 – CONDITIONAL USE CRITERIA (Cont'd)

USE	ZONE	LOCATION & DESIGN CRITERIA
RESIDENTIAL USES		
RU-2-G	Multi-family residential (Ground Floor)	Town Center, Village Center, and Neighborhood Transition
RU-2-U	Multi-family residential (Upper floors)	Neighborhood Transition
RU-8	Senior housing facility	Town Center, Regional Center, and Transition Zones



CHAPTER II: REGULATIONS

4.0 ZONING

R

4

TABLE 4.5 – CONDITIONAL USE CRITERIA (Cont'd)

	USE	ZONE	LOCATION & DESIGN CRITERIA
NON-RESIDENTIAL USES			
CU-1	Retail sales or service with no drive-through facility (includes alcohol sales)	Escarpment Transition	<ul style="list-style-type: none"> • Character complements nearby single-family development. • Scale and massing complementary to nearby single-family development. • Location restricted to any corner of the intersection of two streets. • Surface parking lot restricted to no more than 10 spaces. • Any buildings associated with the use shall also have a pedestrian entrance at an 'A' Street.
CU-2	Auto-related sales and service	Town Center and Village Center	<ul style="list-style-type: none"> • Gas pumps, canopies, and/or service bays shall not be located along any 'A' Street frontage. • No more than 50% of a lot's frontage along a Primary Street shall be occupied by gas pumps, canopies, and/or service bays. • Any buildings associated with the use shall also have a pedestrian entrance at an 'A' Street. • No outdoor storage of vehicles or other products sold shall be permitted along 'A' Streets or Primary Streets. All auto-related sales displays shall be inside storefronts or along 'B' Streets.
		Mixed Use	<ul style="list-style-type: none"> • Gas pumps, canopies, and/or service bays shall not be located along any 'A' Street frontage. • No more than 50% of a lot's frontage along a Primary Street shall be occupied by gas pumps, canopies, and/or service bays. • Any buildings associated with the use shall also have a pedestrian entrance at an 'A' Street. • Outdoor storage of vehicles or other products sold shall not be permitted along 'A' Streets. Along Paseo del Norte or Unser Boulevard, outdoor storage of vehicles or other products sold shall not exceed 50% of a lot's frontage. There shall be no such limitation along Secondary 'B' Streets or alleys.
CU-3	Finance and real estate establishments	Escarpment Transition	<ul style="list-style-type: none"> • Character complements nearby single-family development. • Scale and massing complementary to nearby single-family development. • Any buildings associated with the use shall also have a pedestrian entrance at an 'A' Street.
CU-4	Offices	Transition Zones	<ul style="list-style-type: none"> • Character complements nearby single-family development. • Scale and massing complementary to nearby single-family development. • Any buildings associated with the use shall also have a pedestrian entrance at an 'A' Street.
CU-6	Food service uses	Escarpment Transition	<ul style="list-style-type: none"> • Character complements nearby single-family development. • Scale and massing complementary to nearby single-family development. • Location restricted to any corner of the intersection of two streets. • Off-street parking lots required but restricted to no more than 30 spaces. • Any buildings associated with the use shall also have a pedestrian entrance at an 'A' Street.

TABLE 4.5 – CONDITIONAL USE CRITERIA (Cont'd)

USE	ZONE	LOCATION & DESIGN CRITERIA
CU-7 Pet and animal sales or service	Escarpment Transition	<ul style="list-style-type: none"> • Character complements nearby single-family development. • Scale and massing complementary to nearby single-family development. • Any buildings associated with the use shall also have a pedestrian entrance at an 'A' Street. • Any overnight pet boarding shall be indoors.
CU-8 Any permitted use with a drive-through facility	Town Center, Village Center, Mixed Use	<ul style="list-style-type: none"> • All drive-through access (driveways) shall be from a 'B' Street only. If the lot has no access to any 'B' Street, then access may be from an 'A' Street with approval by the Planning Director or his/her designee. • Drive through lanes and/or canopies shall not have frontage or be located along any 'A' Street. • Drive through areas shall be screened by a 4-foot high street screen along 'B' Streets. • Drive through facilities shall meet the standards in Section 6.8 and 6.9 starting on page 124.
AU-1 Art galleries	Escarpment Transition	<ul style="list-style-type: none"> • Character complements nearby single-family development. • Scale and massing complementary to nearby single-family development. • Any buildings associated with the use shall also have a pedestrian entrance at an 'A' Street. • Off-street parking lots restricted to no more than 10 spaces.
AU-2 Art, antique, furniture or electronics studio	Escarpment Transition	<ul style="list-style-type: none"> • Character complements nearby single-family development. • Scale and massing complementary to nearby single-family development.
AU-7 Fitness, recreational sports, gym, or athletic club	Escarpment Transition	<ul style="list-style-type: none"> • Off-street parking lot required but limited to no more than 4.5 spaces per 1,000 square feet. • Character complements nearby single-family development. • Scale and massing complementary to nearby single-family development. • Any buildings associated with the use shall also have a pedestrian entrance at an 'A' Street.
EU-7 Social services and philanthropic organizations	Transition Zones	<ul style="list-style-type: none"> • Character complements nearby single-family development. • Scale and massing complementary to nearby single-family development. • Any buildings associated with the use shall also have a pedestrian entrance at an 'A' Street.
EU-9 Public administration uses	Escarpment Transition	<ul style="list-style-type: none"> • Character complements nearby single-family development. • Scale and massing complementary to nearby single-family development.
EU-10 Religious Institutions	Escarpment Transition	<ul style="list-style-type: none"> • Off-street parking required but limited to no more than 1 space per 3 sanctuary seats. • Character complements nearby single-family development. • Scale and massing complementary to nearby single-family development. • Any buildings associated with the use shall also have a pedestrian entrance at an 'A' Street.



4.0 ZONING

R

4

TABLE 4.5 – CONDITIONAL USE CRITERIA (Cont'd)

	USE	ZONE	LOCATION & DESIGN CRITERIA
MU-1	Food and textile product manufacturing	Town Center	<ul style="list-style-type: none"> • Scale and massing complementary to walkable, urban built environment. • Off-street parking required but may be provided off-site. • Any buildings associated with the use shall also have a service entrance on a 'B' Street for deliveries and maintenance equipment.
MU-4	Miscellaneous manufacturing	Mixed-Use	<ul style="list-style-type: none"> • Scale and massing complementary to walkable, urban built environment. • Off-street parking required but may be provided off-site. • Any buildings associated with the use shall also have a service entrance on an 'B' Street for deliveries and maintenance equipment. • Activities shall be buffered appropriately to mitigate noise and emission impact on neighboring properties.
MU-9	Motion picture and sound recording	Escarpment Transition	<ul style="list-style-type: none"> • Character complements nearby single-family development. • Scale and massing complementary to nearby single-family development. • Activities shall be buffered appropriately to mitigate noise impact on neighboring properties.
OTHER USES			
OU-4	Commercial surface parking lot (primary use of property)	Town Center, Regional Center, Village Center, and Mixed Use	<ul style="list-style-type: none"> • Shall be permitted as an interim use of property (permits provided in 5-year increments). • Applications for new surface lots shall include phasing of infill building concepts on the lot. • New surface parking shall be set back a minimum of 30 feet from the edge of the ROW of 'A' Streets, with street screen and buffer landscaping provided within setback area. • New surface parking shall not be located at a street intersection for a minimum distance of 30 feet along each street from the intersection.
OU-6	Attached garage	Town Center, Village Center	<ul style="list-style-type: none"> • Shall be alley-accessed only.

TABLE 4.5 – CONDITIONAL USE CRITERIA (Cont'd)

Use	ZONE	LOCATION & DESIGN CRITERIA
OU-8 Sales from kiosks on private property	Center Zones, Mixed Use, and Escarpment Transition	<ul style="list-style-type: none"> • Sales of goods from mobile kiosks are permitted as a temporary land use, typically limited to 6 months or less but subject to determination by the ZHE on a case-by-case basis. • Kiosks shall be placed in appropriate locations, such as off-street parking areas or paved areas with the permission of the property owner. • If one location has more than five (5) kiosks, the site layout and location shall be indicated on a site plan on file with the City of Albuquerque Environmental Health Department, Fire Department, and the Planning Department, and shall include authorization from the property owner. [A special event permit may be required.] • If located in an existing parking lot, kiosks shall not encumber more than 25% of the required off-street parking. The impacted parking spaces shall be considered “available” and therefore still meeting off-street parking requirements. No off-street parking is required to serve kiosks. • All food sales are subject to permitting and regulation by the City of Albuquerque Environmental Health Department. • Outdoor seating areas are permitted in the public ROW provided that they maintain a minimum 6-foot clear pedestrian path per DPM Chapter 23, Section 7, Part B.5. • Other conditions shall be per the discretion of the ZHE and decided on a case-by-case basis.
OU-10 Community garden	Center Zones	<ul style="list-style-type: none"> • Shall be no larger than 1.0 acre. • Gardens shall be enclosed by a fence on all open sides. • Fences shall be installed straight and plumb, with vertical supports at a minimum of 8 feet on center. • Chicken wire is permitted if used with another permitted fencing material. Where used, chicken wire shall be continuously supported along all edges. <p><i>Fencing Materials:</i></p> <ul style="list-style-type: none"> • Permitted: wood, chicken wire, wrought iron, painted galvanized steel • Not permitted: materials including but not limited to chain link, barbed or razor wire and/or tape, vinyl, and/or plywood
OU-12 Wind energy equipment	Escarpment Transition	<ul style="list-style-type: none"> • Freestanding wind turbines shall be placed on the rear of the property and shall not front an ‘A’ Street. • Building-mounted wind turbines shall be permitted pending design review by the Planning Director or his/her designee. They shall not be mounted on the ground floor.

This Page Left Intentionally Blank



5.0 SITE DEVELOPMENT AND BUILDING DESIGN STANDARDS SPECIFIC TO ZONES



5.1. Town Center Zone

5.1.1. Illustrations and Intent

Note: These are provided as illustrations of intent. The illustrations and statements on this page are advisory only and do not have the power of law. Refer to the standards on the following pages for the specific Site Development and Building Design Standards.



The Town Center Zone Site Development Standards are intended to address development along a proposed **Bus Rapid Transit (BRT)** corridor near the center of the Volcano Heights Plan area. Development standards in this **character zone** are intended to take advantage of its location along a transit corridor and promote a dense, urban, pedestrian-friendly development pattern accessible via all transportation modes.



With the smallest **block sizes** of all the zones and the tallest potential **structure heights**, this **character zone** generally accommodates development of neighborhood-serving and destination retail, employment centers, urban residential, and entertainment uses. The goal is to encourage transit-oriented development within a quarter-mile radius of the proposed Transit Boulevard and eventual Transit Center.



In addition, Town Center development sites shall be planned in such a manner as to accentuate intersections, with taller buildings that are closer to the street. The required site development pattern of building pads, parking, driveways, and service areas is intended to provide opportunities for short-term development while allowing for planned urban block infill development in the long-term.



5.0 SITE DEVELOPMENT STANDARDS SU-2 VHTC

5.1.2 Building Placement

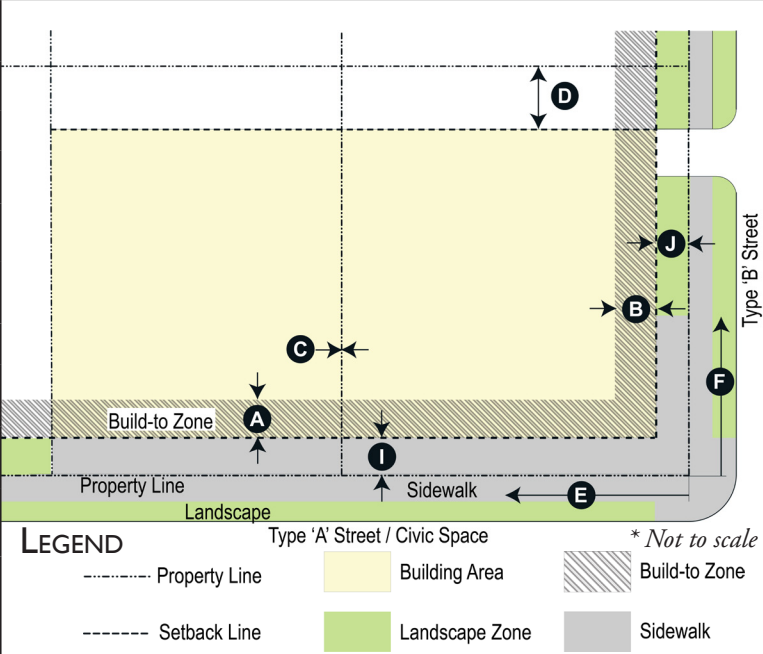

5.1.4 Height Standards

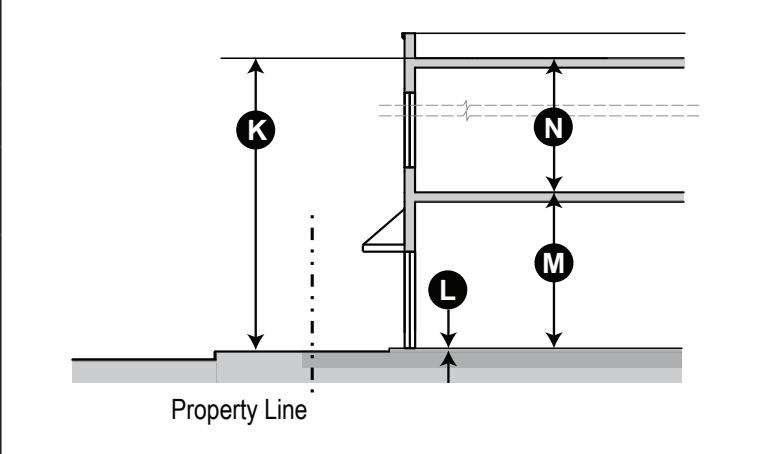

(i) Build-To Zone (BTZ) [measured from setback]

Front (if 'A' Street and/or Civic Space)	0 – 10 feet (see #1)	A
Front (if 'B' Street)	0 – 15 feet	B

(ii) Setback [measured from property line]

Front (if 'A' Street and/or Civic Space)	5 feet (max. .)	I
Front (if 'B' Street)	10 feet (max.)	J
Side or Rear (distance from property line)	0 feet (min.) (See #2)	C, D

(iii) Building Frontage Required

% of building built to 'A' Street/Civic Space BTZ	80% (min.) (see #3 and #6)	E
% of building built to 'B' Street BTZ	30% (min.) (See #3 and #6)	F

5.1.3 Block Standards [for development/redevelopment > 50% of the block]

Block Face Dimensions	225 feet (min.) 500 feet (max.)
Block Perimeter	2000 feet (max.)

Height Standards

Maximum structure height	3 stories or 40 feet (max.) (See #7 and Sections 6.3 and 6.4)	K
First floor-to-floor height	12 feet (min.) (See #4 and Section 5.1.5)	M
Ground Floor finish level	12 inches max. above sidewalk (for ground floor commercial-ready buildings)	L
Upper floor-to-floor height	10 feet (min.) (See #4)	N

5.1.5 Commercial-ready Requirements

Ground floors of all buildings fronting the **Transit Boulevard** shall be built to **commercial-ready** standards for a minimum of the first 30 feet of the building's depth, as measured from the front façade, including 15-foot minimum first floor-to-floor height, ingress and egress, handicap access, and first floor elevation flush with the sidewalk.

Notes

- #1 – Area between the building and the edge of the **BTZ** at the sidewalk shall be paved flush with the public sidewalk. Where topography poses challenges, a majority of the sidewalk shall be provided at the level of the building, with appropriate approved transitions to the changed topography level.
- #2 – Side and rear setbacks shall be based on minimum fire separation required between buildings, if applicable.
- #3 – Corner building street façades shall be built to the **BTZ** for a minimum of 30 feet from the corner along both streets or the width of the corner lot, whichever is less. Recessed entrances are permitted as long as the upper floors meet the **BTZ** standards.
- #4 – Floor to floor heights shall not apply to parking structures.
- #5 – **Attics and mezzanines** less than 7 feet (avg.) in height shall not be counted as a story.
- #6 – Civic open space within the **BTZ** shall count toward the frontage requirement.
- #7 – Corner buildings may exceed the maximum building height by 15% for 20% of the building's frontage along each corresponding street façade.

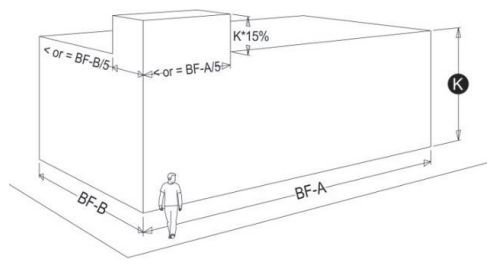

5.0 SITE DEVELOPMENT STANDARDS

<p>5.1.6 Parking and Service Access</p>	<p><i>(i) Parking Location</i></p>	<p>5.1.7 Other Standards</p>																														
<p>Legend</p> <ul style="list-style-type: none"> Property Line Surface Parking Area Building Footprint Above Grade Parking Area <p>* NOT TO SCALE</p>	<table border="1"> <tr> <td colspan="2">Surface/At-grade Parking [See also Section 6.8.4 starting on page 123]</td> <td></td> </tr> <tr> <td>'A' Street/ Civic Space setback</td> <td>Shall be located behind the principal building</td> <td>O</td> </tr> <tr> <td>'B' Street setback</td> <td>Min. of 3 feet behind building façade line along that street</td> <td>Q</td> </tr> <tr> <td>Side and Rear setback (<i>distance from property line</i>)</td> <td>0 feet min. (see Note # 2)</td> <td>P R</td> </tr> <tr> <td colspan="2">Above-grade Parking</td> <td></td> </tr> <tr> <td>Setback along 'A' & 'B' Streets or Civic Space</td> <td>May be built up to the building façade line along that street</td> <td>O*</td> </tr> <tr> <td>Side and Rear setbacks (<i>distance from property line</i>)</td> <td>0 feet (min.) (see Note # 2)</td> <td>P</td> </tr> <tr> <td colspan="2">(ii) Required Off-Street Parking Spaces</td> <td></td> </tr> <tr> <td>Non-residential uses within 250 feet of single-family residential</td> <td>1 space per every 300 gross square feet</td> <td></td> </tr> <tr> <td>Residential Uses</td> <td>None</td> <td></td> </tr> </table>	Surface/At-grade Parking [See also Section 6.8.4 starting on page 123]			'A' Street/ Civic Space setback	Shall be located behind the principal building	O	'B' Street setback	Min. of 3 feet behind building façade line along that street	Q	Side and Rear setback (<i>distance from property line</i>)	0 feet min. (see Note # 2)	P R	Above-grade Parking			Setback along 'A' & 'B' Streets or Civic Space	May be built up to the building façade line along that street	O*	Side and Rear setbacks (<i>distance from property line</i>)	0 feet (min.) (see Note # 2)	P	(ii) Required Off-Street Parking Spaces			Non-residential uses within 250 feet of single-family residential	1 space per every 300 gross square feet		Residential Uses	None		<p><i>(i) Encroachments</i></p> <ol style="list-style-type: none"> Canopies, signs, shade structures and balconies may encroach over the sidewalk as long as the vertical clearance is a minimum of 8 feet. In no case shall an encroachment be located over an on-street parking or travel lane. [See also Section 11.2.8 starting on page 207.] Building projections on all other façades may not be closer than 5 feet to any abutting property line. <p><i>(ii) Arcades and Colonnades</i></p> <ol style="list-style-type: none"> Arcades and colonnades are permitted within the build-to zone and shall be a minimum of 6 feet in depth. The minimum interior clearance height within an arcade or colonnade shall be 12 feet. <p><i>(iii) Walls and Fences:</i> Chain link fences and plastic vinyl fences shall not be permitted in the Town Center zone. [See also Section 9.7.4 starting on page 156 for other design standards.]</p> <p><i>(iv) General Site Development Standards:</i> See Section 6.0 starting on page 109.</p>
Surface/At-grade Parking [See also Section 6.8.4 starting on page 123]																																
'A' Street/ Civic Space setback	Shall be located behind the principal building	O																														
'B' Street setback	Min. of 3 feet behind building façade line along that street	Q																														
Side and Rear setback (<i>distance from property line</i>)	0 feet min. (see Note # 2)	P R																														
Above-grade Parking																																
Setback along 'A' & 'B' Streets or Civic Space	May be built up to the building façade line along that street	O*																														
Side and Rear setbacks (<i>distance from property line</i>)	0 feet (min.) (see Note # 2)	P																														
(ii) Required Off-Street Parking Spaces																																
Non-residential uses within 250 feet of single-family residential	1 space per every 300 gross square feet																															
Residential Uses	None																															
<p>5.1.8 Façade Elements</p>	<p><i>(iii) Driveways and Service Access</i></p>																															
<p><i>(i) Doors and Windows:</i></p> <ol style="list-style-type: none"> There shall be no blank walls greater than 25 feet in width of any building along 'A' Streets and Civic Spaces. There shall be no blank walls greater than 50 feet in width of any building along Primary 'B' Streets. For Secondary 'B' Streets there is no requirement. Doors and windows on the ground floor of all buildings shall constitute between 50% and 90% of the ground floor façade area along all 'A' Streets and Civic Spaces. Along 'B' Streets there is no requirement. Windows on upper floor façades along all 'A' Streets and Civic Spaces shall constitute a minimum of 25% of each upper floor façade area, which is measured between 3 feet and 9 feet above each finished floor. Primary entrance doors for all buildings shall be on 'A' Streets or Civic Spaces. <p><i>(ii) Façade Articulation:</i> Along Paseo del Norte, façades shall incorporate a corner element, articulated by a horizontal break of 3 feet max.</p>	<table border="1"> <tr> <td>Parking driveway width</td> <td>City DPM standards on arterial roadways and 25 feet max. on all other streets</td> <td>S</td> </tr> <tr> <td colspan="3"> <ul style="list-style-type: none"> Driveways and off-street loading and unloading shall not be located on 'A' Streets or Civic Spaces. [See also Section 6.8.3 starting on page 123.] Porte cocheres may be permitted on 'A' Streets to provide drop-off and valet service. Shared driveways and cross access easements are encouraged between lots to minimize curb cuts. If driveway and/or off-street service loading and unloading access is provided from an 'A' Street, such access is to be deemed as temporary, and cross access easements along the rear of the property may be required when adjoining properties are undeveloped. </td> </tr> </table>	Parking driveway width	City DPM standards on arterial roadways and 25 feet max. on all other streets	S	<ul style="list-style-type: none"> Driveways and off-street loading and unloading shall not be located on 'A' Streets or Civic Spaces. [See also Section 6.8.3 starting on page 123.] Porte cocheres may be permitted on 'A' Streets to provide drop-off and valet service. Shared driveways and cross access easements are encouraged between lots to minimize curb cuts. If driveway and/or off-street service loading and unloading access is provided from an 'A' Street, such access is to be deemed as temporary, and cross access easements along the rear of the property may be required when adjoining properties are undeveloped. 																											
Parking driveway width	City DPM standards on arterial roadways and 25 feet max. on all other streets	S																														
<ul style="list-style-type: none"> Driveways and off-street loading and unloading shall not be located on 'A' Streets or Civic Spaces. [See also Section 6.8.3 starting on page 123.] Porte cocheres may be permitted on 'A' Streets to provide drop-off and valet service. Shared driveways and cross access easements are encouraged between lots to minimize curb cuts. If driveway and/or off-street service loading and unloading access is provided from an 'A' Street, such access is to be deemed as temporary, and cross access easements along the rear of the property may be required when adjoining properties are undeveloped. 																																

5.0 BUILDING DESIGN STANDARDS SU-2 VHTC

R

Building Design Standards Specific to Town Center Character Zone: The following standards shall be used for new development or redevelopment within the Town Center Zone.

5.1.9. **Intent/Purpose:** Building Design Standards provide performance-based requirements intended to result in high-quality development and pedestrian-friendly environment in order to provide predictability over time and along corridors for property owners, neighbors, investors, and the public.

5.1.10. **Guidelines**

- (i) Buildings should generally have a rectangular layout scheme with single or multiple components with mostly flat front and square, round, or octagonal corner towers.
- (ii) Building **façades** may be symmetrical or asymmetrical, but the central part of the building should be expressed with well-balanced façade compositions.
- (iii) The ground floor should be taller and include heavier massing (i.e. clad in masonry or with a high proportion of fenestration to opaque wall area) than floors above. A **portal**, arcade, or **colonnade** may be incorporated and need not be massive if built at the ground floor. [See **Example A** for an illustration.]
- (iv) Buildings should be capped with wide and continuous eaves supported by open rafters and decorative brackets or finished with elaborate **parapet** walls covered by tile and very shallow eaves. [See **Example B** for an illustration.]

- (v) Storefronts should be inset with recessed entry or under an arcade or fit into arch openings, covered with shade **structures**. [See **Example C** for an illustration.]
- (vi) Shade structures, **blade signs**, arcades, **galleries**, café seating, and balconies should be used along commercial storefronts fronting an **'A' Street** or **Civic Space** to add pedestrian interest.
- (vii) **Courtyards** and **plazas** should be incorporated where possible, particularly along **'A' Streets**.

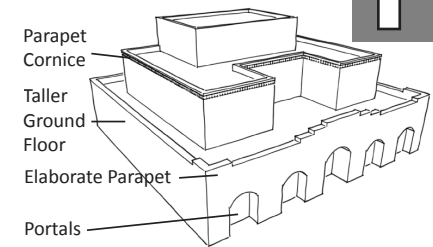

EXAMPLE A – PORTAL AND PARAPET

5

5.1.11. **Massing and Façade Composition**

- (i) **Articulation** along the base **façade** shall maintain a prevalent rhythm of 20-30 feet along all **'A' Streets**. This **façade** rhythm may be expressed by changing materials or color, using design elements such as columns and **pilasters**, or varying the setback of portions of the building façade.
- (ii) Doors or windows shall form regular patterns of openings, accentuated by balconies or equivalent architectural features.
- (iii) An expression line or equivalent architectural element shall delineate the base and cap of all buildings. A **parapet cornice** or equivalent architectural element shall delineate the caps of **façades** that do not use a pitched roof.
- (iv) Commercial and mixed-use building **façades** shall maintain the alignment of horizontal elements along the block.

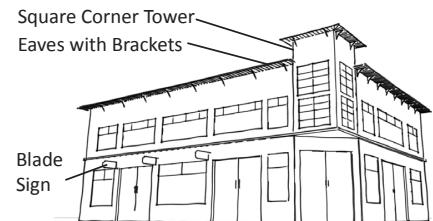

EXAMPLE B – EAVES AND TOWER ELEMENT

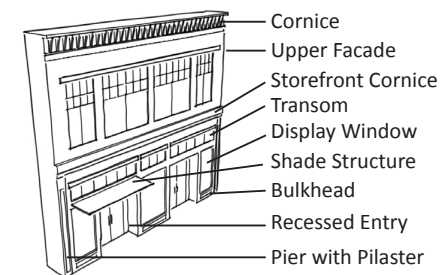

EXAMPLE C – STOREFRONT

5.0 BUILDING DESIGN STANDARDS

R

5

- (v) If a single-family building (e.g. townhouse) is set back less than 10 feet from the front property line, the grade of the slab or first floor elevation shall be elevated at least 18 inches above the grade of the sidewalk. If a single-family building is set back 10 feet or more from the property line and is not elevated at least 18 inches above the grade of the sidewalk, a 3-foot high fence or wall shall be provided at the front property line.

5.1.12. Building Materials

- (i) At least 75% of a building's base **façade** along all **'A' Streets** and **Civic Spaces** shall be composed of masonry, brick, or stucco using a process other than a one-step process.
- (ii) No more than 25% of a building's base **façade** along **'A' Streets** or **Civic Spaces** shall use other accent materials such as wood, architectural metal panel, split-face concrete block, tile, or pre-cast concrete panels. **Exterior Insulating Finishing System (EIFS)** shall not be permitted along any **'A' Street** or **Civic Space** façade.
- (iii) In addition to those permitted for the base **façade**, upper floors may include glass curtain wall, split-face concrete, or cementitious fiber board.
- (iv) All **façades** along **'B' Streets** or **alleys** shall be of a similar finished quality and color that blend with the front of the building. Building materials for these façades may be any of the primary and accent façade materials listed above.

- a. **EIFS** shall be limited to no more than 50% of the upper floor **façades** along **'B' Streets** and **alleys**.
- b. Cementitious-fiber clapboard shall be prohibited on mixed-use or residential frontages. On the upper floors of any commercial frontage, no more than 20% of a **'B' Street** or **alley façade** may be cementitious-fiber clapboard (not sheet), which shall have at least a 50-year warranty.
- (i) Other primary building materials shall be considered on a case-by-case basis by the Planning Director or his/her designee.
- (ii) Roofing materials for pitched roofs visible from any public **ROW** shall be predominantly barrel clay tile, copper, factory finished standing seam metal, slate, synthetic slate, or similar materials.

5.1.13. Windows

- (i) Glazing along **'A' Streets** shall not be opaque.
- (ii) To reduce mirror effect, windows shall be either glazing rated low-reflective value or a combination of glass and coating or finish to satisfy the equivalent standard. Highly reflective coatings and/or finishes are prohibited.
- (iii) Ornamental arches of various designs, where used, shall be deeper on the ground floor and shallower on upper floors.

5.0 BUILDING DESIGN STANDARDS SU-2 VHTC

5.1.14. **Architectural Details and Other Elements**

At least two (2) of the following detail elements shall be incorporated to provide visual interest:

- (i) detailing around principal openings including but not limited to decorative trim, carving, transoms, columns, pilasters, pediments, and/or architraves,
- (ii) window details such as but not limited to window sills, decorative leading, color, opaque treatments, multipane windows, soldier course, transoms, and/or lintels,
- (iii) metal railings at balconies,
- (iv) shade structures,
- (v) roof towers,
- (vi) forecourts,
- (vii) fountains or water features using recycled or reclaimed water,
- (viii) plazas,
- (ix) pedestrian furniture and/or life-size game boards,
- (x) masonry screen products for see-through walls or portions of walls,
- (xi) free-standing arbors, canopies, or towers,
- (xii) tower elements, and/or
- (xiii) other equivalent element, as approved by the Planning Director or his/her designee.

R

5

5.0 Site Development and Building Design Standards

R

5



5.2. Regional Center Zone

5.2.1. Illustrations and Intent

Note: These are provided as illustrations of intent. The illustrations and statements on this page are advisory only and do not have the power of law. Refer to the standards on the following pages for the specific Site Development Standards.

The Regional Center Zone site development standards are intended to address development along Paseo del Norte and Unser Boulevard in the central portion of the Volcano Heights Plan area. Development standards in this **character zone** are intended to acknowledge the primary regional traffic function of these roads while also capitalizing on the commercial and retail opportunities for **auto-oriented** development provided by the significant visibility and high-traffic flow of these regional arteries.



Generally, this **character zone** allows for a wide range of retail, office, service, and light industrial uses more dependent on the automobile. The goal is to encourage employment and destination retail that serves a broader, regional area as well as new residents and existing neighbors.



In addition, Regional Center Zone sites shall be planned in such a manner as to encourage buildings to be closer to the street at intersections in order to provide attractive, quality development along corridors in the short-term, as well as leaving room for urban block infill as the area becomes more dense and/or redevelops over time.

5.0 SITE DEVELOPMENT STANDARDS SU-2 VHRC

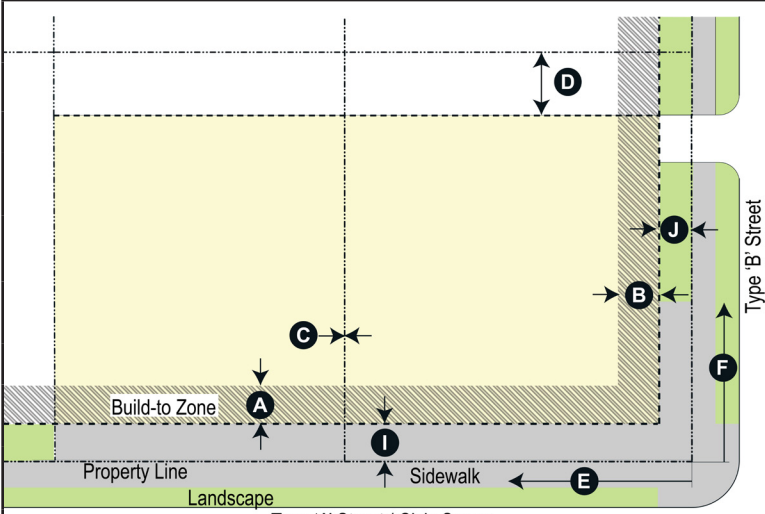
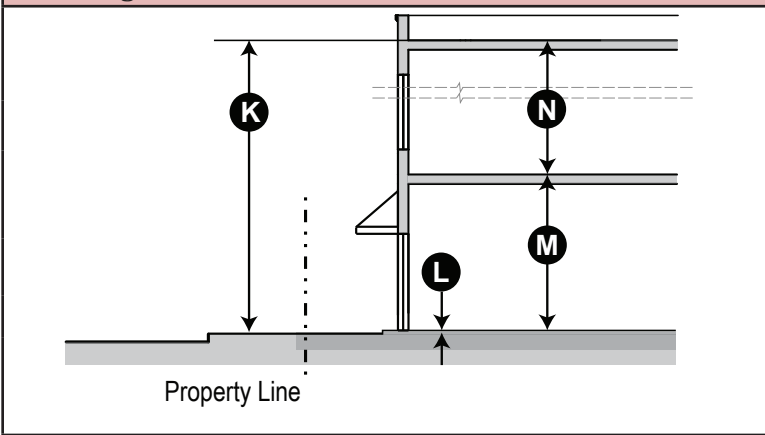
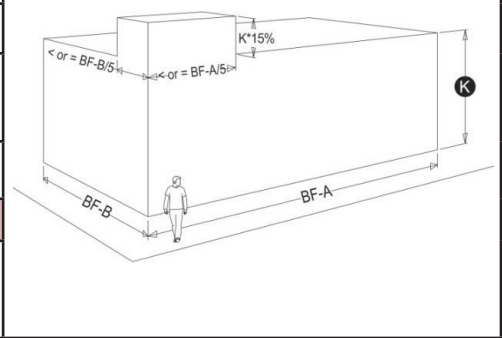
5.2.2 Building Placement	(i) Build-To Zone (BTZ) [measured from setback]	Notes	
 <p>Legend</p> <ul style="list-style-type: none"> Property Line (dashed line) Setback Line (dotted line) Building Area (yellow) Landscape Zone (green) Build-to Zone (hatched) Sidewalk (grey) <p>* Not to scale</p>	Front (if 'A' Street and/or Civic Space) 0 – 15 feet (see #1) A	#1 – Area between the building and the edge of the BTZ at the sidewalk shall be paved flush with the public sidewalk. Where topography poses challenges, a majority of the sidewalk shall be provided at the level of the building, with appropriate approved transitions to the changed topography level.	
	Front (if 'B' Street) 0 – 15 feet B		
	(ii) Setback [measured from property line]		
	Front (if 'A' Street and/or Civic Space) 5 feet (max.) I	#2 – Side and rear setbacks shall be based on minimum fire separation required between buildings, if applicable.	
	Front (if 'B' Street) 10 feet (max.) J		
	Side or Rear (distance from property line) 0 feet min. (see #2) C D	#3 – Corner building street façades shall be built to the BTZ for a minimum of 25 feet from the corner along both streets or the width of the corner lot, whichever is less. Recessed entrances are permitted as long as the upper floors meet the BTZ standards.	
	(iii) Building Frontage Required		
	% of building built to 'A' Street/Civic Space BTZ 60% (min.) (see #3 and #6) E	#4 – Floor to floor heights shall not apply to parking structures.	
	% of building built to 'B' Street BTZ 20% (min.) (see #3 and #6) F		
	5.2.3 Block Standards [for development/redevelopment > 50% of the block]	5.2.3 Block Standards [for development/redevelopment > 50% of the block]	#5 – Attics and mezzanines less than 7 feet (avg.) in height shall not be counted as a story. #6 – Civic open space within the BTZ shall count toward the frontage requirement.
5.2.4 Height Standards	Height Standards	#7 – Corner buildings may exceed the maximum building height by 15% for 20% of the building's frontage along each corresponding street façade.	
	Maximum structure height 3 stories or 40 feet (max.) (See also #7 and Sections 6.3 and 6.4) K		
	First floor-to-floor height 12 feet (min.) (see #4) M		
	Ground floor finish level 12 inches max. above sidewalk (for ground floor commercial-ready buildings) L		
	Upper floor-to-floor height 10 feet (min.) (see #4) N		
	5.2.5 Commercial-ready Requirements	5.2.5 Commercial-ready Requirements Commercial-ready buildings are not required. Where non-residential or mixed-use buildings are constructed, see requirement for ground floor finish level in Height Standards above.	

5.0 SITE DEVELOPMENT STANDARDS

5.2.6 Parking and Service Access

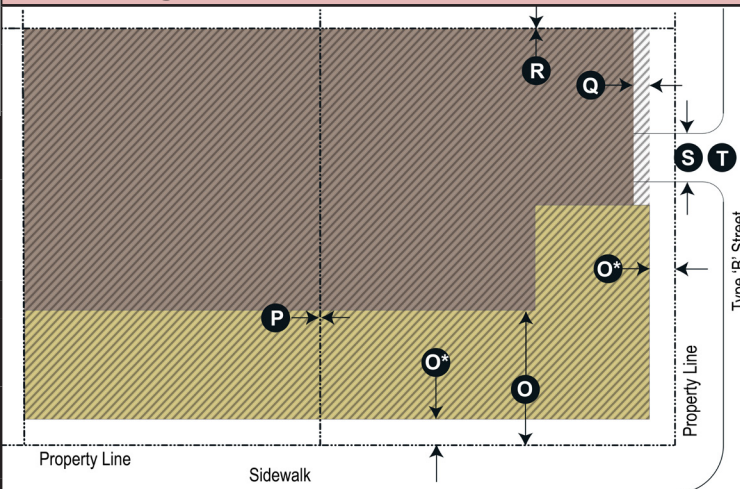

LEGEND

- Property Line
 - Setback Line
 - Building Area
 - Landscape Zone
 - Build-to Zone
 - Sidewalk
- * Not to scale

5.2.8 Façade Elements

- (i) *Doors and Windows:*
1. There shall be no blank walls greater than 50 feet in width of any building along **'A' Streets, Primary 'B' Streets, and Civic Spaces.** For **Secondary 'B' Streets** there is no requirement.
 2. Doors and windows on the ground floor of all buildings shall constitute a minimum of 30% of the ground floor façade area along all **'A' Streets and Civic Spaces.** Along **'B' Streets** there is no requirement.
 3. Windows on upper floor façades along all **'A' Streets and Civic Spaces** shall constitute a minimum of 20% of each upper floor façade area, which is measured between 3 feet and 9 feet above each finished floor.
 4. Primary entrance doors for all buildings shall be on **'A' Streets or Civic Spaces.**

(i) *Parking Location*

Surface/At-grade Parking [See also Section 6.8.4 starting on page 123]	
'A' Street/ Civic Space setback	Shall be located behind the principal building O
'B' Street setback	Min. of 3 feet behind building façade line along that street Q
Side and Rear setback (distance from property line)	0 feet min. (see Note # 2) P R
Above-grade Parking	
Setback along 'A' & 'B' Streets or Civic Space	May be built up to the building façade line along that street O*
Side and Rear setbacks (distance from property line)	0 feet min. (see Note # 2) P

(ii) *Required Off-Street Parking Spaces*

Non-residential uses within 250 feet of single-family residential	1 space per every 300 gross square feet
Residential Uses	1 space/unit minimum

(iii) *Driveways and Service Access*

Parking driveway width	City DPM standards on Arterial Roadways and 25 feet max. on all other streets S
<ul style="list-style-type: none"> • Driveways and off-street loading and unloading shall not be located on 'A' Streets or Civic Spaces. [See also Section 6.8.3 starting on page 123.] • Porte cocheres may be permitted on 'A' Streets to provide drop-off and valet service. • Shared driveways and cross access easements are encouraged between lots to minimize curb cuts. • If driveway and/or off-street service loading and unloading access is provided from an 'A' Street, such access is to be deemed as temporary, and cross access easements along the rear of the property may be required when adjoining properties are undeveloped. T 	

5.2.7 Other Standards

- (i) *Encroachments*
1. Canopies, signs, shade structures and balconies may encroach over the sidewalk as long as the vertical clearance is a minimum of 8 feet. In no case shall an **encroachment** be located over an on-street parking or travel lane. [See also **Section 11.2.8** starting on page 207.]
 2. Building projections on all other façades may not be closer than 5 feet to any **abutting** property line.
- (ii) *Arcades and Colonnades*
1. Arcades and **colonnades** are permitted within the **build-to zone** and shall be a minimum of 6 feet in depth.
 2. The minimum interior clearance height within an arcade or **colonnade** shall be 12 feet.
- (iii) *Walls and Fences:* Chain link fences and plastic vinyl fences shall not be permitted in the Regional Center Zone. [See also **Section 9.7.4** starting on page 156 for other design standards.]
- (iv) *General Site Development Standards:* See **Section 6.0** starting on page 109.

5.0 BUILDING DESIGN STANDARDS SU-2 VHRC

R

Building Design Standards Specific to Regional Center Character Zone: The following standards shall be used for new development or redevelopment within the Regional Center Zone.

5.2.9. **Intent/Purpose:** Building Design Standards provide performance-based requirements intended to result in high-quality development and pedestrian-friendly environment in order to provide predictability over time and along corridors for property owners, neighbors, investors, and the public.

5.2.10. **Guidelines**

- (i) Building entrances should be defined and articulated by architectural elements such as lintels, pediments, **pilasters**, columns, porticos, porches, overhangs, railings, balustrades, and others as appropriate. All building elements should be compatible with the architectural style, materials, colors, and details of the building as a whole. Entrances to upper level uses may be defined and integrated into the design of the overall building **façade**.
- (ii) Buildings should generally maintain the alignment of horizontal elements along the block.
- (iii) Architectural features emphasizing the corners of buildings, such as pedimented, gabled **parapets**; **cornices**; shade structures; **blade signs**; arcades; **colonnades**; projecting roofs, and balconies should be used along commercial storefronts to add pedestrian interest. [See **Examples A-C** for illustrations.]

5.2.11. **Massing and Façade Composition**

- (i) Buildings shall maintain a rhythm of **façade articulation** between 30-50 feet along all **'A' Streets** or **Civic Spaces**. This **articulation** rhythm may be expressed by changing materials or color; using design elements such as fenestration, columns, and **pilasters**; or varying the setback of portions of the **façade**.
- (ii) Buildings shall be designed and built with a distinct Base, Middle, and Cap.
- (iii) An expression line or equivalent architectural element shall delineate the Base and Cap of all buildings. A **parapet cornice** or equivalent architectural element shall delineate the caps of **façades** that do not use a pitched roof.
- (iv) Retail storefront buildings shall include a **transom**, display window area, and bulkhead at the base.
- (v) Storefronts on **façades** that span multiple tenants shall use architecturally compatible materials, colors, details, shade structures, signage, and lighting fixtures.
- (vi) Buildings located on axis with a terminating street or at the intersection of streets shall be considered feature buildings. Such buildings shall be designed with features that take advantage of that location, such as an accentuated entry and a unique building **articulation** off-set from the front wall planes that rises above the main building eave or **parapet** line.

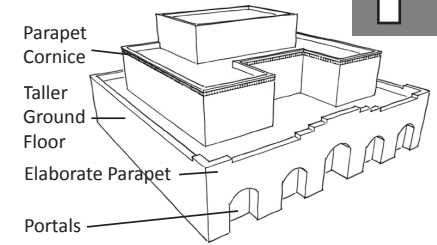

EXAMPLE A – PORTAL AND PARAPET

5

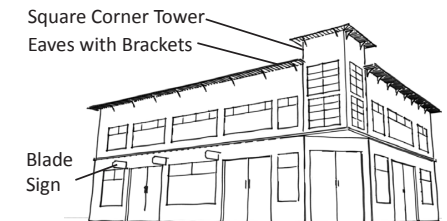

EXAMPLE B – EAVES AND TOWER ELEMENT

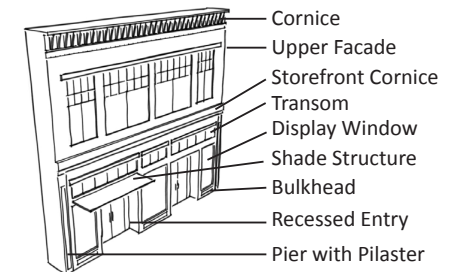

EXAMPLE C – STOREFRONT

5.0 BUILDING DESIGN STANDARDS

R

5

5.2.12. **Non-residential and Mixed-use Building Materials**

- (i) The following materials shall be permitted as principal building materials along all **'A' Street** or **Civic Space** fronting **façades**:
 - a. masonry, stone, cast stone, brick, glass, glass block, or stucco using a process other than a one-step process;
 - b. split face concrete block or pre-cast or poured-in-place concrete;
 - c. cementitious fiber clapboard (not sheet) with at least a 50-year warranty;
 - d. architectural metal panel (not including galvanized or unfinished metal); and/or
 - e. other primary building materials approved on a case-by-case basis by the Planning Director or his/her designee, particularly for buildings over 26 feet high.
- (ii) No more than 50% of each **façade** along any **'A' Street** shall use accent materials such as other metal finishes, wood, or **EIFS**.
- (iii) All **façades** along **'B' Streets** or **alleys** shall be of a similar finished quality and color that blend with the front of the building. Building materials for these façades may be any of the primary and accent façade materials listed above.
 - a. **EIFS** shall be limited to 40% of any 'B' Street- or alley-facing **façade**.
- (iv) Roofing materials visible from any public **ROW** shall be clay barrel tile, copper, factory finished standing seam metal, slate, synthetic slate, or similar materials.

5.2.13. **Residential Building Materials**

- (i) The following shall be permitted finishes for all street-fronting **façades** (except **alleys**) of residential buildings. No more than three (3) different materials shall be used on any single façade:
 - a. cementitious-fiber clapboard (not sheet) with at least a 50-year warranty;
 - b. masonry, brick, stone, man-made stone, or stucco using a process other than a one-step process.
- (ii) The following shall only be allowed up to 40% as an accent material:
 - a. **EIFS** or similar material over a cementitious base, rock, glass block and tile.
- (iii) Side and rear **façades** shall be of finished quality and of the same color and materials that blend with the front of the building.
- (iv) Other primary building materials shall be considered on a case-by-case basis by the Planning Director or his/her designee, particularly for buildings above 26 feet.
- (v) Roofing materials visible from any public **ROW** shall be clay barrel tile, copper, factory finished standing seam metal, slate, synthetic slate, or similar materials.

5.2.14. **Windows**

- (i) Glazing along **'A' Streets** shall not be opaque.
- (ii) To reduce mirror effect, windows shall be either glazing rated low-reflective value or a combination of glass and coating or finish to satisfy the equivalent standard. Highly reflective coatings and/or finishes are prohibited.

5.0 BUILDING DESIGN STANDARDS SU-2 VHRC

5.2.15. **Architectural Details and Other Elements**

At least one (1) of the following detail elements shall be incorporated to provide visual interest:

- (i) detailing around principal openings including but not limited to decorative trim, carving, transoms, columns, pilasters, pediments, and/or architraves,
- (ii) window details such as but not limited to window sills, decorative leading, color, opaque treatments, multipane windows, soldier course, transoms, and/or lintels,
- (iii) metal railings at balconies,
- (iv) shade structures,
- (v) roof towers,
- (vi) forecourts,
- (vii) fountains or water features using recycled or reclaimed water,
- (viii) plazas,
- (ix) pedestrian furniture and/or lifesize game boards,
- (x) masonry screen products for see-through walls or portions of walls,
- (xi) free-standing arbors, canopies, or towers,
- (xii) tower elements, and/or
- (xiii) other equivalent element, as approved by the Planning Director or his/her designee.

R

5

5.0 Site Development and Building Design Standards

R



5



5.3. Village Center Zone

5.3.1. Illustrations and Intent

Note: These are provided as illustrations of intent. The illustrations and statements on this page are advisory only and do not have the power of law. Refer to the standards on the following pages for the specific regulatory Site Development Standards.

The Village Center Zone site development standards are intended to address development at a proposed node on the northwest corner of the Plan area, mirroring a Village Center across Universe Boulevard in Volcano Trails. Development standards in this **character zone** are intended to create conditions for a Village Center to serve development in the surrounding Mixed Use Zone.

Generally, this **character zone** accommodates higher-density development near an intersection of **Primary Streets**. The goal is to provide slightly higher-density development to add gravity for surrounding development in the Mixed Use Zone. The limited size of the zone should accommodate a range of commercial, retail, and urban residential development with smaller footprints than the surrounding Mixed Use but eligible for heights up to 60 feet with the optional height bonus.

In addition, the required site development pattern of building pads, parking, driveways, and service areas is intended to provide opportunities for short-term development while allowing for planned urban block infill development in the long-term.

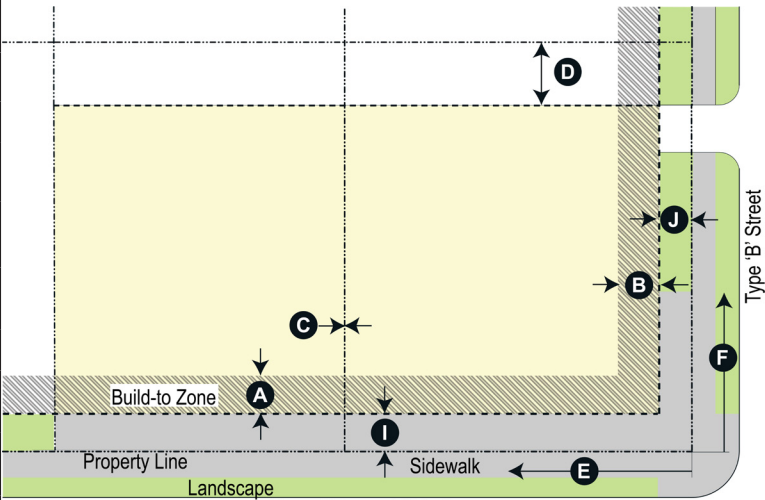
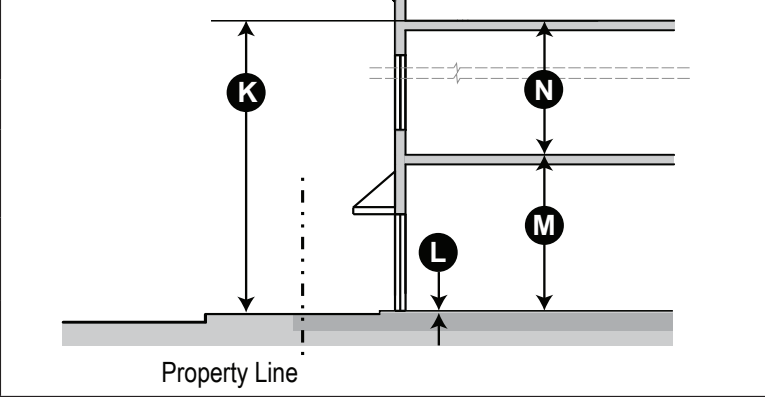

5.0 SITE DEVELOPMENT STANDARDS SU-2 VHVC

5.3.2 Building Placement	(i) Build-To Zone (BTZ) [measured from setback]	Notes	
 <p>LEGEND</p> <ul style="list-style-type: none"> Property Line (dashed line) Setback Line (dotted line) Building Area (yellow) Landscape Zone (green) Build-to Zone (hatched) Sidewalk (grey) <p>* Not to scale</p>	Front (if 'A' Street and/or Civic Space) 0 – 10 feet (see #1) A	#1 – Area between the building and the edge of the BTZ at the sidewalk shall be paved flush with the public sidewalk. Where topography poses challenges, a majority of the sidewalk shall be provided at the level of the building, with appropriate approved transitions to the changed topography level.	
	Front (if 'B' Street) 0 – 20 feet B		
	(ii) Setback [measured from property line]		
	Front (if 'A' Street and/or Civic Space) 5 feet (max.) I	#2 – Side and rear setbacks shall be based on minimum fire separation required between buildings, if applicable.	
	Front (if 'B' Street) 10 feet (max.) J		
	Side or Rear (distance from property line) 0 feet (min.) (see #2) C D	#3 – Corner building street façades shall be built to the BTZ for a minimum of 30 feet from the corner along both streets or the width of the corner lot, whichever is less. Recessed entrances are permitted as long as the upper floors meet the BTZ standards.	
	(iii) Building Frontage Required		
	% of building built to 'A' Street/Civic Space BTZ 60% (min.) (see #3 and #6) E	#4 – Floor to floor heights shall not apply to parking structures.	
	% of building built to 'B' Street BTZ 30% (min.) (see #3 and #6) F		
	5.3.3 Block Standards	[for development/redevelopment > 50% of the block]	
	Block Face Dimensions 300 feet (min.) 700 feet (max.)	#5 – Attics and mezzanines less than 7 feet (avg.) in height shall not be counted as a story.	
	Block Perimeter 2000 feet (max.)	#6 – Civic open space within the BTZ shall count toward the frontage requirement.	
5.3.4 Height Standards	Height Standards		
	Maximum structure height 3 stories or 40 feet (max.) (See also #7 and Sections 6.3 and 6.4) K	#7 – Corner buildings may exceed the maximum building height by 15% for 20% of the building's frontage along each corresponding street façade.	
	First floor-to-floor height 12 feet (min.) (see #4) M		
	Ground Floor finish level 12 inches max. above sidewalk (for ground floor commercial-ready buildings) L		
	Upper floor-to-floor height 10 feet (min.) (see #4) N		
5.3.5 Commercial-ready Requirements			
	Commercial-ready buildings are not required. Where non-residential or mixed-use buildings are constructed, see requirement for ground floor finish level in Height Standards above.		

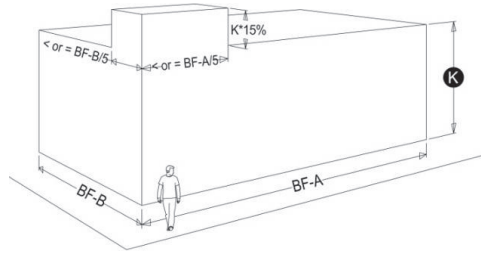

5.0 SITE DEVELOPMENT STANDARDS

<p>5.3.6 Parking and Service Access</p>	<p><i>(i) Parking Location</i></p>	<p>5.3.7 Other Standards</p>																					
<p>LEGEND</p> <ul style="list-style-type: none"> Property Line Surface Parking Area Building Footprint Above Grade Parking Area <p><i>* Not to scale</i></p>	<p>Surface/At-grade Parking [See also Section 6.8.4 starting on page 123]</p> <table border="1"> <tr> <td>'A' Street/ Civic Space setback</td> <td>Shall be located behind the principal building</td> <td>O</td> </tr> <tr> <td>'B' Street setback</td> <td>Min. of 3 feet behind building façade line along that street</td> <td>Q</td> </tr> <tr> <td>Side and Rear setback (<i>distance from property line</i>)</td> <td>0 feet (min.) (see # 2)</td> <td>P R</td> </tr> </table> <p>Above-grade Parking</p> <table border="1"> <tr> <td>Setback along 'A' & 'B' Streets or Civic Space</td> <td>May be built up to the building façade line along that street</td> <td>O*</td> </tr> <tr> <td>Side and Rear setbacks (<i>distance from property line</i>)</td> <td>0 feet min. (see # 2)</td> <td>P</td> </tr> </table> <p><i>(ii) Required Off-Street Parking Spaces</i></p> <table border="1"> <tr> <td>Non-residential uses within 250 feet of single-family residential</td> <td>1 space per every 300 gross square feet</td> <td></td> </tr> <tr> <td>Residential Uses</td> <td>None</td> <td></td> </tr> </table>	'A' Street/ Civic Space setback	Shall be located behind the principal building	O	'B' Street setback	Min. of 3 feet behind building façade line along that street	Q	Side and Rear setback (<i>distance from property line</i>)	0 feet (min.) (see # 2)	P R	Setback along 'A' & 'B' Streets or Civic Space	May be built up to the building façade line along that street	O*	Side and Rear setbacks (<i>distance from property line</i>)	0 feet min. (see # 2)	P	Non-residential uses within 250 feet of single-family residential	1 space per every 300 gross square feet		Residential Uses	None		<p><i>(i) Encroachments</i></p> <ol style="list-style-type: none"> Canopies, signs, shade structures and balconies may encroach over the sidewalk as long as the vertical clearance is a minimum of 8 feet. In no case shall an encroachment be located over an on-street parking or travel lane. [See also Section 11.2.8 starting on page 207.] Building projections on all other façades may not be closer than 5 feet to any abutting property line. <p><i>(ii) Arcades and Colonnades</i></p> <ol style="list-style-type: none"> Arcades and colonnades are permitted within the build-to zone and shall be a minimum of 6 feet in depth. The minimum interior clearance height within an arcade or colonnade shall be 12 feet. <p><i>(iii) Walls and Fences:</i> Chain link fences and plastic vinyl fences shall not be permitted in the Village Center Zone. [See also Section 9.7.4 starting on page 156 for other design standards.]</p> <p><i>(iv) General Site Development Standards:</i> See Section 6.0 starting on page 109.</p>
'A' Street/ Civic Space setback	Shall be located behind the principal building	O																					
'B' Street setback	Min. of 3 feet behind building façade line along that street	Q																					
Side and Rear setback (<i>distance from property line</i>)	0 feet (min.) (see # 2)	P R																					
Setback along 'A' & 'B' Streets or Civic Space	May be built up to the building façade line along that street	O*																					
Side and Rear setbacks (<i>distance from property line</i>)	0 feet min. (see # 2)	P																					
Non-residential uses within 250 feet of single-family residential	1 space per every 300 gross square feet																						
Residential Uses	None																						
<p>5.3.8 Façade Elements</p>	<p><i>(iii) Driveways and Service Access</i></p>																						
<p><i>(i) Doors and Windows:</i></p> <ol style="list-style-type: none"> There shall be no blank walls greater than 25 feet in width of any building along 'A' Streets and Civic Spaces. There shall be no blank walls greater than 50 feet in width of any building along Primary 'B' Streets. For Secondary 'B' Streets there is no requirement. Doors and windows on the ground floor of all buildings shall constitute between 50% and 90% of the ground floor façade area along all 'A' Streets and Civic Spaces. Along 'B' Streets there is no requirement. Windows on upper floor façades along all 'A' Streets and Civic Spaces shall constitute a minimum of 25% of each upper floor façade area, which is measured between 3 feet and 9 feet above each finished floor. Primary entrance doors for all buildings shall be on 'A' Streets or Civic Spaces. <p><i>(ii) Façade Articulation:</i> Along Paseo del Norte, façades shall incorporate a corner element, articulated by a horizontal break of 3 feet max.</p>	<table border="1"> <tr> <td>Parking driveway width</td> <td>City DPM standards on Arterial Roadways and 25 feet max. on all other streets</td> <td>S</td> </tr> </table> <ul style="list-style-type: none"> Driveways and off-street loading and unloading shall not be located on 'A' Streets or Civic Spaces. [See also Section 6.8.3 starting on page 123.] Porte cocheres may be permitted on 'A' Streets to provide drop-off and valet service. Shared driveways and cross access easements are encouraged between lots to minimize curb cuts. If driveway and/or off-street service loading and unloading access is provided from an 'A' Street, such access is to be deemed as temporary, and cross access easements along the rear of the property may be required when adjoining properties are undeveloped. 	Parking driveway width	City DPM standards on Arterial Roadways and 25 feet max. on all other streets	S																			
Parking driveway width	City DPM standards on Arterial Roadways and 25 feet max. on all other streets	S																					

5.0 BUILDING DESIGN STANDARDS SU-2 VHVC

R

Building Design Standards Specific to Village Center Character Zone: The following standards shall be used for new development or redevelopment within the Village Center Zone.

5.3.9. **Intent/Purpose:** Building Design Standards provide performance-based requirements intended to result in high-quality development and pedestrian-friendly environment in order to provide predictability over time and along corridors for property owners, neighbors, investors, and the public.

5.3.10. **Guidelines**

- (i) Buildings should generally have a rectangular layout scheme with single or multiple components with mostly flat front and square, round, or octagonal corner towers.
- (ii) Building **façades** may be symmetrical or asymmetrical, but the central part of the building should be expressed with well-balanced façade compositions.
- (iii) The ground floor should be taller and include heavier massing than floors above. An arcade or **colonnade** may be incorporated. [See **Examples A** for illustration.]
- (iv) Storefronts should be inset with recessed entry, under the **portal**, arcade, or fit into arches openings, often with shade structures. [See **Examples A-C** for illustrations.]
- (v) Shade structures, **blade signs**, arcades, **galleries**, café seating and balconies should be used along commercial storefronts fronting an **'A' Street** or **Civic Space** to add pedestrian interest. [See **Examples B & C** for illustrations.]

5.3.11. **Massing and Façade Composition**

- (i) Buildings shall maintain a prevalent **façade articulation** rhythm of 20-30 feet or multiples thereof along all **'A' Streets** or **Civic Spaces**. This **articulation** rhythm may be expressed by changing materials or color, using design elements such as columns and **pilasters**, or varying the setback of portions of the building **façade**.
- (ii) Doors or windows shall form regular patterns of openings, some accentuated by balconies.
- (iii) Commercial and mixed-use building **façades** shall be designed with a distinct base, middle, and cap and shall maintain the alignment of horizontal elements along the block.
- (iv) If a single-family building is set back less than 10 feet from the front property line, the grade of the slab or first floor elevation shall be elevated at least 18 inches above the grade of the sidewalk. If a single-family structure is set back 10 feet or more from the property line and is not elevated at least 18 inches above the grade of the sidewalk, a 3-foot high fence shall be provided at the front property line.

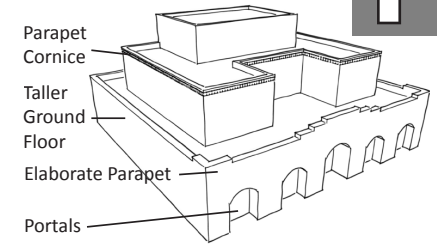

EXAMPLE A – PORTAL AND PARAPET

5

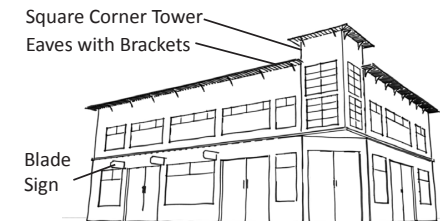

EXAMPLE B – EAVES AND TOWER ELEMENT

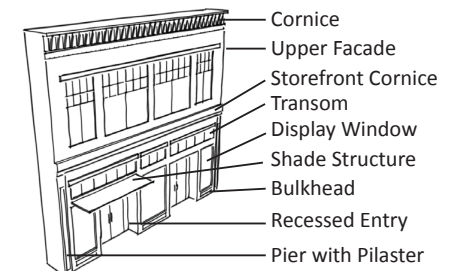

EXAMPLE C – STOREFRONT

5.0 BUILDING DESIGN STANDARDS



5.3.12. **Building Materials**

- (i) At least 60% of a building's **façade** along all **'A' Streets** or **Civic Spaces** shall be composed of masonry, brick, or stucco using a process other than a one-step process.
- (ii) No more than 40% of a building's **façade** along all **'A' Streets** or **Civic Spaces** shall use other accent materials wood, architectural metal panel, split-face concrete block, tile, or pre-cast concrete panels. **EIFS** shall not be permitted along any **'A' Street** or **Civic Space** façade.
- (iii) All **façades** along **'B' Streets** or **alleys** shall be of a similar finished quality and color that blend with the front of the building. Building materials for these façades may be any of the primary and accent façade materials listed above.
 - a. **EIFS** shall be limited to no more than 10% of the upper floor **façades** along **'B' Streets** and **alleys**.
 - b. Cementitious-fiber clapboard (not sheet) with at least a 50-year warranty may only be used on the upper floors of any **'B' Street** or **alley façades**.
- (iv) Other primary building materials shall be considered on a case-by-case basis by the Planning Director or his/her designee, particularly for buildings above 26 feet.
- (v) Roofing materials visible from any public **ROW** shall be clay tile, copper, factory finished standing seam or corrugated metal, metal shingle, slate, synthetic slate, or similar materials.

5.3.13. **Windows**

- (i) Glazing along **'A' Streets** shall not be opaque.
- (ii) To reduce mirror effect, windows shall be either glazing rated low-reflective value or a combination of glass and coating or finish to satisfy the equivalent standard. Highly reflective coatings and/or finishes are prohibited.
- (iii) Ornamental arches of various designs, where used, shall be deeper on the ground floor and shallower on upper floors.

5.3.14. **Architectural Details and Other Elements**

- At least two (2) of the following detail elements shall be incorporated to provide visual interest:
- (i) detailing around principal openings including but not limited to decorative trim, carving, transoms, columns, pilasters, pediments, and/or architraves,
 - (ii) window details such as but not limited to window sills, decorative leading, color, opaque treatments, multipane windows, soldier course, transoms, and/or lintels,
 - (iii) metal railings at balconies,
 - (iv) shade structures,
 - (v) roof towers,
 - (vi) forecourts,
 - (vii) fountains or water features using recycled or reclaimed water,
 - (viii) plazas,
 - (ix) pedestrian furniture and/or lifesize game boards,
 - (x) masonry screen products for see-through walls or portions of walls,
 - (xi) free-standing arbors, canopies, or towers,
 - (xii) tower elements, and/or
 - (xiii) other equivalent element, as approved by the Planning Director or his/her designee.

5.0 Site Development and Building Design Standards SU-2 VHMX

5.4. Mixed-Use Zone

5.4.1. Illustrations and Intent

Note: These are provided as illustrations of intent. The illustrations and statements on this page are advisory only and do not have the power of law. Refer to the standards on the following pages for the specific Site Development Standards.

The Mixed-use Zone site development standards are intended to address development throughout Volcano Heights. Development standards in this zone are intended to take advantage of the large parcels with access to regional connectors and a proposed Transit Boulevard.

Generally, this zone may accommodate large-format office sites with surface parking within the interior of the lot/block and screened from public view along **'A' Streets**. The goal is to minimize the impact of large, surface parking lots and encourage an "office park" look.

In addition, required site development pattern of building pads, parking, driveways, and service areas is intended to provide opportunities for short-term development while allowing for planned urban block infill development in the long-term as the market can accommodate it.

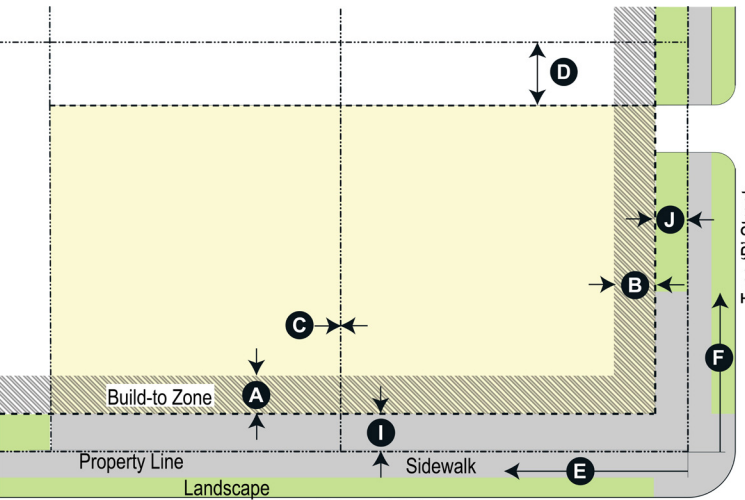
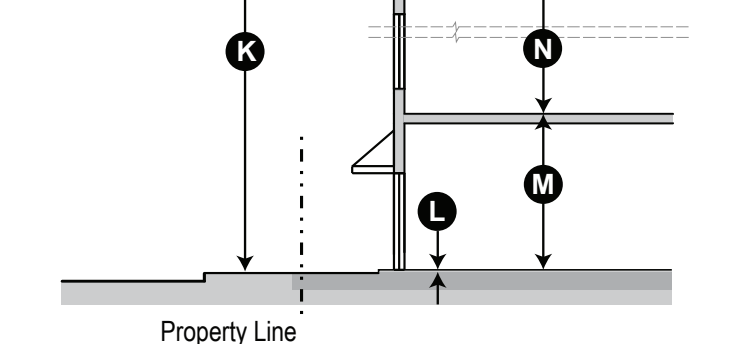
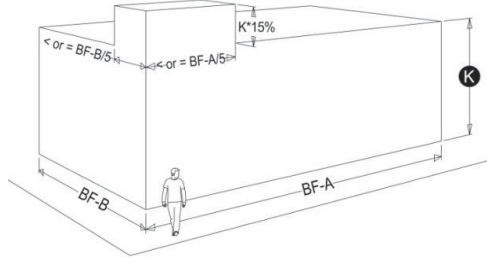

5.4.2 Building Placement	(i) Build-To Zone (BTZ) [measured from setback]	Notes	
 <p>LEGEND</p> <ul style="list-style-type: none"> Property Line (dashed line) Setback Line (dotted line) Building Area (yellow) Landscape Zone (green) Build-to Zone (hatched) Sidewalk (grey) <p>Type 'A' Street / Civic Space * Not to scale</p>	Front (if 'A' Street and/or Civic Space) 0 – 15 feet (see #1) A	#1 – Area between the building and the edge of the BTZ at the sidewalk shall be paved flush with the public sidewalk. Where topography poses challenges, a majority of the sidewalk shall be provided at the level of the building, with appropriate approved transitions to the changed topography level.	
	Front (if 'B' Street) 0 – 20 feet B		
	(ii) Setback [measured from property line]		
	Front (if 'A' Street and/or Civic Space) 5 feet (max.) I	#2 – Side and rear setbacks shall be based on minimum fire separation required between buildings, if applicable.	
	Front (if 'B' Street) 10 feet (max.) J		
	Side or Rear (distance from property line) 0 feet (min.) (see #2 and Section 5.4.7(iii)) C D	#3 – Corner building street façades shall be built to the BTZ for a minimum of 25 feet from the corner along both streets or the width of the corner lot, whichever is less. Recessed entrances are permitted as long as the upper floors meet the BTZ standards.	
	(iii) Building Frontage Required		
	% of building built to 'A' Street/Civic Space BTZ 50% (min.) (see #3 and #6) E	#4 – Floor to floor heights shall not apply to parking structures.	
	% of building built to 'B' Street BTZ 25% (min.) (see #3 and #6) F		
	5.4.3 Block Standards [for development/redevelopment > 50% of the block]	5.4.3 Block Standards [for development/redevelopment > 50% of the block]	
5.4.4 Height Standards	Height Standards		
	Block Face Dimensions 300 feet (min.) / 1200 feet (max.)	#5 – Attics and mezzanines less than 7 feet (avg.) in height shall not be counted as a story.	
	Block Perimeter 3600 feet (max.)	#6 – Civic open space within the BTZ shall count toward the frontage requirement.	
	Maximum structure height 2 stories or 26 feet (max.) (See also #7 and Sections 6.3 and 6.4) K	#7 – Corner buildings may exceed the maximum building height by 15% for 20% of the building's frontage along each corresponding street façade.	
	First floor-to-floor height 12 feet (min.) (see #4) M		
	Ground Floor finish level (for ground floor commercial-ready buildings) 12 inches max. above sidewalk L		
5.4.5 Commercial-ready Requirements	Upper floor-to-floor height 10 feet (min.) (see #4) N		
Commercial-ready buildings are not required. Where non-residential or mixed-use buildings are constructed, see requirement for ground floor finish level in Height Standards above.			

5.0 SITE DEVELOPMENT STANDARDS SU-2 VHMX

5.4.6 Parking and Service Access

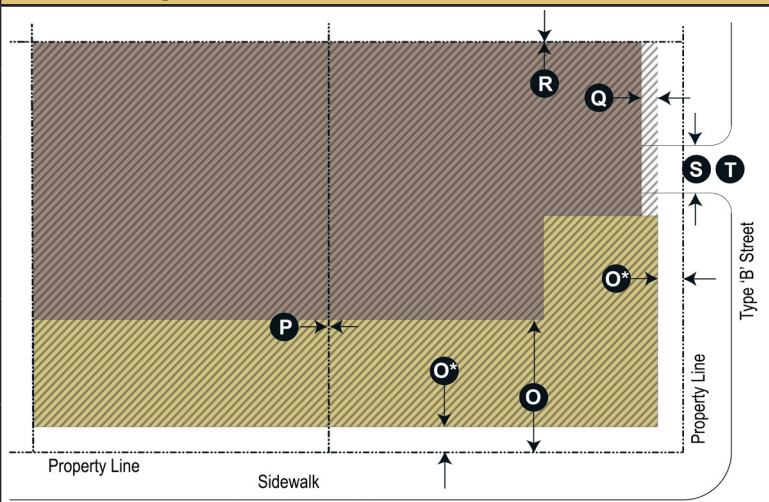

LEGEND

- Property Line
- Building Footprint
- Surface Parking Area
- Above Grade Parking Area

* Not to scale

5.4.8 Façade Elements

(i) *Doors and Windows:*

- There shall be no blank walls greater than 50 feet in width of any building along 'A' Streets, Primary 'B' Streets, and Civic Spaces. For Secondary 'B' Streets there is no requirement.
- Doors and windows on the ground floor of all buildings shall constitute a minimum of 30% of the ground floor façade area along all 'A' Streets and Civic Spaces. Along 'B' Streets there is no requirement.
- Windows on upper floor façades along all 'A' Streets and Civic Spaces shall constitute a minimum of 20% of each upper floor façade area, which is measured between 3 feet and 9 feet above each finished floor.
- Primary entrance doors for all buildings shall be on 'A' Streets or Civic Spaces.

(ii) *Façade Articulation:* Along Unser Boulevard and Paseo del Norte, façades shall incorporate a corner element, articulated by a horizontal break of 3 feet max.

(i) Parking Location

Surface/At-grade Parking [See also Section 6.8.4 starting on page 123]	
'A' Street/ Civic Space setback	Shall be located behind the principal building O
'B' Street setback	Min. of 3 feet behind building façade line along that street Q
Side and Rear setback (distance from property line)	0 feet min. (see # 2 and Section 5.4.7(iii)) P R
Above-grade Parking	
Setback along 'A' & 'B' Streets or Civic Space	May be built up to the building façade line along that street O*
Side and Rear setbacks (distance from property line)	0 feet (min.) (see # 2 and Section 5.4.7(iii)) P

(ii) Required Off-Street Parking Spaces

Non-residential uses within 250 feet of single-family residential	1 space per every 400 gross square feet
Residential Uses	1 space/unit minimum

(iii) Driveways and Service Access

Parking driveway width	City DPM standards on Arterial Roadways and 25 feet max. on all other streets S
<ul style="list-style-type: none"> Driveways and off-street loading and unloading shall not be located on 'A' Streets or Civic Spaces. [See also Section 6.8.3 starting on page 123.] Porte cocheres may be permitted on 'A' Streets to provide drop-off and valet service. Shared driveways and cross access easements are encouraged between lots to minimize curb cuts. If driveway and/or off-street service loading and unloading access is provided from an 'A' Street, such access is to be deemed as temporary, and cross access easements along the rear of the property may be required when adjoining properties are undeveloped. 	T

5.4.7 Other Standards

- (i) *Encroachments*
- Canopies, signs, shade structures and balconies may encroach over the sidewalk as long as the vertical clearance is a minimum of 8 feet. In no case shall an **encroachment** be located over an on-street parking or travel lane. [See also Section 11.2.8 starting on page 207.]
 - Building projections on all other façades may not be closer than 5 feet to any **abutting** property line.
- (ii) *Arcades and Colonnades*
- Arcades and **colonnades** are permitted within the **build-to zone** and shall be a minimum of 6 feet in depth.
 - The minimum interior clearance height within an arcade or **colonnade** shall be 12 feet
- (iii) *Buffers for Detached Single-family Housing*
- A buffer shall be established on all development sites **adjacent** to single family detached residential lots at 25 feet parallel to any lot line that is common with a single-family detached residential lot.
 - Building height** within this buffer shall not exceed 2 floors or 26 feet and is not eligible for height bonus. This standard shall apply to any parking structures located within the buffer.
 - A privacy fence (masonry or opaque vegetation combined with fence or wall) 6 feet high shall be required when **abutting** a single-family residential lot and shall be optional for all other adjacencies. See also Section 9.7.4 starting on page 156 for wall design requirements.

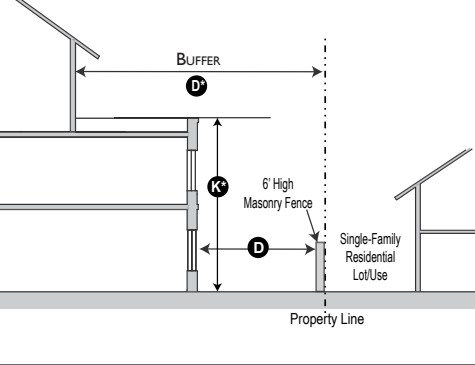

5.0 BUILDING DESIGN STANDARDS

R

Building Design Standards Specific to Mixed-Use Character Zone: The following standards shall be used for new development or redevelopment within the Mixed Use Zone.

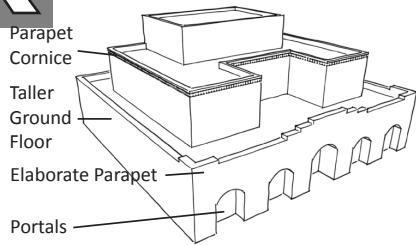

EXAMPLE A – PORTAL AND PARAPET

5

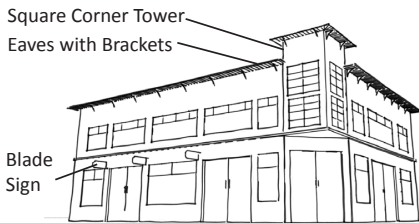

EXAMPLE B – EAVES AND TOWER ELEMENT

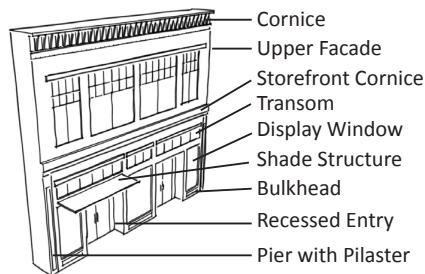

EXAMPLE C – STOREFRONT

5.4.9. **Intent/Purpose:** Building Design Standards provide performance-based requirements intended to result in high-quality development and pedestrian-friendly environment in order to provide predictability over time and along corridors for property owners, neighbors, investors, and the public.

5.4.10. **Guidelines**

(i) Building entrances should be defined and articulated by architectural elements such as lintels, pediments, **pilasters**, columns, porticos, porches, overhangs, railings, balustrades, and/or others as appropriate. All building elements should be compatible with the architectural style, materials, colors, and details of the building as a whole. Entrances to upper level uses may be defined and integrated into the design of the overall building **façade**.

(ii) Buildings should generally maintain the alignment of horizontal elements along the block.

(iii) Architectural features emphasizing the corner of the building, such as use of pediments, gabled **parapets**; **cornices**; shade structures; **blade signs**; arcades; **colonnades**; and balconies should be used along commercial storefronts to add pedestrian interest. [See **Examples A-C** for illustrations.]

5.4.11. **Façade Composition**

- (i) Buildings shall maintain a **façade articulation** rhythm of 20-30 feet along all **'A' Streets** and **Civic Spaces** and 30-50 feet for façades along Paseo del Norte or Unser Boulevard. This **articulation** rhythm may be expressed by changing materials or color; using design elements such as fenestration, columns, and **pilasters**; or varying the setback of portions of the **façade**.
- (ii) Buildings shall be designed and built with a distinct Base, Middle, and Cap.
- (iii) Retail storefront buildings shall include a **transom**, display window area, and bulkhead at the base.
- (iv) Storefronts on **façades** that span multiple tenants shall use architecturally compatible materials, colors, details, shade structures, signage, and lighting fixtures.

5.0 BUILDING DESIGN STANDARDS SU-2 VHMX

5.4.12. **Non-residential and Mixed-use Building Materials**

- (i) At least 60% of each building's base **façade** (excluding doors and windows) along any '**A**' **Street** shall be finished in one of the following materials:
 - a. masonry, stone, cast stone, brick, glass, glass block, or stucco using a process other than one-step process;
 - b. hardi plank;
 - c. split face concrete block or pre-cast, or poured in place concrete;
 - d. cementitious fiber clapboard; and/or
 - e. other primary building materials approved by the Planning Director or his/her designee on a case-by-case basis.
- (ii) No more than 40% of each **façade** along any '**A**' **Street** shall use accent materials such as wood, architectural metal panel, or **EIFS**.
 - a. Cementitious-fiber clapboard shall be prohibited on mixed-use frontages. On the upper floors of any commercial frontage, no more than 20% of a '**B**' **Street** or **alley façade** may be cementitious-fiber clapboard (not sheet), which shall have at least a 50-year warranty.
- (iii) Roofing materials visible from any public **ROW** shall be factory-finished standing seam metal, slate, synthetic slate, or similar materials.

5.4.13. **Residential Building Materials**

- (i) The following shall be permitted finishes for all street fronting **façades** (except **alleys**) of residential buildings. No more than three (3) different materials shall be used on any single façade:
 - a. cementitious-fiber clapboard (not sheet) with at least a 50-year warranty;
 - b. lap sided wood;
 - c. masonry, brick, stone, man-made stone, or stucco using a process other than a one-step process;
 - d. architectural metal panels;
 - e. hardi plank; and/or
 - f. other primary building materials approved by the Planning Director or his/her designee on a case-by-case basis.
- (ii) The following shall only be allowed up to 40% as an accent material:
 - a. **EIFS** or similar material over a cementitious base, rock, glass block, and tile.
- (iii) Side and rear **façades** shall be of finished quality and of the same color and materials that blend with the front of the building.
- (iv) Roofing materials visible from any public **ROW** shall be clay barrel tile, copper, factory finished standing seam metal, slate, synthetic slate, or similar materials.

5.0 BUILDING DESIGN STANDARDS

R

5

5.4.14. **Windows**

- (i) Glazing along **'A' Streets** shall not be opaque.
- (ii) To reduce mirror effect, windows shall be either glazing rated low-reflective value or a combination of glass and coating or finish to satisfy the equivalent standard. Highly reflective coatings and/or finishes are prohibited.
- (iii) Ornamental arches of various designs, where used, shall be deeper on the ground floor and shallower on upper floors.

5.4.15. **Architectural Details and Other Elements**

At least one (1) of the following detail elements shall be incorporated to provide visual interest:

- (i) detailing around principal openings including but not limited to decorative trim, carving, transoms, columns, pilasters, pediments, and/or architraves,
- (ii) window details such as but not limited to window sills, decorative leading, color, opaque treatments, multipane windows, soldier course, transoms, and/or lintels,
- (iii) metal railings at balconies,
- (iv) shade structures,
- (v) roof towers,
- (vi) forecourts,
- (vii) fountains or water features using recycled or reclaimed water,
- (viii) plazas,
- (ix) pedestrian furniture and/or lifesize game boards,
- (x) masonry screen products for see-through walls or portions of walls,
- (xi) free-standing arbors, canopies, or towers,
- (xii) tower elements, and/or
- (xiii) other equivalent element, as approved by the Planning Director or his/her designee.

5.0 Site Development and Building Design Standards SU-2 VHET

5.5. Escarpment Transition

5.5.1. Illustrations and Intent

Note: These are provided as illustrations of intent. The illustrations and statements on this page are advisory only and do not have the power of law. Refer to the standards on the following pages for the specific Site Development Standards.

The Escarpment Transition Zone site development standards are intended to address development between character zones toward the center of the Plan area and the Petroglyph National Monument east of the Plan boundary. Development standards in this district are intended to blend the areas between development and **Major Public Open Space**, as well as stepping down the intensity of uses and building heights closer to the Monument boundary.

Generally, this zone may accommodate low-rise commercial, single-family development, and limited urban residential development. The goal is to have a reasonable buffer between development and **sensitive lands** to the east.

In addition, Escarpment Transition sites shall be planned in such a manner as to facilitate low-intensity, residential-scale office, retail, and **live-work** buildings in a 1-2 story environment that accommodates natural topography, terrain, and natural environment.

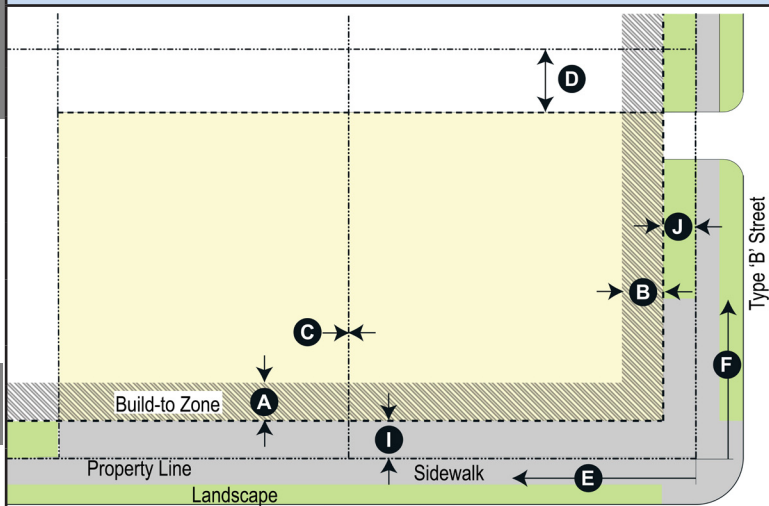
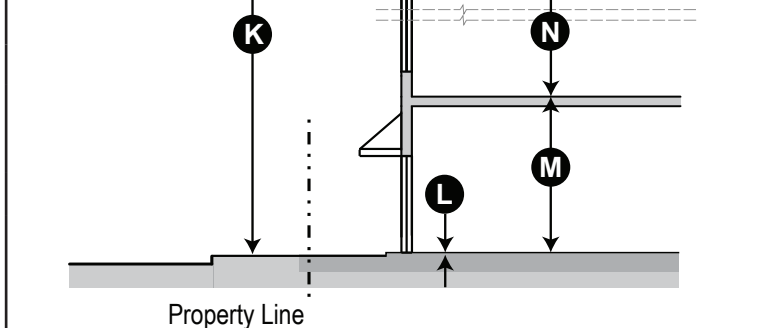

5.0 SITE DEVELOPMENT STANDARDS

5.5.2 Building Placement	(i) Build-To Zone (BTZ) [measured from setback]	Notes
 <p>LEGEND</p> <ul style="list-style-type: none"> Property Line (dashed line) Setback Line (dotted line) Building Area (yellow) Landscape Zone (green) Build-to Zone (hatched) Sidewalk (grey) <p>* Not to scale</p>	Front (if 'A' Street and/or Civic Space) 0 – 10 feet (see #1) A	#1 – Area between the building and the edge of the BTZ at the sidewalk shall be paved flush with the public sidewalk. Where topography poses challenges, a majority of the sidewalk shall be provided at the level of the building, with appropriate approved transitions to the changed topography level.
	Front (if 'B' Street) 0 – 20 feet B	#2 – Side and rear setbacks shall be based on minimum fire separation required between buildings, if applicable.
	(ii) Setback [measured from property line]	#3 – Corner building street façades shall be built to the BTZ for a minimum of 25 feet from the corner along both streets or the width of the corner lot, whichever is less. Recessed entrances are permitted as long as the upper floors meet the BTZ standards.
	Front (if 'A' Street and/or Civic Space) 5 feet (max.) I	#4 – Attics and mezzanines less than 7 feet (avg.) in height shall not be counted as a story.
	Front (if 'B' Street) 10 feet (max.) J	#5 – Civic open space within the BTZ shall count toward the frontage requirement.
	Side or Rear (distance from property line) 0 feet (min.) (see Note # 2) C D	#6 – Corner buildings may exceed the maximum building height by 15% for 20% of the building's frontage along each corresponding street façade.
	(iii) Building Frontage Required	
	% of building built to 'A' Street/Civic Space BTZ 60% (min.) (see #3 and #6) E	
	% of building built to 'B' Street BTZ 30% (min.) (see #3 and #6) F	
	5.5.3 Block Standards [for development/redevelopment > 50% of the block]	Height Standards
5.5.4 Height Standards	Maximum structure height 2 stories or 26 feet (max.) (See also #6 and Section 6.3) K	
	First floor-to-floor height 12 feet (min.) (see #4) M (Non-residential and Mixed Use only)	
	Ground Floor finish level 12 inches max. above sidewalk (for ground floor commercial-ready buildings) L	
	Upper floor-to-floor height 10 feet (min.) (see #4) N (Non-residential and Mixed Use only)	

5.0 SITE DEVELOPMENT STANDARDS SU-2 VHET

5.5.5 Parking and Service Access

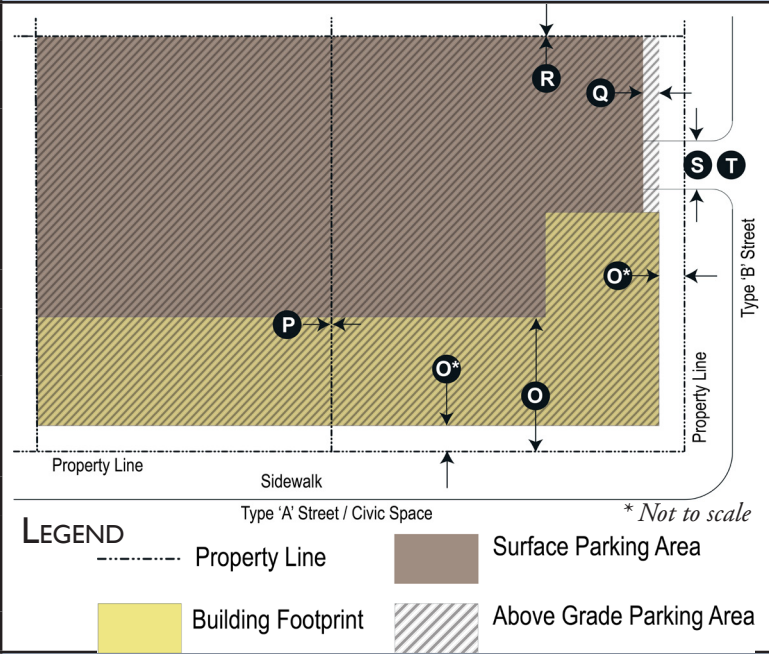

5.5.7 Façade Elements

(i) *Doors and Windows:*

1. There shall be no blank walls greater than 30 feet in width of any building along 'A' Streets and Civic Spaces. For 'B' Streets there is no requirement.
2. Doors and windows on ground floor of all buildings shall be a minimum of 25% of the ground floor façade area along all 'A' Streets and Civic Spaces. Along 'B' Streets there is no requirement.
3. Windows on upper floor façades along all 'A' Streets and Civic Spaces shall be a minimum of 20% of each upper floor façade area, which is measured between 3-9 feet above each finished floor.
4. Primary entrance doors for all buildings shall be on 'A' Streets or Civic Spaces.

(i) Parking Location

Surface/At-grade Parking [See Section 6.8.4 starting on page 123]	
'A' Street/ Civic Space setback	Shall be located behind the principal building O
'B' Street setback	Min. of 3 feet behind building façade line along that street Q
Side and Rear setback (distance from property line)	0 feet min. (see # 2) P R
Above-grade Parking	
Setback along 'A' & 'B' Streets or Civic Space	May be built up to the building façade line along that street O*
Side and Rear setbacks (distance from property line)	0 feet min. (see Note # 2) P

(ii) Required Off-Street Parking Spaces

Non-residential uses within 250 feet of single-family residential	1 space per every 300 gross square feet
Residential Uses	1 space/unit minimum

(iii) Driveways and Service Access

Parking driveway width	City DPM standards on Arterial Roadways and 25 feet max. on all other streets S
• Driveways and off-street loading and unloading shall not be located on 'A' Streets or Civic Spaces. [See also Section 6.8.3 starting on page 123.]	T
• Porte cocheres may be permitted on 'A' Streets to provide drop-off and valet service.	
• Shared driveways and cross access easements are encouraged between lots to minimize curb cuts.	
• If driveway and/or off-street service loading and unloading access is provided from an 'A' Street, such access is to be deemed as temporary, and cross access easements along the rear of the property may be required when adjoining properties are undeveloped.	

5.5.6 Other Standards

- (i) *Encroachments*
1. Canopies, signs, shade structures and balconies may encroach over the sidewalk as long as the vertical clearance is a minimum of 8 feet. In no case shall an **encroachment** be located over an on-street parking or travel lane. [See also Section 11.2.8 starting on page 207.]
 2. Building projections on all other façades may not be closer than 5 feet to any **abutting** property line.
- (ii) *Arcades and Colonnades*
1. Arcades and **colonnades** are permitted within the **BTZ** and shall be a minimum of 6 feet deep.
 2. The minimum interior clearance height within an arcade or **colonnade** shall be 14 feet.
- (iii) *Privacy Screen:* A privacy screen (masonry or **living fence** with opaque vegetation combined with fence or wall) 6 feet high shall be required where non-residential uses **abut** an existing single-family residential lot and shall be optional for all other adjacencies. [See also Section 9.7.4 starting on page 156 for design requirements for wall design.]
- (iv) *General Site Development Standards:* See Section 6.0 starting on page 109.

5.0 BUILDING DESIGN STANDARDS

R

5

Building Design Standards Specific to Neighborhood and Escarpment Transition Character Zones: The following standards shall be used for new development or redevelopment within the Neighborhood and Escarpment Transition Zones.

- 5.5.8. **Intent/Purpose:** Building Design Standards provide performance-based requirements intended to result in high-quality development and pedestrian-friendly environment in order to provide predictability over time and along corridors for property owners, neighbors, investors, and the public.
 - (ii) Buildings shall be designed and built with a distinct base, middle, and cap.
 - (iii) If a single-family building is set back less than 10 feet from the front property line, the grade of the slab or first floor elevation shall be elevated at least 18 inches above the grade of the sidewalk. If a single-family structure is set back 10 feet or more from the property line and is not elevated at least 18 inches above the grade of the sidewalk, a 3-foot high fence shall be provided at the front property line.

- 5.5.9. **Guidelines**
 - (i) Building entrances should be defined and articulated by architectural elements such as lintels, pediments, **pilasters**, columns, porticos, porches, overhangs, railings, balustrades, and others as appropriate. All building elements should be compatible with the architectural style, materials, colors, and details of the building as a whole. Entrances to upper level uses may be defined and integrated into the design of the overall building **façade**.
 - (ii) Buildings should generally maintain the alignment of horizontal elements along the block.

- 5.5.10. **Façade Composition**
 - (i) Buildings shall maintain a **façade articulation** rhythm of 20-30 feet along all **'A' Streets**. This **articulation** rhythm may be expressed by changing materials or color; using design elements such as fenestration, columns, and **pilasters**; or varying the setback of portions of the **façade**.

- 5.5.11. **Non-residential and Mixed-Use Building Materials**
 - (i) The following primary building materials shall be permitted for **façades** (excluding doors and windows) along any **'A' Street** or **Civic Space**:
 - a. masonry, stone, cast stone, brick, glass, glass block, split-face concrete, pre-cast concrete panels, tile, or stucco using a process other than a one-step process;
 - b. cementitious-fiber clapboard (not sheet) with at least a 50-year warranty;
 - c. wood;
 - d. architectural metal panels; and/or
 - e. other materials as approved on a case-by-case basis by the Planning Director or his/her designee.
 - (ii) **EIFS** shall not be permitted along any **'A' Street** or **Civic Space façade**.

5.0 BUILDING DESIGN STANDARDS SU-2 VHNT & VHET

- (iii) All building **façades** along all other streets or **alleys** shall be of a similar finished quality and color that blend with the front of the building. Building materials for these façades may be any of the primary materials listed above.
 - a. **EIFS** shall be limited to 25% of all other façades.
- (iv) Roofing materials visible from any public **ROW** shall be factory finished standing seam metal, slate, synthetic slate, or similar materials.
- (v) Glazing along **'A' Streets** shall not be opaque.
- (vi) To reduce mirror effect, windows shall be either glazing rated low-reflective value or a combination of glass and coating or finish to satisfy the equivalent standard. Highly reflective coatings and/or finishes are prohibited.

5.5.12. Residential Building Materials

- (i) The following shall be permitted finishes for all street-fronting **façades** (except **alleys**) of residential buildings. No more than three (3) different materials shall be used on any single façade:
 - a. cementitious-fiber clapboard (not sheet) with at least a 50-year warranty;
 - b. lap sided wood;
 - c. masonry, brick, stone, man-made stone, or stucco using a process other than a one-step process ;
 - d. architectural metal panels;
 - e. hardi plank; and/or

- f. other primary building materials approved by the Planning Director or his/her designee on a case-by-case basis.
- (ii) The following shall only be allowed up to 40% as an accent material:
 - a. **EIFS** or similar material over a cementitious base, rock, glass block, and tile.
- (iii) Side and rear **façades** shall be of finished quality and of the same color and materials that blend with the front of the building.
- (iv) Roofing materials visible from any public **ROW** shall be clay barrel tile, copper, factory finished standing seam metal, slate, synthetic slate, or similar materials.
- (v) An enclosed garage or carport shall be designed and constructed of the same material as the primary building. [See also **Section 7.7** starting on page 129.]
- (vi) Glazing along **'A' Streets** shall not be opaque.
- (vii) To reduce mirror effect, windows shall be either glazing rated low-reflective value or a combination of glass and coating or finish to satisfy the equivalent standard. Highly reflective coatings and/or finishes are prohibited.

5.0 SITE DEVELOPMENT STANDARDS



5.6. Neighborhood Transition
5.6.1. Illustrations and Intent

Note: These are provided as illustrations of intent. The illustrations and statements on this page are advisory only and do not have the power of law. Refer to the standards on the following pages for the specific Site Development Standards.

The Neighborhood Transition Zone site development standards are intended to address development between proposed Volcano Heights character zones and existing residential areas. Development standards in this zone are intended to appropriately blend the areas between new construction and existing buildings outside the Plan area.

Generally, this zone may accommodate small-scale, low-rise commercial and urban residential development. The goal is to have a reasonable buffer between existing buildings and any higher-density new construction in other character zones.

In addition, the site shall be planned in such a manner as to facilitate low-intensity, residential-scale office, and live-work buildings in a 1-2 story environment.

5.6.2. Building Design Standards Specific to Neighborhood Transition shall be as per Section 5.5.8-5.5.12 in this Plan.

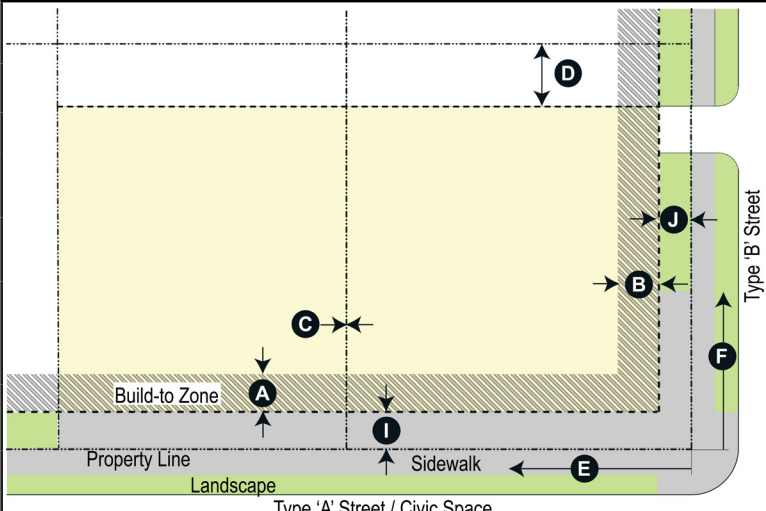
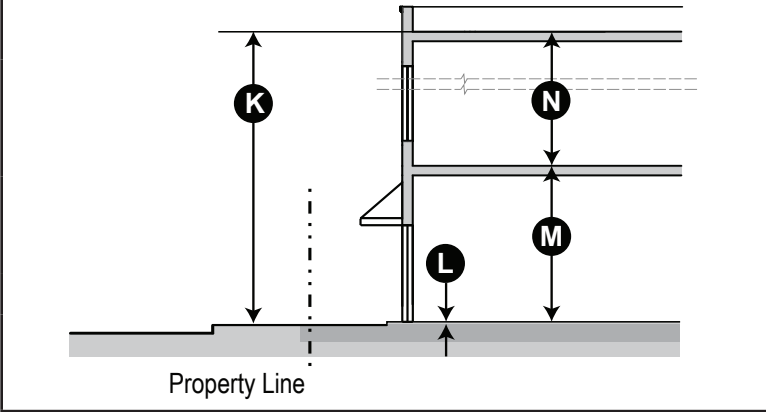
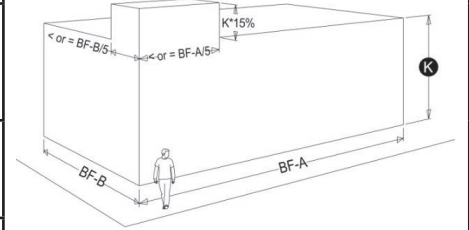

5.0 SITE DEVELOPMENT STANDARDS SU-2 VHNT

5.6.2 Building Placement	(i) Build-To Zone (BTZ) [measured from setback]	Notes
 <p>LEGEND</p> <ul style="list-style-type: none"> Property Line (dashed line) Setback Line (dotted line) Building Area (yellow) Landscape Zone (green) Build-to Zone (hatched) Sidewalk (grey) <p>* Not to scale</p>	Front (if 'A' Street and/or Civic Space) 0 – 10 feet (see #1) A	#1 – Area between the building and the edge of the BTZ at the sidewalk shall be paved flush with the public sidewalk. Where topography poses challenges, a majority of the sidewalk shall be provided at the level of the building, with appropriate approved transitions to the changed topography level.
	Front (if 'B' Street) 0 – 20 feet B	
	(ii) Setback [measured from property line]	
	Front (if 'A' Street and/or Civic Space) 5 feet (max.) I	
	Front (if 'B' Street) 10 feet (max.) J	#2 – Side and rear setbacks shall be based on minimum fire separation required between buildings, if applicable.
	Side or Rear (distance from property line) 0 feet (min.) (see #2) C D	#3 – Corner building street façades shall be built to the BTZ for a minimum of 25 feet from the corner along both streets or the width of the corner lot, whichever is less. Recessed entrances are permitted as long as the upper floors meet the BTZ standards.
	(iii) Building Frontage Required	
	% of building built to 'A' Street/Civic Space BTZ 60% (min.) (see #3 and #6) E	
	% of building built to 'B' Street BTZ 30% (min.) (see #3 and #6) F	
	5.6.4 Height Standards	5.6.3 Block Standards [for development/redevelopment > 50% of the block]
	Block Face Dimensions 200 feet (min.) 600 feet (max.)	#5 – Civic open space within the BTZ shall count toward the frontage requirement.
	Block Perimeter 2000 feet (max.)	#6 – Corner buildings may exceed the maximum building height by 15% for 20% of the building's frontage along each corresponding street façade.
	Height Standards	
	Maximum structure height 2 stories or 26 feet (max.) [See also #6 and Section 6.3] K	
First floor-to-floor height (Non-residential and Mixed Use only) 12 feet (min.) (see #4) M		
Ground Floor finish level 12 inches max. above sidewalk (for ground floor commercial-ready buildings) L		
Upper floor-to-floor height (Non-residential and Mixed Use only) 10 feet (min.) (see #4) N		

5.0 SITE DEVELOPMENT STANDARDS

<p>5.6.5 Parking and Service Access</p>	<p><i>(i) Parking Location</i></p>	<p>5.6.6 Other Standards</p>																									
<p>LEGEND</p> <ul style="list-style-type: none"> ----- Property Line ■ Surface Parking Area ■ Building Footprint ▨ Above Grade Parking Area <p>* Not to scale</p>	<table border="1"> <tr> <th colspan="2">Surface/At-grade Parking</th> <th></th> </tr> <tr> <td>'A' Street/ Civic Space setback</td> <td>Shall be located behind the principal building</td> <td>O</td> </tr> <tr> <td>'B' Street setback</td> <td>Min. of 3 feet behind building façade line along that street</td> <td>Q</td> </tr> <tr> <td>Side and Rear setback (distance from property line)</td> <td>0 feet (min.) (see Note # 2)</td> <td>P R</td> </tr> <tr> <th colspan="2">Above-grade Parking</th> <th></th> </tr> <tr> <td>Setback along 'A' & 'B' Streets or Civic Space</td> <td>May be built up to the building façade line along that street</td> <td>O*</td> </tr> <tr> <td>Side and Rear setbacks (distance from property line)</td> <td>0 feet (min.) (see Note # 2)</td> <td>P</td> </tr> </table> <p><i>(ii) Required Off-Street Parking Spaces</i></p> <table border="1"> <tr> <td>Non-residential uses within 250 feet of single-family residential</td> <td>1 space per every 300 gross square feet</td> </tr> <tr> <td>Residential Uses</td> <td>1 space/unit minimum</td> </tr> </table>	Surface/At-grade Parking			'A' Street/ Civic Space setback	Shall be located behind the principal building	O	'B' Street setback	Min. of 3 feet behind building façade line along that street	Q	Side and Rear setback (distance from property line)	0 feet (min.) (see Note # 2)	P R	Above-grade Parking			Setback along 'A' & 'B' Streets or Civic Space	May be built up to the building façade line along that street	O*	Side and Rear setbacks (distance from property line)	0 feet (min.) (see Note # 2)	P	Non-residential uses within 250 feet of single-family residential	1 space per every 300 gross square feet	Residential Uses	1 space/unit minimum	<p><i>(i) Encroachments</i></p> <ol style="list-style-type: none"> Canopies, signs, shade structures and balconies may encroach over the sidewalk as long as the vertical clearance is a minimum of 8 feet. In no case shall an encroachment be located over an on-street parking or travel lane. [See also Section 11.2.8 starting on page 207.] Building projections on all other façades may not be closer than 5 feet to any abutting property line. <p><i>(ii) Arcades and Colonnades</i></p> <ol style="list-style-type: none"> Arcades and colonnades are permitted within the build-to zone and shall be a minimum of 6 feet in depth. The minimum interior clearance height within an arcade or colonnade shall be 14 feet. <p><i>(iii) Privacy Screen:</i> A privacy screen (masonry or living fence with opaque vegetation combined with fence or wall) 6 feet high shall be required where non-residential uses abut an existing single-family residential lot and shall be optional for all other adjacencies. [See also Section 9.7.4 starting on page 156 for requirements for wall design.]</p>
Surface/At-grade Parking																											
'A' Street/ Civic Space setback	Shall be located behind the principal building	O																									
'B' Street setback	Min. of 3 feet behind building façade line along that street	Q																									
Side and Rear setback (distance from property line)	0 feet (min.) (see Note # 2)	P R																									
Above-grade Parking																											
Setback along 'A' & 'B' Streets or Civic Space	May be built up to the building façade line along that street	O*																									
Side and Rear setbacks (distance from property line)	0 feet (min.) (see Note # 2)	P																									
Non-residential uses within 250 feet of single-family residential	1 space per every 300 gross square feet																										
Residential Uses	1 space/unit minimum																										
<p>5.6.7 Façade Elements</p>	<p><i>(iii) Driveways and Service Access</i></p>	<p><i>(iv) General Site Development Standards:</i> See Section 6.0 starting on page 109.</p>																									
<p><i>(i) Doors and Windows:</i></p> <ol style="list-style-type: none"> There shall be no blank walls greater than 30 feet in width of any building along 'A' Streets and Civic Spaces. For 'B' Streets there is no requirement. Doors and windows on ground floor of all buildings shall be a minimum of 25% of the ground floor façade area along all 'A' Streets and Civic Spaces. Along 'B' Streets there is no requirement. Windows on upper floor façades along all 'A' Streets and Civic Spaces shall be a minimum of 20% of each upper floor façade area, which is measured between 3 feet and 9 feet above each finished floor. Primary entrance doors for all buildings shall be on 'A' Streets or Civic Spaces. 	<table border="1"> <tr> <td>Parking driveway width</td> <td>City DPM standards on Arterial Roadways and 25 feet max. on all other streets</td> <td>S</td> </tr> </table> <ul style="list-style-type: none"> Driveways and off-street loading and unloading shall not be located on 'A' Streets or Civic Spaces. [See also Section 6.8.3 starting on page 123.] Porte cocheres may be permitted on 'A' Streets to provide drop-off and valet service. Shared driveways and cross access easements are encouraged between lots to minimize curb cuts. If driveway and/or off-street service loading and unloading access is provided from an 'A' Street, such access is to be deemed as temporary, and cross access easements along the rear of the property may be required when adjoining properties are undeveloped. 	Parking driveway width	City DPM standards on Arterial Roadways and 25 feet max. on all other streets	S																							
Parking driveway width	City DPM standards on Arterial Roadways and 25 feet max. on all other streets	S																									



6.0 SITE DEVELOPMENT STANDARDS GENERAL TO ALL ZONES

6.0 SITE DEVELOPMENT STANDARDS GENERAL TO ALL ZONES

R

6

6.1. Gated Communities: In order to meet the intent of a walkable, urban environment that serves as a Major Activity Center, gated and/or walled developments are prohibited.

6.2. Neighborhood Design: Where new residential development is adjacent to a Connector street, new lots and homes shall face Connector streets, except where the Planning Director or his/her designee approves exceptions related to technical reasons, such as grading and drainage requirements.

6.3. Structure Heights

6.3.1. Structures within the Impact Area as designated by the Rank 3 Northwest Mesa Escarpment Plan shall be limited to 15 feet. Per the Northwest Mesa Escarpment Plan, no **exceptions** or variances shall be granted.

6.3.2. Structures within 200 feet of either the Rank 3 Northwest Mesa Escarpment Plan Impact Area or a Park Edge Street shall be limited to 18 feet, with a second story up to 26 feet permitted for no more than 50% of the building footprint. [See **Exhibit 6.1.**]

6.3.3. In Town Center only, if a developer can show documentation that a **major employer** (i.e. 150+ employees on-site) will be part of the project, that project is exempt from building height maximums and bonus height criteria, subject to a Development Agreement with the City, including clawback provisions in the case the employer leaves the Plan area before 5 years have passed. This provision is subject to approval by the City Economic Development Department.

6.3.4. In all but the Transition Zones, projects within a SAD, TIDD, PID or similar coordinated development effort that plans and engineers significant infrastructure involving multiple property owners as acceptable to the Planning Director or his/her designee may be granted a 10-foot building height bonus to the maximum heights allowed by right in each zone and above and beyond the bonus heights described in **Table 6.1** and **Section 6.4.**

6.3.5. Structure height shall be measured from approved grade to the eave line in the case of a pitched roof or to the roof line in the case of a **parapet**. [See **Section 6.5** for grading standards.]

6.3.6. A **stepback** may occur at a minimum height of 26 feet, but no building shall be built taller than 40 feet without a **stepback**. The minimum depth of a **stepback** shall be 12 feet.

6.3.7. Cupolas may extend 10 feet beyond height limits. Flagpoles may extend 6 feet above the height limit. Solar panels shall not count toward height limits. Equipment on the roof other than solar panels visible from the public **ROW** shall be screened by louvered or metal screen, or by a **parapet** for flat roofs. Screened equipment shall not exceed 6 feet beyond height limits. Screened equipment on the roof shall be set back 15 feet from **façades**. Equipment screening shall not be made of chain link or vinyl materials.

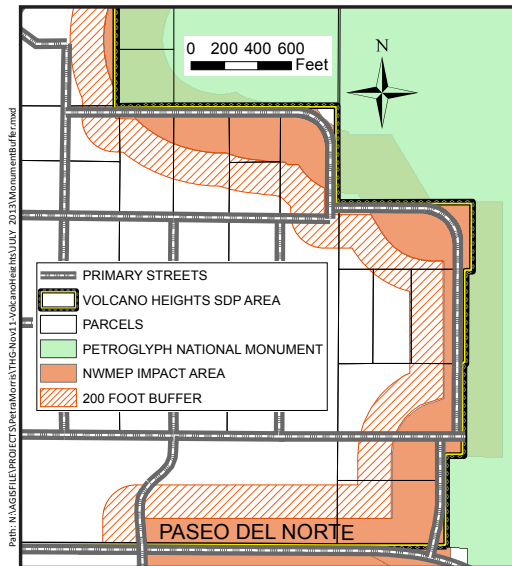

EXHIBIT 6.1 – IMPACT AREA AND 200-FOOT BUFFER

6.0 SITE DEVELOPMENT STANDARDS GENERAL TO ALL ZONES



6.4. Optional Height Bonus for Buildings

6.4.1. **Purpose / Intent:** This Plan offers an optional bonus height system for buildings in order to balance the intent to create an urban, walkable Major Activity Center with the intent to respect and honor the unique cultural, historical, geological, and volcanological area. In order to go beyond height maximums in the Center and Mixed-Use Zones (which correspond to maximum heights in the City’s NWMEP), development projects shall provide commensurate benefits to both the Natural and Built Environments.

6.4.2. **Structure height** maximums are set by Site Development Standards for each zone. Projects within all non-Transition Zones are eligible to opt in to a voluntary bonus building height system per **Table 6.1** and **Table 6.2**, with associated criteria in **Table 6.3**.

6.4.3. In order to earn a building height bonus in non-Transition Zones, projects shall incorporate required criteria to earn points for both the Built Environment and Natural Environment, per **Table 6.1**, **Table 6.2**, and **Table 6.3**.

(i) These points have been assigned values relative to the priorities and goals that meet the intent of this Plan for a high-quality built environment balanced with respect for a unique natural environment that enhances property value and adds to the quality of life for existing and future residents, employers, and employees. Point values are weighted toward their contribution to either the built or natural environment. Point values also reflect an assumed difference in cost and ease of implementation.

(ii) The total points required for each zone are calibrated based on the desired balance of urban character versus open space amenities in each zone, as well as a relative balance among all zones within the Plan area.

6.4.4. A project may shift up to 10 points between the Natural and Built Environment totals in order to better meet the intent of this Plan and/or accommodate site context.

6.4.5. The Planning Director or his/her designee shall certify and approve projects that meet the criteria for height bonuses in **Table 6.3**. The Volcano Heights Review Team may be consulted to assess whether individual standards have been met to satisfy the bonus criteria. [See **Section 3.2.6** starting on page 28.]

6.4.6. Projects that incorporate a bonus shall be required to provide a Site Development Plan for Building Permit or Site Development Plan for Subdivision that documents bonus criteria.

6.4.7. This requirement does not affect the eligibility of Site Development Plans for administrative **approval** by the Planning Director.

6.4.8. Projects incorporating bonus heights are subject to code enforcement to ensure ongoing provision of bonus criteria in the future, including maintenance of private amenities accessible by the public and preservation of natural vegetation in perpetuity.

6.0 SITE DEVELOPMENT STANDARDS GENERAL TO ALL ZONES

R

6.4.9. Private property owners may pay for or construct improvements to City-owned open space that meet bonus requirements and transfer this bonus to the property they own. Such improvements shall be coordinated with and acceptable to the City Open Space Division and meet all City standards as well as relevant requirements in this Plan.

TABLE 6.1 – TOTAL POINTS FOR BUILDING HEIGHT BONUS BY CHARACTER ZONE*

BUILDING HEIGHT BONUS CRITERIA	HEIGHT BONUS			
	VHTC	VHRC	VHVC	VHMX
Maximum Structure Height Allowed by Zone	40 ft.	40 ft.	40 ft.	26 ft.
Maximum Building Height with Bonus	75 ft.	60 ft.	60 ft.	40 ft.
I. Natural Environment Bonus Criteria	50 pts.	35 pts.	25 pts.	50 pts.
II. Built Environment Bonus Criteria	50 pts.	40 pts.	25 pts.	50 pts.
Total Points Required to Receive Height Bonus	100 pts.	75 pts.	50 pts.	100 pts.

* See also Section 6.4.4.

6

6.0 SITE DEVELOPMENT STANDARDS GENERAL TO ALL ZONES

R

6

TABLE 6.2 – BONUS HEIGHT POINTS PER CRITERION

CRITERIA FOR OPTIONAL HEIGHT BONUSES	POINTS
I. Natural Environment Bonus Criteria	
a. Rock outcropping dedications	25
b. Rock outcropping private preservation*	20
Public Access Easement (<i>Optional Bonus</i>)	5
c. Open space dedications	20
For dedications abutting rock outcroppings or other features deemed significant by the City Open Space Division (<i>Optional Bonus</i>)	5
d. Private park construction	20
e. Public park land dedication of at least 2 acres	15
f. Pedestrian walkway connection to rock outcropping, parks, trails, rock outcroppings, or other features deemed significant by the City Open Space Division	10
Up to 2 additional connections to features deemed significant by the City Open Space Division (<i>Optional Bonus</i>)	5 each
g. Landscaping / natural buffers in addition to what's required by Zone	10
h. Shared drainage/swales on adjacent developments / Low Impact Design (LID)	10
i. View preservation	10
j. Community garden	10
k. Interpretive signage	5
l. Preservation of native vegetation	5
m. Other benefits to the natural environment	5
II. Built Environment Bonus Criteria	

CRITERIA FOR OPTIONAL HEIGHT BONUSES	POINTS
a. Publicly accessible plazas / courtyards in addition to what's required by Section 9.5.4 starting on page 144.	25
b. Living roof or accessible roof garden	25
c. Grey water retention system	25
d. Transit shelters on transit corridors	20
e. LEED certification	20
f. Transit Center within 500 feet of proposed project	15
g. Public art	15
h. Solar panels	15
i. Permeable paving	10
j. Permanent streetscape/plaza furniture and/or features	10
k. Gateway feature at key intersections	10
l. Rooftop water harvesting / cisterns	5
m. Other sustainable building practices	5

* See also **Policy 13.1.3** starting on page 224 and **Appendix D**.

6.0 SITE DEVELOPMENT STANDARDS GENERAL TO ALL ZONES

TABLE 6.3 – STANDARDS FOR OPTIONAL HEIGHT BONUS CRITERIA

R

6

I. Natural Environment Bonus Criteria	
a.	Dedicating a rock outcropping shown in Exhibit 9.1 plus a buffer acceptable to City Open Space Division shall meet the criteria for these points. The land shall be dedicated to the City following the process outlined in City Zoning Code §14-16-3-8(A) or by plat, deed, or other legal instrument acceptable to City Real Property.
b.	Private preservation may be accomplished through Transfer of Development Rights (TDR), conservation easement, or platting as private open space . The additional 5 points for public access may be accomplished through granting a public access easement that stays in place in the event of transfer of property ownership.
c.	Open space dedications, either on-site or offsite, shall be a minimum of one-half acre and acceptable to the City Open Space Division. Points may be granted at a rate of 5 points per acre up to a total of 20 points.
d.	A private park shall be one-half acre or larger and maintained by the property owner or property owner association. A public access easement shall be granted and filed with the City. In order to gain the bonus points, a park shall include shade trees in addition to two (2) or more of the following features: playground or equivalent recreational amenity, shade structure, seating area or tables, a sculpture or other artwork. These points may be granted per the discretion of the Planning director or his/her designee.
e.	Land dedicated for City-owned public parks shall be 2 acres or larger and must meet the approval and standards of the City Parks and Recreation Department.
f.	Pedestrian walkways constructed according to criteria in Table 9.4 (xv) shall meet the criteria for these points. Pedestrian walkways that provide connections to rock outcroppings or other features deemed significant by City Open Space Division, including those features mapped in Exhibit 9.1 , shall be eligible for an additional 5 bonus points per feature connected.
g.	Landscaped area at least 25% in excess of the requirement shall meet the criteria for these points.
h.	Shared swales shall be designed for the secondary purpose of additional open space OR to water living material in the landscaping on the site or streetscaping. They shall be privately constructed and maintained.
i.	Developments that can graphically demonstrate an arrangement of roadways, building placement, and/or building setback to preserve views toward the Sandia Mountains, volcanoes, or City vistas across the Rio Grande shall meet the criteria for these points.
j.	See Table 9.4 (iv) .
k.	Projects that include at least 2 educational, cultural, and/or historical signs or markers pertaining to Volcano Heights that are accessible to pedestrians and cyclists and follow Policy 3.106 in the Volcano Mesa amendment to the West Side Strategic Plan shall meet the criteria for these points. Signs shall be a minimum of 18 by 18 inches and a maximum of 24 by 36 inches.
l.	Projects that preserve native vegetation, especially juniper trees, are eligible for 5 bonus points per 100 square feet up to 50 total points. Native vegetation in usable and/or detached open space on-site may be counted toward this bonus. Applicants shall provide a site plan, photographs, and other relevant documentation of original site conditions.
m.	Applicants may demonstrate other benefits to the natural environment. These points may be granted per the discretion of the Planning director or his/her designee.

6.0 SITE DEVELOPMENT STANDARDS GENERAL TO ALL ZONES

TABLE 6.3 – STANDARDS FOR OPTIONAL HEIGHT BONUS (Cont'd)

II. Built Environment Bonus Criteria	
a.	Plazas or courtyards at least 25% in excess of the requirement per General Standard 9.5.4 starting on page 144 AND incorporating at least two (2) of the following features: shade structure, seating area or tables, water features with low-water use and/or recycled water, a sculpture or other artwork. These points may be granted per the discretion of the Planning director or his/her designee. A public access easement that stays in place in the event of transfer of property ownership shall be granted and filed with the City.
b.	Improving rainwater quality by removing sediment and floatables.
c.	Incorporation of a retention system on-site that stores greywater for re-use for irrigation and/or building systems. These points may be granted per the discretion of the Planning director or his/her designee (e.g. the City hydrologist).
d.	Transit shelters shall be built per City ABQ RIDE standards and in coordination with ABQ RIDE staff and dedicated to the City. Transit shelters built within the public ROW may be counted as usable or detached open space . Paved areas such as stop pad shall also count as landscaped area.
e.	LEED certification or equivalent for buildings or for Neighborhood Design are both eligible for points toward the Height Bonus. Individual elements matching other criteria in this Table shall also be eligible for points toward the Height Bonus.
f.	Sites located within 500 feet of a developed or permitted City of Albuquerque Transit Center.
g.	One percent (1%) of project budget devoted to installation and maintenance of public art in plazas and/or outdoor spaces or incorporated into the architecture of buildings on private property or in public spaces, to be commissioned by a New Mexico artist registered with City Department of Cultural Services and managed in any combination of the following methods: <ul style="list-style-type: none"> • Property owner or designee to pick the artist and install and maintain the art, in which case 10% of the 1% shall be allocated to City Department of Cultural Services and earmarked for 5 years to be used in the event that the property owner ceases to maintain the art. After 5 years, these funds revert to the general Department budget. • Property owner or designee to allocate funds to City Department of Cultural Services, in which case 90% of the 1% pays for initial art installation on the property, and 10% is kept in reserve for ongoing maintenance by the City. • Property owner or designee to allocate funds to City Department of Cultural Services for installation of art anywhere in the Plan area, in which case 90% of the 1% pays for initial art installation, and 10% is kept in reserve for ongoing maintenance by the City.
h.	Photovoltaic or other equivalent technology that is designed and installed to generate at least 40% of the project's power needs. Solar panels must have at least one layer of anti-reflective coating to minimize glare. Exposed frames and components shall have a non-reflective surface.
i.	At least 50% of the project's surface parking areas shall be paved with a surface of equal or superior performance characteristics to asphalt but allowing permeability of runoff, such as compacted, stabilized crusher fines.
j.	Permanent furniture/features includes interactive public amenities such as but not limited to lifesize gameboards, tables & seating, low water-use fountains, amphitheaters, labyrinths, shade structures, transit shelters, etc. These elements shall not be included in sidewalks less than 12 feet wide and shall in no case result in less than 6 feet clearance for ADA accessibility.
k.	Per criteria in Section 9.7.6 starting on page 157.
l.	Incorporation of systems that store rainwater for future on-site uses such as irrigation.
m.	These points may be granted per the discretion of the Planning director or his/her designee.

R

6

6.0 SITE DEVELOPMENT STANDARDS GENERAL TO ALL ZONES

R

6

6.5. Grading

- 6.5.1. **Purpose / Intent:** This Plan restricts grading in order to protect natural topography and distinct topographic and natural character to the extent possible. Natural terrain and geological features make the area unique, desirable, and of value to residents and the larger community.
- 6.5.2. Cut and fill slopes shall be no steeper than 3:1 on average, and retaining walls shall not exceed 4 feet in height unless incorporated within a building's foundation or approved by the City Hydrologist as necessary for development.
- 6.5.3. Graded areas shall maintain the character of the natural terrain by varying gradients, undulating contours, and rounding the toe and crest of any slope greater than 10 feet in height.
- 6.5.4. Fill shall be limited to four (4) feet except as deemed necessary for site development and drainage by the City Hydrologist. When more than 4 feet of fill is proposed, a project shall require **DRB approval** in order to ensure coordination with the City Hydrologist, City Open Space Division, and other relevant City staff.
- 6.5.5. Fill shall not exceed the existing highest natural grade point on site, unless approved by the City Hydrologist for required drainage. Fill height shall be measured from the natural grade.

6.5.6. In the selection of alignment and in site design, grading plans shall demonstrate that cut and fill has been kept to a minimum consistent with the standards in this Plan. Generally, the overall topography of the site is not to be substantially altered.

- 6.5.7. Due to the area's proximity to the Petroglyph National Monument and the importance of protecting petroglyphs from fugitive dust that may occur during site development and construction, development shall comply with the following standards:
- (i) All development $\frac{3}{4}$ acres or over must comply with the Albuquerque-Bernalillo County Air Quality Control Board Fugitive Dust Control Regulation found in the New Mexico Administrative Code 20.11.20.
 - (ii) All development must comply with the City Drainage Control Ordinance and the Flood Hazard Control Ordinance, including a requirement for an approved Erosion and Sediment Control Plan prior to being issued a grading permit.

[Amended
November 5,
2014]

6.0 SITE DEVELOPMENT STANDARDS GENERAL TO ALL ZONES

[Amended
November 5,
2014]

- (iii) For all non-residential and mixed-use developments, grading permits shall only be issued concurrently with building permits.
- (iv) For exclusively residential developments, a grading permit shall only be issued after a preliminary plat and an Erosion and Sediment Control Plan have been approved.
- (v) Exceptions for grading in advance of a building permit or approved preliminary plat may be allowed under the following conditions:
 - a. Requirements enumerated in items (i) and (ii) above are met.
 - b. While active grading is underway there must be water truck/s onsite and actively performing wet suppression activities.
 - c. Once grading is complete, but prior to building permit or preliminary plat approval, the site must be stabilized using one of these four methods:
 - 1. A sprinkler system providing daily wet suppression must be onsite and shown to be functional.
 - 2. 2" of gravel mulch must be applied over all disturbed areas/ stock piles.
 - 3. vegetative cover consistent with the COA Specifications Section 1012 including the crimping-in of straw mulch after seed application.
 - 4. The application of spray-on adhesives, with reapplication per the manufacturer's

recommendations. This method is only allowed if the site is adequately fenced to prevent ATV vehicles from disturbing the treated soils.

- d. The proposed method of stabilization must be approved by the City Engineer or his/her designee prior to any grading activity on the site. A site that has had grading activity prior to building permit/preliminary plat is not eligible for approval of such without an approved soil stabilization method in place.
- (vi) Grading within public rights-of-way or public easements requires a fugitive dust permit and grading permit per (i) and (ii) above.

R

6

6.0 SITE DEVELOPMENT STANDARDS GENERAL TO ALL ZONES

R

6.6. Construction Mitigation

6.6.1. **Purpose / Intent:** Any damage to the vegetation, slope, or placement of boulders due to or related to construction shall be mitigated as provided herein.

[Amended
November 5, 2014]

6.6.2. Prior to beginning any construction, the property owner, developer, or infrastructure contractor (whichever is the most relevant) shall complete the following requirements.

- (i) A temporary silt fence shall be constructed at the site boundary adjacent to sensitive lands (i.e. the Escarpment buffer, Major Public Open Space, archeological site, or public or private conservation area to be maintained in natural desert-scape) to effectively protect them from heavy equipment and vehicles.
 - a. Construction or silt fencing shall be placed no less than 12” from the Petroglyph National Monument boundary.

- b. The temporary silt fence shall comply with the most recently approved City Air Quality Control Division standards and requirements.
- (ii) Photographs of the project site in its original condition shall be submitted with the application for **building permit**, subdivision, and/or site development plan. Within the Escarpment Transition zone only, in lieu of photographs, a comprehensive video recording of existing conditions and situations of rocks and boulders shall be submitted to inform compliance with permitting and other approvals.
- (iii) Applications for public- and private-sector projects, especially infrastructure, within the Escarpment Transition zone or **adjacent** to archeological sites shall include geotechnical data and analysis that demonstrate to the satisfaction of the City Engineer, in coordination with the City Open Space Division and National Park Service, that proposed trenching or blasting will not affect the face of the Escarpment, whether by potentially causing erosion or caving of the slopes and boulders, threatening public safety or welfare, or otherwise damaging archeological resources.

6

6.0 SITE DEVELOPMENT STANDARDS GENERAL TO ALL ZONES



[Amended
November 5, 2014]

- a. Clear limits of construction shall be established so that construction activities do not encroach on Petroglyph National Monument. The National Park Service and/or City Open Space Division shall be permitted to monitor any construction staking within the Escarpment Transition zone. No construction easements on the Monument shall be granted.
 - b. For any construction within the Escarpment Transition zone that includes blasting, the City Open Space in coordination with the National Park Service may require monitors to be placed between the blast site and the Petroglyph National Monument boundary in order to record blast data to ensure that disturbance remains within approved levels. Monitor data may be required to be maintained for up to one year following final completion of the project.
- 6.6.3. Replacement of boulders shall approximate the original location, angle, and surface exposure, based on pre-construction photographs and/or comprehensive video recording.
- 6.6.4. Vegetation to approximate original cover with native or xeric plants as appropriate from the Plant List in **Table 9.5** is required within 90 days of project completion. [See **Section 9.7.3** starting on page 151 to determine whether

native or xeric species are required.] A deviation may be granted by the Planning Director or his/her designee if the type of vegetation or time of year make revegetation within 90 days impossible or undesirable. For infrastructure projects on public lands, the construction company shall post a warranty bond effective for three years after completion of the infrastructure work to ensure successful revegetation.

- 6.6.5. To minimize the negative impact of fugitive dust on petroglyphs, no stockpiling of rock or basalt or rock crushing shall be permitted within 1320 feet (1/4 mile) of the Petroglyph National Monument boundary.
- 6.6.6. Significant archaeological sites shall be protected as appropriate to respect the area's unique cultural history.
- (i) For purposes of this section, archaeological resource and archaeological site shall be defined as set forth in the City Zoning Code §14-16-3-20 (i.e., the Albuquerque Archaeological Ordinance).
 - (ii) In addition to the applicability set out in the City Zoning Code §14-16-3-20, the Archaeological Ordinance shall apply when an applicant initiates the approval process for any of the following:
 - a. A site development plan or master development plan for a project that is 2 or more acres in size on property that is zoned SU-1 Special Use or an SU-2 zone that requires site plan review; or

[Amended
November 5, 2014]

6.0 SITE DEVELOPMENT STANDARDS GENERAL TO ALL ZONES

R

6

[Amended
November 5, 2014]

- b. An archaeological resource is discovered that the City Archaeologist deems significant. In the event that a potential archaeological resource is discovered during development or land disturbance activity, the property owner shall temporarily cease all development activities and shall contact the City Archaeologist to determine whether the discovery has significant research or other value. If the site is determined to be significant, the property owner shall submit a preservation plan or data recovery and documentation plan for those resources that the City Archaeologist has determined to have significant research or other value per the requirements in the City Zoning Code §14-16-3-20. Upon approval of the plan by the City Archaeologist, the property owner may proceed with development.
- (iii) No petroglyph shall be defaced, altered, or moved without approval of the City Archaeologist or other appropriate City staff in consultation with a National Park Service representative from the Petroglyph National Monument. To the extent possible, rock outcroppings containing petroglyphs should be protected per City Zoning Code §14-16-3-20.
- (iv) All other significant archaeological sites shall be protected or mitigated per City Zoning Code §14-16-3-20. Site treatment shall consider preservation, avoidance, testing, and/or documentation of surface and/or subsurface remains and/or artifacts. Any buffers or setbacks included as part of the treatment plan may be counted as usable open space.

6.0 SITE DEVELOPMENT STANDARDS GENERAL TO ALL ZONES

6.7. Infrastructure

6.7.1. Utilities

(i) Easements

- a. In order to facilitate pedestrian movement and maintain accessibility, utility infrastructure such as poles, transformers, boxes, and access panels shall be planned for minimal visual intrusion and mobility impediment to pedestrians. Overhead and underground electric distribution lines are typically located within public utility easements (PUE) or private easements. They are compatible with other “dry” utilities such as cable, telephone, and fiber optic facilities. The width of the PUE is typically 10 feet in order to provide necessary clearances for safety.
- b. Water lines, sewer lines and storm water drainage or “wet” utilities are not compatible with “dry” utilities, and separation is required for safety purposes. Dry utility easements (electric, cable, phone, fiber optics) and wet utility easements (water, sewer) are located subject to provisions of all applicable codes including the New Mexico Electrical Safety Code for safety reasons.

- c. In all zones, utility easements shall be located in **alleys** or rear access and parking areas, if available. Where there is no alley, utility infrastructure may be placed in a PUE or private easement in the front **setback** of the property, provided it does not substantially affect the pedestrian realm and is located on the edge or side of property and as far away from the main entrance and pedestrian access paths as possible. Main service line utility infrastructure connecting with public utility easements in alleys shall be accommodated in front setbacks and/or Build-to Zones. [See also **Section 10.7.7** starting on page 204.]

- (ii) **Construction:** For any construction within the Escarpment Transition zones that includes blasting, see **Section 6.6.2** starting on page 118.

(iii) **Clearance**

- a. Any screening and vegetation surrounding ground-mounted transformers and utility pads shall allow 10 feet of clearance in front of the equipment door and 5 feet of clearance on the remaining 3 sides for access and to ensure work crew and public safety during maintenance and repair.
- b. Non-permanent use of clearance, such as for parking, is permitted. All uses shall require an encroachment agreement with PNM.

R

6

6.0 SITE DEVELOPMENT STANDARDS GENERAL TO ALL ZONES

R

- c. Aesthetic improvements, such as painting, are encouraged to minimize visual impact of ground-mounted utility equipment. PNM may have guidelines for the most appropriate types of paint and/or other materials to use. Any identifying numbers shall not be obscured. All improvements are subject to removal as necessary for repair and/or maintenance.
- d. Trees and shrubs planted in the PUE should be planted to minimize impacts on facilities maintenance and repair. They are subject to removal as necessary for repair and/or maintenance.

6

- 6.7.2. **Roads:** See **Section 10.0 Street Standards** starting on page 163.

6.0 SITE DEVELOPMENT STANDARDS GENERAL TO ALL ZONES

6.8. Street Screens

- 6.8.1. Except as noted elsewhere in this Plan, all required street screens shall be made up of (a) the same material as the principal building or (b) a combination of masonry and **living fence**. Required street screens shall be located at the setback line unless otherwise noted in this Plan. [See also **Section 9.7.4** starting on page 156 for requirements for wall design.]
- 6.8.2. Where provided, the **living fence** shall be within a minimum 3-foot wide planting strip located on the pedestrian, residential, or public street side. [See also **Section 9.7.4** starting on page 156.]
- 6.8.3. Any off-street loading, unloading, storage, service, or trash pick-up areas shall be screened using a **street screen** at least as tall as the trash containers and/or service equipment it is screening at the **BTZ**.
- 6.8.4. Parking visible from the public **ROW** along an **'A'** or **'B'** Street shall have a **street screen** of masonry and/or metal railing 3-6 feet high combined with a landscape strip at least 3 feet wide on the pedestrian, residential or public street side.
- (i) Along a **'B'** Street frontage, this requirement may be waived as a minor deviation if the applicant can show sufficient evidence of intent to build a parking structure within 2 years. [See **Table 3.2** starting on page 31.]
- (ii) If construction of a parking structure has not commenced within 2 years, a street screen shall be required.
- 6.8.5. Drive-through facilities, where allowed by zone

and located on a **'B'** Street, shall be screened from view via location behind a building on-site or a **street screen**, specifically:

- (i) **Screening:** A street screen shall be provided for drive-up service windows and associated drive-up queue lanes that abut public streets or pedestrian areas. Screening may also be provided by placing the drive-up service windows and/or queue lanes between two adjacent and parallel buildings.
- (ii) **Drive-up Service Windows:**
- a. Drive-up service windows shall not be on a façade that faces or fronts an **'A'** Street.
- b. Drive-up service windows shall be oriented away from pedestrian areas, such as sidewalks and plazas, and residentially-zoned areas, where possible.
- (iii) **Queue Lanes:** Queue lanes shall not be located parallel to **'A'** Streets, unless they are located behind a building.
- 6.8.6. Utility equipment, including electrical transformers, gas meters, etc., shall be screened with a **street screen** at least as high as the equipment being screened.
- 6.8.7. All street screening shall be designed to be compatible with utility infrastructure, particularly to address safety considerations for utility crews during maintenance and repair.
- 6.8.8. Rainwater harvesting equipment is not permitted on any **'A'** Street. On all other frontages, they shall be screened with a **street screen** at least as high as the equipment being screened.

R

6

[Amended
November 5, 2014]

6.0 SITE DEVELOPMENT STANDARDS GENERAL TO ALL ZONES

R

6

6.9. Design of Site Elements for Automobile-related Uses

- 6.9.1. Drive-through lanes for commercial uses shall not be located along **'A' Streets** or **Primary 'B' Streets**.
- 6.9.2. Gas pumps, canopies, and/or service bays shall not be located along **'A' Streets**. No more than 50% of a lot's frontage along a **'B' Street** may be occupied by gas pumps, canopies, and/or service bays.
- 6.9.3. Outdoor **storage** of vehicles or other products sold shall not be permitted along any **'A' Street**. Along **'B' Streets**, outdoor storage of vehicles or other products sold shall not exceed 50% of a lot's frontage. [See also **Section 6.8.3.**]
- 6.9.4. All off-street loading, unloading, and trash pick-up areas shall be located along **'B' Streets** or **alleys** unless permitted in the specific Site Development Standards in **Section 5** and/or **6**. [See also **Section 6.8.3.**]
- 6.9.5. See also **Section 7.8** starting on page 131 for building design requirements for auto-related uses.



7.0 BUILDING DESIGN STANDARDS GENERAL TO ALL ZONES

7.0 BUILDING DESIGN STANDARDS GENERAL TO ALL ZONES

R



7

All development plans shall comply with the standards below.

7.1. Purpose/Intent: The Building Design Standards for the Volcano Heights Sector Development Plan should establish a coherent urban character and encourage enduring and attractive development.

Three key design principles for Volcano Heights support the preservation, sustainability, and visual quality of different development **character zones**:

- Buildings should use building elements and details to achieve a **pedestrian-oriented** public realm within the Town and Village Centers and Mixed-Use and **Transition Zones**, along **'A' Streets**, and at 'A' street intersections.
- Compatibility is not meant to be achieved through uniformity, but through variations in building elements to achieve individual building identity.
- Building **façades** should include architectural details and ornamentation to create variety and interest.

The design of buildings and their relationship to **adjacent** streets should depend on the context of the development. Generally, the corridor should become more **pedestrian-oriented** farther from the Paseo del Norte/ Unser Boulevard intersection within each development quadrant, along the proposed **transit corridor**, and particularly within the Town Center. Generally, buildings should be located and designed to provide visual interest and create enjoyable, human-scaled spaces between and among buildings.

7.2. Building Orientation

7.2.1. Buildings shall be oriented toward **'A' Streets**, where the **lot** has frontage along an **'A' Street**. All other buildings shall be oriented toward **Civic Spaces**. Where a building does not front on an **'A' Street** or **Civic Space**, the building shall be oriented toward a **'B' Street**.

7.2.2. Primary entrances to buildings shall be located on the street along toward which the building is oriented or toward **civic spaces**, where applicable. At intersections, corner buildings may have their primary entrances oriented at an angle to the intersection. [See also **Section 7.8.1** starting on page 131.]

7.2.3. All primary entrances shall be oriented to the public sidewalk for ease of pedestrian access. Secondary and service entrances may be located from internal parking areas or **alleys**.

7.2.4. Garages, carports, or new surface parking for residential buildings shall be located and accessed from **'B' Streets** or **alleys** at the rear of residential buildings.

7.2.5. Service entrances shall be screened from **abutting** single-family residences as well as the public **ROW** as per **Section 6.8.3** starting on page 123 in this Plan.

7.3. Building Massing and Scale: Commercial and mixed-use buildings shall be simply massed with flat or low pitched roofs with **parapets**, projecting roofs, or both. Commercial and mixed-use buildings located on a corner have flexibility for corner treatments but must adhere to the frontage requirements in the Site Development Standards in **Sections 5** and **6**.

7.0 BUILDING DESIGN STANDARDS GENERAL TO ALL ZONES

7.4. Zero Lot Line Structures

7.4.1. Prior to being issued a building permit, a property owner wanting to build a structure with a wall on a lot line shall submit to the City a maintenance easement agreement signed by the abutting property owner, unless the building is part of an attached unit development.

[Amended November 5, 2014]

7.4.2. Where there is no **setback** from the property line, gutters and downspouts shall drain to the street or **water harvesting** area to avoid impact to **abutting lots**.

7.5. Structure Color

7.5.1. In order to minimize the visual impact of development, colors shall be restricted to light reflective values between 20 and 50 percent. Metal items such as vents, cooling units, and other mechanical devices on roofs are subject to this regulation.

- (i) This range of color general includes yellow ochres, browns, dull reds, and grey-greens, similar to the natural colors found on the mesa and escarpment. This middle range of reflectance is intended to avoid very light and very dark colors.
- (ii) Stucco, block, and/or brick shall have integral color other than the standard grey.
- (iii) Other materials with colors similar to those illustrated in **Exhibit 7.1** may be used, as long as they have integral color other than the standard grey and meet the standards for reflectivity and harmony with colors in the natural landscape. [See **Section 9.7.4** starting on page 156 for more details about restrictions for walls and fences.]

APPROPRIATE COLORS FROM THE NATURAL LANDSCAPE



LIGHT REFLECTANCE VALUES

Chart Color	LRV %	Chart Color	LRV %
122 Straw	41.83	135 Sahara	34.63
106 Buckskin	34.73	116 Adobe	24.03
118 Suede	37.67	124 Coral	34.93
117 Fawn	45.48	115 Cottonwood	32.18

LRV data is from El Rey Stucco; El Rey does not guarantee the LRV data provided. Colors are illustrative from El Rey Standard Color for Premium Stucco Finish. Color reproduction in this Plan is not an exact representation of the El Rey color chart.

EXHIBIT 7.1 – SAMPLE COLORS

NOTE: These sample colors are stucco with integrated color as manufactured by El Rey traditional cementitious stucco in Albuquerque. This compound includes cement, hydrated lime, sand aggregates, and iron oxide pigments. Since the stucco is integrally colored, it will never need to be painted. Like many natural landscapes, the traditional cement stucco is breathable and appears slightly different during each season and at alternate times of the day.

EXHIBIT 7.1 – SAMPLE COLORS

7.0 BUILDING DESIGN STANDARDS GENERAL TO ALL ZONES

R



7.5.2. In keeping with New Mexico tradition, accent colors on front doors, window sashes, trim, and other incidental elements up to 20% of a façade are allowed. The intent is to avoid overwhelming the building's basic color or creating a visual distraction from the adjacent streets, lots, public areas, or most importantly, open space, whether private or public.

7.6. Design of Parking Structures

7.6.1. All frontages of parking structures located on **'A' Streets** or **Civic Spaces** shall not have parking uses on the ground floor to a minimum depth of 30 feet along the street frontage.

7.6.2. The amount of street frontage devoted to a parking structure shall be minimized by placing the shortest dimension along a street edge or by lining the ground floor with retail or other uses.

7.6.3. Parking structure **façades** on all **'A' Streets** or **Civic Spaces** shall be designed with both vertical (façade rhythm of 20 feet to 30 feet) and horizontal (aligning with horizontal elements along the block) **articulation**.

7.6.4. Where above-ground structured parking is located at the perimeter of a building with frontage along an **'A' Street** or **Civic Space**, it shall be screened in such a way that cars on all parking levels are completely screened from view from all **adjacent** public streets. Parking garage ramps shall not be visible from any public street. Ideally, ramps should not be located along the perimeter of the parking structure. Architectural screens shall be used to articulate the **façade**, hide parked vehicles, and shield lighting.

7.6.5. When parking structures are located at corners, corner architectural elements shall be incorporated such as corner entrances, signage, and glazing.

7.6.6. Parking structures and **abutting** sidewalks shall be designed so pedestrians are clearly visible to entering and exiting automobiles and, in turn, can see the automobiles.

7



7.0 BUILDING DESIGN STANDARDS GENERAL TO ALL ZONES



7.7. Design of Residential Garages

- 7.7.1. See “Other Uses” items **OU-6** and **OU-7** in the **Table 4.4** starting on page 64 to determine whether garages are permitted in the relevant character zone. The following standards apply where residential garages are permitted by right or conditionally.
- 7.7.2. Where alleys are available, residential garages shall be accessed via the alley.
- 7.7.3. Townhouses and courtyard apartments shall use rear-loaded garages.
- 7.7.4. Front-loaded garages on residential lots less than 40 feet wide shall be prohibited. Garages on these lots shall be either Garage Type A or D in **Exhibit 7.2** per the standards in **Table 7.1**.
- 7.7.5. Lots equal to or greater than 40 feet shall use any of the garage types in **Exhibit 7.2** per the requirements in **Table 7.1**.
- 7.7.6. Driveway access from a ‘B’ Street, including drive pad but exclusive of wings, is limited to 14 feet for Garage Types B, C, D, E, and F except where providing access from alleys.

[Amended November 5, 2014]

- 7.7.7. Where front-loaded garages are allowed, garage doors shall not exceed 50% of the total front façade area, inclusive of porches, when viewed from the street, so that garage doors do not dominate the front façade. Except for Garage Type D, garages must be set back from the main façade.
- 7.7.8. Front-loaded three-car garages are not permitted on **lots** equal to or less than 55 feet wide. Three-car garages on lots greater than 55 feet wide shall have a third garage setback of two (2) feet minimum from the primary garage **façade**.
- 7.7.9. The color of garage doors shall blend with or complement the exterior wall color in order to minimize the prominence of the garage door.

TABLE 7.1 – RESIDENTIAL GARAGE TYPES*

LOT WIDTH	ALLOWABLE GARAGE TYPES*	FRONT GARAGE SETBACK FROM MAIN FAÇADE (Front-loaded)	SIDE GARAGE SETBACK FROM PROPERTY LINE (Side-accessed)	REAR GARAGE SETBACK FROM PROPERTY LINE (Rear-loaded)
40+ Feet	A, B, C, D, E, F	10 ft. Minimum	5 ft. Minimum	2 ft. Minimum
Less than 40 Feet	A, D	10 ft. Minimum	5 ft. Minimum	2 ft. Minimum

Note 1: Garage Type D shall have a minimum of 5 linear feet of fenestration on the street façade and be articulated to resemble the main structure.

Note 2: Garage Types D and F may be accessed from either front or side.

* See **Exhibit 7.2** – Residential Garage Type Diagrams

7.0 BUILDING DESIGN STANDARDS GENERAL TO ALL ZONES

R

7

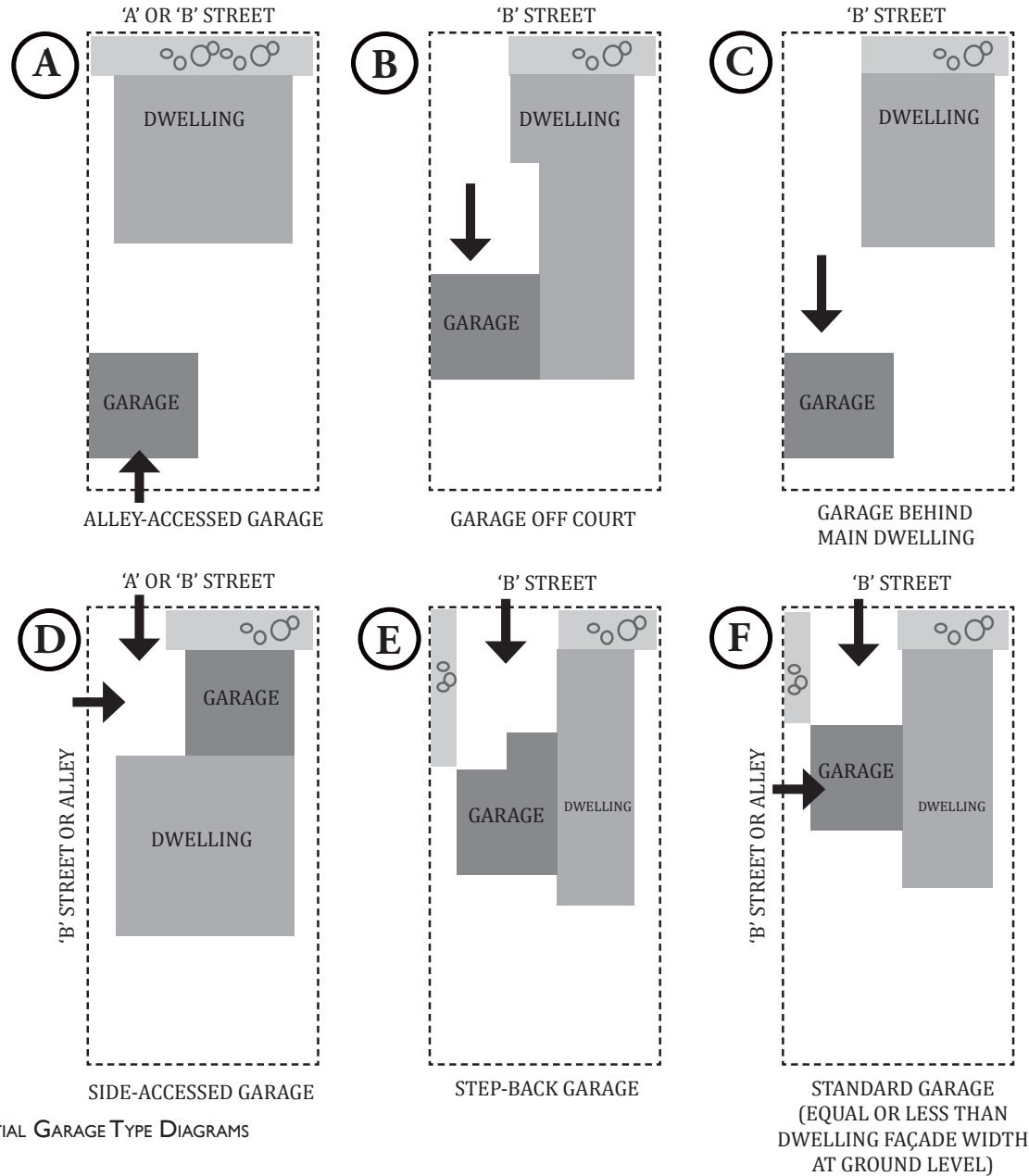

EXHIBIT 7.2 – RESIDENTIAL GARAGE TYPE DIAGRAMS

[Amended
November 5, 2014]

7.0 BUILDING DESIGN STANDARDS GENERAL TO ALL ZONES

7.8. Design of Automobile-related Buildings

- 7.8.1. Any buildings associated with any automobile-related use shall also have a pedestrian entrance on an **'A' Street**.
- 7.8.2. See also **Section 6.8. Street Screens** starting on page 123.
- 7.8.3. See also **Section 6.9. Design of Site Elements for Automobile-related Uses** starting on page 124.

7.9. Wireless Telecommunications Facilities (WTFs)

- 7.9.1. Wireless telecommunications antennas shall be permitted, pursuant to City Zone Code §14-16-3-17, on rooftops and shall be architecturally integrated and/or screened entirely with a screen the same color as the principal building on which it is mounted. Antennas shall not be visible from any adjacent **'A' street**.
- 7.9.2. Concealed, free-standing WTFs are not permitted. Free-standing, array WTFs are not permitted, consistent with City Zoning Code §14-16-3-17, the Wireless Telecommunications Regulations.
- 7.9.3. Co-location on existing structures, including but not limited to public utility structures, is encouraged.

R

7

This Page Left Intentionally Blank



8.0 SIGN STANDARDS

8.0 SIGN STANDARDS

R

8

8.1. Applicability

- 8.1.1. Except as specifically listed below, all other signage and sign standards shall comply with City Zoning Code §14-16-3-5, as amended.
- 8.1.2. Signs along Unser Boulevard must also comply with the Design Overlay Zone (DOZ) for that roadway adopted in 1992. [See **Exhibit 8.1** on page 135.] Where conflicting, the most restrictive regulation prevails, except that sandwich board signs and blade signs (including both building and tenant signs) are permitted within Volcano Heights per the regulations in **Table 8.1**.
- 8.1.3. Where the Zoning Code, Unser DOZ, or Plan is silent, relevant regulations in the other locations prevail.
- 8.1.4. For new signs, the standards in **Table 8.1** shall apply, and sign permits may be approved administratively unless specifically noted in this section.
- 8.1.5. Properties are allowed as many sign types as permitted by zone.
- 8.1.6. Definitions and examples of each sign type are included in **Section 3.5** of this Plan.

8.2. Unique Sign Applications: An **applicant** has the option to establish unique sign standards including size, color, type, design, and location. Such applications shall be reviewed as “Unique Sign Plans” by the Planning Director or his/her designee and are subject to **approval** of the **DRB**. In evaluating a Unique Sign Plan, the **DRB** shall consider the extent to which the application meets the following:

- 8.2.1. Promotes consistency among signs within a development thus creating visual harmony among signs, buildings, and other components of the property;
- 8.2.2. Enhances the compatibility of signs with the architectural and site design features within a development;
- 8.2.3. Encourages signage that is in character with planned and existing uses, thus creating a unique sense of place; and/or
- 8.2.4. Encourages multi-tenant commercial uses to develop a unique set of sign regulations in conjunction with development standards.

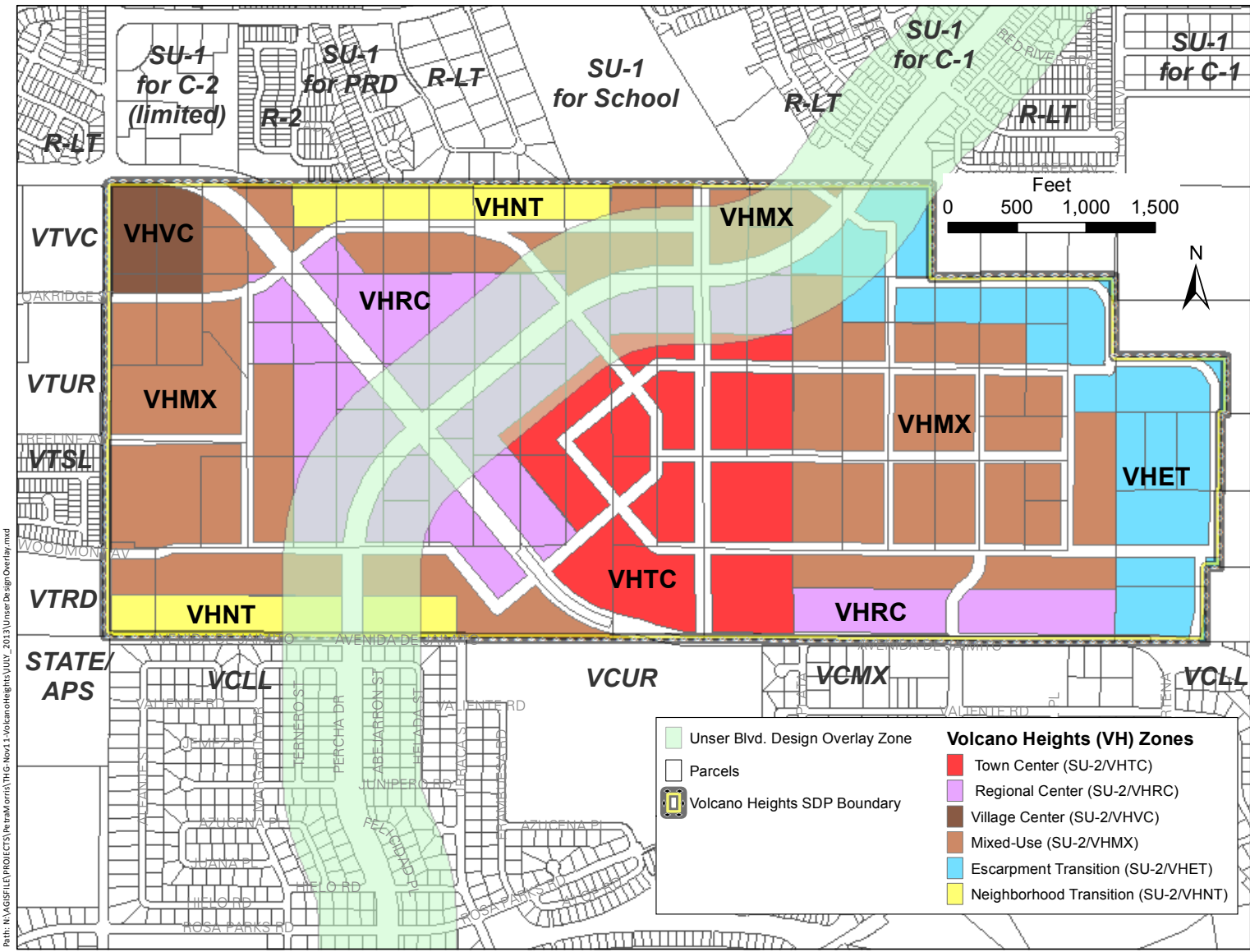

EXHIBIT 8.1 – UNSER DESIGN OVERLAY ZONE WITHIN THE VOLCANO HEIGHTS PLAN AREA

8.0 SIGN STANDARDS

R

TABLE 8.1 –SIGN TYPES BY CHARACTER ZONE

	CHARACTER ZONE	TOWN CENTER	REGIONAL CENTER	VILLAGE CENTER	MIXED-Use	NEIGHBORHOOD TRANSITION	ESCARPMENT TRANSITION	STANDARD
	SIGN TYPE							
S-1	Address Signs	P	P	P	P	P	P	Per City Zoning Code §14-16-3-5.
S-2	Attached Signs	P	P	P	P	P *	P *	<ul style="list-style-type: none"> For all ground floor commercial uses (retail, office, and restaurant): One sign per tenant space; area to be calculated at 1.5 SF per linear foot of tenant space façade along the public street frontage with a maximum of 100 SF per tenant. Second and upper floor commercial uses may also be permitted one second floor wall sign per tenant space per public street frontage; area to be calculated at 1.5 SF per linear foot of second or upper floor frontage along that public street with a maximum of 125 SF. Institutional uses (non-profits and churches): One sign per tenant space; area to be calculated at 1.5 SF per linear foot of public street frontage with a maximum of 100 SF. Live-Work and Home occupations: One sign limited to an area of 20 SF max. Building sign may encroach a maximum of 12 inches onto a sidewalk while maintaining a vertical clearance of 8 feet from the finished sidewalk if it is non-illuminated and 11 feet from the finished sidewalk if it is illuminated. [See also Section 11.2.8 starting on page 207.] Building signs may be internally or externally lit. Marquee signs as only permitted as specified below.
S-3	Banners	P	P	P	P	P	P	Per City Zoning Code §14-16-3-5.

8

* Commercial and live-work uses only.

TABLE 8.1 -SIGN TYPES BY CHARACTER ZONE (Cont'd)

	CHARACTER ZONE	TOWN CENTER	REGIONAL CENTER	VILLAGE CENTER	MIXED-USE	NEIGHBORHOOD TRANSITION	ESCARPMENT TRANSITION	STANDARD
SIGN TYPE								
S-4	Blade Signs, Building	P	P	P	P	P**	P**	<ul style="list-style-type: none"> • One per building (commercial and mixed use buildings only) • Area = 30 SF maximum per sign face. • May encroach a maximum of 6 feet over a sidewalk but shall not encroach over any parking or travel lane. [See also Section 11.2.8 starting on page 207.] • Building blade signs may be attached to the building at the corners of building or along any street-facing façade above the first floor façade. • Minimum vertical clearance from the finished sidewalk shall be 11 feet.
S-5	Blade Signs, Tenant	P	P	P	P	P**	P**	<ul style="list-style-type: none"> • One per commercial tenant space (retail, office, or restaurant use). • Area = 16 SF maximum per sign face. • May encroach a maximum of 4 feet over a public sidewalk, but shall not encroach over any parking or travel lane. [See also Section 11.2.8 starting on page 207.] • Tenant blade signs shall be oriented perpendicular to the building façade and hung under the soffit of an arcade or under a canopy/awning or attached to the building façade immediately over the ground floor tenant space while maintaining a vertical clearance of 8 feet from the finished sidewalk for non-illuminated signs and 11 feet from the finished sidewalk for illuminated signs.

** Commercial uses only.



8.0 SIGN STANDARDS

R

TABLE 8.1 –SIGN TYPES BY CHARACTER ZONE (Cont'd)

	CHARACTER ZONE	TOWN CENTER	REGIONAL CENTER	VILLAGE CENTER	MIXED-USE	NEIGHBORHOOD TRANSITION	ESCARPMENT TRANSITION	STANDARD
	SIGN TYPE							
S-6	Directory Signs	P	P	P	P	P	P	<ul style="list-style-type: none"> • Shall be allowed for all multi-tenant commercial and mixed-use buildings only. • One directory sign per multi-tenant building limited to 12 SF in area. • Freestanding directory signs shall not be permitted. Design of the sign shall be integral to the façade on which the sign is to be affixed.
S-7	Electronic Signs							Per City Zoning Code §14-16-3-5.
S-8	For Sale/For Lease Signs	P	P	P	P	P	P	<ul style="list-style-type: none"> • Size is limited to 32 SF per sign face. • All other standards are per City Zoning Code §14-16-3-5.
S-9	Interpretive Signs	P	P	P	P	P	P	Per Table 6.3.k in this Plan.
S-10	Marquee Signs	P	P	P	P	NP	NP	<ul style="list-style-type: none"> • Permitted for theaters, auditoriums, and other public gathering venues of 100 persons or more. • Marquee signs shall be attached to the building or located above or below a canopy only. • Area = 100 SF maximum. • Message board may be changeable copy (non-electronic). • Electronic message boards are regulated per City Zoning Code §14-16-3-5.
S-11	Monument Signs	P	P	P	P	NP	P**	<ul style="list-style-type: none"> • One monument sign per lot per lot street frontage (no more than 2 per lot separated by at least 100 feet) limited to a maximum of 75 SF per sign face and 6 feet in height.

** Commercial uses only.

8

TABLE 8.1 –SIGN TYPES BY CHARACTER ZONE (Cont'd)

	CHARACTER ZONE	TOWN CENTER	REGIONAL CENTER	VILLAGE CENTER	MIXED-USE	NEIGHBORHOOD TRANSITION	ESCARPMENT TRANSITION	STANDARD
	SIGN TYPE							
S-12	Private Open Space Amenity Contact Information Signs	P	P	P	P	P	P	<ul style="list-style-type: none"> • Sign edges shall be no more than 18 inches. • Lettering shall be no less than 1-inch high. • Contacts for maintenance and liability information shall be included.
S-13	Sandwich Board Signs	P	P	P	P	P	P	<ul style="list-style-type: none"> • Permitted only for retail, service, or restaurant uses. • Limited to 8 SF per sign face per storefront. • May not exceed 4 feet in height. • A minimum of 6 feet of sidewalk shall remain clear. • May use chalkboards for daily changing of messages. • Shall be removed every day after the business is closed.
S-14	Window Signs	P	P	P	P	P**	P**	<ul style="list-style-type: none"> • Limited to 10% of the window area. • In the Transition Zones, window signs are only permitted for commercial uses (including the “work” component of live-work uses). • The following shall be exempt from this limitation: <ul style="list-style-type: none"> • Addresses, closed/open signs, hours of operation, credit card logos, real estate signs, and now hiring signs. • Mannequins and storefront displays of merchandise sold. • Interior directory signage identifying shopping aisles and merchandise display areas.
S-15	Temporary Construction Signs	P	P	P	P	P	P	Per City Zoning Code §14-16-3-5.

** Commercial uses only.



This Page Left Intentionally Blank



9.0 OPEN SPACE, LANDSCAPING, AND SITE LIGHTING DESIGN STANDARDS

9.0 OPEN SPACE, LANDSCAPING, AND SITE LIGHTING DESIGN STANDARDS



9.1. Purpose / Intent: Open space standards are intended to provide a balance between the built and natural environments in order to provide open space that can help relieve pressures from urban areas. Open spaces are also meant to maintain the vital, geological, and cultural link to the volcanic escarpment and the petroglyphs.

9.2. Applicability

- 9.2.1. This Plan differentiates residential, mixed-use, and non-residential developments.
- 9.2.2. This Plan differentiates development projects by the following sizes: (1) less than 2 acres, (2) 2-5 acres, and (3) greater than 5 acres.

9.3. Open Space Requirements: All properties within Volcano Heights shall require both **Detached Open Space** and **Usable Open Space**. [See **Table 9.1** for Types of Open Space. See **Section 3.5** for definitions of all types of open space.]

- 9.3.1. **Detached Open Space** is required per the standards in **Section 9.4**.
- 9.3.2. **Usable Open Space** is required per the standards in **Section 9.5**.
- 9.3.3. Landscape strips within the public right-of-way shall not count as usable open space or detached open space provided on-site.

TABLE 9.1 – TYPES OF OPEN SPACE

OPEN SPACE TYPE	OWNERSHIP	MANAGEMENT	ACCESS	INCLUDED SPACES
Major Public Open Space (MPOS)	City	City	Public	Trails, trailheads, undeveloped recreation areas > 5 acres or acceptable to City Open Space Division
Usable open space	Private	Private	Private or Public*	<p><i>Developed: (including but not limited to)</i> courtyards, forecourts, balconies, porches, playgrounds, pools, sport courts, picnic areas, community gardens, amphitheatres, roof terraces or gardens, parks, plazas, paseos, and landscaped areas and/or buffers</p> <p><i>Undeveloped: (including but not limited to)</i> rock outcroppings, pristine setbacks and/or buffers around cultural or natural resources, pristine natural recreation areas</p>
Detached open space	Private	Private	Private or Public*	Developed or Undeveloped spaces provided <u>on-site</u> (see lists above)
	Public**	City	Public	See “Major Public Open Space” above

* Public access shall be granted at the property owner’s discretion via Public Access Easement filed with the City.

** Detached open space becomes public through dedication of undeveloped land within Volcano Heights acceptable to the City Open Space Division to the City via City Zoning Code §14-16-3-8(A).

9.0 OPEN SPACE, LANDSCAPING, AND SITE LIGHTING DESIGN STANDARDS

TABLE 9.2 – DETACHED OPEN SPACE: RESIDENTIAL USES

	VHTC	VHRC	VHVC	VHMX	VHNT	VHET	TOTAL
Available Acreage*	61.2	89.1	10.8	162	28.8	54.9	406.8
Detached OS Requirement (square feet/dwelling unit)	400	400	400	400	400	400	—
Detached OS Requirement Cap (dwelling unit/acre)	40	20	30	30	6	6	—
Intended Resulting Detached Open Space Acreage**	22	16	3	45	2	3	91

*Total acreage minus Primary Streets minus 10% for usable open space

** For purposes of analysis only

TABLE 9.3 – DETACHED OPEN SPACE: NON-RESIDENTIAL USES

	VHTC	VHRC	VHVC	VHMX	VHNT	VHET	TOTAL
Available Acreage*	61.2	89.1	10.8	162	28.8	54.9	406.8
Detached OS Requirement (square feet/30,000 SF building area)	2,400	2,400	2,400	2,400	NA	NA	—
Maximum Stories with Height Bonus	5	4	4	3	NA	NA	—
Intended Total Detached Open Space Acreage**	17	20	3	27	0	0	66

*Total acreage minus Primary Streets minus 10% for usable open space

** For purposes of analysis only

9.4. Detached Open Space Standards

9.4.1. **Purpose / Intent:** Detached open space is required to help provide relief from density to balance the urban environment of the proposed Major Activity Center. In addition, **detached open space** is intended to help preserve the integrity and fabric of this unique natural, cultural, geological, and volcanological area.

The detached open space requirements below are calibrated to result in desired development densities with enough open space to preserve **rock outcroppings** [see **Exhibit 9.1**] and other **sensitive lands** as well as to create private parks and other civic and open space amenities through optional height bonuses in the non-Transition Zones.

9.4.2. **Detached open space** standards are a zoning regulation separate from any subdivision regulations, such as those associated with Impact Fees. The City calculates and tracks these fees and any associated credits separately. The detached open space standards shall not count toward Subdivision Impact Fee credits associated with **parks and/or open space**.

9.4.3. **Detached open space** standards are separate from the **usable open space** requirement.

9.4.4. **Detached open space** may be counted toward optional height bonus criteria. [See **Section 6.4** starting on page 111.]

9.0 OPEN SPACE, LANDSCAPING, AND SITE LIGHTING DESIGN STANDARDS

9.4.5. **Detached open space** shall be provided via the alternatives listed in the City Zoning Code §14-16-3-8(A): (1) on-site, (2) dedication, or (3) cash-in-lieu. Dedications shall be for undeveloped land within Volcano Heights acceptable to the City Open Space Division.

9.4.6. **Residential or Mixed-Use Development:** Following the intent of the R-D Zoning per City Zoning Code §14-16-2-14(F) that these SU-2 zones have replaced in Volcano Heights, for all residential or mixed-use development, 400 SF of **detached open space** shall be provided per residential dwelling unit until the density threshold (i.e. dwelling unit per acre) per **Table 9.2** is reached on the site. This regulation and density threshold for each zone have been analyzed and calibrated to achieve a target open space acreage that can balance the density/intensity of proposed development as well as help to protect the **rock outcroppings** and **sensitive lands** within the Plan area.

9.4.7. **Non-Residential Development:** Following the intent to preserve open space in Developing Urban areas per City Zoning Code §14-16-3-18, for all exclusively non-residential developments, a minimum of 2,400 SF of open space shall be provided for every 30,000 SF of building area. [See **Table 9.3** on page 143.] This regulation has been analyzed and calibrated to achieve a target open space acreage that can balance the density/intensity of proposed development as well as help to protect the **rock outcroppings** and **sensitive lands** within the Plan area.

9.5. Usable Open Space Standards

9.5.1. All sites in Volcano Heights shall provide a minimum of 10% of their site acreage as **usable open space** on-site with the following exception:

- (i) Usable open space is not required for mixed-use or non-residential properties if located within 1,500 feet of a **park, plaza** or other **usable open space** that is at least one acre in size and accessible to the public.

9.5.2. Up to 60% of the required 10% of **usable open space** may be transferred across property lines and/or pooled to create larger open space areas within the Volcano Heights Plan area. In this event, the development and open space improvements shall be constructed concurrently.

9.5.3. When phasing of a Site Development Plan is involved, each phase must meet the 10% **usable open space** requirement. Subsequent phases shall not be built until the preceding phase's usable open space has been built and/or landscaped. Under no circumstances shall the **applicant** be allowed to defer providing and developing the required open space for each phase.

9.5.4. Required Amenities on Usable Open Space by Project Size

- (i) **Projects 5+ Acres:** As part or all of their required **usable open space**, projects greater than 5 acres shall incorporate a publicly accessible **plaza/patio/courtyard**, or **amphitheater** a minimum of 5,000 SF in size. This may be counted toward an optional height bonus. [See **Table 6.2** for criteria, **Table 6.3** for standards, and **Table 9.4** for **private open space** standards.]

9.0 OPEN SPACE, LANDSCAPING, AND SITE LIGHTING DESIGN STANDARDS

- (ii) **Projects 2-5 Acres**
 - a. *Residential:* Projects 2-5 acres in size that are exclusively residential development shall incorporate a recreational area or playground a minimum of 2,400 SF in size as part or all of their required usable open space, which can also count toward an optional height bonus. [See **Table 6.2** for criteria, **Table 6.3** for standards, and **Table 9.4** for private open space standards.]
 - b. *Non-residential or Mixed Use:* Projects 2-5 acres in size that are non-residential or mixed use shall incorporate a publicly accessible plaza/patio/courtyard, amphitheater, or roof garden at least 1,500 SF in size, which can also count toward an optional height bonus [86]. [See **Table 6.2** for criteria, **Table 6.3** for standards, and **Table 9.4** for private open space standards.]
 - (iii) **Projects <2 acres:** Projects less than 2 acres in size may incorporate any combination of open space elements to satisfy the 10% **usable open space** requirement. [See **Table 9.4** for **private open space** standards.]
- 9.5.5. A minimum of 40% of the required on-site **usable open space** shall be permeable to rainwater. This requirement may be met through landscape area, **permeable paving**, unpaved pedestrian walkways, etc. This area may be broken up on the site but shall remain accessible and intended for public use.
- 9.5.6. Any developed **usable open space** (i.e. **plaza, amphitheater, playground**, etc.) shall include a landscaped portion equal to a minimum of 40% of the on-site usable open space. A minimum of 25% of all **developed open space** shall be shaded from the summer sun with trees and/or permanent or temporary shade structures.
- 9.5.7. All living material (i.e. plants, trees, etc.) shall be irrigated per City standards. [Contact the City **DRC** Section for the latest standards.] If native species are chosen from the Plant List in **Table 9.5** in this Plan [see also **Section 9.7.3** starting on page 151], irrigation shall be provided for a minimum of the first three (3) growing seasons or until the plant/tree is firmly established.
- 9.5.8. All private open space, regardless of public access, shall be privately owned and the responsibility of property owners/developers for the cost of construction, ongoing maintenance, and liability. These costs may be privately funded through homeowner or merchants associations. [In the event that they are ever dedicated to the City for ongoing maintenance and liability responsibility, open space amenities must meet City standards and be acceptable to and accepted by the relevant City department.]
- 9.5.9. Any **open space** amenity as provided per criteria in **Table 9.4** starting on page 148 shall count toward satisfying the 10% **usable open space** requirement. **Table 9.4** identifies whether each amenity is eligible for access by the public (i.e. civic open space), private only, or both.

9.0 OPEN SPACE, LANDSCAPING, AND SITE LIGHTING DESIGN STANDARDS

[Amended
November 5, 2014]



9

9.5.10. For all non-residential or mixed-use projects, usable open space on-site shall be open and accessible to the general public, with the exception of balconies, porches, **courtyards**, and **community gardens**.

- (i) Private open space accessible by the public and intended for public use is defined by this Plan as **Civic Open Space**. Such open space is privately owned, controlled, maintained, and managed. The property owner retains all property rights and responsibilities, including the rights to limit the hours of accessibility and enforce rules of conduct, dress, etiquette, etc.
- (ii) All open space areas shall connect to public pedestrian walkways. If not easily identifiable from the **abutting** walkway, as determined by the Planning Director or his/her designee, signage must be provided to direct the public.
- (iii) A public access easement shall be granted to provide public access to **private open space** amenities.
- (iv) Private open space amenities accessible to the public shall be marked with a sign with contact information for the party responsible for maintenance and liability. [See **Table 8.1** starting on page 136 for sign standards.]

9.5.11. **Rock Outcroppings:** Significant **rock outcroppings** that are preserved shall count double their square footage as a landscaped area. [See **Section 3.5** starting on page 40 for definition and **Exhibit 9.1** on page 147 for locations and sizes.]

9.6. **Petroglyphs:** All rock outcroppings containing petroglyphs shall be protected per **Section 6.6.6** starting on page 119. Any buffers or setbacks included as part of a treatment plan may be counted as usable open space.

9.0 OPEN SPACE, LANDSCAPING, AND SITE LIGHTING DESIGN STANDARDS

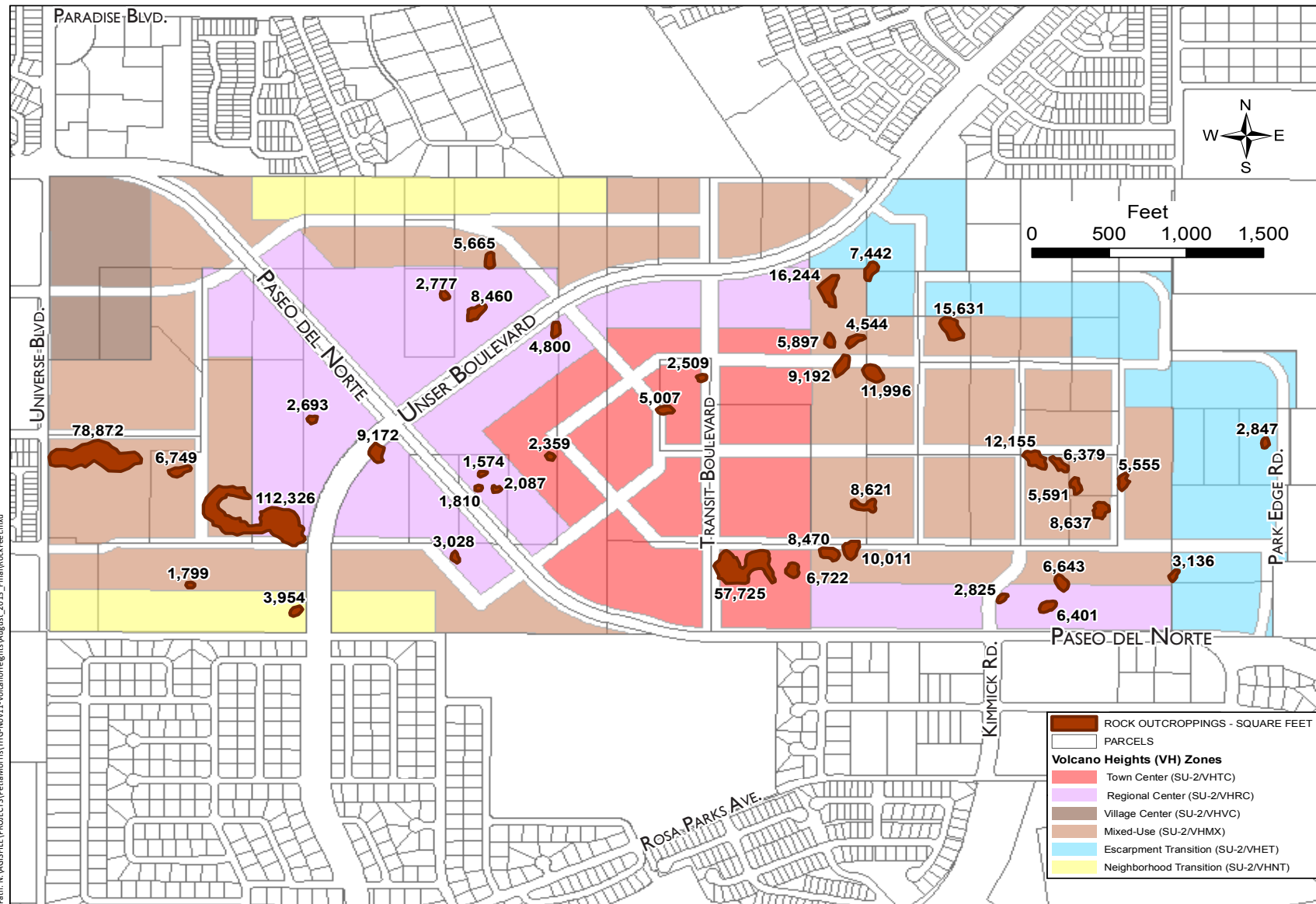

Note: 1 acre = 43,560 square feet

EXHIBIT 9.1 – SIGNIFICANT ROCK OUTCROPPINGS

9.0 OPEN SPACE, LANDSCAPING, AND SITE LIGHTING DESIGN STANDARDS

TABLE 9.4 – OPEN SPACE CRITERIA

PRIVATE OPEN SPACE TYPE	STANDARDS AND CRITERIA	ACCESS (Civic, Private, or Both)
(i) Amphitheater	<ul style="list-style-type: none"> Size, scale, and architectural style shall complement adjacent development. Noise shall be governed by the City Noise Ordinance [Article 9 of Building and Safety: ROA 1994 Sec. 9-9]. Hours of operation shall be assessed on a case-by-case basis. 	Private
(ii) Ancillary Structure	<ul style="list-style-type: none"> Ancillary structures shall have at least one open side and may have a roof or other means of providing shade. Architectural style and materials shall complement surrounding development, but size and scale shall be subordinate to surrounding buildings. Ancillary structures may be located at prominent locations within an appropriate civic or open space and may include casual seating areas. Ancillary structures in Mixed Use zones may have minor commercial uses, such as small food or news vendors, but may also serve as civic elements for general public use with more passive activities. Ancillary structures located within the Escarpment Transition zone should be more modest in use and character, ranging from a simple, public pavilion or pergola to a neighborhood kiosk or mail pavilion. 	Both
(iii) Balcony	<ul style="list-style-type: none"> Balconies that are not flush shall be a minimum of 5 feet clear in depth and a minimum of 8 feet in width. Balconies may be semi-recessed or recessed. 	Private
(iv) Community Garden	<ul style="list-style-type: none"> Maximum size shall be 1 acre. Gardens may be enclosed by a fence on all open sides. Fences should be installed straight and plumb, with vertical supports at a minimum of 8' on center. Chicken wire may only be used in conjunction with another permitted fencing material and must be supported along all edges. <p><u>Fencing Materials:</u></p> <ul style="list-style-type: none"> <i>Permitted:</i> pressure treated wood (must be painted or stained medium to dark color), chicken wire, wrought iron, painted galvanized steel <i>Not permitted:</i> Materials such as but not limited to chain link, barbed or razor wire and/or tape, vinyl, un-painted/stained pressure treated wood, plywood 	Both

9.0 OPEN SPACE, LANDSCAPING, AND SITE LIGHTING DESIGN STANDARDS

TABLE 9.4 – OPEN SPACE CRITERIA *(Cont'd)*

PRIVATE OPEN SPACE TYPE	STANDARDS AND CRITERIA	ACCESS <i>(Civic, Private, or Both)</i>
(v) Courtyard	<ul style="list-style-type: none"> • Courtyards shall be surrounded on all sides by buildings with at least one pedestrian connection to an adjoining building or public sidewalk. • The courtyard shall be a minimum of 200 SF. • Courtyard may be landscaped or a combination of landscape and hardscape. However, they shall contain amenities for residents such as seating, water features, etc. 	Both
(vi) Forecourt	<ul style="list-style-type: none"> • A forecourt shall be surrounded on at least two sides by buildings. • A forecourt shall be a minimum of 150 SF. 	Both
(vii) Landscaped Traffic Circle	<ul style="list-style-type: none"> • Shall be designed, landscaped, and irrigated per City standards. [Contact City DRC Section for the latest standards.] • Planting shall not exceed maximum height requirements so that views are not obstructed. 	Civic
(viii) Landscape Strip <i>(in addition to required streetscaping)</i>	<ul style="list-style-type: none"> • Shall exceed required streetscaping by at least 25% in area. • Shall be compatible with required streetscaping in design and function. • Shall be designed, landscaped, and irrigated per City standards. [Contact City DRC Section for the latest standards.] • Only permeable surfaces shall be used. 	Civic
(ix) Park	<ul style="list-style-type: none"> • Parks shall be a minimum of 2 acres in size, with slopes no greater than 5 to 1. • There shall be street frontage with on-street parking on at least 2 sides. • Where a park abuts commercial uses on three (3) or more sides at the time of the park's approval, the property owner shall be required to provide a shared parking agreement with at least one (1) property owner on which a commercial use is located. Once constructed, the park's property owner shall provide signs visible to the public from the shared parking area explaining the terms of the shared use agreement. • Seating and shade covering at least 25% of the area shall be provided. • Co-location of drainage facilities shall be evaluated on a case-by-case basis. • Parks shall be built to City Standards and Specifications. 	Both
(x) Paseo	<ul style="list-style-type: none"> • Shall include a hardscaped pathway with pervious pavers. • Shall be primarily defined by building façades. • Shall be wide enough to ensure sunlight (12-foot minimum) and incorporate shade trees. • Shall be designed to complement the character of surrounding buildings. • Shall be landscaped and irrigated per City standards. [Contact City DRC Section for the latest standards] 	Both

9.0 OPEN SPACE, LANDSCAPING, AND SITE LIGHTING DESIGN STANDARDS

TABLE 9.4 – OPEN SPACE CRITERIA (Cont'd)

PRIVATE OPEN SPACE TYPE	STANDARDS AND CRITERIA	ACCESS (Civic, Private, or Both)
(xi) Permeable Landscaped Area	<ul style="list-style-type: none"> • Shall be designed, landscaped, and irrigated per City standards. [Contact City DRC Section for the latest standards.] • Shall be constructed and use materials to allow rain or stormwater to infiltrate the ground. 	Both
(xii) Playground	<ul style="list-style-type: none"> • Playgrounds shall be a minimum of 400 SF. • Landscaping shall be provided on 80% of the area. • Seating and shade covering at least 25% of the area shall be provided. • Playground equipment and design shall be reviewed and approved by the City prior to installation. 	Both
(xiii) Plaza	<ul style="list-style-type: none"> • Plazas shall be a minimum of 0.25 acre (10,890 SF) and maximum of 1 acre. • Building frontages shall define these spaces. Plazas shall front at least one (1) street, preferably at the intersection of important streets. The landscape should consist primarily of hardscape. Casual seating, along with tables and chairs and/or benches, should be provided. 	Both
(xiv) Private Open Space Amenities (pool, play courts, picnic area, etc.)	<ul style="list-style-type: none"> • Such private open space may be incorporated with roof terraces or courtyards based on the appropriateness of the design and accommodation of privacy. 	Private
(xv) Pedestrian walkway to Rock Outcroppings	<ul style="list-style-type: none"> • Pedestrian walkways to dedicated rock outcroppings shall be asphalt, cement, crusher fines stabilized with binder, or other materials deemed acceptable by the City Open Space Division. • Pedestrian walkways that connect more than one rock outcropping are eligible for up to 10 additional bonus points as deemed appropriate by the Planning Director or his/her designee. 	Private
(xvi) Recreation Area	<ul style="list-style-type: none"> • Shall be limited to minimal site improvements, including landscaping. • Impermeable surfaces shall not be permitted. • No more than 25% of the gross area shall be seating and/or permanent shading. • No more than 5 parking spaces shall be allowed. 	Both
(xvii) Roof Garden or Roof Terrace	<ul style="list-style-type: none"> • A Roof Garden shall at least be 50% of the building footprint area. • A Roof Terrace shall provide landscaping in the form of potted plants, seating, and other amenities for the users of the building. • A Roof Terrace may also include a portion of the roof as a green roof which may or may not have public access. 	Both

9.0 OPEN SPACE, LANDSCAPING, AND SITE LIGHTING DESIGN STANDARDS

9.7. Landscaping Standards

9.7.1. Landscaped Areas

- (i) Landscaped areas shall be covered with a minimum of 75% living vegetative materials, such as trees, grasses, vines, flowers, and/or bushes/shrubs. Coverage shall be calculated from the expected average size of mature plants.
- (ii) Where a property owner includes a transit shelter, any paved areas shall count as landscaped areas.

9.7.2. **On-Lot Trees:** Where buildings are placed more than 10 feet from a street-side property line, at least one tree shall be planted per property within the street-side **setback**. Properties with a street frontage over 100 feet shall have a minimum of one tree for every 40 feet. Trees shall be maintained by the property owner.

- (i) **Native Species Requirement:** For properties within 200 feet of the Petroglyph National Monument, only tree species listed as native in the Plant List in **Table 9.5** may be used. [See also **Section 9.7.3.**]
- (ii) **Plant List:** For properties 200 feet or more from the Petroglyph National Monument, any tree species listed in the Plant List in **Table 9.5** may be used. [See also **Section 9.7.3.**]

9.7.3. Plant Lists

- (i) **Purpose/Intent:** The purpose of regulating plants is to reduce water use, maintain the character of native plants now existing in the Petroglyph National Monument, and provide a harmonious landscape.
- (ii) **Landscaping:** Appropriate plants shall be chosen from the Plant List in **Table 9.5** for landscaping within the Plan area. Shrubs and trees shall be nursery grown in order to minimize poaching from the Monument and Major Public Open Space.
 - a. **Native Species Requirement:** Within 200 feet of the Petroglyph National Monument or other **Major Public Open Space**, only plants and trees listed as native in the Plant List in **Table 9.5** shall be used in order to limit impact of invasive and/or non-native plants on native vegetation, except for street trees. [See **Section 11.3.5** starting on page 208. for details about street trees.] Native plant species were selected from a list compiled during an inventory within the Petroglyph National Monument by the National Park Service in 1994-1995, including almost 200 plants (amended).

[Amended
November 5, 2014]

9.0 OPEN SPACE, LANDSCAPING, AND SITE LIGHTING DESIGN STANDARDS

[Amended
November 5, 2014]

- b. *Plant List Requirement:* Two-hundred (200) feet or more from the Petroglyph National Monument or other Major Public Open Space, any plant from the Plant List in **Table 9.5** may be used. In addition to species native to the Petroglyph National Monument, additional plant species were selected from the official xeric or low-water use plant list of the Albuquerque Bernalillo County Water Utility Authority (ABCWUA).
- (iii) **Streetscaping:** See **Section 11.3.5** starting on page 208.
- (iv) **Construction Mitigation:** Land disturbed in development shall be re-vegetated using either native or xeric plants as appropriate from the Plant List in **Table 9.5**. [See also **Section 6.6** starting on page 118.]

9.0 OPEN SPACE, LANDSCAPING, AND SITE LIGHTING DESIGN STANDARDS

[Amended
November 5, 2014]

TABLE 9.5 – PLANT LIST (TREES)

SCIENTIFIC NAME	COMMON NAME	NATIVE OR XERIC	DECIDUOUS OR EVERGREEN	APPROX. HEIGHT X WIDTH AT MATURITY (in ft.)
<i>Cercocarpus ledifolius</i>	Curlleaf mountain mahogany	Xeric	Evergreen	12 x 8
<i>Chilopsis linearis</i>	Desert willow	Native	Deciduous	20 x 20
<i>Juniperus monosperma</i>	Oneseed juniper	Native	Evergreen	15 x 15
<i>Juniperus scopulorum</i>	Rocket Mountain juniper, female	Xeric	Evergreen	40 x 20
<i>Juniperus virginiana</i>	Juniper, female	Xeric	Evergreen	20 x 10
<i>Leucana retusa</i>	Golden ball leadtree	Xeric	Deciduous	15 x 15
<i>Melia azedarach</i>	Chinaberry	Xeric	Deciduous	25 x 20
<i>Prosopis glandulosa</i>	Honey mesquite	Xeric	Deciduous	25 x 30
<i>Prosopis pubescens</i>	Screwbean mesquite	Xeric	Deciduous	20 x 20
<i>Prosopis torreyana</i>	Western honey mesquite	Xeric	Deciduous	18 x 20
<i>Prosopis velutina</i>	Velvet mesquite	Xeric	Deciduous	20 x 25
<i>Quercus grisea</i>	Gray oak	Xeric	Evergreen	30 x 30
<i>Quercus suber</i>	Cork oak	Xeric	Evergreen	30 x 30
<i>Quercus turbinella</i>	Shrub live oak	Xeric	Evergreen	18 x 20
<i>Sambucus mexicana</i>	Mexican elder	Xeric	Deciduous	20 x 25
<i>Sapindus drummondii</i>	Western soapberry	Xeric	Deciduous	30 x 30
<i>Zizyphus jujuba</i>	Jujube	Xeric	Deciduous	25 x 25

9.0 OPEN SPACE, LANDSCAPING, AND SITE LIGHTING DESIGN STANDARDS

[Amended
November 5, 2014]

TABLE 9.5 – PLANT LIST (SHRUBS)

SCIENTIFIC NAME	COMMON NAME	NATIVE OR XERIC	DECIDUOUS OR EVERGREEN	APPROX. HEIGHT X WIDTH AT MATURITY (in ft.)
Agave sp.	Agave	Native	Evergreen	varies
Artemisia filifolia Torr	Sand sage	Native	Evergreen	3 x 3
Atriplex canescens	Fourwing saltbrush	Native	Deciduous	5 x 5
Brickellia californica	California brickellbush	Native	Deciduous	3 x 3
Dalea sp.	Purple sage	Native	Deciduous	5 x 5
Dasyilirion sp.	Sotol	Xeric	Evergreen	5 x 5
Fallugia paradoxa	Apache plume	Native	Deciduous	5 x 5
Fouquieria splendens	Ocotillo	Xeric	Deciduous	15 x 10
Krascheninnikovia lanata	Winterfat	Native	Deciduous	5 x 5
Nolina microcarpa	Beargrass	Xeric	Evergreen	5 x 6
Opuntia sp.	Prickly pear	Native	Evergreen	varies
Rhus trilobata	Skunkbush sumac	Native	Deciduous	3 x 3
Ribes sp.	Gooseberry	Native	Deciduous	5 x 3
Yucca sp.	Yucca	Native	Evergreen	varies

9.0 OPEN SPACE, LANDSCAPING, AND SITE LIGHTING DESIGN STANDARDS

TABLE 9.5 – PLANT LIST (FORBS, GRASSES, AND GROUNDCOVERS)

[Amended
November 5, 2014]

SCIENTIFIC NAME	COMMON NAME	NATIVE OR XERIC	APPROX. HEIGHT X WIDTH AT MATURITY (in inches)
<i>Abronia villosa</i>	Sand verbena	Native	1 x 4
<i>Andropogon saccharoides</i>	Silver beardgrass	Native	2.5 x 2
<i>Aristida purpurea</i>	Purple threeawn	Native	1 x 1
<i>Artemisia ludoviciana</i>	Prairie sage or white sagebrush	Native	3 x 3
<i>Asclepias speciosa</i>	Showy milkweeds	Native	2 x 3
<i>Baileya multiradiata</i>	Desert marigold	Native	varies
<i>Bouteloua curtipendula</i>	Sideoats grama	Native	2 x 1
<i>Bouteloua gracilis</i>	Blue grama	Native	1 x 1
<i>Bouteloua eriopoda</i>	Black grama	Native	1 x 1
<i>Elymus elymoides</i>	Bottlebrush squirreltail	Native	varies
<i>Eriogonum annuum</i>	Annual buckwheat	Xeric	1-5 x 2
<i>Gaillardia pulchella</i>	Firewheel	Native	varies
<i>Hilaria jamesii</i>	Galleta	Native	2 x 1
<i>Linum perenne lewisii</i>	Blue flax	Xeric	2 x 2
<i>Mirabilis</i> sp.	Four o'clock	Native	1 x 4
<i>Muhlenbergia porteri</i>	Bush muhly	Native	varies
<i>Oenothera</i> sp.	Evening primrose	Native	1.5 x 4
<i>Oryzopsis hymenoides</i>	Indian ricegrass	Native	varies
<i>Parthenium incanum</i>	Mariola	Native	varies
<i>Penstemon ambiguous</i>	Beardtongue	Native	2 x 1
<i>Phacelia integrifolia</i>	Scorpionflower	Native	1 x 1
<i>Philostrophe taetina</i> (also <i>Psilostrophe taetina</i>)	Paperflower	Native	3 x 3
<i>Sporobolus cryptandrus</i>	Sand dropseed	Native	varies
<i>Zinnia grandiflora</i>	Desert zinnia	Xeric	varies

9.0 OPEN SPACE, LANDSCAPING, AND SITE LIGHTING DESIGN STANDARDS

9.7.4. Walls & Fences Material Finishes & Design

(i) Height & Placement

- a. Walls and fences shall not exceed a height of 36 inches where allowed within street-facing setbacks (except for columns that support arcades or trellises). Solid fences and walls shall not exceed a height of 72 inches, inclusive of retaining walls, inside required setbacks along rear and interior side property lines. Retaining walls in all locations shall not exceed 48 inches, unless approved by the City Hydrologist. Height shall be measured from the lower side on the public side of the side or rear yard. Public utility structures are excluded from these requirements.
- b. Where a grade change exists between two properties and a retaining wall is deemed necessary, per the City Hydrologist, up to 24 additional inches of transparent fence material (but not chain-link fencing) is permitted on top of a solid wall or fence.
- c. Where new single-family residential lots and homes back up to Connector streets, solid rear and/or side-yard walls bordering the street and pedestrian realm shall not exceed a height of 48 inches. Twenty-four (24) additional inches of transparent fence material (but not chain-link fencing) are permitted above the solid portion of the wall.

[Amended
November 5,
2014]

- (ii) **Adjacency to Monument and City Major Public Open Space:** Properties **abutting** the Petroglyph National Monument and/or **Major Public Open Space** shall use coyote fencing, post and wire (not barbed), or view fencing. View fencing allows for a general sense of openness, visual transparency, and passive surveillance, while still maintaining perimeter security.
- (iii) **Design & Prohibited Materials:** Wood board, cyclone, chain link, and barbed and/or razor wire and/or tape fencing are prohibited except at public utility structures. The end of walls shall have a pier or **pilaster** at least 12 inches wide to give a substantial appearance. Use of block to create patterns is encouraged.
 - a. **Perimeter Walls:** Exposed plain block, including all colors, is not allowed on walls visible from or **adjacent** to the public **ROW, private open space**, or private or public **parks**.
 - b. **Site Walls:** Block walls not visible from or **adjacent** to the public **ROW, private open space** or **Major Public Open Space**, or private or public **parks** must have integral color (i.e. plain, grey cement blocks are prohibited).
 - c. **Color:** In order to assure durability and minimize the visual impact of development, stucco and concrete shall have an integral color with a “light reflective value” (LRV) rating within the range of 20-50 percent [See **Exhibit 7.1** on page 127.]
 - d. **Screen Walls:** See **Section 6.8. Street Screens** starting on page 123.

9.0 OPEN SPACE, LANDSCAPING, AND SITE LIGHTING DESIGN STANDARDS

- e. **Living Fence:** A living fence shall be a minimum of three feet tall, which may include an earth berm, with vegetation dense and tall enough at maturity to provide sufficient screening and/or sense of delineation. Appropriate species shall be selected from the Plant List in **Table 9.5** starting on page 153. Additional low-water, non-invasive species may be used to supplement the living fence if approved by the Planning Director and City Open Space Division.
- 9.7.5. **Pedestrian Walkways:** In surface parking lots, pedestrian walkways shall not extend more than 75 feet without one of the following features to provide shade, spatial definition, and pedestrian-friendly amenities:
- (i) arcades,
 - (ii) trellises,
 - (iii) shade structures, and/or
 - (iv) trees.
- 9.7.6. **Gateway Monuments:** Pillars or walls are permitted at entry points to neighborhoods and developments. Walls shall not be more than 12 feet long and conform with **Section 9.7.4** in this Plan. Pillars shall not be more than 3 feet wide and 10 feet high. Pillars and walls shall be stucco, masonry, rammed earth, adobe, native stacked stone (or synthetic equivalent), or straw bale. Exposed plain block, of any color, is not allowed. Stucco and concrete shall have an integral color other than grey.
- 9.7.7. **Rainwater Quality and Management**
- (i) Sites shall be required to retain the **first flush storm event**. It may be possible to employ a regional solution.
 - (ii) All new developments shall incorporate **water harvesting** methods to supplement landscape irrigation. Water harvesting shall capture the first 1/2-inch of rainfall. Parking surfaces and other impermeable surfaces shall route rainwater through water harvesting areas on-site with 5% grade or less. [See also **Section 6.8.8** starting on page 123 for screening requirements.]
 - (iii) Where appropriate, development projects shall incorporate unobtrusive rainwater features that facilitate the detention and infiltration of rainwater and the filtration of pollutants from urban run-off. [See also policies in **Section 13.5.3** starting on page 242.] At all densities and intensities, appropriate techniques include:
 - a. permeable pavers & concrete,
 - b. infiltration beds placed below paved areas,
 - c. stone-filled reservoirs and dry-wells,
 - d. roof storage systems & cisterns designed with materials allowed by this Plan,
 - e. small “rain gardens” (low-lying with moisture-tolerant grasses, wildflowers, shrubs, and trees), and
 - f. vegetated swales (in **courtyards**, street medians, and landscape strips).

9.0 OPEN SPACE, LANDSCAPING, AND SITE LIGHTING DESIGN STANDARDS

- (iv) Materials and treatments used for rainwater management shall be natural in appearance. Channels lined by concrete or rip-rap are prohibited, unless necessary for public safety.
- (v) The potential impacts of water retention shall be thoroughly studied prior to use of detention areas to control flows.
- (vi) Fencing of detention ponds shall be avoided. The bottom slopes of detention basins shall be designed for safety. In addition, a hydrological study and design may be required of new development by the City of Albuquerque to identify appropriate rainwater detention and energy dissipation features.
- (vii) Within large unbuilt areas, developed flows shall be modified through check dams or other means to approximate undeveloped flows to minimize impacts on the Escarpment and to minimize the intensity of channel treatment required. The impact of check dams as a method of controlling flows shall be thoroughly studied prior to their use.
- (viii) Developed flows shall be managed to minimize their impact on **Major Public Open Space**, Northern Geologic Window, archeological sites, and the Escarpment.
- (ix) Developed flows into the Petroglyph National Monument shall not be permitted in excess of, or more concentrated than, natural flows and shall require approval by City Open Space Division in coordination with the National Park Service.
- (x) Developments that propose more than 4 feet of fill shall be required to go through the **DRB** for **approval** and require sign-off from the City Hydrologist.
- (xi) All developments within the Impact Area as defined by the NWMEP shall be required to go through the **DRB** for **approval** and require sign-off from the City hydrologist.

9.0 OPEN SPACE, LANDSCAPING, AND SITE LIGHTING DESIGN STANDARDS

9.7.8. Channel Design

- (i) **Purpose/Intent:** Improved naturalistic channel design shall retain as much undisturbed desert vegetation and rock formations insofar as practicable.
- (ii) **Channel Treatments:** Shall meet the following requirements:
 - a. Limited stabilization of natural channels, according to the policies contained in the City of Albuquerque Facility Plan for Arroyos, unless such treatment is determined to be infeasible by the City Hydrologist or the Albuquerque Metropolitan Area Flood Control Authority (AMAFCA) as appropriate.
 - b. Use of many small, unobtrusive structures, such as check dams or small drop structures, rather than larger, more obtrusive structures, when structural solutions are required.
 - c. Use of materials in treated channels that blend visually with the Escarpment and **adjacent** open space. Naturalistic treatments are the preferred treatment types.
 - d. Protection of canyons from erosion through control of developed flows and through stabilization techniques that are consistent with the visual character of the open space.

[Amended
November 5, 2014]

9.8. Site Lighting Standards

- 9.8.1. Lighting shall have a cut-off angle that directs light downward and only toward the property on which the light source is located, per the New Mexico Night Sky Ordinance [74-12-1 to 74-12-10 NMSA 1978]. Light fixtures shall be of a type that throws light downward and have baffles, hoods or diffusers so that no light point source shall be visible from a distance greater than 1,000 feet. On-site light poles shall not exceed a height of 16 feet. High-intensity discharge lamps and sodium lamps shall not be used.
- 9.8.2. All new developments shall provide pedestrian-scaled streetlights. [See **Section 11.4** starting on page 209.]
- 9.8.3. Shoe box style lighting shall not be used, except in parking areas of 100 or more spaces. Metal halide lights are encouraged. High pressure sodium lights are discouraged since they visually render all colors the same.

[Amended
November 5, 2014]

This Page Left Intentionally Blank



CHAPTER III

street and streetscape standards

This Page Left Intentionally Blank



10.0 STREET STANDARDS

10.0 STREET STANDARDS

10.1. Purpose/ Intent: Streets in Volcano Heights need to support the overall intent and character of each corridor. They should balance all forms of mobility while maximizing convenience for residents and visitors. Streets are also used to convey drainage and support **water harvesting**. **Auto-oriented** streets serve more regional trips as well as providing access for service, trucking, and maintenance for non-residential uses.

10.2. Applicability: Street and streetscape standards apply to all streets and development within Volcano Heights.

10.2.1. Streets within Volcano Heights are to be designed and constructed per the standards in this Plan.

[Amended November 5, 2014] 10.2.2. Bicycle facilities, including on-street bicycle lanes and multi-use trails, should be designed and developed to meet safety considerations as provided in the Institute for Transportation Engineers (ITE) or American Association of State Highway Transportation Officials (AASHTO) standards.

10.2.3. Streetscape standards address all elements between the building face and edge of the curb. Typical streetscape elements addressed are street trees, lighting, street furniture and pedestrian amenities, and materials.

10.2.4. Street cross sections have been carefully designed to work with frontage requirements in the Site Development Standards for each **character zone** in order to provide a consistent, predictable built environment along corridors, across property lines, and over time.

10.2.5. These standards may be adjusted by the **DRB** per the thresholds and criteria specified in **Table 10.1** on page 168.

- (i) Any adjustments needed that exceed these thresholds, including the following, will require **EPC** approval to ensure the Plan's intent and purpose are still met with the proposed changes:
 - a. Eliminating a street cross section element and/or
 - b. Adjusting a dimension beyond the 20% that **DRB** can grant.
- (ii) Changes to a Primary Street cross section may only be due to utility use, drainage requirement, engineering for safety, or to respond to site context.
- (iii) The applicant is to provide engineering drawings demonstrating the need for an adjustment to the street cross section and proposing an improved cross section that works for the project site and adjacent sites, while still meeting the intent of this Plan.

10.2.6. Maintenance of all streetscape is to be per City Code of Ordinances Chapter 6, Article 5. [See **Section 13.3.13** starting on page 236 for policies relating to roles and responsibilities for maintenance.]

10.3. How to Use These Standards

10.3.1. **Cross Sections:** The cross sections in Volcano Heights are designed to accommodate all modes of transportation safely, with a special emphasis on creating a high-quality pedestrian environment that can contribute to the success of the Major Activity Center. For this reason, travel lane widths are minimized to help calm traffic and reduce crossing distances for pedestrians. Travel lanes where transit is anticipated are planned for 12 feet wide.

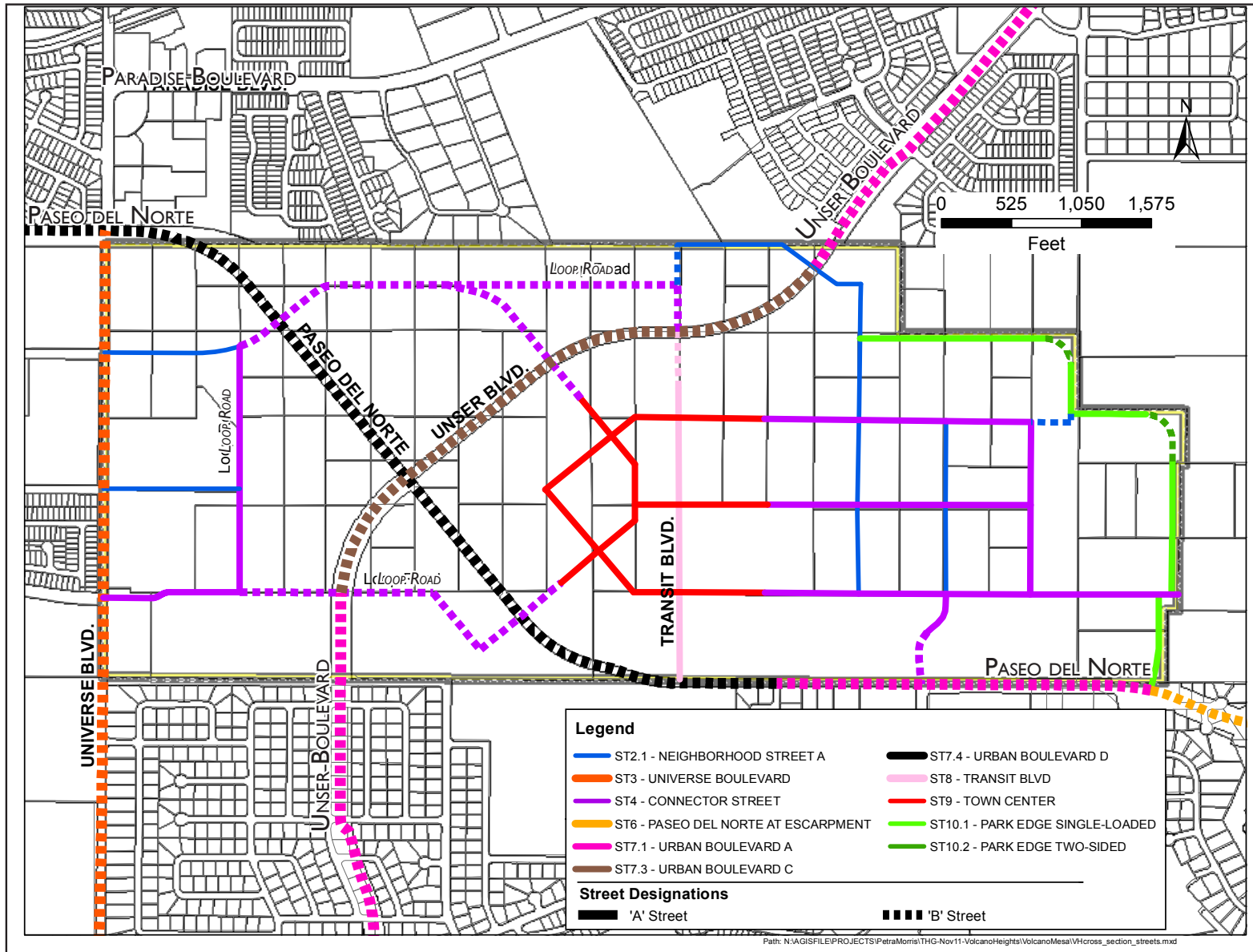

EXHIBIT 10.1 – PRIMARY STREETS AND DESIGNATIONS MAP

CHAPTER III: STREET AND STREETScape STANDARDS

10.0 STREET STANDARDS

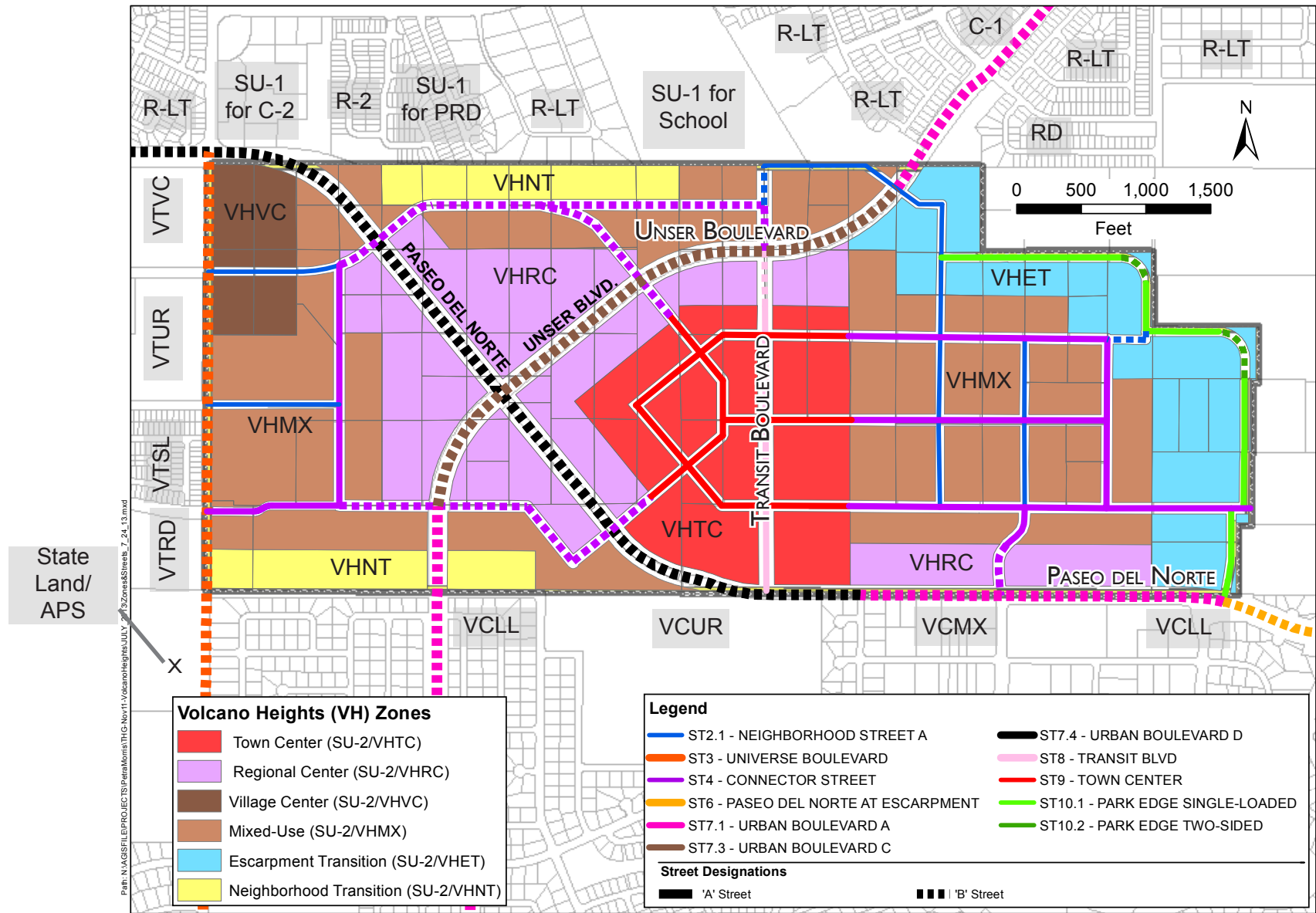

EXHIBIT 10.2 – CHARACTER ZONES AND STREET TYPES

10.3.2. **Primary Streets:** The character of streets in Volcano Heights will vary based on location. The Primary Streets and Designations Map [see **Exhibit 10.1**] illustrates the street network within the Plan area. Street alignments as shown coincide with the existing 20-foot access easement on the edge of each parcel wherever possible. **Section 10.6** starting on page 173 includes cross sections for the typical configuration of each **Primary Street** type. The specifications address vehicular lane width, parkway widths, **ROW** widths, number of travel lanes, on-street parking, and pedestrian accommodation.

- (i) Cross sections for each type of **Primary Street** depict specific elements and associated dimensions. The arrangement of these elements may change to suit local conditions, particularly when a **Primary Street** is intended for **Bus Rapid Transit (BRT)**. The final location of these lanes — whether the **BRT** will run in the median, the outside, or the inside lanes, or a combination of the above based on **adjacent** land uses, **ROW**, etc. — will be determined during the road design process. Similarly, the final location of the multi-use trail required along Paseo del Norte and Unser Boulevard will be determined in coordination with City Parks and Recreation. Trails should be situated to provide the best pedestrian access to the Town Center area. Intersections should be carefully planned and designed to facilitate connections to surrounding areas.

[Amended
November 5, 2014]

- (ii) See **Table 10.1** for allowable adjustments to the **Primary Street** standards. Adjustments should be considered carefully to ensure that the intended character of each street type is maintained or enhanced.
- (iii) See **Section 10.5.4** starting on page 172 for more on intersection design.

10.3.3. **Secondary Streets:** This Plan specifies standards for all new local streets in Volcano Heights in **Section 10.7** starting on page 199. The platting and construction of new streets will be addressed on a project-by-project basis and reviewed by the City Department of Municipal Development (DMD) the City Engineer and/or other agencies or sections, as relevant.

[Amended
November 5, 2014]

CHAPTER III: STREET AND STREETScape STANDARDS

10.0 STREET STANDARDS

TABLE 10.1 – ADJUSTMENT CRITERIA

STANDARD	MINOR ADJUSTMENT ALLOWED	CRITERIA
Location/geometry of Primary Street Alignments	Adjustment of the centerline of the street up to 300 feet. In the case of avoiding natural and/or culturally significant features, a greater allowance is permitted on a case by case basis and may require a signed agreement with adjacent owners.	<ul style="list-style-type: none"> Does not introduce a curve beyond what an automobile can navigate safely as defined in the City’s Development Process Manual (DPM) Chapter 23, Sections 2 and 3. Any deviation to the location of a Primary Street has been reviewed and approved by the Planning Director or his/her designee. Any deviations proposed to avoid rock outcroppings or other natural and/or culturally significant features has been coordinated with City Open Space Division.
Primary Street Cross Sections	Any dimensional standard change (increase or decrease) up to 20%.	<ul style="list-style-type: none"> Does not eliminate any element from a cross section. Does not decrease travel lanes below 10 feet or increase travel lanes to more than 12 feet. Has been justified by the applicant to the satisfaction of the DRB. May include criteria for variances per City Zoning Code §14-16-4-2(C).
	Adding medians to an ‘A’ Street .	<ul style="list-style-type: none"> Provides enough width to allow vegetation to be planted and sustain itself within the entire median, including turn bays.
	Adding or removing angled parking to/from an ‘A’ Street .	<ul style="list-style-type: none"> On-Street parking may be parallel or angle parking. Where angle parking is used, sufficient additional ROW is needed to add that element while still maintaining appropriate dimensions for all other elements. A median is recommended with reverse-angle parking.
	Adding or removing roundabouts and/or other traffic control device.	<ul style="list-style-type: none"> Roundabouts and/or other traffic control devices are to be constructed in compliance with all City standards with the minimal allowed profile and all feasible best practices to ensure compatibility with a high-quality pedestrian environment. Roundabouts and/or other traffic control devices on transit corridors are to be designed in coordinate with ABQ Ride. Prior to the removal of roundabouts and/or other traffic control devices on ‘A Streets,’ projects are to demonstrate alternative methods to ensure multimodal accommodations to preserve a high-quality streetscape for all transportation modes.
	Changes to the arrangement of street cross sections.	<ul style="list-style-type: none"> Has been reviewed and approved by the Planning Director or his/her designee to ensure compatibility with the intent of this Plan. Reference to ITE’s “Designing Walkable Urban Thoroughfares: A Context Sensitive Approach” or Context Sensitive Design is encouraged.
Secondary Street Cross Section	Changes to the arrangement of street cross sections.	<ul style="list-style-type: none"> Has been reviewed by the Planning Director or his/her designee to ensure compatibility with the intent of this Plan. Reference to ITE’s “Designing Walkable Urban Thoroughfares: A Context Sensitive Approach” or Context Sensitive Design is encouraged.

10.4. Access

10.4.1. **Primary Streets and Designations Map:** General access to properties is to be provided via the backbone grid of streets with general alignments and connections as shown in **Exhibit 10.1** on page 165.

10.4.2. **Intersections on Limited-Access Roads**

- (i) Unser Boulevard and Paseo del Norte are designated as limited-access facilities by the Metropolitan Planning Organization (MPO), and access is controlled via the Roadway Access Modification Policies.
- (ii) The approved intersections shown in **Exhibit 10.3** provide access to serve development in Volcano Heights and connect to surrounding areas. Intersections 1-4 are intended to create a loop road around the Paseo/Unser intersection in order to provide additional safe opportunities for all modes of travel to cross these large regional roadways expected to carry significant numbers of vehicles.
- (iii) Per the Transportation Coordinating Committee (TCC) Resolution R-13-03 [See **Appendix C**], the Paseo/Unser intersection should be reviewed for the construction of a grade-separated interchange at such time as traffic congestion and development conditions warrant.

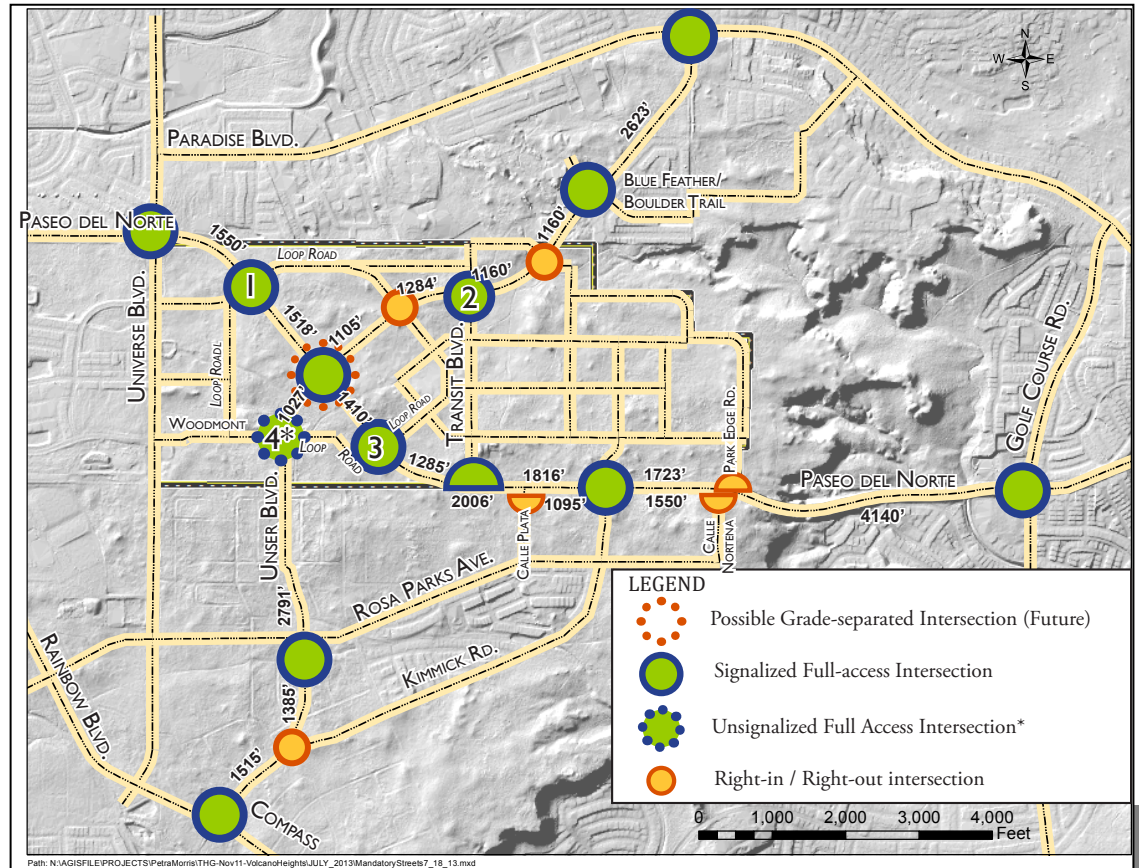

[1/4 MILE = 1320 FEET]

EXHIBIT 10.3 – APPROVED LIMITED-ACCESS INTERSECTIONS

[Amended November 5, 2014]

* NOTE: See Section 10.4.2(iii).

10.0 STREET STANDARDS

Until this time, the intersection should be constructed as a traditional at-grade, signalized intersection. At such time as a grade-separated interchange is recommended by the TCC, it should be designed to complement this urban, multimodal area and minimize negative impacts to the surrounding land uses, trails, and sensitive lands. [See also **Section 13.3.1** starting on page 229.]

- (iv) Intersection #4 is to be unsignalized until such time as Paseo del Norte/Unser Boulevard intersection becomes grade-separated, at which time #4 may be signalized.
- (v) The intersection at the southern terminus of the Transit Boulevard is approved for a “high T-intersection,” which, to the extent practical, preserves the eastbound through free-flow movement on Paseo del Norte with a dedicated eastbound to northbound left-turn lane and a southbound to eastbound left-turn lane combined with an eastbound merge lane, in order to minimize traffic signal phasing and cycle length and to minimize red-signal time for Paseo del Norte. Until such time as Paseo del Norte is constructed to a four or six lane facility and the “High-T” intersection is constructed, the intersection may be constructed as a traditional at-grade, signalized intersection.

10.4.3. Access to Properties

- (i) As envisioned in this Plan, the Primary Street grid respects the purpose of limited-access roadways as regional thoroughfares and eliminates the need for individual curb cuts for developments along these corridors. Each access point on Unser Boulevard or Paseo del Norte connects to a Primary Street to provide general access to local development. For individual developments, further access is to be provided via Secondary Streets as necessary. The planned grid provides coordinated access to properties in the Plan area and connections to Volcano Trails to the west and Volcano Cliffs to the south. Together with intersections on the limited-access roadways, planned streets in Volcano Heights create a walkable, urban district with a high degree of connectivity for all modes of transportation.
- (ii) The provision of Primary and Secondary Streets using the appropriate cross sections as shown in this Plan (See **Exhibit 10.1** on page 165) will occur via the City development review process. Streets will only be required to be constructed to serve projects at the time of their development.

- (iii) Roads are to follow the recommended Primary Street alignments where possible, as shown in **Exhibit 10.3** on page 169. Where Primary Street alignments are infeasible or unhelpful to serve new development, new street alignments should be planned to provide the most direct path between the subject property and either an existing street or approved access point along Paseo del Norte and Unser Boulevard following existing 20-foot access easements around property edges wherever possible.
- (iv) In order to allow for more rapid advancement to full development conditions, property owners are encouraged to coordinate to plan alignments and share the cost of infrastructure in whatever manner they deem fair.
- (v) Although outside the purview of this Plan, property owners should consider infrastructure financing tools (e.g. PID, TIDD, etc.) as mechanisms to pool costs and coordinate development, particularly utilities and other infrastructure to be constructed along roadway alignments.
- (vi) Sufficient documentation of coordination and agreement among all affected property owners adjacent to new streets is required prior to the issuance of permits. Sufficient documentation includes but is not limited to:
 - a. Council-approved TIDD, SAD, or PID that includes such streets and/or

- b. **DRB**-approved Site Plan for Subdivision that includes such streets as well as letter(s) of cross access easement and construction approval among affected property owners.

[See Transportation Policies in **Section 13.3** starting on page 226.]

10.5. Street Designations: The following **street designations** are established for all streets within the Plan area.

- 10.5.1. **'A' Streets:** 'A' Streets are intended to provide the most pedestrian-friendly development context. Buildings along **'A' Streets** should be held to the highest standard of **pedestrian-oriented** design. These streets are the main connectors for local development and **adjacent** neighborhoods.
 - (i) Curb cuts are not allowed on **'A' Streets**, except for porte cochere entries for hotels or other substantial uses, per the discretion of the Planning Director or his/her designee.
 - (ii) Development on **'A' Streets** may incorporate a **parking court**, surrounded on three sides by the development, served via one-way access, and with dimensions not to exceed 110 feet wide and 150 feet deep.
 - (iii) In order to provide pedestrian connectivity where blocks are more than 300 feet long, pedestrian walkways are to be provided every 300-500 feet. These walkways count toward **usable open space** requirements per **Section 9.5** starting on page 144 of this Plan.

10.0 STREET STANDARDS

- (iv) In order to support their purpose as pedestrian and cyclist-friendly corridors as well as supportive of retail and neighborhood services, **'A' Streets** are to be engineered for speeds within 5 miles per hour of posted speeds.
- (i) Additional **'A' Street** standards are included in **Section 10.6** for **Primary Streets**, as well as **Section 10.7.3** for **Secondary Streets**.

10.5.2. **'B' Streets:** 'B' Streets are intended to accommodate more **auto-oriented** uses, surface parking, and service functions. Individual standards are included in **Section 10.6.4** for Unser Boulevard, **Section 10.6.5** for Paseo del Norte, and **Section 10.7.5** for **Secondary 'B' Streets**.

- 10.5.3. **Alleys:** **Alleys** are an optional way to provide access for service and maintenance vehicles and access to parking areas for private vehicles while separating these vehicle uses from the public realm. Alleys can be either residential or commercial.
- (i) Typically narrower than **'B' Streets**, **alleys** can be a functional element within a commercial block and can provide a pleasant walking option in residential areas. [See more standards in **Sections 10.7** and **11.0 Streetscape Standards** in this Plan.]
 - (ii) See **Section 13.3.13** starting on page 236 in this Plan for policies relating to roles and responsibilities for alley maintenance.

10.5.4. **Intersection Design**

- (i) **Multimodal Accommodation:** Intersections are to designed and constructed to accommodate safe crossing for all modes of transportation.
- (ii) **Signal Warrants:** The determination of where and when traffic signals and/or roundabouts are to be installed is based upon the evaluation of traffic conditions at an intersection in accordance with the warrants contained within the Manual for Uniform Traffic Control Devices (MUTCD).
- (iii) **Development Review:** Intersection design and cross section configuration surrounding intersections shall be subject to judgment of the City Engineer and/or the Department of Municipal Development to ensure safety and appropriate connectivity.

[Amended
November 5, 2014]

- (iv) **Roundabouts:**
 - a. Excepting intersections on principal arterials, roundabouts are to be considered for every location that meets or is anticipated to meet MUTCD criteria for a traffic signal.
 - b. The criteria to be used for selecting a roundabout over other forms of intersection control such as signals or stop signs include, but are not limited to: safety, operational improvements, efficiency, traffic calming, construction and operating costs, right-of-way requirements, protection of sensitive lands, and community enhancement. [See also **Section 13.3.11** starting on page 235.]
 - c. Roundabouts are the preferred design solution when rock outcroppings lie within a Primary Street corridor as shown in **Exhibit 9.1** on page 147.
 - d. Roundabouts are to be the preferred option for intersection control on all single-lane minor arterials and collectors. They should also be considered as alternatives to signals on two-lane minor arterials.
 - e. All Traffic Impact Studies should include a comparison of the theoretical intersection delay for a roundabout versus a signal at all warranted signal locations.

- (v) **Pedestrian and/or Cyclist Activated Signals:** Safe multimodal access is key to the success of the Volcano Heights Major Activity Center. Pedestrian- and cyclist-activated signals should be considered where traffic conditions warrant in order to provide safe crossing to land uses in the area.

10.5.5. **Site Distance:** Site distance requirements shall follow current **AASHTO** standards.

10.5.6. **Americans with Disability (ADA) Compliance:** **ADA** guidelines shall govern minimum sidewalk widths to provide unobstructed passage from impedances, including but not limited to landscaping, street furniture, pedestrian amenities, utilities, signage, and grade changes.

10.6. Primary Street Cross Sections: Primary Streets are those whose alignments are shown in **Exhibit 10.1** on page 165, which also designates ‘**A**’ vs. ‘**B**’ streets. The following cross sections for each **Primary Street**, together with frontage standards for each zone per **Section 5.0** starting on page 77, are intended to create a predictable built environment along corridors, across property lines, and over time.

CHAPTER III: STREET AND STREETScape STANDARDS

10.0 STREET STANDARDS

[Amended
November 5, 2014]

TABLE 10.2 – STREET TYPES AND CROSS SECTIONS

CROSS SECTION	PROGRAMMED ROW	#VEHICULAR LANES	VEHICULAR TRAVEL LANE WIDTHS / TRANSIT LANE WIDTHS	BIKE LANE / BUFFER*	ON-STREET PARKING*	PEDESTRIAN SIDEWALK WIDTH	LANDSCAPE / TREE WELL	APPLICABLE SECTOR PLAN AREA
ST 1.1: Typical Retail Collector <i>Applicable Streets:</i> • Rosa Parks • Universe Blvd. south of Rosa Parks	58 feet	2	10 feet	None	7 feet	12 feet	(Within sidewalk width)	VCSDP
ST 1.2: Typical Residential Collector <i>Applicable Streets:</i> • Kimmick Dr.	58 feet	2	10 feet	None	7 feet	6 feet**	6 feet	VCSDP
ST 2.1: Neighborhood Street A	70 feet	2	11 feet	4 feet / 3 feet	7 feet	10 feet	(Within sidewalk width where required)	VHSDP
ST 2.2: Neighborhood Street B <i>Applicable Streets:</i> • Kimmick from Paseo to Rosa Parks • Calle Nortena from Paseo to Valiente	72 feet	2 (+ 14' median/turn bay)	10 feet	None	7 feet	6 feet	6 feet	VCSDP
ST 2.3: Neighborhood Street C <i>Applicable Street: Urraca Rd.</i>	64 feet	2	10 feet	None	7 feet	5 feet	5 feet	VCSDP

* Includes curb and gutter dimension where element is at the edge of the paved section of the roadway.

** Except where platted at 5 feet at the time of the original adoption of this Plan (May 2011), in which case the total programmed ROW is reduced by 2 feet overall.

[Amended
November 5, 2014]

TABLE 10.2 – STREET TYPES AND CROSS SECTIONS (Cont'd)

CROSS SECTION	PROGRAMMED ROW	# VEHICULAR LANES	VEHICULAR TRAVEL LANE WIDTHS / TRANSIT LANE WIDTHS	BIKE LANE / BUFFER*	ON-STREET PARKING*	PEDESTRIAN SIDEWALK WIDTH	LANDSCAPE / TREE WELL	APPLICABLE SECTOR PLAN AREA
ST 3: Universe Blvd. <i>Applicable Street: Universe Blvd.</i>	77 feet	2 (+ 16' median/center turn bay)	11 feet	5 feet	None	7 feet	5 feet	VCSDP VHSDP
ST 4: Connector Street	84 feet	2 (+ 12' median/turn bay)	10 feet	4 feet / 3 feet	7 feet	12 feet	(optional within sidewalk width)	VHSDP
ST 5: Suburban Boulevard <i>Applicable Streets:</i> • <i>Unser Boulevard at Escarpment</i> • <i>Rainbow Boulevard</i>	128 feet	4	11 feet	7 feet	None	10 feet	10 feet	VCSDP
ST 6: Paseo del Norte at Escarpment	135 feet	4 (+2 transit lanes)	11 / 12 feet	9 feet	None	(See cross section)	None	VCSDP VHSDP

* Includes curb and gutter dimension where element is at the edge of the paved section of the roadway.

CHAPTER III: STREET AND STREETScape STANDARDS

10.0 STREET STANDARDS

[Amended
November 5, 2014]

TABLE 10.2 – STREET TYPES AND CROSS SECTIONS (Cont'd)

CROSS SECTION	PROGRAMMED ROW	#VEHICULAR LANES	VEHICULAR TRAVEL LANE WIDTHS / TRANSIT LANE WIDTHS	BIKE LANE / BUFFER*	ON-STREET PARKING*	PEDESTRIAN SIDEWALK WIDTH	LANDSCAPE / TREE WELL	APPLICABLE SECTOR PLAN AREA
ST 7.1: Urban Boulevard A <i>Applicable Streets:</i> <ul style="list-style-type: none"> • Paseo del Norte from Calle Nortena to Kimmick • Unser Boulevard from southern boundary of Volcano Cliffs to Escarpment • Unser Boulevard from Kimmick to Woodmont 	156 feet	4 (+ 50' median)	11 feet	6 feet	None	10 feet	10 feet	VCSDP
ST 7.2: Urban Boulevard B <i>Applicable Streets:</i> <ul style="list-style-type: none"> • Unser Boulevard from Escarpment to Kimmick 	156 feet	4 (+36' median)	12 feet	8 feet	None	None	None	VCSDP
ST 7.3: Urban Boulevard C <i>Applicable Streets:</i> <ul style="list-style-type: none"> • Unser Boulevard from Woodmont to northernmost right-in/right-out in Volcano Heights 	156 feet	4 (+2 slip lanes)	11 / 12 feet	4 feet / 2 feet	None	(See cross section)	(See cross section)	VHSDP
ST 7.4: Urban Boulevard D <i>Applicable Street: Paseo del Norte from Kimmick to western boundary of Volcano Trails</i>	156 feet	6 (+2 transit lanes)	11 / 12 feet	6 feet / 2 feet	None	10 feet	(Within sidewalk width)	VHSDP VTSDP

* Includes curb and gutter dimension where element is at the edge of the paved section of the roadway.

[Amended
November 5, 2014]

TABLE 10.2 – STREET TYPES AND CROSS SECTIONS (Cont'd)

CROSS SECTION	PROGRAMMED ROW	# VEHICULAR LANES	VEHICULAR TRAVEL LANE WIDTHS / TRANSIT LANE WIDTHS	BIKE LANE / BUFFER*	ON-STREET PARKING*	PEDESTRIAN SIDEWALK WIDTH	LANDSCAPE / TREE WELL	APPLICABLE SECTOR PLAN AREA
ST 8: Transit Boulevard	120 feet	2 (+2 transit lanes)	10 / 12 feet	4 feet / 3 feet	7 feet	12 feet	6 feet	VHSDP
ST 9: Town Center	96 feet	2	11 feet	4 feet / 3 feet	18 feet (reverse-angle)	12 feet	(Within sidewalk width)	VHSDP
ST 10.1: Park Edge – Single-loaded	76 feet	2 (+12' median/turn bay)	11 feet	6.5 feet / 2.5 feet	7 feet (one side only)	10 feet	(Within sidewalk width)	VHSDP
ST 10.2: Park Edge – Double-loaded	70 feet	2	11 feet	4 feet / 3 feet	7 feet	10 feet	(Within sidewalk width)	VHSDP
ST 11: Local Street	52 feet	2	9 feet	None	6 feet	6 feet**	5 feet	VCSDP

* Includes curb and gutter dimension where element is at the edge of the paved section of the roadway.

CHAPTER III: STREET AND STREETScape STANDARDS

10.0 STREET STANDARDS

[Note: Street Types 1.1 and 1.2 are not used within the Volcano Heights SDP]

[Amended November 5, 2014]

ST 1.1: RETAIL COLLECTOR

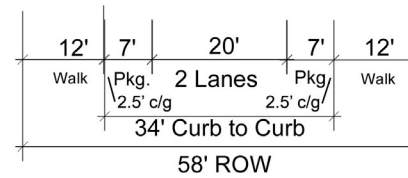

STREET TYPE 1.1 – TYPICAL RETAIL COLLECTOR (2 LANES)

* Note: c/g stands for “curb and gutter”

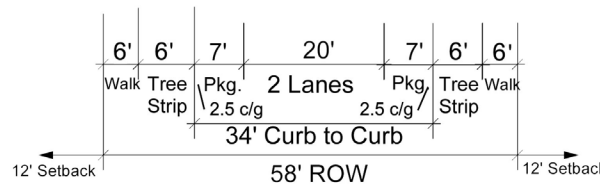
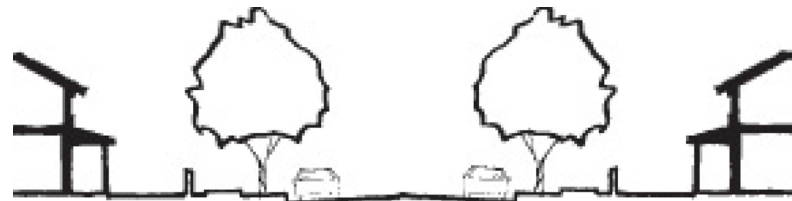

STREET TYPE 1.2 – TYPICAL RESIDENTIAL COLLECTOR (2 LANES)

- 10.6.1. **Street Type 2.1:** Neighborhood Street A
- (i) **Intent/Purpose:** These streets are intended to access local uses, predominantly businesses and residences within the Plan area.
 - (ii) **Cross Section:** See **Exhibit 10.4.**
 - (iii) **Frontage Standards:** See Site Development Standards in **Section 5** starting on page 77.
 - (iv) **Streetscape Standards:** See **Section 11** starting on page 205.

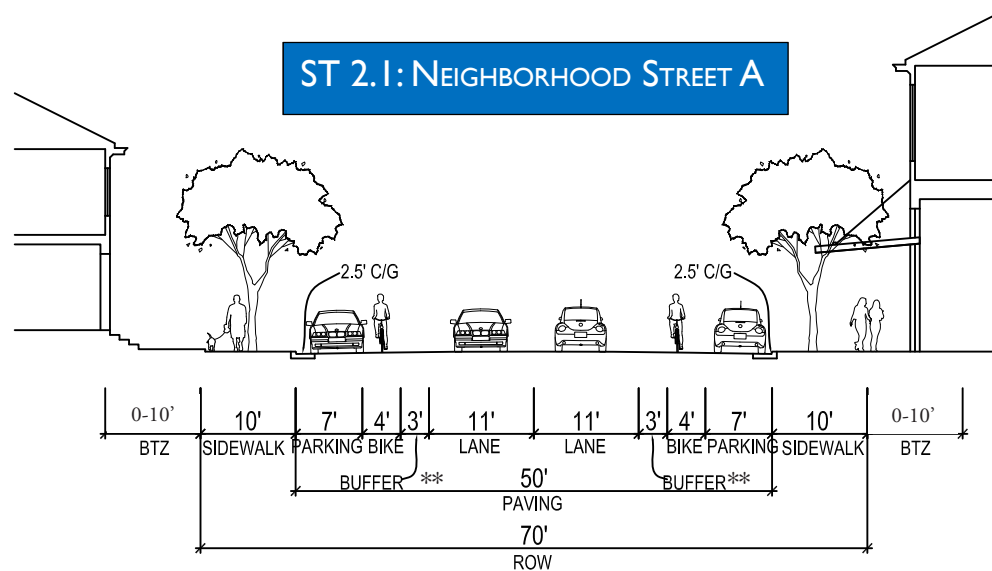

[Amended November 5, 2014]

EXHIBIT 10.4 – STREET TYPE 2.1: NEIGHBORHOOD STREET A

* Note: C/G = Curb and Gutter

** Note: Buffer = Separation between the bicycle and vehicle lanes.

CHAPTER III: STREET AND STREETScape STANDARDS

10.0 STREET STANDARDS

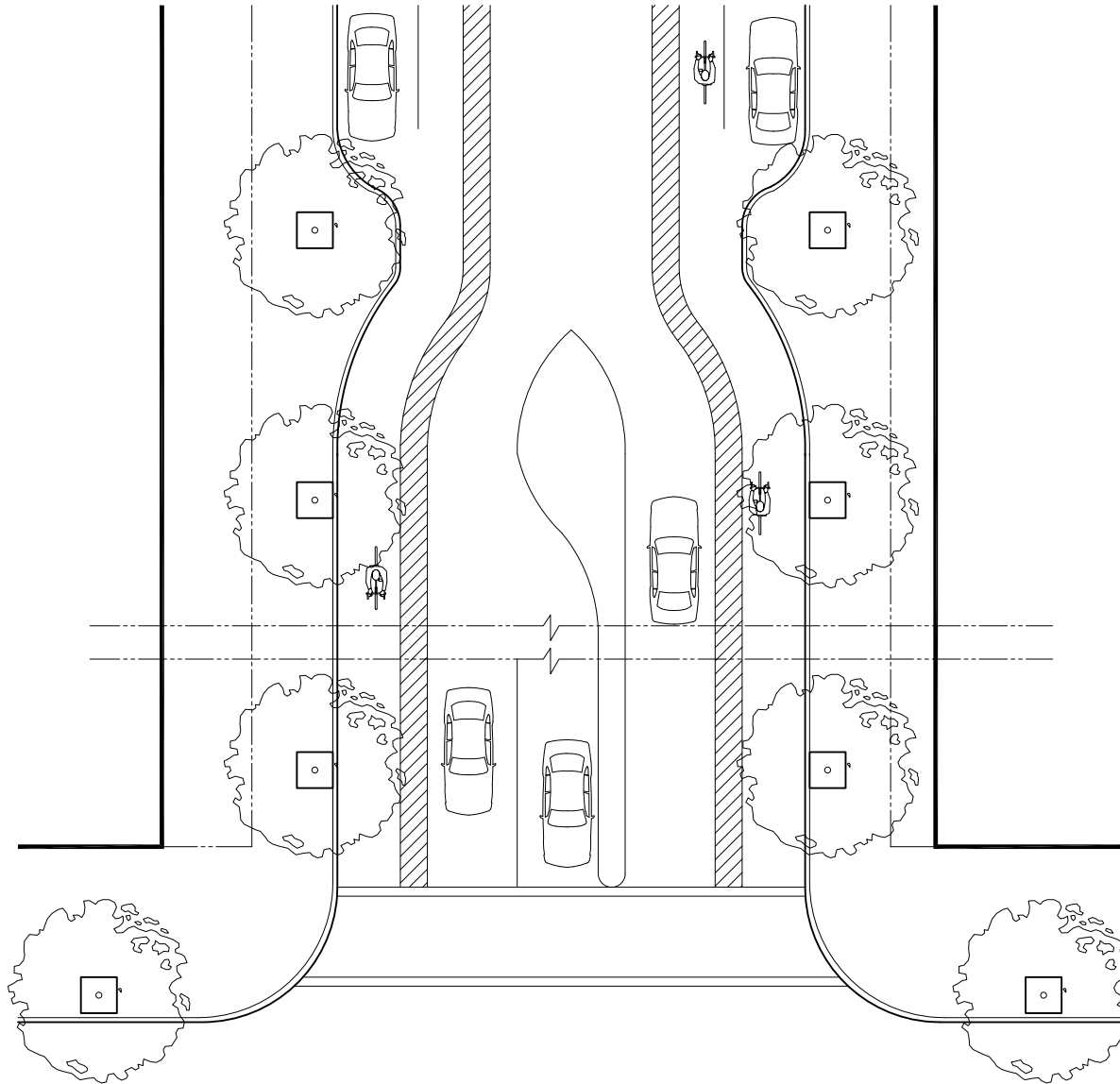

EXHIBIT 10.5 – STREET TYPE 2.1: NEIGHBORHOOD STREET A – TYPICAL INTERSECTION (PLAN VIEW)

[Note: Street Types 2.2 and 2.3 are not used within the Volcano Heights SDP]

ST 2.2: NEIGHBORHOOD STREET B

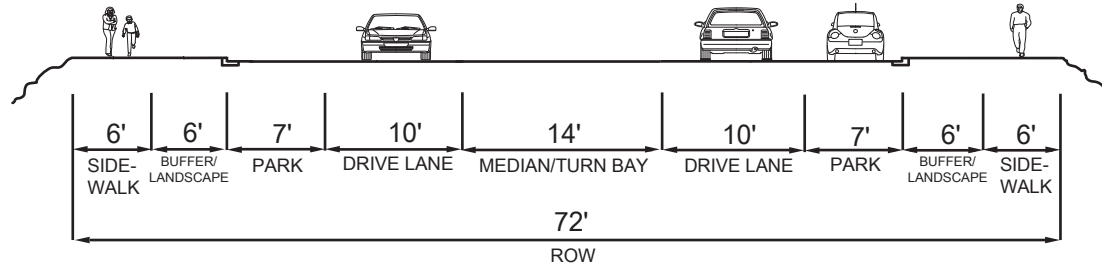

EXHIBIT 10.6 – STREET TYPE 2.2: NEIGHBORHOOD STREET B

ST 2.3: NEIGHBORHOOD STREET C

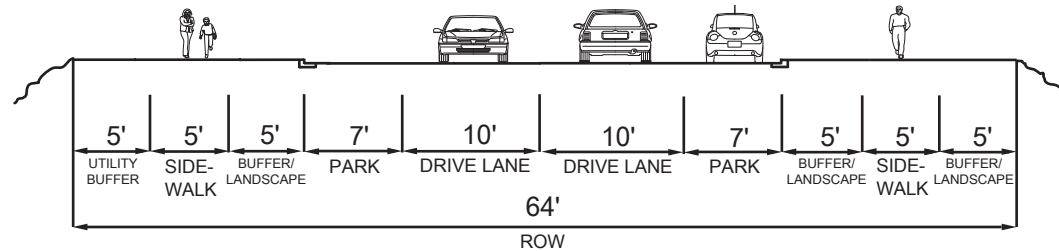

EXHIBIT 10.7 – STREET TYPE 2.3: NEIGHBORHOOD STREET C

[Amended November 5, 2014]

CHAPTER III: STREET AND STREETScape STANDARDS

10.0 STREET STANDARDS

[Amended November 5, 2014]

- 10.6.2. **Street Type 3:** Universe Blvd.
- (i) **Intent/Purpose:** Universe Boulevard is a minor arterial carrying significant traffic volumes to facilitate regional movement. At the same time, it connects many predominantly residential areas and therefore must be safe and comfortable for pedestrian and cyclists.
 - (ii) **Cross Section:** See **Exhibit 10.18.**
 - (iii) **Frontage Standards:** See Site Development Standards in **Section 5** starting on page 77.
 - (iv) **Streetscape Standards:** See **Section 11** starting on page 205.

ST 3: UNIVERSE BLVD.

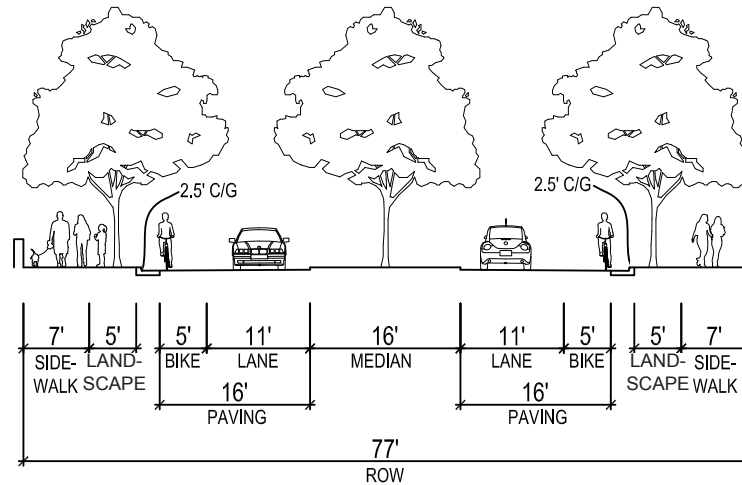
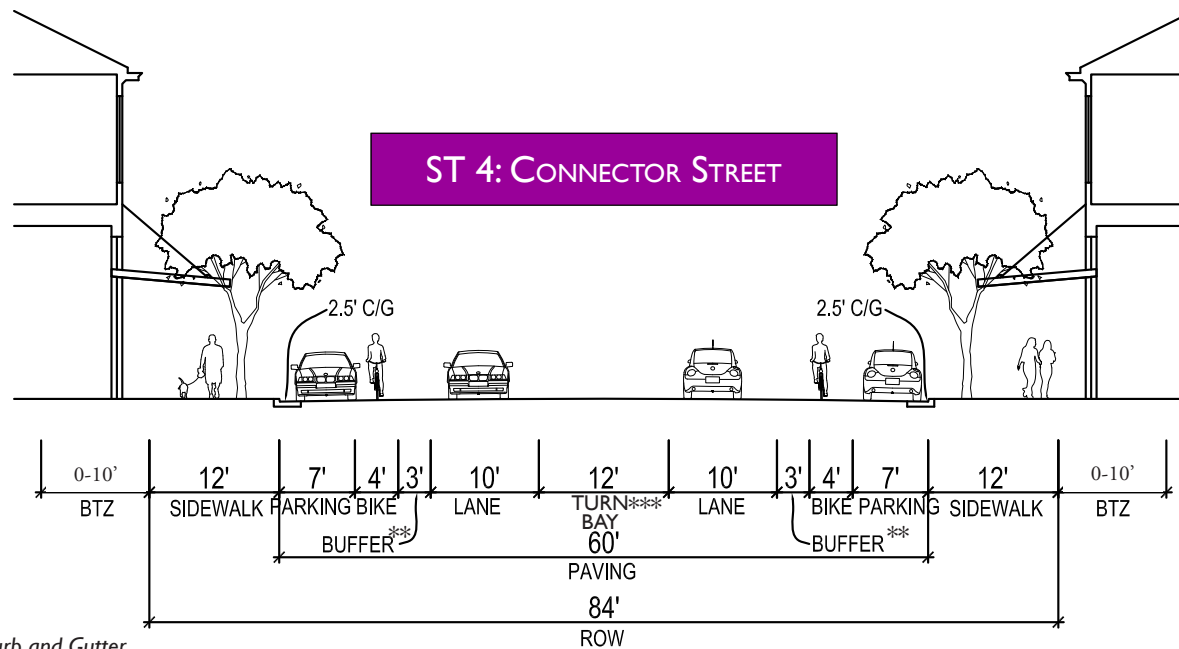

EXHIBIT 10.8 – STREET TYPE 3: UNIVERSE BLVD.

10.6.3. **Street Type 4: Connector Street**

- (i) **Intent/Purpose:** These streets are intended to access **neighborhood streets** and promote multi-modal transportation to reach businesses and residences within the Plan area.
- (ii) **Cross Section:** See **Exhibit 10.6.**
- (iii) **Frontage Standards:** See Site Development Standards in **Section 5** starting on page 77.
- (iv) **Streetscape Standards:** See **Section 11** starting on page 205.

[Amended November 5, 2014]



* Note: C/G = Curb and Gutter

** Note: Buffer = Separation between the bicycle and vehicle lanes.

*** Note: The center lane is a two-way left-turning lane and/or median as appropriate.

EXHIBIT 10.9 – STREET TYPE 4: CONNECTOR STREET

10.0 STREET STANDARDS

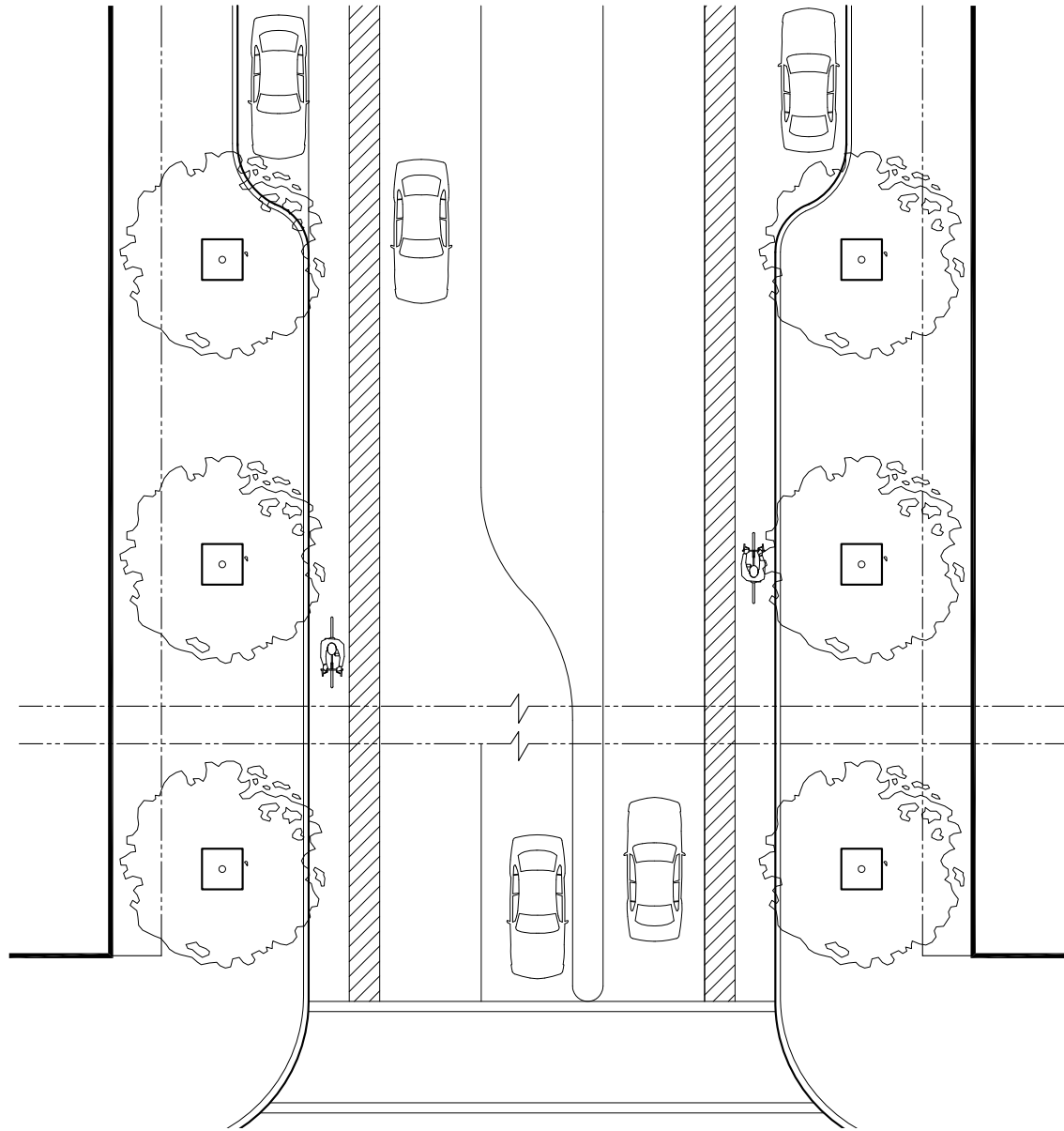

EXHIBIT 10.10 – STREET TYPE 4: CONNECTOR STREET – TYPICAL INTERSECTION (PLAN VIEW)

10.0 STREET STANDARDS

[Note: Street Type 5 is not used within the Volcano Heights SDP]

[Amended November 5, 2014]

ST 5: SUBURBAN BOULEVARD

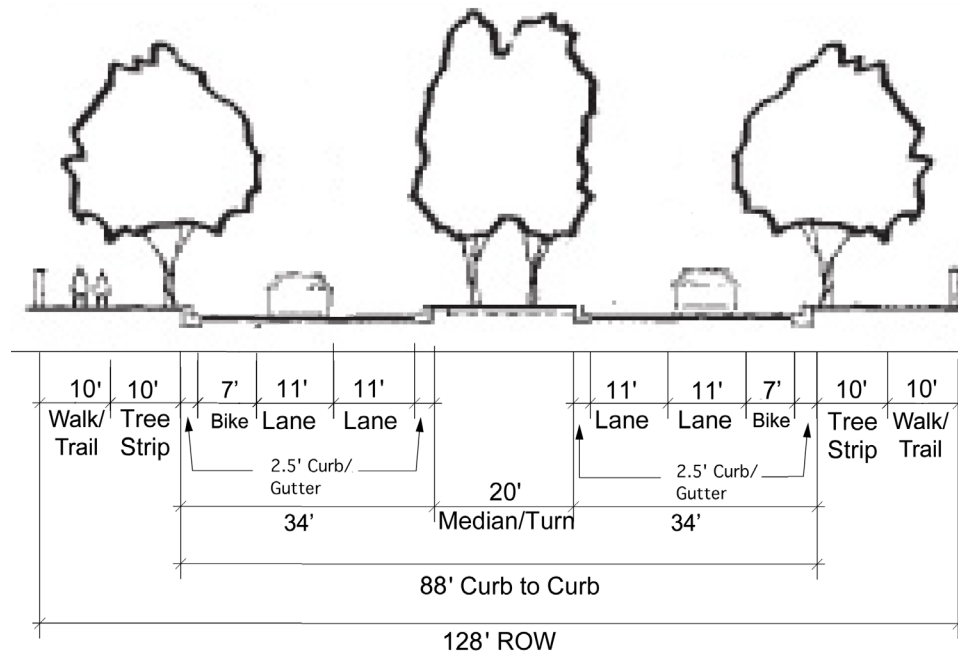

EXHIBIT 10.11 – STREET TYPE 5: SUBURBAN BOULEVARD

CHAPTER III: STREET AND STREETScape STANDARDS

10.0 STREET STANDARDS

[Note: Street Type 6 is not used within the Volcano Heights SDP]

[Amended November 5, 2014]

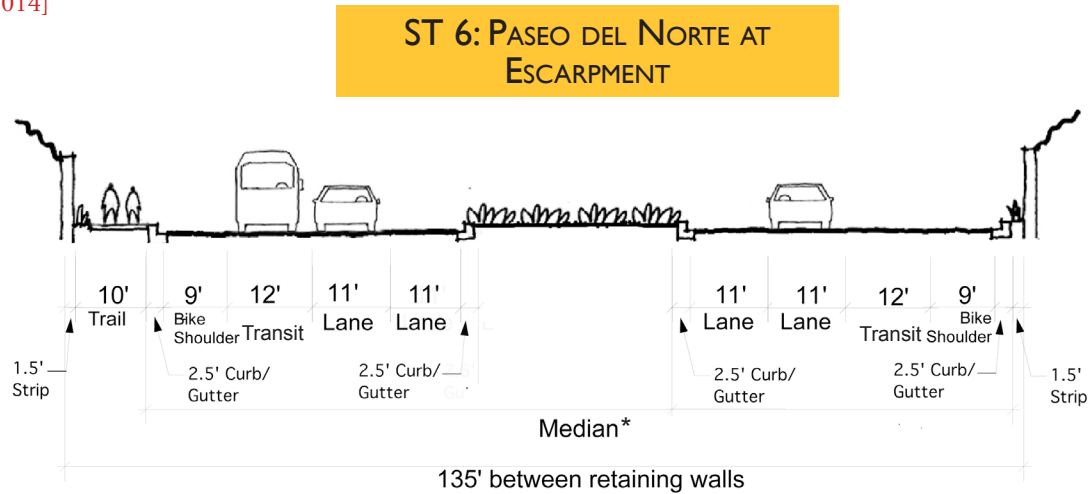

* Note: Median width varies according to right-of way through the Petroglyph National Monument

EXHIBIT 10.12 – STREET TYPE 6: PASEO DEL NORTE AT ESCARPMENT (6 LANES WITH TRANSIT)

[Amended November 5, 2014]

ST 7.1: URBAN BOULEVARD A

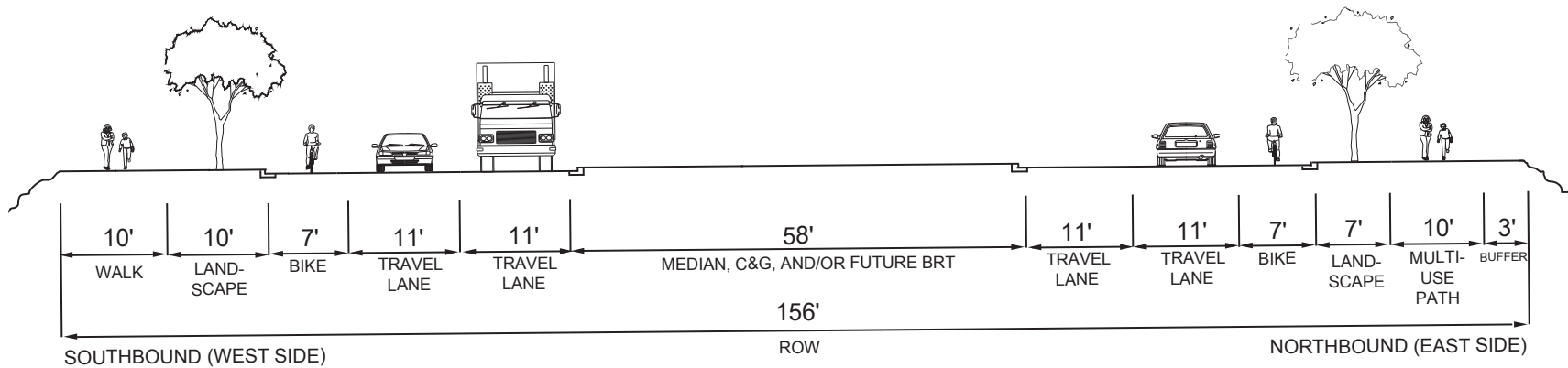

* Note: C/G = Curb and Gutter

** Note: Buffer = Separation between the multi-use path and private ROW.

EXHIBIT 10.13 – STREET TYPE 7.1: URBAN BOULEVARD A

10.0 STREET STANDARDS

[Note: Street Type 7.2 is not used within the Volcano Heights SDP]

[Amended November 5, 2014]

ST 7.2: URBAN BOULEVARD B

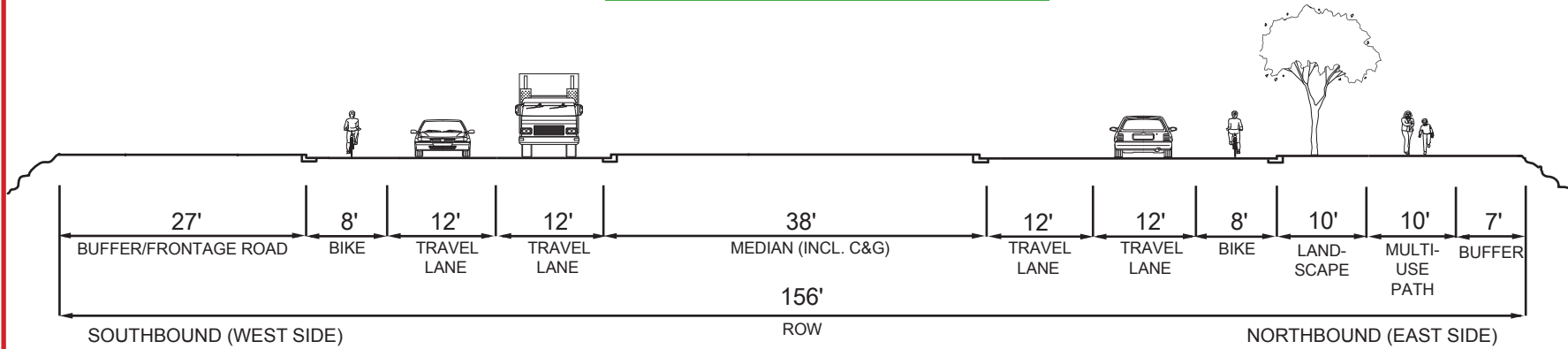
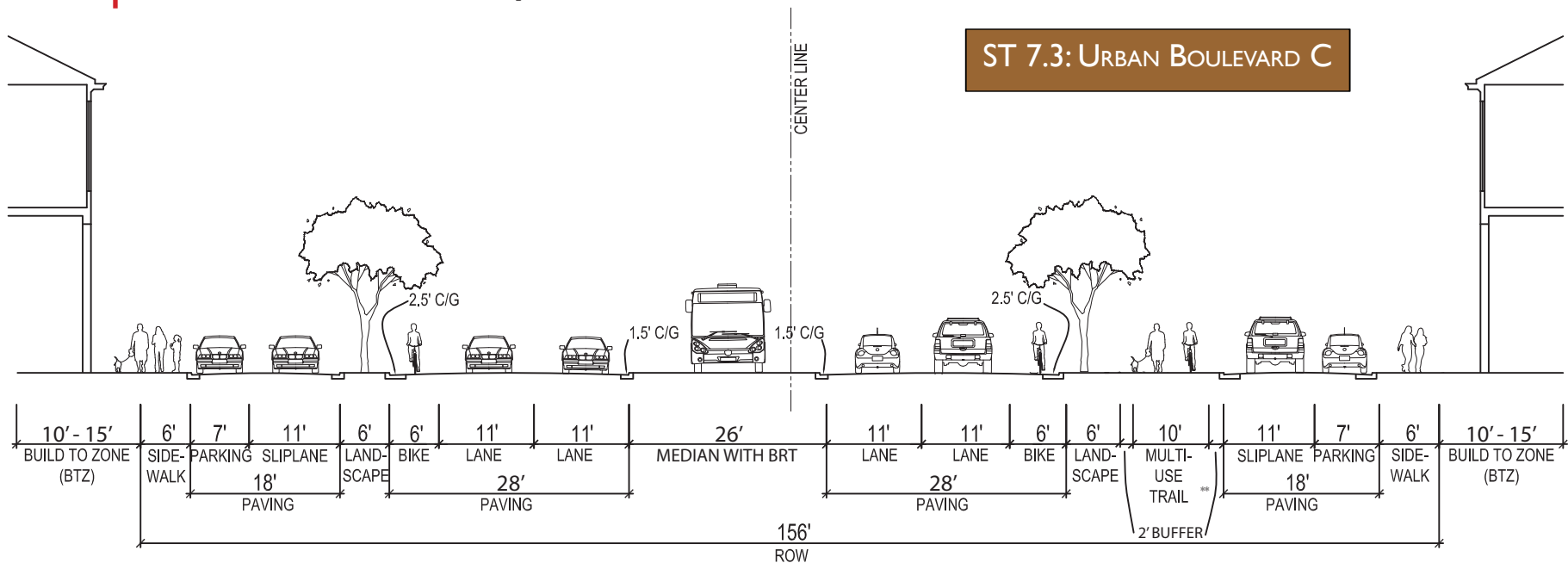

EXHIBIT 10.14 – STREET TYPE 7.2 – URBAN BOULEVARD B

- 10.6.4. **Street Type 7.3:** Urban Boulevard C
- (i) **Intent/Purpose:** Unser Boulevard is primarily a regional road, serving residents and businesses within Volcano Heights as well as the surrounding region.
 - (ii) **Cross Section**
 - a. See **Exhibit 10.16.**
 - b. Slip lanes are for one-way movement only. Directional signage is needed.
 - c. Beginning 500 feet from an intersection with Paseo del Norte, the Transit Boulevard, or any potential station locations, an extra 24 feet in the ROW may be needed for **BRT** lanes and/or station platforms.

[Amended
November 5, 2014]

- (iii) **Frontage Standards:** See Site Development Standards in **Section 5** starting on page 77.
- (iv) **Streetscape Standards:** See **Section 11** starting on page 205.



* Note: C/G = Curb and Gutter
 ** Note: Multi-use trail to be southeast of Unser Blvd. between Woodmont and Transit Blvd. and northwest of Unser Blvd. between Transit Blvd. and the northern edge of the Plan area.

EXHIBIT 10.15 – STREET TYPE 7.3: URBAN BOULEVARD C

10.0 STREET STANDARDS

- 10.6.5. **Street Type 7.4: Urban Boulevard D**
- (i) **Intent/Purpose:** Paseo del Norte is primarily a regional road, serving residents and businesses within Volcano Heights as well as the surrounding region.

- (ii) **Cross Section**
- See **Exhibit 10.17**.
 - Beginning 500 feet from an intersection with Unser Boulevard, the Transit Boulevard, or any potential station locations, 24 feet in the **ROW** may be needed for **BRT** lanes and/or station platforms.
- (iii) **Frontage Standards:** See Site Development Standards in **Section 5** starting on page 77.
- (iv) **Streetscape Standards:** See **Section 11** starting on page 205.

[Amended
November 5, 2014]

ST 7.4: URBAN BOULEVARD D

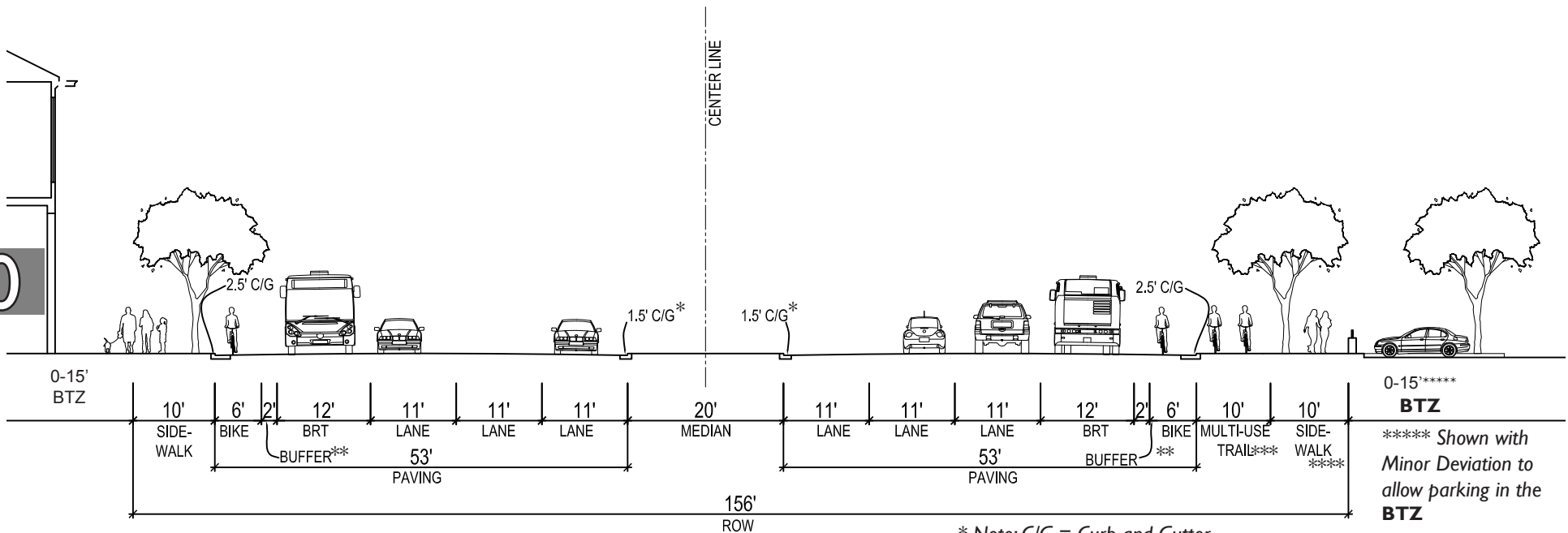

EXHIBIT 10.16 – STREET TYPE 7.4: URBAN BOULEVARD D

* Note: C/G = Curb and Gutter
 ** Note: Buffer = Separation between the bicycle and vehicle lanes.
 *** Note: Multi-use trail to be on the east side of Paseo del Norte.
 **** Note: Sidewalk dimension may be adjusted to accommodate trail and/or trail buffer.

10.6.6. **Street Type 8: Transit Boulevard**

(i) **Intent/Purpose:** The Transit Boulevard serves multiple modes of transportation, including the proposed **BRT**. The walkable, dense, urban Town Center is organized around this Transit Boulevard, which acts as a “Main Street” for Volcano Heights.

(ii) **Cross Section**

- a. See **Exhibit 10.14**.
- b. Beginning 500 feet from intersections on Paseo del Norte, Unser Boulevard, and any other potential station locations, an extra 36 feet of ROW may be needed for **BRT** lanes and/or station platforms.

(iii) **Frontage Standards:** See Site Development Standards in **Section 5** starting on page 77.

(iv) **Streetscape Standards:** See **Section 11** starting on page 205.

[Amended
November 5, 2014]

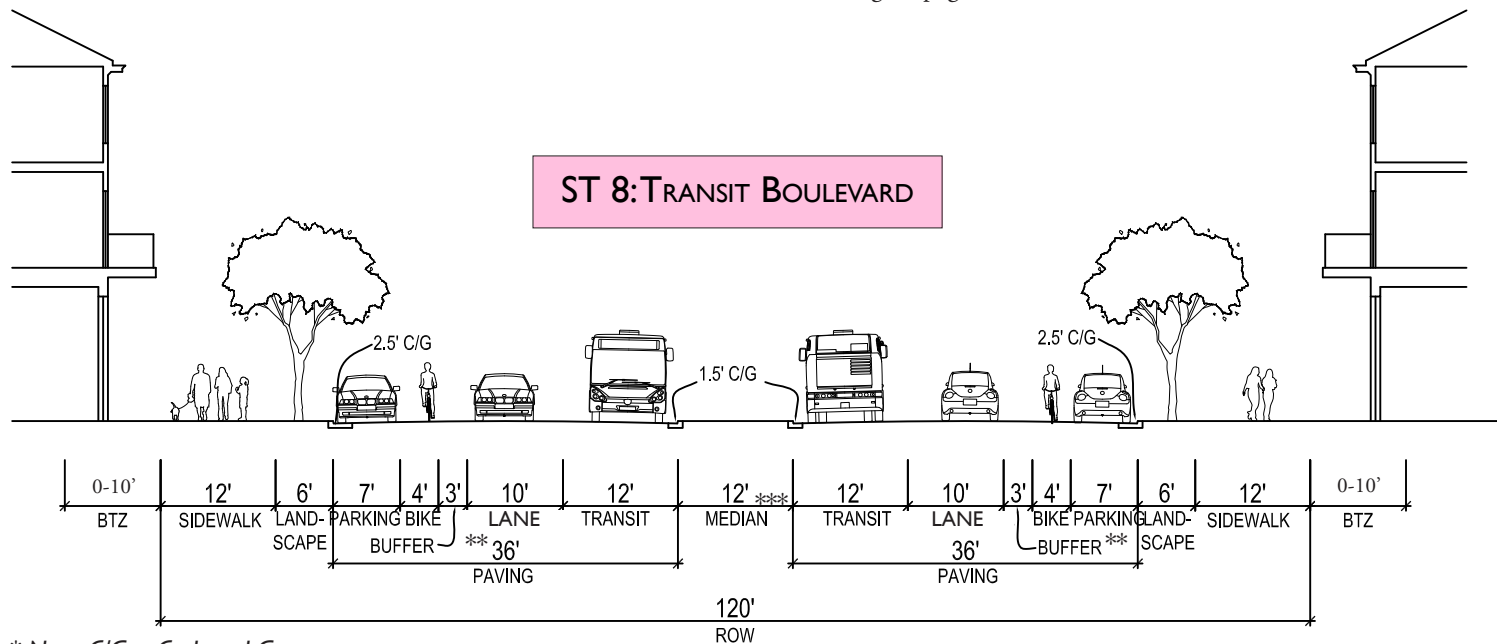

* Note: C/G = Curb and Gutter

** Note: Buffer = Separation between the bicycle and vehicle lanes.

*** Note: Median becomes Turn Bay or equivalent in ‘B’ Street segments.

EXHIBIT 10.17 – STREET TYPE 8: TRANSIT BOULEVARD

10.0 STREET STANDARDS

ST 8: TRANSIT BOULEVARD

10

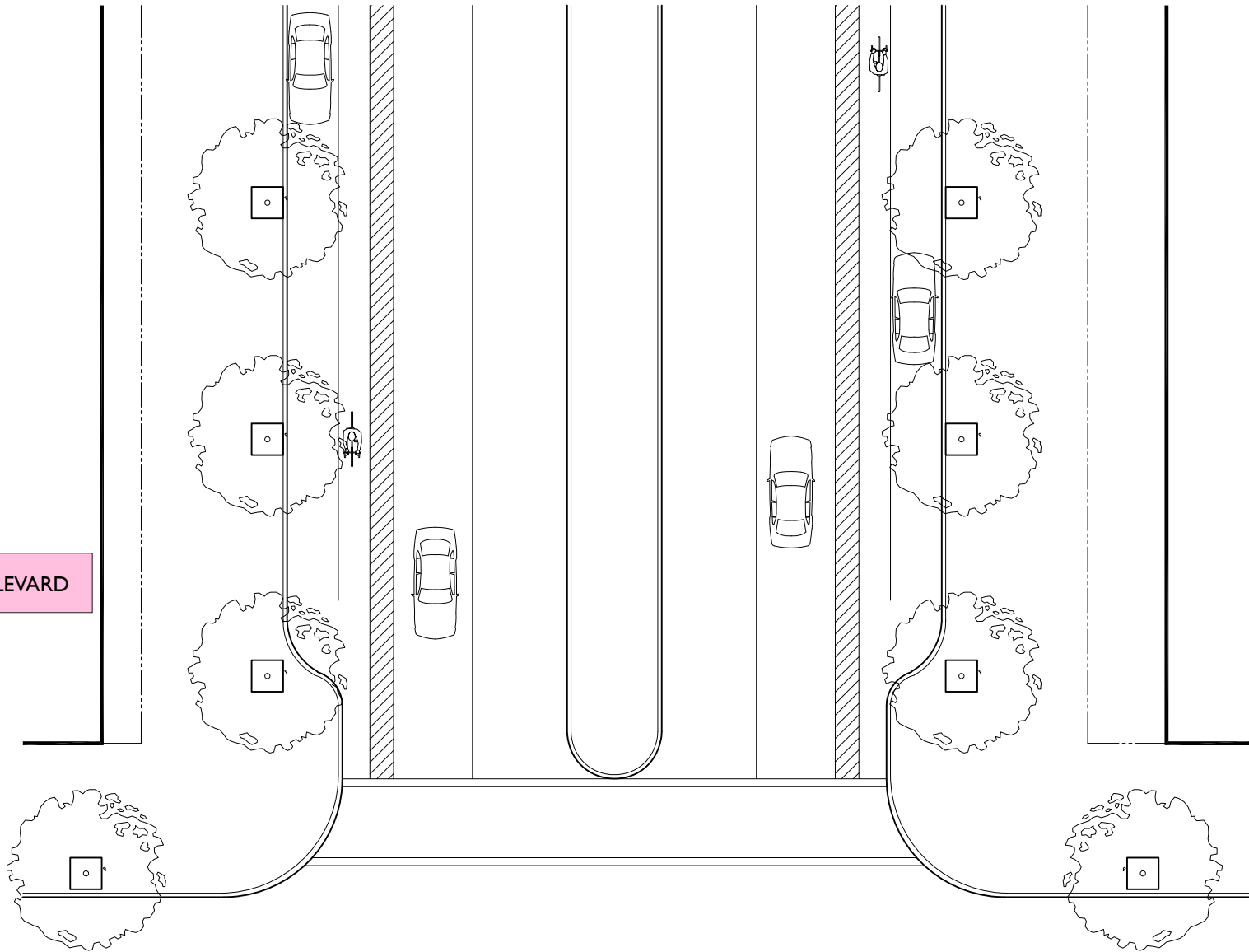

EXHIBIT 10.18 – STREET TYPE 8: TYPICAL INTERSECTION (PLAN VIEW)

10.6.7. **Street Type 9: Town Center Street**

- (i) **Intent/Purpose:** These streets are intended to be the most pedestrian-friendly while supporting multiple modes of transportation circulating throughout the Plan area and surrounding region.
- (ii) **Cross Section:** See **Exhibit 10.4.**
- (iii) **Frontage Standards:** See Site Development Standards in **Section 5.1** starting on page 78.
- (iv) **Streetscape Standards:** See **Section 11** starting on page 205.

[Amended
November 5, 2014]

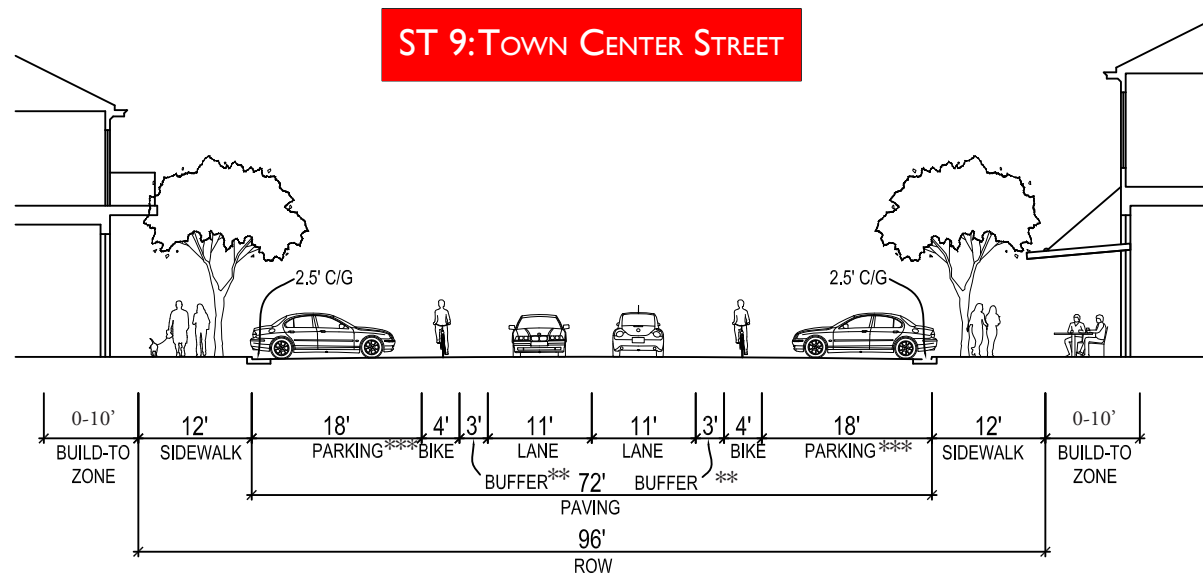

EXHIBIT 10.19 – STREET TYPE 9: TOWN CENTER STREET

* Note: C/G = Curb and Gutter

** Note: Buffer = Separation between the bicycle and vehicle lanes.

*** Note: Parking shown is reverse-angle parking. See **Section 13.3.10(ix)**.

10.0 STREET STANDARDS

ST 9: TOWN CENTER STREET

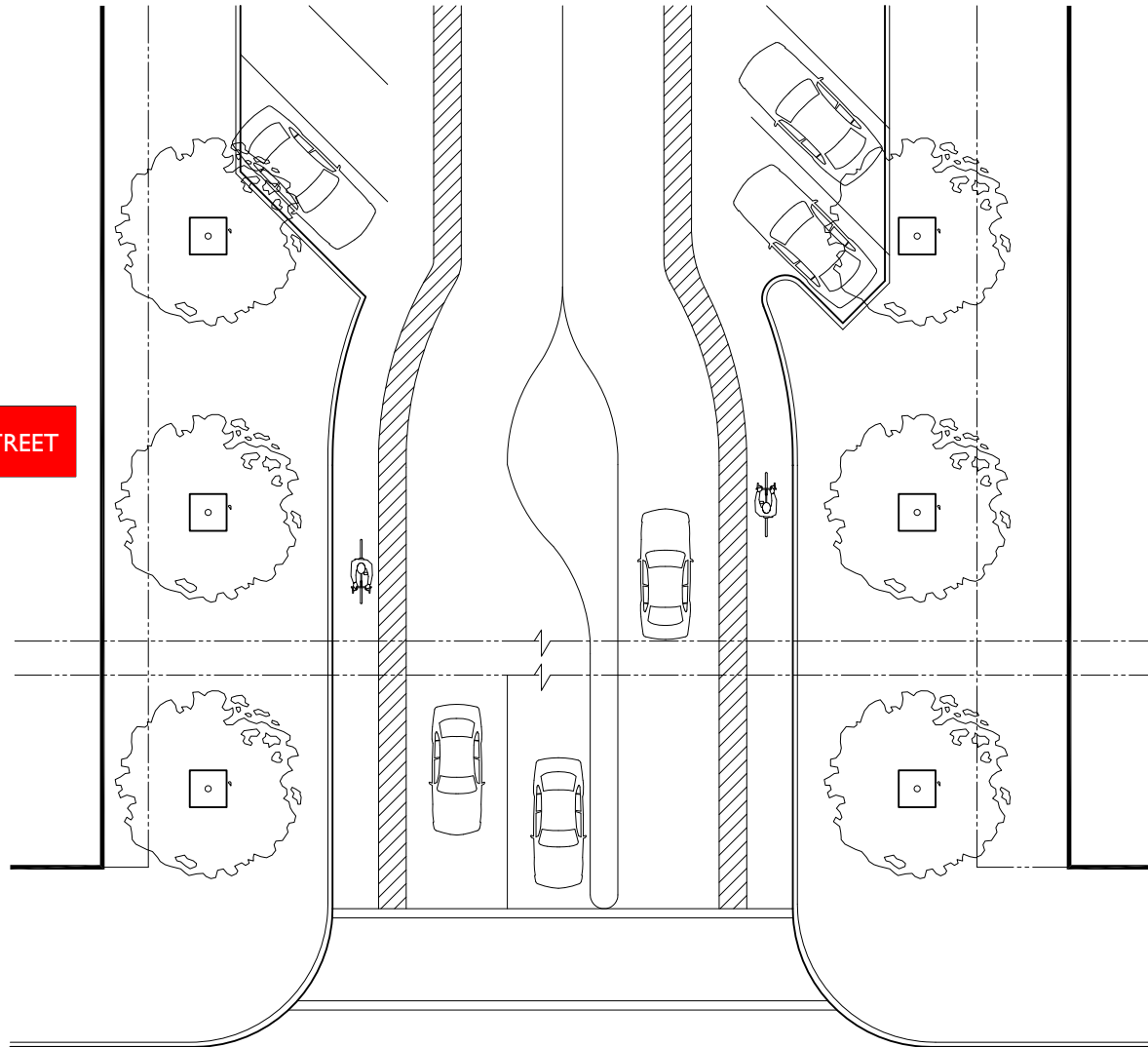
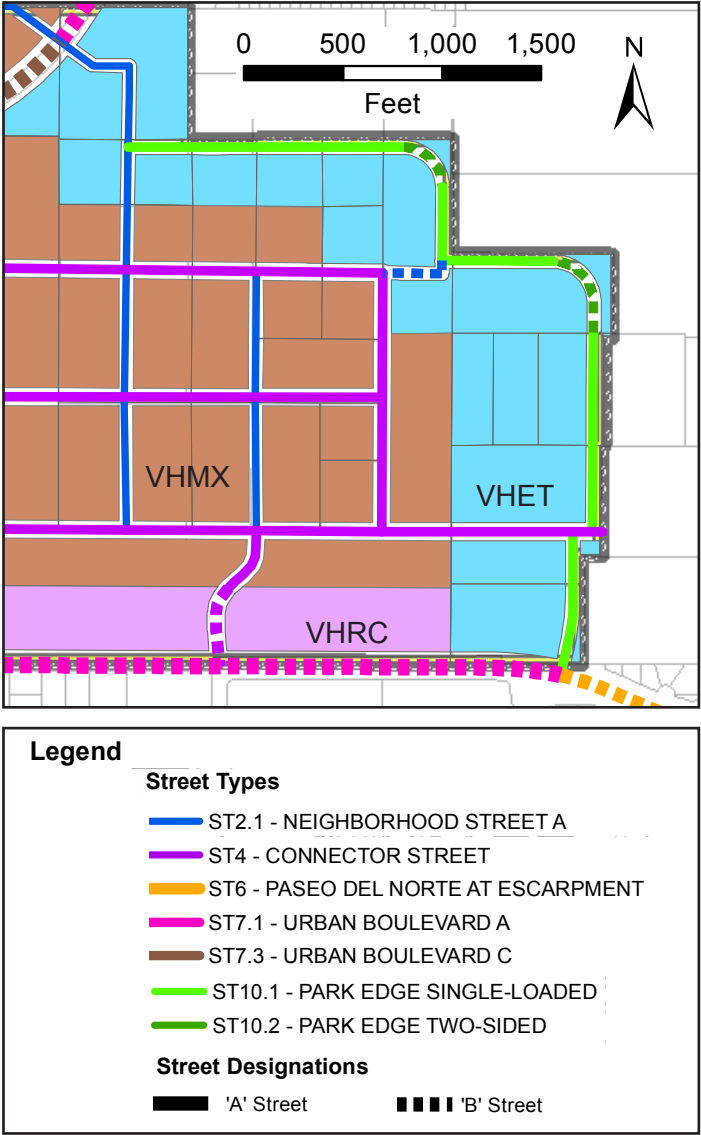

EXHIBIT 10.20 – STREET TYPE 9: TYPICAL INTERSECTION (PLAN VIEW)

10.6.8. Street Type 10: Park Edge

- (i) **Intent/Purpose:** The Park Edge road is intended to access local development, predominantly residences and businesses within the Plan area, by multiple modes of transportation, including on-street bicycle lanes as well as connections to an off-street trail along the Petroglyph National Monument. **Major Public Open Space** is best enhanced and protected as a public amenity when buffered from development by a **single-loaded road** along Major Public Open Space edges (i.e. development only occurs on the side of the road farthest from the Major Public Open Space). The City Open Space Division and the National Park Service prefer the single-loaded road as the best transition between development and sensitive lands within the Petroglyph National Monument. Single-loaded roads increase safety for open space users and nearby property owners by providing visibility for surveillance and monitoring, as well as improving accessibility for park users. Single-loaded roads are also the most effective means of protecting important views into and out of the Monument, as well as to the Sandia Mountains to the east. The Park Edge road cross sections are designed to incorporate landscaping and medians that act as transitions from the built environment to **sensitive lands** within the Monument.



DETAIL OF EXHIBIT 10.2 – CHARACTER ZONES AND STREET TYPES: PARK EDGE ROAD

10.0 STREET STANDARDS

[Amended November 5, 2014]

ST 10.1: PARK EDGE SINGLE-LOADED

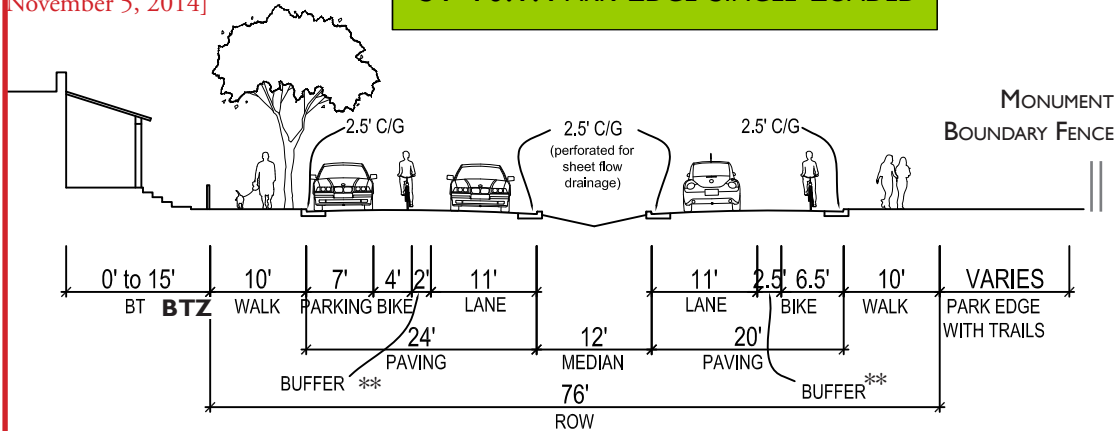

* Note: C/G = Curb and Gutter
 ** Note: Buffer = Separation between the bicycle and vehicle lanes.

EXHIBIT 10.21 – STREET TYPE 10.1: PARK EDGE SINGLE-LOADED

ST 10.2: PARK EDGE TWO-SIDED

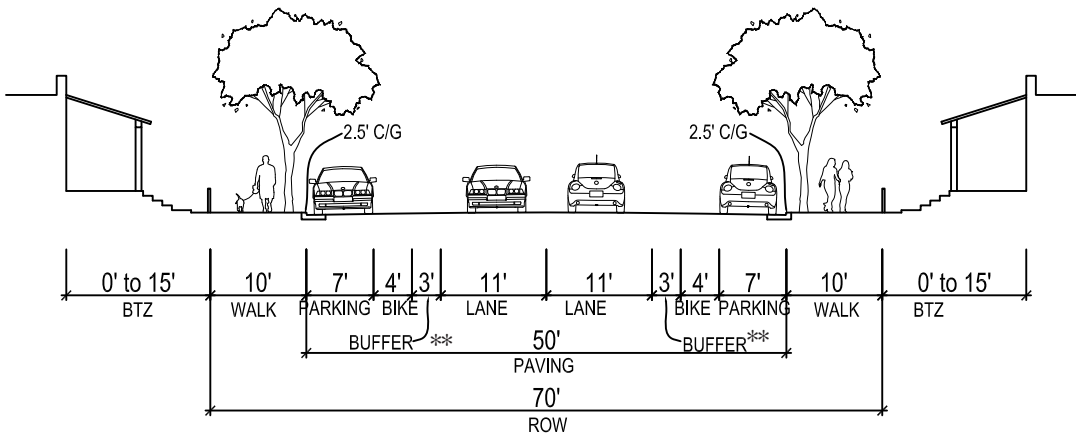

* Note: C/G = Curb and Gutter
 ** Note: Buffer = Separation between the bicycle and vehicle lanes.

EXHIBIT 10.22 – STREET TYPE 10.2: PARK EDGE DOUBLE-LOADED

- (ii) **Cross Sections:** Two cross sections are provided for the Park Edge Street.
 - a. Where the street abuts the Petroglyph National Monument and/or where development is only intended on the west side of the road, Street Type 4.1 is to be constructed. [See **Exhibit 10.10.**]
 - b. Where development will occur on both sides of the street, Street Type 4.2 is to be used. [See **Exhibit 10.11.**]
 - c. The Park Edge and additional east-west streets in the SU-2 Volcano Heights Escarpment Transition (VHET) zone should ~~shall~~ be sited to provide pedestrian access to the Petroglyph National Monument. Access shall be determined by the National Park Service Monument Visitor Plan and/or by the City Open Space Division in lieu thereof.
 - d. Where a median is incorporated, it should be perforated for hydrology and rainwater drainage and control, subject to approval by the City Hydrologist.
- (iii) **Frontage Standards:** See Site Development Standards in **Section 5** starting on page 77.
- (iv) **Streetscape Standards:** See **Section 11** starting on page 205.

- (v) **Linear pond/bioswale:** The median and/or eastern edge of the Park Edge Road is an appropriate and beneficial location for a bioswale/linear pond. Such a pond, designed in consultation with the City Engineer can help to meet the City's water quality goals. [See also **Goal 12.5.5** starting on page 222 and **Policy 13.5.3** starting on page 242.]

ST 10.1: PARK EDGE SINGLE-LOADED

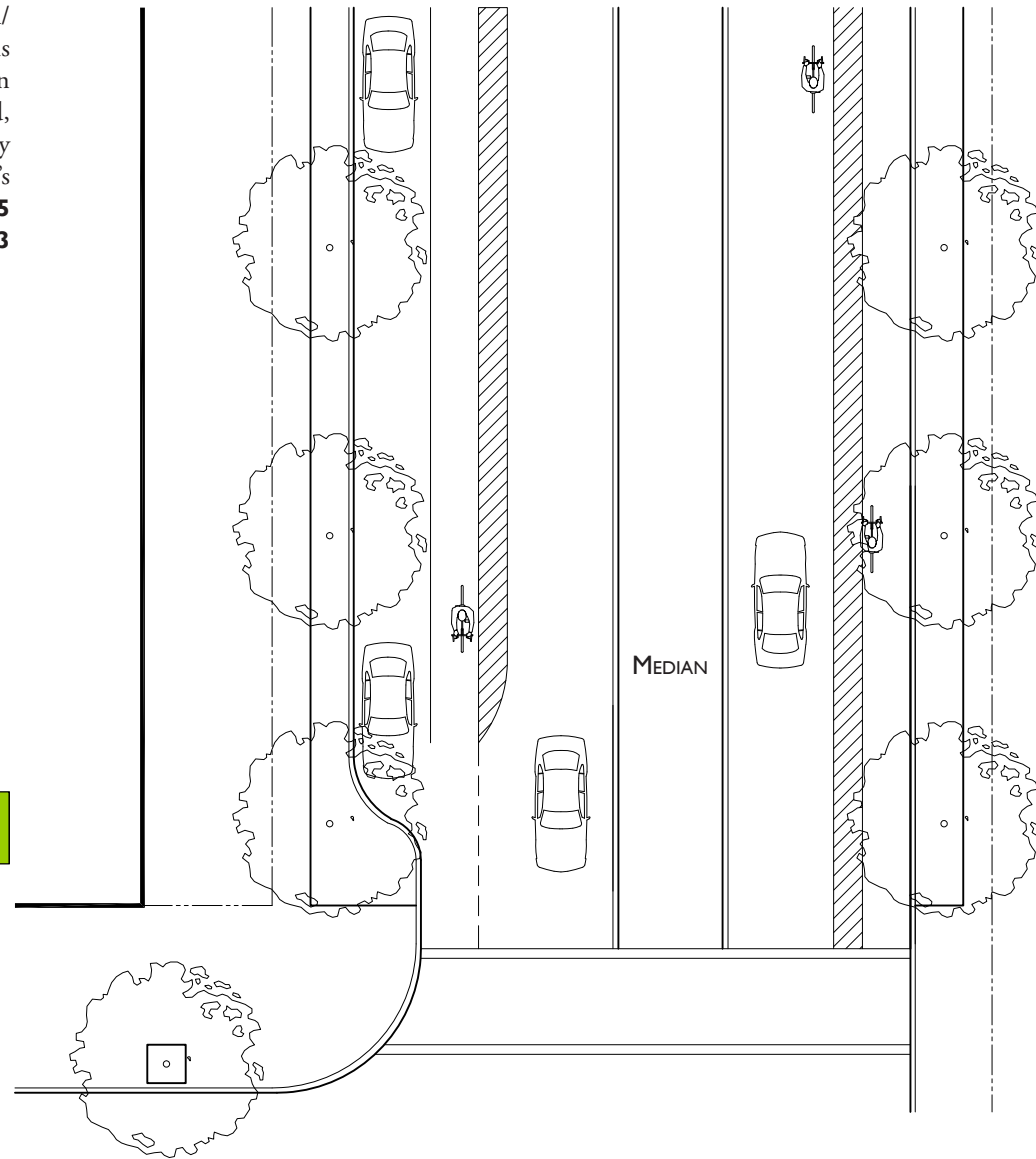

10

EXHIBIT 10.23 – STREET TYPE 10.1: TYPICAL INTERSECTION (PLAN VIEW)

10.0 STREET STANDARDS

ST 10.2: PARK EDGE DOUBLE-LOADED

10

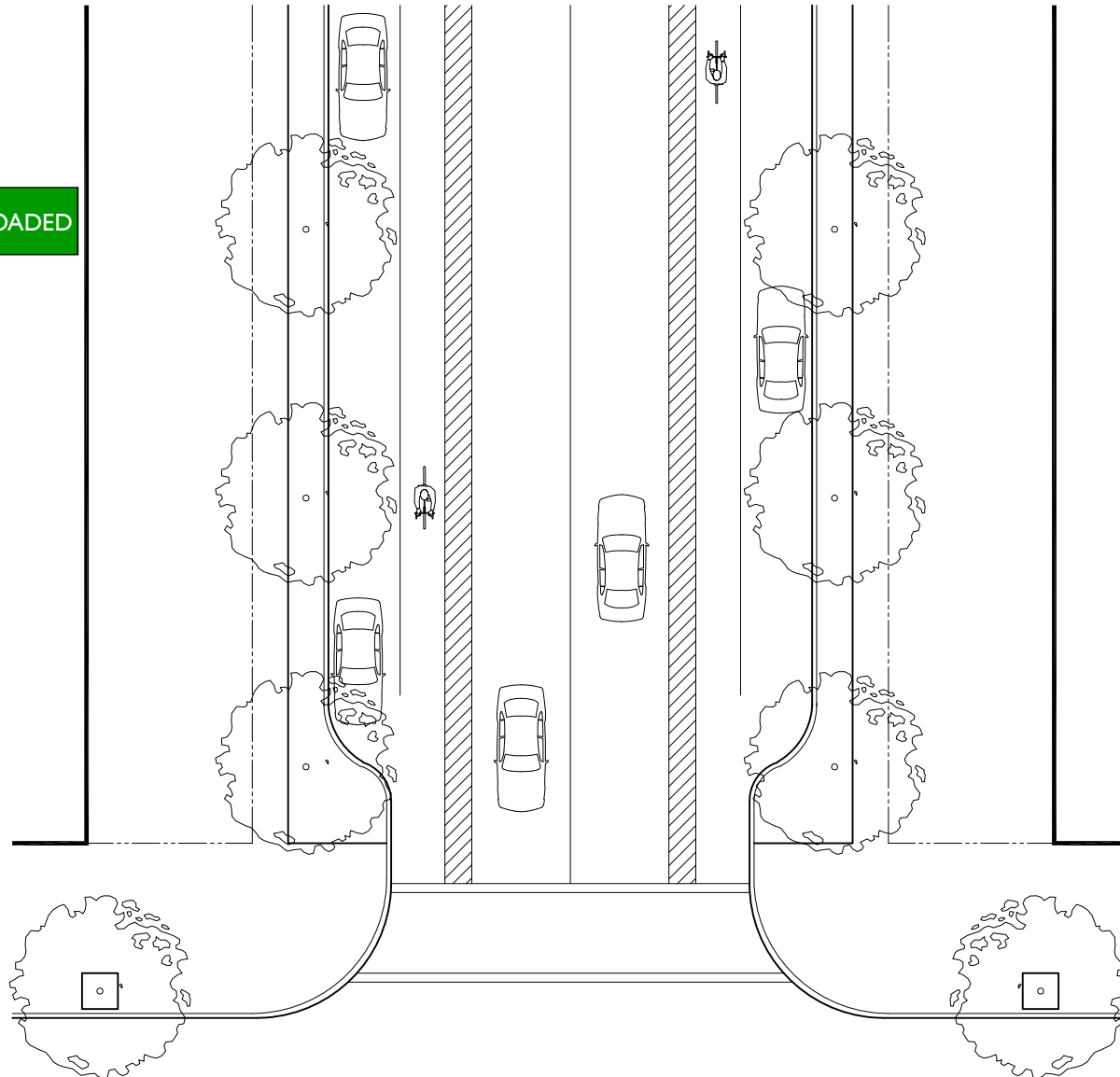

EXHIBIT 10.24 – STREET TYPE 10.2: TYPICAL INTERSECTION (PLAN VIEW)

10.0 STREET STANDARDS

10.7. Secondary Street Design Standards

- 10.7.1. The platting of new dead-end streets and culs-de-sac that terminate the road is prohibited.
- (i) Stub streets or “knuckle” culs-de-sac are allowed where necessary to reach no more than 4 parcels beyond a corner or intersection.
 - (ii) Mid-block “bubble” culs-de-sac without throats are allowed.
 - (iii) Pedestrian/bike connections shall be provided to open space and/or road networks beyond knuckle or bubble culs-de-sac.

10.7.2. Required ‘A’ vs. ‘B’ Streets

- (i) New development shall include Secondary Streets to serve projects where needed to supplement Primary Streets, per the requirements in **Table 10.2**, which includes both Primary and Secondary Streets.
 - a. **‘A’ vs. ‘B’ Percentage:** The percentages given are ratios for the minimum number of **‘A’ Streets** and maximum number for **‘B’ Streets**. For example, for a project within Town Center, a minimum of 1 of every 2 **Secondary Streets** shall be planned as **‘A’ Streets**. If more than half the streets are planned as **‘A’ Streets**, the **‘B’ Street** percentage would be reduced accordingly. In Regional Center, for example, at least 1 of every 4 roads shall be an **‘A’ Street**. See **Exhibit 10.19**.

- b. **Connectivity: Secondary Streets** added in Volcano Heights shall maintain or improve street connectivity to serve pedestrians as well as dispersing auto traffic.



TABLE 10.2 – STREET REQUIREMENTS

CHARACTER ZONE		STREETS	
		‘A’ Street (min.)	‘B’ Street (max.)
	Town Center	50%	50%
	Regional Center	25%	75%
	Village Center	25%	75%
	Mixed Use	25%	75%
	Neighborhood Transition	0%	100%
	Escarpment Transition	25%	75%

[Amended November 5, 2014]

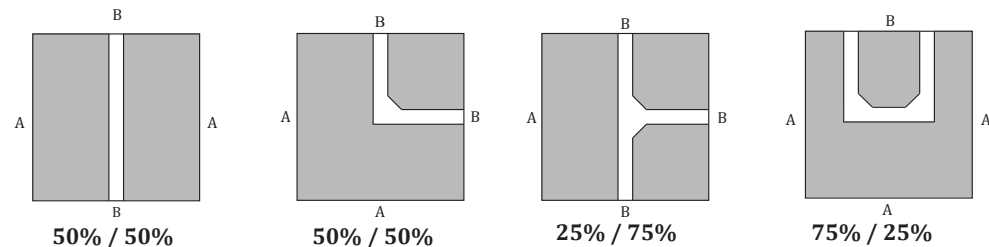

EXHIBIT 10.19 – EXAMPLE DIAGRAMS: ALLEY CONFIGURATIONS WITH ‘A’ vs. ‘B’ STREET PERCENTAGES

10.0 STREET STANDARDS

(i) The first development in shall determine Secondary Street designation (i.e. whether 'A' or 'B') for the block. Streets shall be platted as such during the TIDD/SAD/PID and/or Site Development Plan for Subdivision process. Street designations may only change at intersections. Street designations may only change from an 'A' Street to a 'B' street when intersecting with another 'A' street to ensure connectivity for the pedestrian.

[Amended November 5, 2014]

10.7.3. Secondary Street Cross Sections

- (i) **Table 10.3** specifies typical sections for **Secondary Streets**.
- (ii) The elements may be arranged to best meet local conditions and intended character of the corridor.
- (iii) Where a Secondary Street crosses property lines, **adjacent** property owners may be required to sign a legally binding agreement duly executed and acknowledged for the agreed-to cross section as the first project is being planned and before final project approval is granted.

(iv) Typical cross sections for '**A**' Streets and '**B**' Streets are illustrated in **Exhibit 10.20** and **Exhibit 10.21**, respectively. Typical Cross Sections for Residential and Commercial Alleys are illustrated in **Exhibit 10.22** and **Exhibit 10.23**, respectively.

TABLE 10.3 – TYPICAL SECONDARY STREET AND ALLEY CROSS SECTION OPTIONS

STREET ELEMENTS	STREET ROW	#VEHICULAR LANES	VEHICULAR TRAVEL LANE WIDTHS (max.)	BIKE LANE	ON-STREET PARKING	PEDESTRIAN SIDEWALK WIDTH (max.) * includes easement(s)	PARKWAY/TREE WELL
'A' Street	54-96 feet	2-3 (includes 12-ft. center turn lane)	10 (11) feet	None	7-18 feet (reverse-angle parking requires 16-18 feet)	10 (12) feet	(optional within sidewalk width)
'B' Street	48-96 feet	2-4	11 (13) feet	None	7 feet	6 (10) feet	(optional with sidewalks at least 8 feet wide)
Commercial Alley	20-36 feet (all paved)	N/A	N/A	None	None	None	None
Residential Alley	20-30 feet (12 feet minimum paved)	N/A	N/A	None	None	None	None

10.7.4. Typical 'A' Street

- (i) **Intent/Purpose:** **Secondary 'A' Streets** are intended to provide the primary pedestrian access to development. They should be pedestrian-friendly and attractive, including streetscape amenities and landscaping. See **Exhibit 10.20**.
- (ii) Streets are to have 10-foot minimum sidewalks but 12 feet where possible. Larger sidewalks are encouraged as long as the primary **building** is positioned **abutting** the sidewalk.
- (iii) Drive lanes are to have a typical dimension of 10 feet but may be increased to no more than 11 feet wide for each lane where transit is anticipated.
- (iv) On-street parking may be parallel or angled parking. Where angled parking is used, the ROW shall be increased to add that element (reverse-angle parking typically requires 16-18 feet) while still maintaining appropriate dimensions for all other elements. A median is also recommended with reverse-angle parking.
- (v) When incorporating a median, the median is to have a minimum of 2 feet wide and provide enough additional width to allow vegetation to be planted and sustain itself within the entire median, including turn bays.
- (vi) For streetscaping, see **Section 11.2** starting on page 206 of this Plan.
- (vii) For street lighting, see **Section 11.4** starting on page 209 of this Plan.

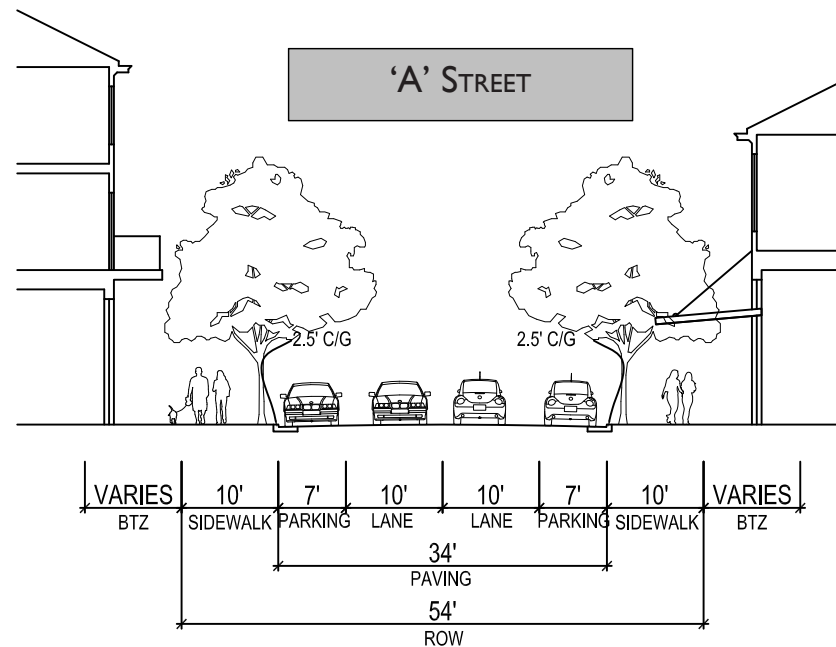

EXHIBIT 10.20 – TYPICAL 'A' STREET CROSS SECTION

10.0 STREET STANDARDS

10.7.5. Typical 'B' Street

- (i) **Intent/Purpose:** **Secondary 'B' Streets** are intended to provide the primary automobile access to development. They should serve both potential customers and residents as well as service, delivery, and maintenance vehicles. See **Exhibit 10.21**.
- (ii) Streets are to have 6-foot minimum sidewalks but 8 feet where possible. Where street trees are added to the cross section within the allowance for the sidewalk, the sidewalk portion, including the tree well, is to be no less than 10 feet wide.
- (iii) Drive lanes are to have a typical dimension of 11 feet where trucks and transit are expected but may be decreased to no less than 10 feet wide for each lane for streets that will largely accommodate autos and where slower speeds are desirable, such as residential and retail areas.
- (iv) On-Street parking is to be parallel.
- (v) Off-street parking visible from the public **ROW** along the **'B' Street** is to have a **street screen** of masonry, metal railing, vegetation or a combination of these. This street screen is to be a minimum of 3 feet and no more than 6 feet tall.
- (vi) Medians are not permitted on **'B' Streets**.
- (vii) For streetscaping, see **Section 11.2** starting on page 206 of this Plan.
- (viii) For street lighting, see **Section 11.4** starting on page 209 of this Plan.

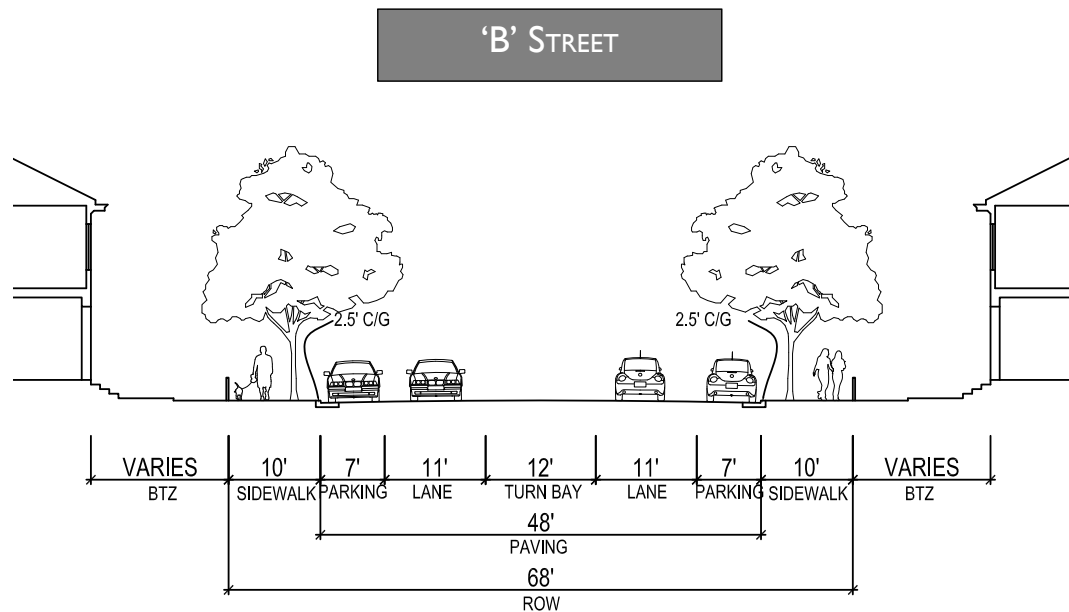

EXHIBIT 10.21 – TYPICAL 'B' STREET CROSS SECTION

10.7.6. **Typical Alleys:** Prior to site development, an exhibit may be required to demonstrate appropriate truck turning movements for proposed alley configurations.

(i) **Residential**

- a. *Purpose / Intent:* Provides access to parking, outbuildings, and service areas in back. Contains utility easements.
- b. *ROW width:* 20 feet
- c. *Pavement width:* 12 feet minimum
- d. *Design speed:* 10 miles per hour

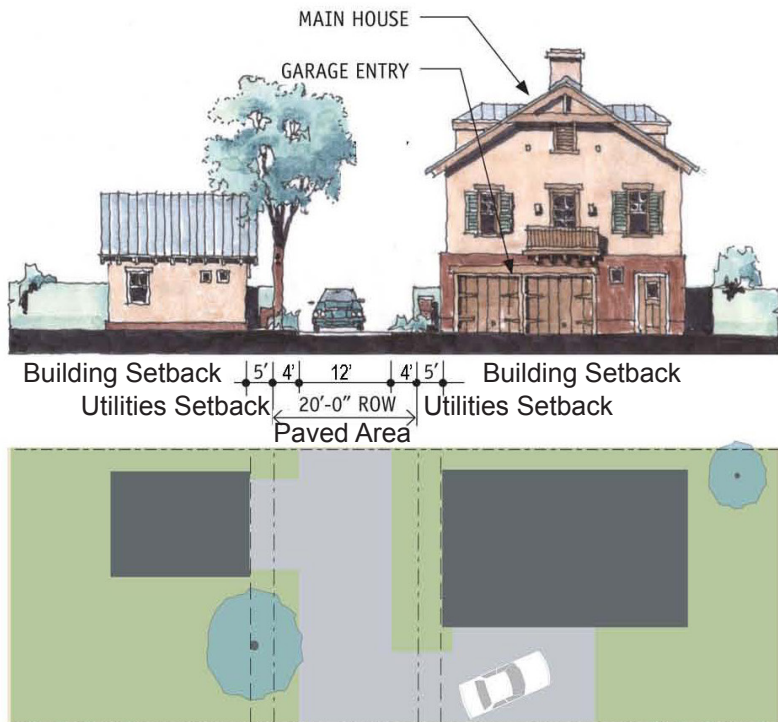

EXHIBIT 10.22 – TYPICAL RESIDENTIAL ALLEY CROSS SECTION

(ii) **Commercial**

- a. *Purpose / Intent:* Provides access to parking, outbuildings, and service areas in back. Contains utility easements.
- b. *ROW width:* 20 feet
- c. *Pavement width:* 20 feet minimum
- d. *Design speed:* 15 miles per hour

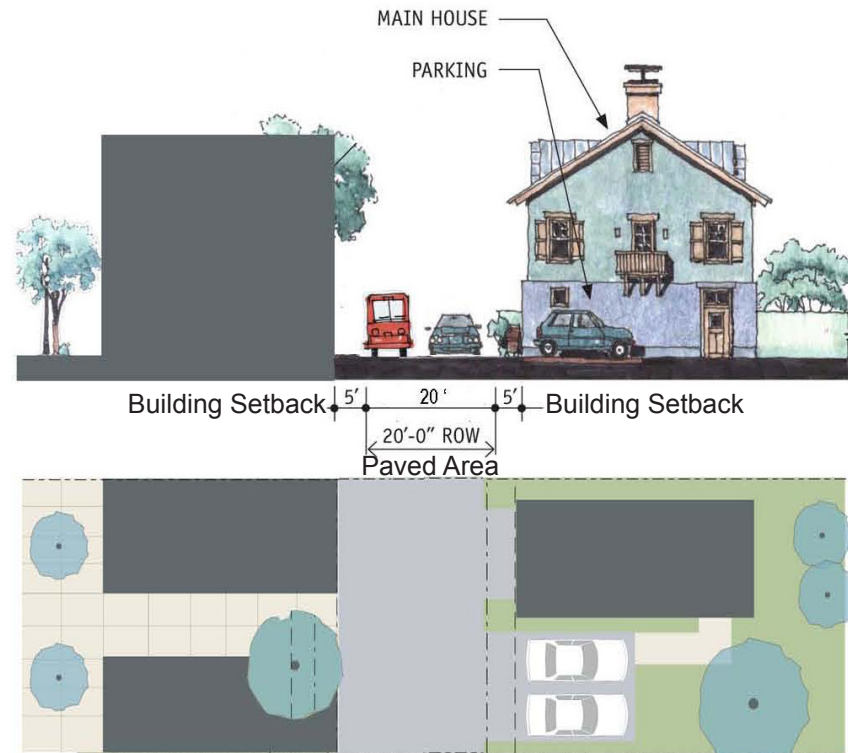

EXHIBIT 10.23 – TYPICAL COMMERCIAL ALLEY CROSS SECTION

10.0 STREET STANDARDS

10.7.7. **Typical Streets with Public Utility Easement**

- (i) Utilities are typically to be provided via alleys. Where alley access is not possible, electric utility facilities need to be accommodated on streets.
- (ii) Where electric utility facilities must be accommodated on streets, a 10-foot setback is to be placed between the sidewalk and the Build-to-Zone behind the private property line for this purpose. This setback may be landscaped with the understanding that it might be removed as necessary for maintenance and/or repair of utilities.

11.0 STREETScape STANDARDS

11.0 STREETScape STANDARDS

11.1. Adjustments

- 11.1.1. The following streetscape standards, including street tree planting and street lighting, may be adjusted based on the development context and street cross section.
- 11.1.2. Any adjustments to the streetscape standards should be assessed based on specific development context such as vegetation, natural features, drainage, and fire access and are subject to approval by the Planning Director or his/her designee and/or relevant City department.

11.2. General Streetscape Standards

11.2.1. Groundcover:

- (i) Where clearly visible from a street or **alley**, all unpaved ground areas are to be planted with low-growing shrubs or ground cover, ornamental grasses, or a combination thereof selected from the Plant List in **Table 9.5** starting on page 153. [For more detail, see **Section 9.7.3** starting on page 151.]
- (ii) Within 200 feet of the Petroglyph National Monument, only species listed as native in the Plant List in **Table 9.5** starting on page 153 are to be used, except for street trees. [See **Section 11.3** for street tree standards.]

- 11.2.2. **Irrigation:** Irrigation is to be provided by the property owner for all plants and trees in the streetscape, per City standards. [Contact City Design Review/Construction (DRC) Section in the Planning Department for the latest standards].

- 11.2.3. **Streetscape Maintenance:** Maintenance of all landscape materials is the responsibility of the **adjacent** property owner and shall meet the requirements of Chapter 6, Article 6 in the City Code of Ordinances.

- 11.2.4. **Sidewalk Design:** Sidewalks in the public **ROW** are to be designed to facilitate pedestrian accessibility and efficient travel. Curvilinear sidewalks are strongly discouraged. Where possible, landscape strips should be used to buffer pedestrians from vehicle traffic and set the pedestrian path back from driveway ramps.

- 11.2.5. **Grading: Bikeways** and other amenities within the **ROW** are to be provided in such a way as to minimize the extent of disturbance to slopes and vegetation and the need for cut and fill.

- 11.2.6. **Medians:** Medians are to be constructed and landscaped per City standards. [For medians: **DPM** Chapter 23, Section 5, Part C. For landscaping: contact **DRC** Section for the latest standards.]

11.2.7. Bike Lanes and Bike Buffer

- (i) Where cross sections incorporate a bike buffer in addition to a bike lane, the buffer is to be no less than 2 feet wide.
- (ii) Best practices to minimize conflict between bicycles and vehicles turning right at intersections are to be followed, including design solutions, pavement painting, signage, and/or other accommodations.

11.2.8. **Encroachments**

- (i) Encroachments are permitted by a revocable permit and subject to license and fees per the **DPM**, Chapter 8.
- (ii) Projections such as, portals, stoops, colonnades, arcades, shop fronts, projecting signs in public utility easements and other projections are to be coordinated with the electric utility to accommodate existing easements and to avoid conflicts with utility infrastructure. Projections adjacent to electric utilities are to be carefully located in order to avoid interference and to accommodate equipment for the maintenance and repair of electric utilities.

11.3. **Street Tree Standards**

- 11.3.1. **Purpose/Intent:** Street trees are an amenity first for pedestrian comfort and enjoyment, next for enhancement of **abutting** properties, and finally for passing motorists, cyclists, or transit riders. Street trees are to be chosen and incorporated to serve the following intents:
 - (i) Enclose or frame the space of the street with a canopy.
 - (ii) Provide shade.
 - (iii) Provide a buffer between traffic and pedestrian to enhance the feeling of safety for the pedestrian.
 - (iv) Provide an aesthetic accompaniment to nearby architecture.
 - (v) Reduce the heat island effect created by paved surfaces.
 - (vi) Aid in storm water management through transpiration.
 - (vii) Work within their context (i.e. region- and climate-appropriate, native species that are disease resistant and drought-tolerant).
- 11.3.2. On all **'A' Streets**, street trees are to be provided, irrigated, and maintained by adjacent property owners per the Street Tree Ordinance, Section 6-6-2-1.
- 11.3.3. Wherever used, all street trees shall be maintained by the adjacent property owner, per the Street Tree Ordinance, Section 6-6-2-1.



11.0 STREETScape STANDARDS

- 11.3.4. Street tree location and selection is to be coordinated with the Planning Director or his/her designee and consistent with the Street Tree Ordinance 6-6-2-1.
- (i) PNM will need to provide input on street tree location and selection if impacting electric facilities.
 - (ii) Shade structures may be substituted for street trees in select locations subject to approval of the Planning Director or his/her designee. An encroachment permit may be required. [See **Section 11.2.8** starting on page 207 for details about encroachments.]
- 11.3.5. In order to ensure that street trees are appropriate for the region and climate and are not invasive species, street trees are to be selected from the Plant List in **Table 9.5** starting on page 153 of this Plan [see also **Section 9.7.3** starting on page 151]. Non-invasive low-water and/or xeric species may be selected with **approval** from the Planning Director or his/her designee in consultation with the City Forester. Street trees should be disease resistant and drought tolerant.
- 11.3.6. Where available, street trees are to be planted within the landscape area in the public right-of-way. [See cross sections in **Section 10.0** starting on page 163.] Otherwise, street trees are to be planted between the sidewalk and the street curb using tree grates.
- 11.3.7. Where provided, spacing is to be an average of 30 feet on center (measured per block face) in order to provide a continuous canopy. On narrow streets, spacing may vary on each side of the street. Spacing may be adjusted as appropriate to accommodate optimum root growth for native species.
- 11.3.8. Each planting area is to be no less than 36 square feet (SF). The tree well is to be no less than 25 SF. On **'A' Streets**, trees are to be in a grated or permeable planting square a minimum of 4 feet wide. Metal tree grates are preferred for **'A' Streets**.
- 11.3.9. The minimum **caliper** size (i.e. diameter of the tree trunk measured six inches above grade) for each tree is to be 3 inches at planting. Caliper size for a multi-trunk tree is to be the total of the diameter of the largest trunk and half (1/2) the diameter of each additional trunk, measured at a height of 4 1/2 feet above the ground.
- 11.3.10. Planting is to be planned to provide a canopy with a base no less than 7 feet high at time of maturity for vertical clearance of pedestrians and vehicles. On **'A' Streets**, the base of the canopy is to be planned for a minimum of 14 feet so as to not obscure windows and signage.
- 11.3.11. Planters for street trees are to be a minimum of 36 inches wide.

11.0 STREETScape STANDARDS

11.4. Street Lighting Standards

11.4.1. Purpose/Intent

- (i) Outdoor lighting should create and encourage a pedestrian-friendly environment, which is especially beneficial to residential neighborhoods and neighborhood business districts. Pedestrian-scale lights should improve walkway illumination for pedestrian traffic and enhance community safety and business exposure.
- (ii) Street lighting should be designed to be appropriate to location and context. Lamp post height, lamp head, lighting source, and spacing should all be calibrated. The light standard selected should be compatible with the design of the street and dominant architectural style of **adjacent buildings.**

11.4.2. Street lights are to be placed at 30 feet on center and in-line with street trees. Street trees and light poles are to be alternated along the street.

11.4.3. All street lighting is to be “full-cutoff” or “fully shielded” to minimize light pollution and save energy, per the New Mexico Night Sky Ordinance [74-12-1 to 74-12-10 NMSA 1978].

11.4.4. Lamp post height is to be designed to be proportional to the width of the street. Street lamps are to be 12 to 15 feet high along **‘A’ Streets.** **‘B’ Streets** are to incorporate 15-foot lampposts. [See **Section 9.8** starting on page 159 for parking area lighting requirements.]

11.4.5. For those intersections that require more light, the 20-foot lamppost can be instituted for safety, but should be used only if necessary.

11.4.6. **Cobraheads** are to only be used on Paseo del Norte and Unser Boulevard to light vehicle lanes as necessary. A supplemental non-cobrahead light is to be mounted between 12 to 14 feet to light sidewalks, pedestrian paths, or multi-use trails.

11.4.7. The minimum clearance from a street light pole to the face of curb is 2 feet. The minimum clearance from a street light pole to the edge of a sidewalk is 1 foot. The minimum clearance from a street light pole to the centerline of a street is 20 feet.

11.4.8. Light posts are to be placed within the landscape strip where available.

11.4.9. All lamp posts are to have a base, middle, and top.

11.4.10. Shoe box style lighting is not to be used, except in large parking areas. Metal halide lights are encouraged. High pressure sodium lights are discouraged since they visually render all colors the same.

11.4.11. **Column streetlights** are to be used on **‘A’ Streets.**

11.4.12. Multi-head **column streetlights** are to be used on **‘A’ streets,** Unser Boulevard, and Paseo del Norte.

11.4.13. All new **alleys** are to have lights mounted on outbuildings or garages.



11.0 STREETScape STANDARDS

11.5. Street Furniture and Materials Standards

11.5.1. Purpose/Intent

- (i) Street furniture should create and encourage a pedestrian-friendly environment, which is especially beneficial to residential neighborhoods and neighborhood business districts.
- (ii) Street furniture should be designed to be appropriate to location and context. Street furniture should be compatible with the design of the street and dominant architectural style of **adjacent buildings**.
- (iii) Materials for paving and street furniture should be selected based on durability, quality, and minimal maintenance requirements.

11.5.2. **Responsibility:** Street furniture and streetscape amenities are the responsibility of the property owner and/or property owner association or merchants association. The cost for construction, maintenance, operations, and liability is to be borne by private entities.

11.5.3. **Placement:** Street furniture placement and procedure is to follow the **DPM** Chapter 8.

- (i) Street furniture is not to be placed within the public ROW without the approval of the relevant City agency, which may include the City Engineer, Zoning Enforcement Officer, and/or Code Administration Division.
- (ii) Where street furniture is placed within a public utility easement, approval by utility companies will be required.

11.5.4. Trash receptacles and bike racks are to be placed along **'A' Streets** within Town Center, with a minimum of one each per block face.

11.5.5. Where provided, street furniture and pedestrian amenities such as benches are to be placed to maximize pedestrian access and circulation along **'A' Streets**. All street furniture is to be located in such a manner as to allow a clear sidewalk passageway of a minimum of 6 feet.



CHAPTER IV

goals, policies, and implementation

This Page Left Intentionally Blank

12.0 GOALS

12.0 GOALS

Intent: The following goals are intended to support the policies set forth in the Rank 1 Albuquerque Bernalillo Comprehensive Plan, the Planned Growth Strategy, the Rank 2 West Side Strategic Plan, and the Rank 3 Northwest Mesa Escarpment Plan. The goals represent the overarching intent of the Plan. These goals are furthered in **Section 13.0 Policies** starting on page 223.

12.1. Environment and Open Space: The following goals are furthered with policies found in **Section 13.1** starting on page 224.

12.1.1. Establish an interconnected open space network comprised of parks, arroyos, the Petroglyph National Monument, and other open spaces.

An organized system of open space can help conserve the natural environment, mitigate the impacts of development, provide exceptional recreational opportunities, and increase property values and quality of life for residents, employees, and visitors in and around Volcano Heights. Opportunities to experience and enjoy nature should be plentiful, especially for children. Often, these open space features can form the boundary of neighborhoods and maintain views to the Volcanoes and Sandia Mountains.

12.1.2. Respect Albuquerque’s culture and history, including Hispanic and Native American, through context-sensitive development in Volcano Mesa.

Volcano Mesa provides a unique portal to understand the rich interplay of cultures that is New Mexico. The stories and meaning of this place to Native Americans can be told through living in and visiting Volcano Heights, which should influence the way this special area develops. Volcano Heights should be an entry point for Albuquerque residents into different and important perspectives on humanity’s place on earth and our spiritual paths.

12.1.3. Conserve Volcano Heights’ archaeological resources and protect and emphasize views and visual connections to the volcanoes, Sandia Mountains, and the Rio Grande.

The volcanoes, Petroglyph National Monument, outcrops of basalt (especially those containing petroglyphs), the Sandia Mountains, and other locations are sacred places for many Native Americans, and they still figure into their ceremonial practices. Views can be protected and enhanced through considerate site planning and by creating view corridors using streets and arroyos. Important views from locations within Volcano Heights to the Rio Grande basin, across the city of Albuquerque, and to the Sandia Mountains should be protected.

- 12.1.4. **Maintain scenic edges, protect important views, and minimize the visual impact of development that can be seen throughout the city.**

The built environment and landscape along the edge of the Petroglyph National Monument will form a pleasant transition from the natural area to the developed area. Open space constitutes an important resource that demands special landscape and architectural treatments. As development within the Volcano Heights Major Activity Center will be visible from most of the City of Albuquerque, care should be taken to achieve development that is not visually intrusive, especially in the lower-density residential areas adjacent to the Petroglyph National Monument. Appropriate building heights, sizes, and reflectivity will minimize the visual impact of development.

- 12.1.5. **Encourage infrastructure strategies that are economically, aesthetically and environmentally sound.**

Electrical utility distribution lines should be placed underground. Infrastructure improvements should promote and make visible an environmental ethic for the area. Infrastructure should be designed and constructed to enhance and/or encourage sustainable developments. Drainage treatments should respect sensitive lands such as Piedras Marcadas Canyon, the Petroglyph National Monument, and significant rock outcroppings, as well as the unique aesthetics of the area. Transportation infrastructure should enhance the economic sustainability of the community by offering viable choices for multiple modes of travel for people of all ages and abilities.

- 12.1.6. **Minimize the negative effects of blasting and fugitive dust to the Petroglyph National Monument.**

Development design and construction activities should be carefully planned to minimize negative impacts to the Petroglyph National Monument. Property owners should consult with the City Open Space Division and National Park Service on strategies, monitoring, and construction techniques to ensure compliance with requirements and standards.

- 12.2. Economic Development:** The following goals are furthered with policies found in **Section 13.2** starting on page 225.

- 12.2.1. **Provide a variety of employment opportunities that provide livable wages and high-quality work environments.**

Economic development and recruitment efforts should emphasize businesses that provide livable wages and high-quality work environments.

- 12.2.2. **Achieve a sustainable and vital mix of regional- and local-serving retail and services.**

This Plan seeks to help minimize the jobs/housing imbalance between Albuquerque’s West and East sides by creating a Major Activity Center that serves local and neighboring populations. A densely-developed mix of commercial activities that meets a wide range of needs will encourage visitors to “park once and walk” to multiple destinations and attract residents and large employers to the area.

12.0 GOALS

12.2.3. **Coordinate development across property lines and among multiple property owners.**

This Plan advocates coordination among property owners, including the possibility of working with a Master Development Coordinator who can partner with owners to oversee the improvement of all properties. This strategy is particularly helpful to coordinate infrastructure planning and construction, including grading, roads, and utilities to prepare properties for development. A master development coordinator would be instrumental in preparing an application for a TIDD, an SAD, or a PID to benefit multiple property owners, if not the whole Plan area.

An experienced, third-party master developer and/or marketing strategist can also help to coordinate complex projects with a variety of development types and/or projects that will overlap and/or follow one another.

12.2.4. **Establish a Major Activity Center in order to provide significant long-term economic development opportunities while also providing for the social, cultural, and environmental needs of the Volcano Mesa area.**

The development of a Major Activity Center in this area can help achieve a diverse and balanced set of uses that would spur economic development and reduce the need for West Side residents to travel long distances to access employment and other daily services. Allowing a wide range of uses that support the establishment of a Major Activity Center can serve as a catalyst for private investment and the creation of much-needed jobs west of the Rio Grande. Capitalizing on and respecting the unique resources and features of the area, such as the Petroglyph National Monument and rock outcroppings, will strengthen “sense of place” and contribute to successful development.

12.3. Transportation: The following goals are furthered with policies found in **Section 13.3** starting on page 226.

12.3.1. Provide a choice of viable transportation options for commuting and daily needs.

Walking is a safe, viable travel option, especially for children and the elderly, for recreation, commuting, and shopping. For greater distances, transit should offer a convenient alternative to single-occupancy vehicles. Transit, in particular, could lessen reliance on the automobile, reducing pollution, congestion, and pressures to widen roads and bridges, especially at regional “pinch points” like the Rio Grande and the Escarpment.

12.3.2. Support an efficient and reliable transit system.

To support as frequent service as possible and maximize ridership with less public subsidy, transit stop locations should be coordinated with the development of higher density residential and employment uses. More intense corridors should include major retail, commercial, and employment destinations. Doing so will allow the earliest implementation of traditional transit service, which can eventually segue to **BRT** systems using specialized vehicles and techniques that make transit travel times competitive with the single-occupancy vehicle. While transit service may initially share general purpose travel lanes, all arterial streets in this Plan have ultimate cross-sections with enough right-of-way and flexibility to accommodate transit in multiple configurations, including as dedicated transit lanes on the outside edges or along extra-wide medians.

12.3.3. Create “Complete Streets” for people as well as cars, by providing street trees, landscaping, wide sidewalks, and active uses.

Streets should feel safe and comfortable for pedestrians and work well for all other modes of transportation. The design of streets and the buildings that face them influences whether someone will choose to walk. Pedestrian-friendly streets have sidewalks that promote both circulation and activity, street trees, and slow-moving traffic. They also have pedestrian-scaled buildings with frequent entries, windows, and attractive features. Parking lots and blank walls should be minimized along pedestrian routes.

12.3.4. Connect different uses and areas by an efficient and convenient street network.

Streets should create safe and direct connections between common destinations, not act as barriers that separate people and neighborhoods. Streets should be designed to control vehicle speeds and be a comfortable place for neighbors to interact. Rather than concentrate traffic, highly connected streets form a grid and distribute traffic among roadways. A street network grid also creates redundancy for additional safety and emergency response.

12.0 GOALS

- 12.3.5. **Retain the primary purpose of Paseo del Norte and Unser Boulevard to serve regional traffic, while balancing the needs of the local road network to serve new development and multiple modes of traffic, including pedestrians.**

The Plan recognizes the limited-access nature and classification of Paseo del Norte and Unser Boulevard. At the same time, the Plan proposes land uses and a **Primary Street** network intended for safe, attractive, dense, pedestrian-friendly urban environment, including a “loop road” of connector streets that provides alternative access to development off Paseo del Norte and Unser Boulevard. As the area develops over time, the goal is to “tame” these roads to help create a gateway to a more urban, walkable environment. These regional roads will give the first “sense of place” to many potential visitors to Volcano Heights and should reflect and complement the area’s character accordingly, while still functioning as limited-access, primary regional arterials.

- 12.3.6. **Remove restrictions on truck traffic on key roads to provide truck access necessary to support retail and commercial uses.**

Several roads on the West Side restrict truck traffic. The City **DMD** should work with the Mid-Region Council of Governments (MRCOG) and its constituent jurisdictions to remove or modify several of these restrictions in order to facilitate truck movement to serve businesses and improve services on the West Side.

- 12.4. **Land Use and Urban Design:** The following goals are furthered with policies found in **Section 13.4** starting on page 238.

- 12.4.1. **Recognize walkable neighborhoods and districts as the essential building blocks of a more sustainable city and region.**

Strong and healthy neighborhoods, because they operate at a scale where people walk and interact, are essential to successful and sustainable development. Organizing development within walkable mixed-use districts and neighborhoods supports transit, economizes on infrastructure, and respects the environment. Requiring that development comply with design standards that support the creation of safe, comfortable, and visually attractive settings supports a community’s long-term economic, cultural, and social viability.

- 12.4.2. **Bring homes, businesses, and daily destinations — like retail and community facilities — closer together within neighborhoods and districts.**

Homes should be within walking distance of a mixed-use center containing retail, community services, park and plazas. Studies have shown that this walkable pattern of development can reduce the number of vehicle-trips dramatically. Walkable districts and neighborhoods also have proven social and economic benefits resulting from better access to basic needs, services, and amenities; safer and more active streets; and improved health through physical activity.

- 12.4.3. **Encourage architectural and landscape treatments that are consistent with the region's traditions and climate and help to establish a unique sense of place.**

New development in Volcano Heights should continue to respect and enrich Albuquerque's design traditions that spring from its arid climate, intense sun, local materials, and the cultural background of its inhabitants. These considerations deserve continued attention to respect the past and work toward an energy- and water-efficient future. The quality of individual buildings contributes to a sense of place and permanence. High standards for architectural and landscape design for individual buildings, lighting, utilities, walls, and landscaping materials help to create a built environment with lasting character that draws on southwestern regional styles and traditions. Standard franchise architecture should be discouraged. Individual design expression within distinctive character districts should contribute to an overall framework of quality. Buildings should be designed to address the unique climatic conditions of the southwest, including orientation to conserve water, protect pedestrians from intense summer sunlight and heat, provide adequate heating during cold winters, and take advantage of natural lighting.

- 12.4.4. **Promote diverse housing options throughout Volcano Heights.**

A variety of housing types—at varying densities—allows the opportunity for residents to move through all stages of life within the same neighborhood. Housing diversity will also promote and attract businesses to balance residential development on the West Side.

- 12.4.5. **Support the creation of a major employment center in Volcano Heights.**

Most working West Side residents commute to work on the east side of the Rio Grande (many in downtown Albuquerque or along Interstate 25), which contributes to regional traffic congestion at river crossings and on the West Side. Major job growth in Volcano Heights will provide opportunities for working closer to home, minimizing the need for river crossings or reversing commutes in a direction where roads have existing capacity. A frequent and reliable transit service for this Major Activity Center will further improve commuting times.

12.0 GOALS

- 12.4.6. **Establish a mixed-use Major Activity Center as a transit-oriented development that offers a range of retail, commercial, and entertainment destinations; urban housing; and employment opportunities.**

A Major Activity Center should encourage higher-density and higher-intensity opportunities for residential options and employment areas. While neighborhood retail can meet most daily requirements, many needs must be met within larger centers that serve larger populations. A mixed-use Major Activity Center should encourage opportunities for comparison shopping, entertainment, restaurants, cultural activities, and government services.

Unlike many exclusively single-family residential subdivisions, Volcano Heights should offer dense urban housing in mixed-use environments for those who prefer them, which greatly increases the likelihood of walking and transit use. Transit, amenities, and housing in the Major Activity Center will help attract employment to the West Side.

- 12.4.7. **Incorporate street infrastructure and streetscape details that support the creation of distinct, pedestrian-friendly districts.**

Where taller lights are required, for example a major thoroughfare, consideration should be given to a design appropriate to the larger scale. Reproductions of historic lamps such as the “bishops crook” poles are a more aesthetic solution than the cobra head.

- 12.4.8. **Locate more active uses nearest to transit, bikeway, and pedestrian facilities. Locate auto-oriented uses near ‘B’ streets.**

This Plan distinguishes between ‘A’ streets, which are designed to best accommodate pedestrians, transit users, and cyclists, and ‘B’ streets, which are meant to be more auto-oriented. Development that includes active street life, such as theatres and restaurants with patio seating, should be located along ‘A’ streets, as near to transit as possible. Auto-oriented development should be located along ‘B’ streets to provide the primary auto access to development.

- 12.4.9. **Achieve a walkable built environment through a vital mix of retail and services near higher-density residential development.**

Pedestrian-friendly commercial areas will benefit from the additional “eyes on the street” and customer base provided by high-density residential development like apartments, lofts, and condominiums. Ultimately, this vibrant “critical mass” of residents and retail and service providers will contribute to the creation of a “sense of place” in Volcano Heights that can help attract additional employers and businesses to the area.

12.5. Infrastructure: The following goals are furthered with policies found in **Section 13.5** starting on page 241.

12.5.1. Provide for the orderly expansion of infrastructure and public facilities in the area.

Infrastructure improvements in Volcano Heights will need to be phased in a way that recognizes technical limitations and available funding and that provides infrastructure and facilities in a timely way to meet the needs of residents, businesses, and local employees.

12.5.2. Leverage public/private partnerships and financing for infrastructure improvements that position the area for development.

The dense, transit- and pedestrian-friendly development envisioned in this Major Activity Center will require transportation infrastructure that serves all users with enhanced pedestrian realms, dedicated transit facilities, and other features not found in conventional residential subdivisions. Collaboration among property owners to use existing public/private partnership mechanisms, like TIDD, SAD, or PID for the orderly construction of transportation and other necessary infrastructure on a large scale, rather than piecemeal, will help attract development and employment to the area.

12.5.3. Invest in and incorporate the most up-to-date technology and maximum capacity for infrastructure and utilities.

The best technology and highest capacity should be planned for infrastructure and utilities, particularly telecommunications, in order to attract and support high-tech businesses as well as a diverse spectrum of desirable commercial activity.

12.5.4. Coordinate among property owners to leverage investment in water source and water quality improvements.

Volcano Heights spans two water pressure zones, one of which is smaller than the City's standards size, as it was previously owned by New Mexico Utilities. The amount of bedrock in the area, the presence of arsenic, and the need for a new water tank to support new development will pose significant front-end costs before any development can occur. These improvements could be included in a TIDD, SAD, or PID, which would provide a mechanism to share the costs across property owners based on the potential benefits to each property. [See **Section 14.0 Implementation** starting on page 245 in this Plan and **Appendix A** for more explanation of pre-Existing conditions, including water systems.]

12.0 GOALS

12.5.5. **Clean stormwater by natural processes prior to entering the storm drain system.**

In general, the Volcano Heights area drains to the southeast corner, Paseo del Norte, and the escarpment. Drainage ponds are required due to the limited capacity of the Piedras Marcadas arroyo. Where possible, alternatives to stormwater/sewer lines are preferred. Bioswale/linear ponds, as well as other natural treatments, particularly in the Park Edge Zone (VHET), perhaps in conjunction with or incorporated into the Park Edge Road, could add natural amenities to the area as well as improve stormwater quality.

13.0 POLICIES

13.0 POLICIES

13.1. Environment and Open Space: The following policies further goals found in **Section 12.1** starting on page 214.

13.1.1. The City Open Space Division should prioritize significant rock outcroppings, the archaeologically significant playa area, and double-loaded portions of the Park Edge road for acquisition or land swaps. Areas identified for acquisition should be reviewed by the Open Space Advisory Board for inclusion in the **Major Public Open Space** priority acquisition list.

13.1.2. Future open space acquisitions within the Plan area should be considered for future General Obligation Bonds.

13.1.3. Sensitive lands – whether rock outcrops or significant cultural, archaeological, volcanic, or geologic land – that cannot be or have not been purchased by City Open Space should be permanently protected privately through either a Transfer of Development Rights, a Conservation Easement, or replatting as **private open space**. [See **Appendix D** for more about options for private preservation options.]

The costs of archaeological resource mitigation tend to be much higher than the alternative of in-place avoidance. The protection of archaeological sites through avoidance is included in this Plan as an incentive for greater development density and height through the optional bonus height system as well as rock outcroppings counting double their square footage to satisfy either usable or detached open space requirements.

[See **Section 6.4** starting on page 111 and **Table 6.1** on page 112 for the bonus height system and **Section 9.5.11** starting on page 146 for the square footage incentive.]

13.1.4. Property owners should provide public access to **rock outcroppings** via nearby sidewalks and pedestrian walkways. Where such access is provided, the property owner should grant a public access easement that remains with the property in perpetuity. **Appendix D** offers additional options for private preservation options, including Conservations Easements, which may be eligible for tax rebates. These areas are excellent places to incorporate **water harvesting**, as coordinated and approved by the City Open Space Division and the City Hydrologist.

13.1.5. The City should adopt an ordinance to allow Transfer of Development Rights (TDR). This would allow property owners with **rock outcroppings** to “send” density to “receiving” properties where density is more appropriate. Similarly, property owners with multiple properties — some with rock outcroppings and some without — would be able to transfer development densities and height bonuses between properties.

13.1.6. Dedications of land to the City for **Major Public Open Space, detached open space**, and/or **parks** are preferred **abutting** the Petroglyph National Monument, **rock outcroppings**, multi-use trails, or parks. Dedications are subject to approval by City Parks and Recreation and/or Open Space Division.

- 13.1.7. The City should swap land it owns within Volcano Heights for any portions of properties rendered undevelopable by **Primary Streets**, particularly the Park Edge Road. Where a land swap is not possible, the City should purchase undevelopable remnants of land.
- 13.1.8. Open space areas should be considered for LID techniques. [See **Table 13.2** and **Exhibit 13.5** on page 242.]
- 13.1.9. Infrastructure and development projects within the Escarpment Transition zone should be designed to minimize potential negative impacts to the Petroglyph National Monument. Construction activities should be carefully planned in consultation with the City Open Space Division and the National Park Service to minimize fugitive dust and vibration impact on the Monument and ensure compliance with standards and requirements.
- 13.1.10. Protecting the area's natural resources, including the Escarpment within the Petroglyph National Monument, is important while balancing the opportunity to create an urban district with an identity, character, and sense of place inextricably linked to the volcanic landscape. For development within the Escarpment Transition zone, abutting archaeological sites, or adjacent to Major Public Open Space, the City Open Space Division should coordinate with property owners and City Planning staff to create a process to sufficiently document existing conditions on the subject property as well as the nearby natural resource to enable effective monitoring, implementation, and oversight of construction activities – particularly blasting.
- 13.2. Economic Development:** The following policies further goals found in **Section 12.2** starting on page 215.
 - 13.2.1. The City should designate all but the Transition zones as the Volcano Heights Major Activity Center, including updating the Centers and Corridors map in the Albuquerque-Bernalillo County Comprehensive Plan.
 - 13.2.2. Economic development should include a range of retail, office, and light manufacturing. Non-residential development should include goods and services for regional and local residents and visitors.
 - 13.2.3. Business recruitment should focus on employment opportunities that provide livable wages and high-quality work environments.
 - 13.2.4. Mixed-use development should include opportunities for retail and services for local and nearby residents.
 - 13.2.5. Innovative businesses, green businesses, and new businesses that add employment opportunities, as opposed to cannibalizing commercial uses in other areas, should receive priority consideration for public-private partnerships, matching funds, and leeway in standards within the range acceptable as Minor or Major per **Table 3.2** and **Table 3.3** starting on page 31.
 - 13.2.6. City Economic Development should work with property owners, prospective businesses, and the Double Eagle Airport to recruit businesses for Volcano Heights.

13.0 POLICIES

13.2.7. The most up-to-date and forward-thinking communications infrastructure should be incorporated throughout Volcano Heights to allow maximum flexibility for prospective businesses and industries.

13.3. Transportation: The following policies further goals found in **Section 12.3** starting on page 217.

These transportation policies provide guidance for the development of a transportation network within the Volcano Heights Plan area. The goal is to facilitate a range of transportation options that support lifestyle choices and quality of life for people of all ages and abilities. This Plan advocates strategies to create a street network that distributes local traffic efficiently and maintains regional traffic movement through the Plan area. This street network is multi-modal, serving automobiles but also providing bicycle facilities and pedestrian amenities to serve commuters as well as recreational users, and all modes are linked to public transit routes. The intent is to create a transportation system that provides easy access to where people live, work, and play. This Plan proposes and defines a network of **Primary Streets**, for which a transportation assessment was conducted in 2012. [See **Appendix C**].

These policies are intended to support and implement goals set by the Mid-Region Council of Governments (MRCOG) to shift the mode of travel to mitigate congestion at river crossings, promote the integration of alternative modes of transportation, and encourage higher-density land use in appropriate areas oriented to multiple modes of traffic, including pedestrians, transit, and cyclists.

The designated Major Activity Center (MAC) in the Volcano Heights incorporates the higher-densities and mixed land uses that can promote walkability and ultimately support frequent high-capacity transit such as **BRT**. This type of development can also play a role in preserving open space and views and buffering existing lower-density areas from higher-activity areas.

Well-connected, context-sensitive local street systems work together with the form-based zoning to shorten block lengths, provide a variety of transportation options for commuters and for resident's daily needs, reduce traffic on arterial roadways, and support transit, bicycling, and walking as viable modes of travel.

Linking land use and transportation planning to investment is a key factor in managing congestion and improving the balance of housing and jobs west of the Rio Grande. More specifically, higher-density **mixed use** development in appropriate locations and densities is necessary to support vital local communities and a cost-effective transportation system for all modes. The Volcano Heights MAC is intended to provide a center of activity to address transportation needs throughout the metropolitan area.

Intensive uses and population density are critical to successful transit. In return, transit will play a vital role in reducing regional traffic congestion, but to be widely used it must be fast, frequent, and reliable. This Plan's emphasis on walkability and urban development will help to make more frequent transit service viable.

13.0 POLICIES

[Amended November 5, 2014]

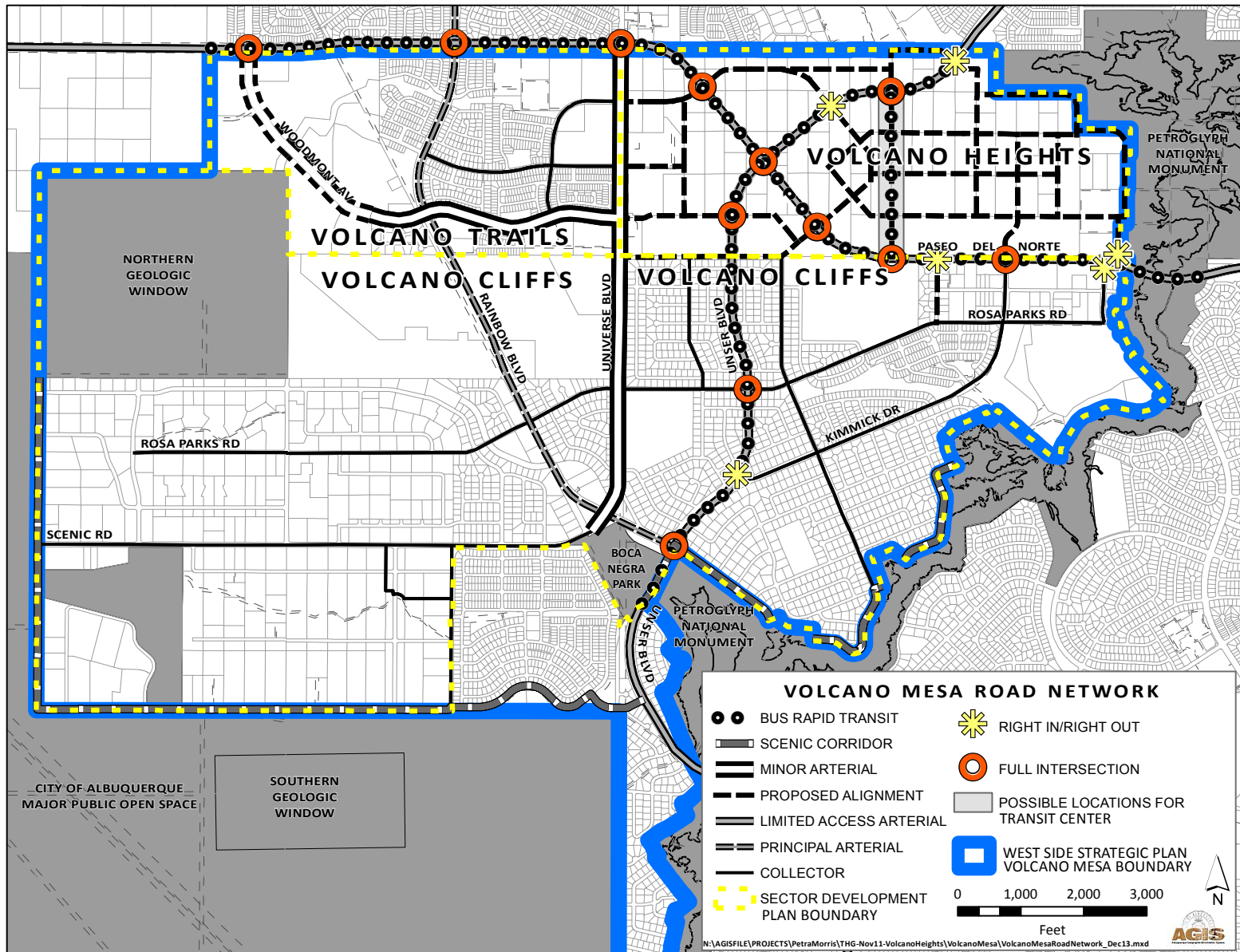

EXHIBIT 13.1 – VOLCANO MESA ROAD NETWORK

13.0 POLICIES

MRCOG stresses the connection between land use and transportation planning in the 2035 MTP. In conjunction with the MTP, the Metropolitan Transportation Board established mode share goals of 10% of river crossing trips to be completed by transit by 2025 and 20% by 2035. MRCOG views transit-supportive developments such as Volcano Heights to be critical towards ensuring regional mobility and achieving regional mode share goals.

The **BRT** system proposed for the area in the future incorporates dedicated bus lanes and emerging technologies to make travel times competitive with the car. MRCOG is conducting a high-capacity transit study as of 2013. Potential alignments identified for high-capacity transit routes include Unser Boulevard and Paseo del Norte in the Volcano Mesa area and extend to the Journal Center / North I-25 area and ultimately to the UNM/CNM area and downtown. High-capacity transit would transport area residents and workers to and from the Plan area and established West Side communities, as well as provide mass transit to central Albuquerque and jobs in the I-25 corridor as well as other employment and activity centers east of the Rio Grande. This route alternative responds to the projected growth throughout the region's West Side and the pressure that growth would impose on the roadway network and river crossings. Rio Metro is analyzing the potential for compact and transit-oriented development to increase ridership on West Side transit routes relative to existing conditions as part of the transit study.

MRCOG will seek federal and other funding sources to implement the route that is ultimately selected as the locally-preferred alternative. The timeframe for implementation of service through Volcano Heights is dependent in part upon the approval and realization of the Volcano Heights SDP.

Developing walkable urban centers is key to ensuring pedestrian safety. The Federal Highway Administration (FHWA) recently designated Albuquerque as a Pedestrian Safety Focus City because of the high rate of pedestrian fatalities. Focus cities were identified based on more than 20 average annual pedestrian fatalities or a pedestrian fatality rate greater than 2.33 per 100,000 population. The **FHWA** will provide technical assistance to conduct training on street designs for pedestrian safety, including a Road Safety Audit in locations that have a high number of pedestrian involved crashes. A Road Safety Audit looks at all modes using the street, the current design and signalization, and the location of transit to provide short- and long-term recommendations for improvement.

MRCOG has conducted a street connectivity analysis of developed areas in the region. The analysis shows that a well-connected street network has lower levels of congestion than a less-connected network. The more connected the surrounding street network is, the less congestion there is on major arterials. The connectivity analysis is currently done by calculating the number of intersections per mile. Enhanced street connectivity can disperse traffic, enhance safety, provide alternative emergency routes, and support the use of alternative transportation modes to the single occupancy vehicle.

13.3.1. **Regionally Significant Roads:** Paseo del Norte and Unser Boulevard through the Plan area are vital to the realization of the Major Activity Center and associated benefits of job creation and alleviation of regional traffic congestion. Both also serve a vital regional transportation function and will continue to serve existing and future development beyond the Plan area. The cross sections in this Plan are specifically designed to serve both regional transportation needs and the proposed multi-modal urban development pattern envisioned by the Plan.

- (i) **Funding for Construction:** As such, the City should prioritize and attempt to secure funding to help with the construction of Paseo del Norte and Unser Boulevard within the Plan area per the cross sections within this Plan. Segments that are necessary for implementing enhanced transit service should be prioritized for funding.
- (ii) **Grade-separated Interchange:** Per The Mid-Region Metropolitan Planning Organization Transportation Coordinating Committee (TCC) Resolution R-13-03 [See **Appendix C**], the intersection of these two regionally significant roads should be reviewed for the construction of a grade separated interchange at such time as traffic congestion and development conditions warrant.

Until this time, the intersection should be constructed as a traditional at-grade, signalized intersection. At such time as a grade-separated interchange is recommended by the TCC, it should be designed to complement this urban, multimodal area and minimize negative impacts to the surrounding land uses, trails, and sensitive lands, specifically:

- a. The interchange should be designed with the smallest footprint that works operationally for the defined design horizon, and
 - b. The interchange should incorporate the best practices for urban, multimodal interchanges, in order to support safe crossings for all modes of transportation in all directions.
- (iii) **Limited-access Intersections:** In order to protect the regional function of these roads, all access to new development in Volcano Heights should be from streets connected to the approved intersections on Paseo del Norte and Unser Boulevard shown in **Exhibit 10.3** on page 169. Streets providing access to new development may be either **Primary** or **Secondary Streets** as most appropriate.
- a. For **Primary Street** locations and designations, see **Exhibit 10.1** on page 165.
 - b. For **Primary Street** cross sections and design standards, see **Section 10.6** starting on page 173.
 - c. For **Secondary Street** design standards, see **Section 10.7.3** starting on page 200.

13.0 POLICIES

13.3.2. **Transit System:** The transit system in the Volcano Mesa area should serve three significant corridors:

- (i) east-west along Paseo Del Norte;
- (ii) north-south along Unser Boulevard, and
- (iii) southeast-northwest along Rainbow Boulevard.

13.3.3. **Transit Network**

- (i) The **Primary Street** network and Secondary Streets should form a grid as much as possible in order to facilitate the movement of transit vehicles, pedestrian access to transit stops, and the dispersion of automobile traffic away from potential congestion points.
- (ii) Transit stops and/or stations should be located to maximize the number of residents and workers within a one-quarter mile walk to a stop or station.
- (iii) On these transit routes, crossings of a limited-access arterial will need special design treatment to ensure safe and easy pedestrian crossings. Possible treatments include pedestrian delays, raised center medians (pedestrian refuges), clearly identified pedestrian crossings, pedestrian yield signage, reduced curb radii, and pedestrian starts or leading pedestrian intervals, which give pedestrians authority to start crossing before non-yielding, right-turning vehicles.
- (iv) Transit stops or stations should be placed on **'A' Streets adjacent** to planned retail conveniences, schools, and public amenities.

- (v) Reasonably direct auto routes and acceptable system-wide travel speeds should be maintained.

13.3.4. **Transit Center:** A major transit center should be located in the Town Center **abutting** the Transit Boulevard to serve the Paseo del Norte and Unser Boulevard corridors. The Transit Boulevard should connect with both Unser Boulevard and Paseo del Norte at signalized intersections. A secondary transit center should be located south and west of the Neighborhood Activity Center proposed near Rainbow Boulevard and Hielo Road in the Volcano Cliffs Sector Development Plan area.

13.3.5. **Long-Range Transportation System Guidelines**

- (i) The policies and regulations in this Plan should be updated to conform with MRCOG's Long Range Transportation System Guidelines [formerly called Future Albuquerque Area Bikeways & Streets or FAABS Guidelines], which will be an addendum to the Metropolitan Transportation Plan, expected in 2013. This document will contain guidelines on roadway design that are driven by land use context, are multi-modal, and that provide a flexible range of right-of-way and design options.

- (ii) The Long-Range Transportation System Map should designate Unser Boulevard and Paseo del Norte as suitable for High Capacity Transit. The plan should be amended to be consistent with recommendations adopted with this Sector Development Plan and updated as transit planning evolves.
 - a. The ultimate roadway design recommendations for Unser Boulevard and Paseo del Norte in this Plan incorporate **BRT** capacity in order to design them as suitable for High Capacity Transit.
 - a. Transit improvements may be phased, and interim routing may be different from the ultimate routes in some locations.
 - a. If high-capacity transit is determined to be infeasible, the City should consider amending this Plan to revise cross sections to accommodate different conditions. [See **Section 3.3** starting on page 34 for the process to amend this Plan.]
- 13.3.6. **Transit Center and BRT/HOV Lanes:** Travel lanes dedicated solely to buses and other high-occupancy vehicles (HOVs) reduce travel times for those who carpool or use transit.
- (i) Paseo del Norte and Unser Boulevard should be designed to accommodate **BRT/HOV** travel lanes.
 - (ii) Transfer between **BRT** routes and local buses should occur at a Transit Center maintained near the center of Volcano Heights to enhance its pedestrian and locational advantages.
 - (iii) Beginning 500 feet before intersections on Paseo del Norte and Unser and any other potential station locations, a minimum of 36 feet in the rights-of-way should be provided on **BRT** routes for **BRT** lanes and station platforms.
 - (iv) The final location and configuration of **BRT** and **HOV** lanes will be determined during the roadway design process, as well as from findings and recommendations from the MRCOG High-Capacity Transit study for Paseo del Norte expected in 2013.

13.0 POLICIES

13.3.7. **Transit Center and Transit Stop Design:** The approach to the Transit Center and transit stops should offer direct pedestrian routes and be tree-lined and barrier free for safe, efficient, and attractive pedestrian access. The Transit Center and transit stops should be designed as prominent focal points, offering well-lit shelters that provide shade and are within or **adjacent** to **plazas** or other civic features. Shelters may be incorporated within the architecture of **adjacent** buildings or through the use of arcades or durable shade structures. Transit route and system maps should be displayed at all stops. Bicycle storage racks should be located at major transit stops.

- (i) **Transit-Oriented Development:** In deciding Transit Station and transit stop locations, preference should be given to locations with transit-supportive uses such as high-density, mixed-income residential developments and employment centers in order to attain and sustain high transit ridership. These uses should predominate within a quarter mile of transit stops. Transit system policies should emphasize more frequent service along high-density corridors.
- (ii) **Convenience and Access:** Pedestrian routes to transit stops should be reasonably direct (along streets and/or off-street paths); circuitous routes should be avoided. [See **Exhibit 13.1** for an example illustration.] Transit stops should be placed on **‘A’ Streets** near retail conveniences and community amenities. Multiple stage crossings for pedestrians should be provided at transit stops for safe crossing of wide arterials by pedestrians of all abilities and ages.
- (iii) **Signal Preference:** To improve travel times by transit, light signals in the Volcano Heights area should incorporate signal-preferencing technology such as “queue jumping” with a dedicated lane, or signal interruptions, to give buses priority at intersections.
- (iv) **Pre-boarding Fare Systems:** Transit should incorporate technology that allows bus fares to be paid prior to boarding, thereby greatly reducing boarding and transit travel times.

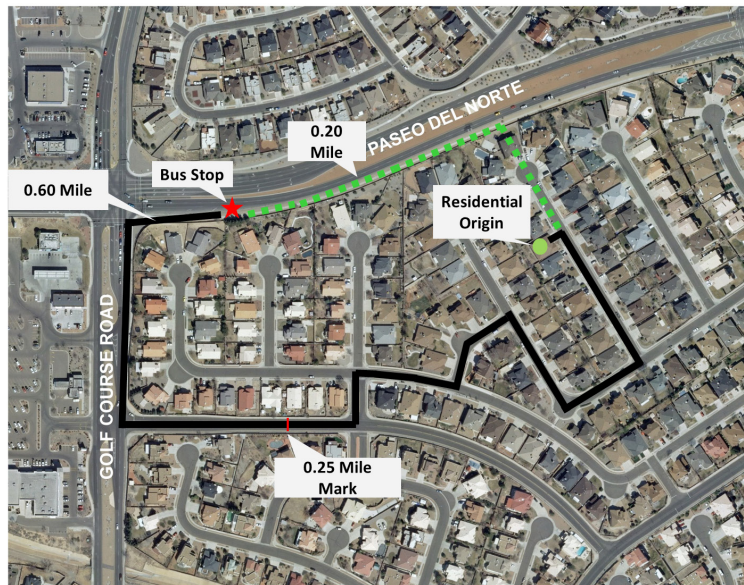

EXHIBIT 13.1 – CIRCUITOUS VS. DIRECT PEDESTRIAN ROUTES TO TRANSIT STOPS

13.3.8. **Transportation Demand Management (TDM) Plans:** Major employers should consider implementing Transportation Demand Management (TDM) strategies to provide alternatives to the use of single-occupancy vehicles. TDM offers incentives for ridesharing, transit use, bicycling, and walking. Incentives may include reduced parking requirements, reduced development fees, development intensity bonuses, and/or the creation of transportation management associations to coordinate efforts among multiple users in the same area.

13.3.9. **Transportation Agency and Plan Coordination**

- (i) As development occurs, all transportation modes should be integrated, which will require coordination among property owners, City **DMD**, ABQ RIDE, MRCOG, and the MRMPO. Roadways on MRCOG’s Long Range Major Street Plan must include appropriate access management strategies, which also requires coordination across transportation agencies.
- (ii) New **Primary Streets** should be added to the functional classification system in the **FAABS**.
- (iii) ABQ RIDE should coordinate with MRCOG and property owners to identify a short-term Park & Ride facility and Long-term Transit Center on the Transit Boulevard within the Volcano Heights Town Center.
- (iv) The City **DMD** should work with MRCOG and constituent jurisdictions to remove and/or alter truck restrictions on Unser Boulevard as established by R-455.

Other provisions in that resolution, relating to road design, character of the roadway as a boulevard with wide median, etc., should remain.

13.3.10. **Roadway Design**

- (i) Roads in Volcano Heights should follow best practices for multi-modal, urban streets. Excellent sources include Context Sensitive Design and Context Sensitive Solutions, as defined by the Federal Highway Administration, the Institute of Transportation Engineer’s “Designing Walkable Urban Thoroughfares: A Context Sensitive Approach, An ITE Recommended Practice.” Local sources include the New Mexico Department of Transportation’s “Guide to Context Sensitive Solutions” and “New Mexico Architectural and Visual Quality Design Guidelines for Context Sensitive Design and Context Sensitive Solutions.”
- (ii) Bicycle facilities, including on-street bicycle lanes and multi-use trails, should be designed and developed to meet safety considerations as provided in the Institute for Transportation Engineers (ITE) or American Association of State Highway Transportation Officials (AASHTO) standards.
- (iii) Roadways should be sited and designed to minimize negative impact on views from within the Plan area to the Sandia Mountains on the east.

[Amended November 5, 2014]

13.0 POLICIES

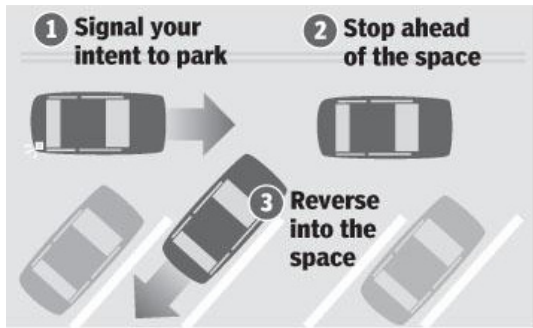
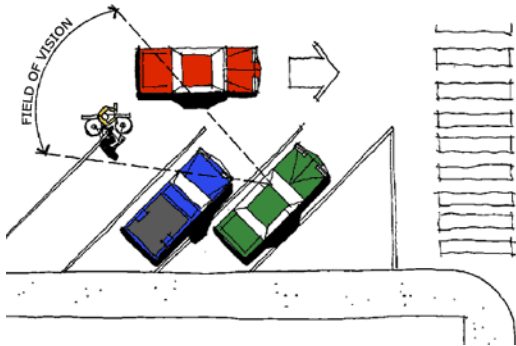

Roberto Villalpando AMERICAN-STATESMAN

EXHIBIT 13.2 – REVERSE-ANGLE PARKING EXAMPLES

- (iv) The Park Edge road next to the Petroglyph National Monument should be single-loaded wherever possible. The National Park Service and the City Open Space Division prefer this edge treatment as the boundary and the transition between Open Space and development in order to enhance public safety by allowing easier patrolling, passive surveillance via more “eyes on the street,” and improved access for emergency response. [See **Section 10.6.8** starting on page 195 for design standards and cross sections.]
- (v) Roadways designated as transit corridors should be designed to best accommodate transit vehicles, pedestrians, and bicycles. [See **Section 13.3.3.iii** in this Plan for more details.]
- (vi) Roadways should be designed to provide bicycle facilities and safe multiple-stage crossings for pedestrians at transit stops and for crossing wide arterials.
- (vii) Street furniture, bike racks, and pedestrian amenities such as benches and trash receptacles should be placed along **‘A’ Streets**. Maintenance is the responsibility of the private owner and may shared and/or coordinated through a private mechanism such as a **Business Improvement District (BID)**.
- (viii) Retail streets should be lined with a single type of tree or a coordinated palette of trees. On residential streets, street tree species should be consistent within a given street but may vary from street to street.
- (ix) Streets should be designed for all modes of transportation. On-street parking serves retail and other uses, while providing traffic calming that enhances safety and enjoyment for pedestrians and cyclists. Where permitted by available **ROW**, reverse-angle parking should be used on **‘A’ Streets** as the preferred parking arrangement, as it provides the best sightlines for drivers to see cyclists. [See **Exhibit 13.2.**] Reverse-angle parking generally requires 16-18 feet for stalls.

13.0 POLICIES

13.3.11. Roundabouts

- (i) Roundabouts offer significant potential benefits that warrant their consideration when a traffic control device is needed. They have been found to reduce congestion, pollution, and fuel use due to fewer conflict points, resulting in fewer stops and accelerations, fewer delays during regular and peak driving times, and less time idling. [See **Exhibit 13.3** for diagrams illustrating reduced conflict points.] There are also cost advantages, including eliminating the need for an expensive traffic signal or power service and the potential reduced need for pavement compared to a traditional intersection. In addition, some roundabouts require less right-of-way than a traditional intersection. Roundabouts also contribute to a high-quality built environment, providing wayfinding and placemaking benefits. Lastly, roundabouts can function more quietly and safely for all modes of transportation, which can also reduce costs associated with patrol and emergency response.
- (ii) Roundabouts are encouraged where warranted by traffic flow as defined by MUTCD criteria, particularly in order to avoid rock outcroppings. Care should be taken to ensure connectivity and safety for all modes of transportation. The criteria to be used for selecting a roundabout over other forms of intersection control such as signals or stop signs include, but are not limited to:

- a. Safety improvements, such as locations with high accident rates associated with conflicts that would be reduced or eliminated with roundabouts;
- b. Operational improvements, such as locations where a roundabout would provide better performance than stop signs or traffic signals;
- c. Traffic calming, appropriate for traffic circles on local street intersections;
- d. Community enhancement, appropriate as a gateway treatment to convey a change in environment or land use; and/or
- e. Special situations, appropriate in areas where unique alignment and/or geometric constraints make it impractical to use traditional traffic control modes.

Typical Intersection

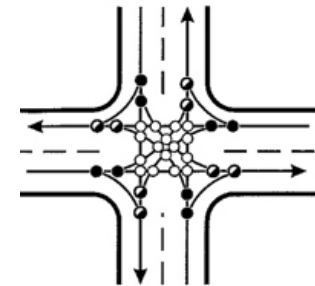

Conflict Points:

● Diverging	8
◐ Merging	8
○ Crossing	16
Total: 32	

Typical Single-lane Roundabout

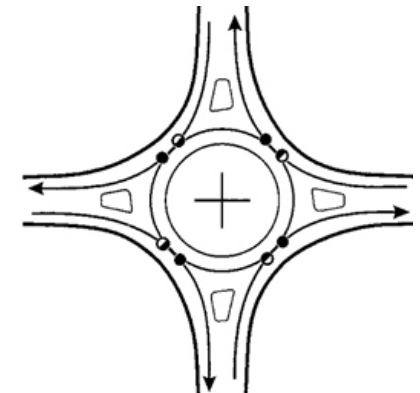

Conflict Points:

● Diverging	4
◐ Merging	4
○ Crossing	0
Total: 8	

Source: Federal Highway Administration

13.0 POLICIES

13.3.12. Street Connectivity

- (i) As development occurs, streets should maintain high connectivity for pedestrians, cyclists, and vehicles to provide a variety of safe, viable transportation options. A well-connected road or path network has many short links, numerous intersections, and minimal dead-ends. New roads, pedestrian walkways, and bicycle facilities added to serve new projects should improve connectivity. As connectivity increases, travel distances decrease and route options increase, allowing more direct travel between destinations.
- (ii) As development occurs surrounding Paseo del Norte and Unser Boulevard, grade-separated crossings and/or special signalization for pedestrians and cyclists should be considered to improve access to support land uses as well as improve safety for all modes of transportation.
- (iii) Property owners, developers, and the City should coordinate with MRCOG to identify and plan new thoroughfares in the area. Streets identified as collectors within the Volcano Heights Town Center and throughout residential subdivisions should be able to accommodate circulator buses and/or shuttles that could connect with **BRT** stations and other transit infrastructure.

13.3.13. Street Maintenance

- (i) New through roads should be public rights-of-way. If a property owner wants a road to remain private, and the City agrees, then the road should be built to public standards, and a public access easement will need to be granted on the private road. Public ROW is maintained by the City. Private roads, even those with public access easements, are maintained by the owner.
- (ii) **Primary Streets** should be public rights-of-way.
- (iii) Alleys that connect and serve multiple properties should be public rights-of-way. If they are internal to a site or project and are used only for deliveries, garbage pick-up, etc., then they may remain private. The City maintains **alleys** that are public rights-of-way, but only for drainage and filling in large holes. Weeds and any surfacing improvements are the responsibility of the **abutting** property owners.

13.3.14. Bicycle and Multi-use Trail Network

- (i) Existing plans for regional trails within the Volcano Mesa area should be implemented as funding resources become available. Please refer to the Rank 2 Trails and Bikeways Facilities Plan and the Rank 2 West Side Strategic Plan for more information on the area-wide trail network.
- (ii) Because of the checkerboard property ownership, this Plan does not specifically recommend any new trails within Volcano Heights. [See **Appendix A** for existing plans for regional trail locations within the Volcano Heights area.]
- (iii) If property owners wish to collaborate to build a private trail within Volcano Heights, this may be done through the subdivision or TIDD/SAD/PID process. This trail should be privately constructed and maintained through a **property owners association, merchants association, or BID** that can manage maintenance requirements, carry liability, and assure an ongoing source of funds. Any such trail should be coordinated with City Parks and Recreation and built according to City standards. Preference should be given to locations that connect **rock outcroppings** and **sensitive lands**; follow arterial streets; or provide access to existing trails, **Major Public Open Space**, parks, or recreational areas.
- (iv) Where bike lanes are included in a street cross section, bike lane widths should not exceed 7 feet to minimize the potential for misuse as a motor vehicle travel lane. In addition to the bike lane, a striped bicycle buffer of no less than 2 feet wide should also be included to improve safety for cyclists and motorists. Bicycle lanes plus buffer placed next to on-street parking should be wide enough to allow bicyclists to avoid open car doors without having to enter motor vehicle lanes.

13.0 POLICIES

13.4. Land Use and Design: The following policies further goals found in **Section 12.4** starting on page 218.

13.4.1. Replatting for Properties with Multiple Zones: Properties designated as more than one zone should be replatted to have no more than one character zone per lot.

13.4.2. Character Zones

- (i) High-density, mixed-income developments are most appropriate in the Town Center and Village Center zones, particularly because these are the most likely areas to be served by transit and can best support efficient transit service.

- (ii) Developments with high employment should be located in the Town Center and/or within a quarter mile of the Transit Boulevard as measured by existing or proposed pedestrian connections (i.e. not simply a radius).
- (iii) Development within the Town Center and Village Center zones should be the most urban, compact, and walkable developments, with high-quality pedestrian amenities and lively street activity.
- (iv) Regional retail with large areas of surface parking and auto-related uses are most appropriate in the Regional Center zone because of its proximity to Paseo del Norte and Unser Boulevard, the key regional vehicle facilities within the Plan area.
- (v) Medium-density and medium-intensity developments are most appropriate in the Mixed Use zone.
- (vi) Campus-like office parks are most appropriate in Mixed Use and Regional Center zones.
- (vii) Low-density and low-intensity developments are most appropriate in Transition zones.
- (viii) Development within the Escarpment Transition zone should honor, respect, and enhance the unique geological, cultural, historical, and anthropological context of the Petroglyph National Monument.
- (ix) Development within the Neighborhood Transition zone should respect and enhance the existing single-family neighborhoods nearby.

TABLE 13.1 – APPROPRIATE DENSITY AND LAND USE BY ZONE

CHARACTER ZONE		DENSITY / INTENSITY	HIGHLY COMPATIBLE LAND USES
CENTER ZONES			
	Town Center	Highest	Corporate headquarters, urban movie theaters and museums, entertainment
	Regional Center	High	Lifestyle centers, campus office parks, auto stores
	Village Center	High	Corner retail, live/work units
MIXED USE ZONES			
	Mixed Use	Medium	Campus office parks, multifamily units
TRANSITION ZONES			
	Escarpment Transition	Low	Single-family residential, small-scale office and retail, destination resort, recreation-based businesses
	Neighborhood Transition	Low	Single-family residential, small-scale office and retail

13.4.3. **Pedestrian Interest:** Development in all zones should contribute to a high-quality built environment, with particular emphasis on providing visual interest at the scale of the pedestrian in order to create a walkable district for residents, employees, and visitors.

- (i) Large expanses of wall or building façade should include a variety of building materials, colors, and/or openings to break up the plane.
- (ii) **Civic spaces** should include seating and interactive elements accessible to the public.

13.4.4. **Entrances**

- (i) Service entrances should be located to minimize visual, noise, olfactory, and air quality impacts on surrounding uses.
- (ii) Pedestrian entrances for multi-family development and non-residential development should be located to provide the most direct access to nearby transit stops.

13.4.5. **Sidewalk Locations:** The location of sidewalks shall reflect the desired character and density of the surrounding land uses. In Center and Mixed-Use Zones, sidewalks are essential to creating a vibrant, pedestrian lifestyle.

13.4.6. **Single-family Buffers:** Single-family residences should be buffered to the extent possible from the most intense uses. Landscape and screening buffers are adequate for buffering single-family residences from multifamily, light retail, and small-scale office developments. Multifamily or small-scale retail and office developments are appropriate uses to buffer single-family residences from heavier commercial or manufacturing uses.

13.4.7. **Building Placement:** Site development standards, specifically building frontage standards, are designed to create high-quality pedestrian environments to support the Major Activity Center. As the area develops over time, the buildings will create an urban fabric of corridors lined with buildings. The frontage requirements are carefully designed to allow each site to increase in density over time, as surface parking transitions to structured parking lined with retail buildings, as shown in **Exhibit 13.4**, for example.

13.0 POLICIES

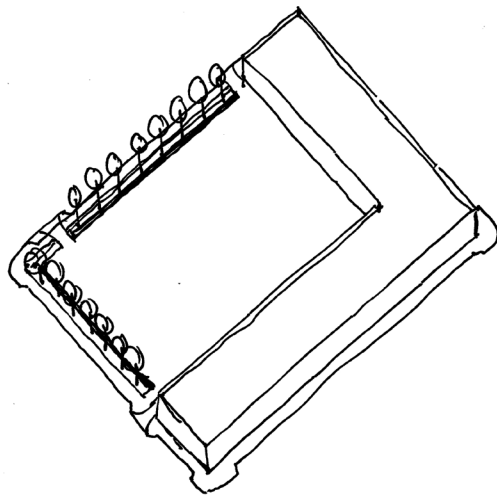
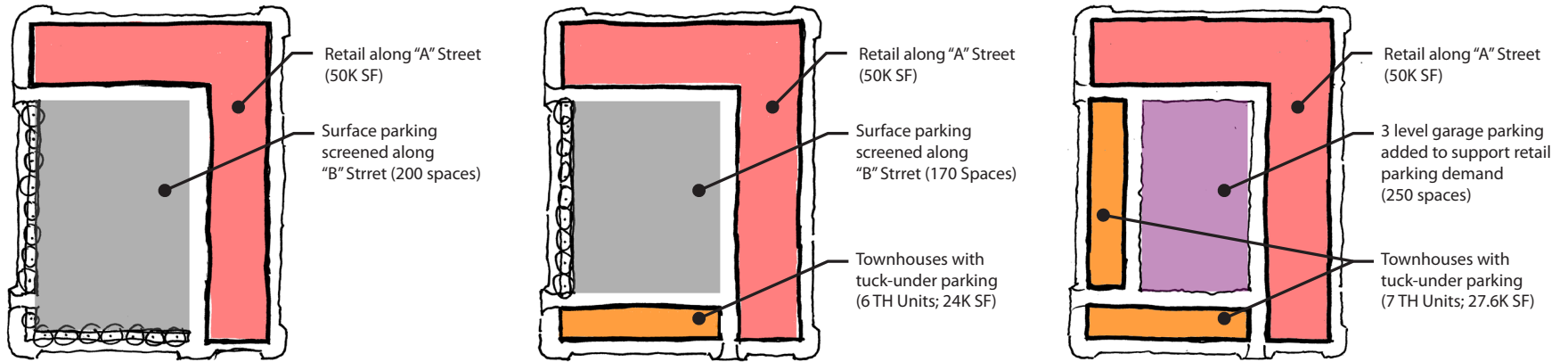

Stage 1

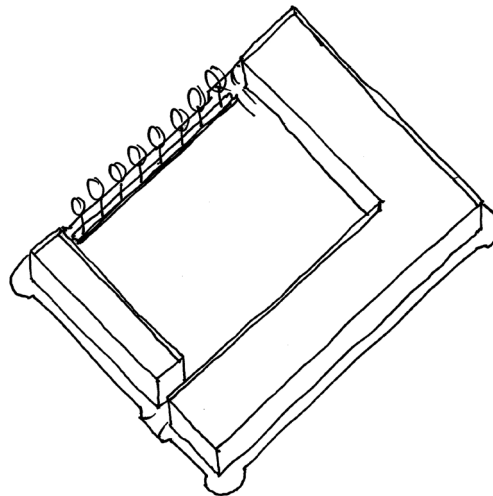

Stage 2

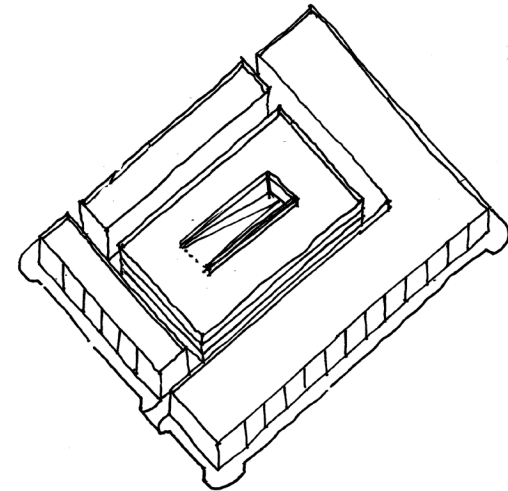

Final

Gateway
Planning Group

EXHIBIT 13.4 – SAMPLE TRANSITION TO DENSITY OVER TIME

13.4.8. **Building Orientation**

- (i) Buildings should be designed and sited to maximize solar gain and minimize solar impact on **abutting** properties.
- (ii) Buildings should be designed and sited to minimize negative impact on views from within the Plan area to the Sandia Mountains on the east.
- (iii) Buildings should be designed and sited to minimize negative visual impact on views from across the Rio Grande west toward the Volcanoes.

13.4.9. **Coordination and Maintenance:** Property owners should coordinate development, maintenance costs and responsibilities, and liability for publicly accessible private amenities either through forming a **BID** or other private mechanism.

13.5. Infrastructure: The following policies further goals found in **Section 12.5 starting on page 221**.

13.5.1. **New Infrastructure**

- (i) The cost of infrastructure required to service new development is the responsibility of the developer, unless coordinated with other property owners as part of a master development or other mechanism to leverage investment, such as a TIDD, SAD, or PID.
- (ii) Infrastructure planning should be coordinated along corridors and across property owners.

- (iii) The cost of backbone infrastructure that can support development throughout the Plan area should be coordinated across property owners, whether through private development agreements, a master developer, or a formal TIDD, SAD, or PID.

13.5.2. **Electrical Utilities**

- (i) Electric infrastructure is planned and constructed in response to new development. New electric transmission lines and multiple substations will be needed within the Plan area to provide electric service once regional employment center development occurs. Substations typically require one- to two-acre parcels of land. It may be necessary for substations to be located near the electric load in the Plan area. Transmission lines should be located along arterial streets, major drainage channels, non-residential collector streets and other potential corridors as directed by the Facility Plan: Electric System Transmission and Generation (2010-2020).
- (ii) To serve future development in Volcano Heights, an additional transformer is expected to be needed. Typically, transformers require approximately two (2) acres. Property owners should consider donating or pooling land for this purpose, preferably close to the Town Center.

13.0 POLICIES

TABLE 13.2 – LOCATIONS APPROPRIATE FOR LOW-IMPACT DESIGN (LID) BY SCALE

MICRO	
1	Tree wells
2	Medians
3	Parking lot islands
4	Pocket parks
5	Backyard/front yard ponds and landscape areas
6	Parkway between curb and sidewalk
7	Area behind sidewalk
8	Unused or rarely used areas of parking lots
LOCAL	
1	Small parks and open spaces
2	On-site drainage ponds retrofit for “first flush” and floatables treatment
3	Re-graded parking lot landscape areas (use speed bumps/dips as diversions)
4	Channel tributary entrances
5	Subdivision scale detention basins
6	Subdivision entry features
REGIONAL	
1	Regional detention basins
2	Pump stations
3	Pump station discharges into Rio Grande
4	Regional parks and open space
5	Diversion channel and arroyo outfalls to river

13.5.3. Rainwater Management

- (i) Developments should incorporate Low Impact Design (LID) techniques wherever possible and appropriate. [See **Table 13.2**, **Table 13.3**, and **Exhibit 13.5** in this Plan.]
- (ii) Property owners should consult and/or incorporate **AMAFCA’s** Drainage Master Plan for Volcano Heights, being drafted as of 2013, for key drainage infrastructure. [See **Section 14.2.5** starting on page 248.]
- (iii) Where possible, natural stormwater treatments, such as bioswales, linear ponds, etc., should be used to provide flood control and for stormwater quality.
- (iv) A bioswale/linear pond should be designed and incorporated into the median and/or eastern edge of the Park Edge Road. Such a pond, designed in consultation with the City Hydrologist, can help provide a preferred alternative to stormwater drains while helping to meet the City’s water quality goals. [See also **Section 10.6.8** starting on page 195 and **Goal 12.5.5** starting on page 222 in this Plan.]



Decorative Grill and Curb Cut



Permeable Paving



Parking Raingarden

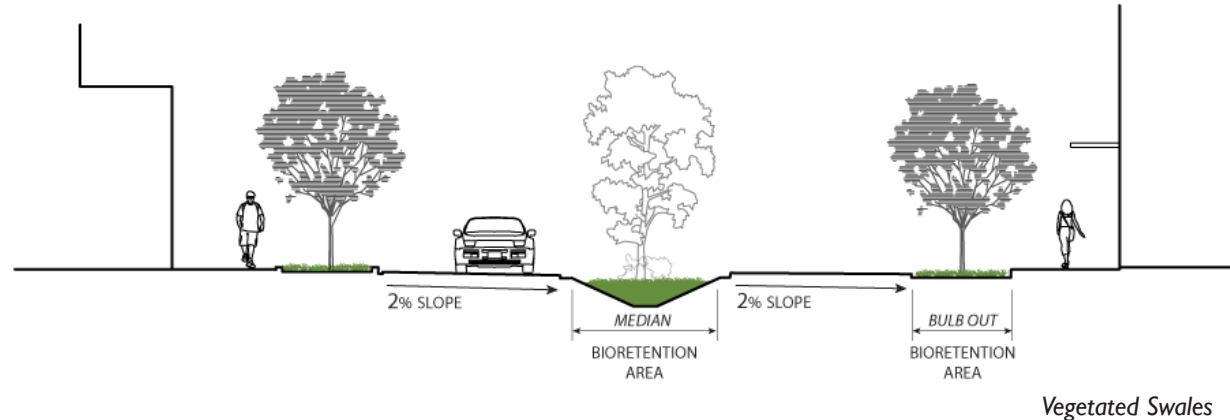

TABLE 13.3 – OBJECTIVES AND RECOMMENDATIONS FOR LID BY DESIGN ELEMENT

DESIGN ELEMENT	DESIGN OBJECTIVES AND RECOMMENDATIONS
Impervious Surfaces	Minimize the amount of directly connected impervious material. Transition to permeable material under parking areas and/or create breaks in impervious material with open curbs or flush-mount curbs that allow water to flow into landscaped areas.
Roadway Section	Roadway sections should be as open and as minimal as possible. Pedestrian zones should be separated from vehicular zones with a landscaped area bordered by open curbs or flush-mount curbs to allow for water flow.
Intersections	At large intersections, introduce a traffic circle designed to accept stormwater runoff and act as a landscaped bioretention area. At all intersections, minimize turning radii to slow traffic and reduce paved area.
Looped Turnaround	Where possible along the corridor, cluster development and design a looped turnaround for access. The center of the loop can be bordered by flush-mount curbs and act as a landscaped bioretention area.
Driveways	Where possible, share driveways and transition to permeable pavement in the driveway.
Sidewalks	Slope/grade sidewalks horizontally so they drain toward landscaped areas.

13.0 POLICIES

- 13.5.4. **Water Improvements:** As of adoption of this Plan, the Albuquerque-Bernalillo County Water Utility Authority (ABCWUA) was reviewing a 2012 draft Northwest Service Area Integrated Infrastructure Plan for an area that includes Volcano Heights, which identifies the size of water transmission trunk lines, storage capacity, water treatment, and fire storage necessary to support development.
- (i) Increased demand within both the Corrales and Volcano Trunks will require additional treatment capacity at the wells within both these trunks.
 - (ii) Additional storage capacity (i.e. an additional water tank) may be needed to provide fire protection to new development within Volcano Heights. The ABCWUA will determine future storage requirements based on details as new development is proposed.
 - (iii) All necessary, required infrastructure improvements to provide water service to Volcano Heights will be constructed by the developer. This includes the internal distribution systems in the study area.
 - (iv) All new infrastructure must be built to ABCWUA standards before the Water Authority accepts the new infrastructure.
 - (v) As Volcano Heights is outside of the existing ABCWUA service area, all development will be assessed Water Supply Charges as well as Utility Expansion Charges. The Water Supply Charges relate to the acquisition of new water rights necessary to provide service outside of the defined ABCWUA service area.

13.5.5. **Wastewater Improvements**

- (i) All necessary, required infrastructure improvements to provide wastewater collection services to Volcano Heights will be constructed by the developer.
- (ii) All new infrastructure must be built to ABCWUA standards before the Water Authority accepts the new infrastructure.
- (iii) All collected waste water flows from the study area will outfall to the existing interceptor in the Paseo del Norte/Avenida de Jaimito Corridor. Extension of this line to the west from its current terminus (near Calle Norteña) will be required.

13.5.6. **ABCWUA Development Agreements**

- (i) All new water services within the study area will require the execution of a Development Agreement between the owner/developers and the ABCWUA before either water or wastewater service is provided.
- (ii) The Development Agreement will detail the extent of the required water and wastewater infrastructure that must be constructed before service is provided by the ABCWUA.
- (iii) The Development Agreement does not replace or supersede the development requirements of the City of Albuquerque as detailed in the Development Process Manual.

14.0 IMPLEMENTATION

14.0 IMPLEMENTATION

14.1. Priority Capital Improvement Projects

Development of the Volcano Heights Plan area and the Major Activity Center is expected to occur over a period of decades and will require a high level of infrastructure to attract high-quality development and **major employers**, as discussed further in the fiscal impact analysis in **Appendix E**.

The fiscal impact analysis estimates the potential for over \$150 million in additional development value from the mixed-use, walkable environment envisioned by this Plan and enabled by its zoning and design standards, in comparison to the more typical suburban development model, with its high initial investment but steep drop off in development value. Based on this analysis, the high initial investment needed to create a “sense of place” will more than be recovered by the long-term value as the area continues to increase in value over time.

As the fiscal impact analysis indicates, the potential for better outcomes is compelling, and the City should carefully consider how to invest in Volcano Heights’ success to reap the financial benefits, as well as the enhanced opportunities for economic development and placemaking, this model offers. By investing in appropriate catalytic improvements, the City can support a sustainable development model for Albuquerque and, in particular, the West Side.

Priority infrastructure includes, but is not limited to the following needs:

- 14.1.1. The **Primary Street** network, especially the Transit Boulevard through the Town Center and the loop road to provide access to Primary Streets surrounding the intersection of Paseo del Norte/ Unser Boulevard;
- 14.1.2. Complete buildout of Paseo del Norte and Unser Boulevard to the City’s required cross sections;
- 14.1.3. An internal, local road network to access residences and businesses and designed to meet **block size** requirements for each district;
- 14.1.4. Telecommunications and utility infrastructure;
- 14.1.5. Water, sewer and drainage infrastructure, including regional retention pond facilities, an additional water tank, and water source and water quality improvements;
- 14.1.6. Trails, bike facilities, and other recreational facilities;
- 14.1.7. **Civic spaces, parks and open space;** and
- 14.1.8. Transit facilities, including bus stops and a multi-modal transit center in Town Center serving proposed high-capacity transit.

14.2. Implementation Responsibilities

Though it is likely that some funding will be available for certain projects from the City, County, State and other regional agencies, the bulk of the cost for infrastructure in Volcano Heights is the responsibility of land owners and developers. Broad coordination among multiple land owners and robust financing mechanisms will be necessary for development.

14.2.1. Property Owners

- (i) Coordination – engagement of a master developer is recommended;
- (ii) Infrastructure costs;
- (iii) Development costs;
- (iv) Implementation of finance mechanisms, such as **Special Assessment Districts (SADs)** or **Tax Increment Development Districts (TIDD)**.

14.2.2. City of Albuquerque

- (i) Sector Development Plan
 - Development of land use and zoning regulations;
 - Development of design requirements;
 - Development and implementation of streamlined review process; and
 - Adoption and update of the Plan.
- (ii) Economic Development
 - Coordination among multiple jurisdictions;
 - Promotion of area and recruitment of business; and
 - Collaboration with businesses and development of incentives, such as Industrial Revenue Bonds.

- (iii) Department of Municipal Development
 - Coordination with agencies and private utilities to develop infrastructure in a timely manner;
 - Creation and evaluation of road cross-sections; and
 - Coordination to address truck restrictions within Volcano Heights.

14.2.3. State, County, Mid-Region Council of Governments

- (i) Transportation coordination, including approving an impending update of the Future Albuquerque Area Bikeways and Streets (FAABS) Plan to better coordinate transportation and land use;
- (ii) Adding Primary Street alignments to the Long Range Transportation System map;
- (iii) Reviewing a grade-separated interchange at Paseo/Unser when traffic and development conditions warrant; and
- (iv) Assistance with infrastructure costs where feasible.

14.2.4. Albuquerque-Bernalillo County Water Utility Authority (ABCWUA): Planning guidance to verify compliance with the ongoing ABCWUA Master Planning efforts.

14.0 IMPLEMENTATION

14.2.5. **Albuquerque Metropolitan Area Flood Control Authority (AMAFCA):** As of 2013, AMAFCA is preparing a Drainage Master Plan for the Volcano Heights Area. The Drainage Master Plan will identify the major drainage infrastructure needed in Volcano Heights, recommend a construction plan and schedule, and work through a mechanism with property owners to finance the infrastructure. All public and private stakeholders are encouraged to participate in the process.

14.3. Optional Financial Tools

City Ordinances allow for a variety of financial tools that enable rising property values from development to pay for infrastructure. Desired outcomes at Volcano Heights will likely require the use of one or more of the following methods:

14.3.1. **Special Assessment District (SAD):** Described in the Albuquerque Code of Ordinances, Section 6-8, **Special Assessment Districts (SADs)** involve an additional charge added to property taxes to fund necessary improvements in new subdivisions, such as drinking water and sewer lines, paving and other government services. SADs can be requested by a percentage of landowners in an area or imposed by a local government, and SAD revenues are used to pay back city general funds or service debts, such as bonds, incurred for infrastructure construction.

14.3.2. **Public Improvement District (PID):** Described in the Albuquerque Code of Ordinances, Section 6-9 and enabled by New Mexico Statute Section 5-11-1 to 5-11-27 NMSA 1978 (2001), **Public Improvement Districts** involve an additional charge added to property taxes to fund a broad array of improvements in a subdivision, ranging from roads and drainage to recreational facilities, trails, parks, public buildings, libraries and other amenities. Like SADs, PID revenues are used to pay back general funds or debts incurred for the construction of infrastructure. The City of Albuquerque currently requires unanimous vote of property owners to establish a PID, though state statutes allow PIDs to be created with $\frac{3}{4}$ of property owners in agreement.

14.3.3. **Tax Increment Development District (TIDD):** Described in the City of Albuquerque Code of Ordinances, Section 4-10, **Tax Increment Development Districts (TIDDs)** capture a portion of the increase in property and gross receipts taxes resulting from the area's development. Funds can be used to pay back debt on a range of projects similar to PIDs, including elaborate streetscapes like the urban boulevard, parks and trails, **civic spaces**, and other amenities. TIDDs are typically used for a large, master-planned development, rather than a single subdivision. Unlike other funding mechanisms, they do not impose new costs or taxes on property owners (except those incurred by rising property values caused by development). TIDD proceeds can also be used for ongoing maintenance and improvement of facilities.

TIDDs require major coordination among property owners to apply for and maintain districts, issue bonds, and manage revenues and bond payment.

14.3.4. Public/Private Tax Rebate Agreement: Similar to a TIDD, this type of agreement allows for cities, counties, and other taxing entities to enter into agreements with developers that let developers obtain rebates for infrastructure in return for development that meets standards set by the affected governments for density, walkability, sustainability, etc. Under this type of public/private partnership, the rebates can only be requested after the development has been completed as agreed upon and new property or sales tax revenues have been generated there for a set time period. Such an arrangement can allow rebates of tax revenues for a flexible range of infrastructure improvements, such as streets and utilities, but unlike TIDDs, developers must pay those costs upfront themselves – the agreement cannot be collateralized to allow bonding or other debt acquisition based on expected rebates. At least one such agreement has been made in New Mexico – a project in Rio Rancho whose developer may request up to \$2.8 million in rebates for infrastructure costs from gross-receipts (sales) taxes generated on site, after the development is complete and has been in use long enough that those revenues have been collected by the New Mexico Taxation and Revenue Department.

14.4. Amending this Sector Development Plan: Changes to the text, graphics, or zone map shall be per City Zoning Code §14-16-4-1 and §14-16-4-3.

14.5. Implementation Matrix: See **Table 14.1.**

CHAPTER IV: GOALS, POLICIES, AND IMPLEMENTATION

14.0 IMPLEMENTATION

AGENCY & ORGANIZATION ACRONYMS USED IN THE FOLLOWING TABLE:

AMAFCA	=	Albuquerque Metropolitan Flood Control Authority	GARTC	=	Greater Albuquerque Recreational Trails Committee
ABCWUA	=	Albuquerque-Bernalillo County Water Utility Authority	MRCOG	=	Mid Region Council of Governments
CNM	=	Central New Mexico Community College	NMDOT	=	New Mexico Department of Transportation
DMD	=	Department of Municipal Development (CABQ)	PNM	=	Public Service Company of New Mexico (Electric Utility)
GABAC	=	Greater Albuquerque Bicycling Advisory Committee	UNM	=	The University of New Mexico

TABLE 14.1 –IMPLEMENTATION MATRIX

ELEMENT	ID	POLICY IMPLEMENTED	PRIORITY	ACTION	LEAD AGENCY	COORDINATION REQUIRED
A. ENVIRONMENT AND OPEN SPACE						
Open Space Acquisition	A-1	13.1.1	Short-term	Prioritize open space acquisitions in Volcano Heights	City Open Space Division	Council
Transfer-of-Development Rights (TDRs)	A-2	13.1.3, 13.1.5	Medium-term	Create legal framework allowing TDRs in the City of Albuquerque or within Volcano Heights	Council/Legal	City Open Space Division
Monitoring Process for Blasting	A-3	13.1.9, 13.1.10	Medium-term	Create development process for sufficiently documenting existing conditions on a subject property and on adjacent natural resources within Escarpment Transition zone, abutting archaeological sites, and adjacent to Major Public Open Space prior to any blasting required by new development and/or infrastructure	City Open Space Division	City Development staff, Property Owners
B. ECONOMIC DEVELOPMENT						
Economic Development & Recruitment	B-1	13.2.2, 13.2.6	Medium-term	Coordinate with property owners to form a BID and/or hire a master development coordinator	City Economic Development	Council, Property Owners
	B-2	13.2.6	Medium-term	Coordinate with property owners and Double Eagle Airport to recruit businesses for Volcano Heights	City Economic Development	Property Owners, Double Eagle Airport
C. TRANSPORTATION						
Transit	C-1	13.3.2	Short-term	Identify a site for park and ride	ABQ RIDE	MRCOG, Property Owners, CNM, UNM
	C-2	13.3.4	Long-term	Identify a site for transit center	ABQ RIDE	MRCOG, Property Owners

TABLE 14.1 –IMPLEMENTATION MATRIX (Cont'd)

ELEMENT	ID	POLICY IMPLEMENTED	PRIORITY	ACTION	LEAD AGENCY	COORDINATION REQUIRED
Autos	C-3	13.3.5	Short-term	Add Primary Streets to FAABS Street Designations	MRCOG	DMD/Planning
	C-4	13.3.1	Short-term	Assess costs and funding to complete the build-out of Paseo del Norte and Unser Blvd. per the cross sections in this Plan	DMD	Planning, MRCOG, Mayor's Office, Council
	C-5	13.3.1	Medium-term	Study a grade-separated interchange when traffic and/or development conditions warrant	DMD/MRCOG	NMDOT, Planning, Bernalillo County
	C-6	13.3.9	Medium-term	Study truck access to Volcano Heights to determine sufficient routes	DMD/MRCOG	NMDOT, Planning, Bernalillo County
Bikes	C-7	13.3.14	Short-term	Coordinate multi-use trails along Unser Blvd. with 50-mile Bike Loop and decide which side of Unser Blvd. and Paseo del Norte the multi-use trail should go	DMD/Parks/GABAC/GARTC	Mayor's Office
Peds	C-8	13.3.10	Long-term	Investigate grade-separated pedestrian crossings for Paseo del Norte and Unser Boulevard	DMD	Property Owners
D. LAND USE AND URBAN DESIGN						
Coordination & Maintenance	D-1	13.4.9	Medium-term	Coordinate with property owners to form a BID to oversee implementation of the Plan and ongoing maintenance of private amenities accessible to the public.	City Economic Development	Council, Property Owners
E. INFRASTRUCTURE						
Drainage Master Plan	E-1	13.5.3	Short-term	Coordinate with property owners to create a Drainage Management Plan to identify needed infrastructure and plan for its implementation	AMAFCA	Property Owners, City Hydrology
Water/Wastewater	E-2	13.5.4, 13.5.5, 13.5.6	Medium-term	Coordinate with property owners on needed improvements to water systems and execution of necessary development agreements	ABCWUA	Property Owners
Utilities	E-3	13.2.7, 13.5.2	Medium-term	Coordinate with property owners on needed improvements to electric, gas, communications, and other dry utilities	PNM, NM Gas	Property Owners
PID/SAD/TIDDs	E-4	13.5.1	Medium-term	Coordinate with property owners to form PID/SAD/TIDDs when/as requested to fund infrastructure improvements	Council	Property Owners, State of New Mexico

[Amended November 5, 2014]

This Page Left Intentionally Blank

VOLCANO
HEIGHTS



Sector Development Plan

APPENDIX

Originally Adopted August 2013

Amended November 5, 2014

Table of Contents

APPENDIX

- Appendix A. Pre-existing Conditions
- Appendix B. Sector Planning Process
- Appendix C. 2013 Access Resolution for Paseo del Norte and Unser Boulevard and Traffic Study
- Appendix D. Private Preservation Options
- Appendix E. Fiscal Impact Analysis

Appendix A

Pre-existing Conditions

Appendix A. Pre-existing Conditions

A. Environment and Open Space

Volcano Heights lies between publicly owned lands preserving the volcanic Northwest Escarpment to the east and lands protecting the volcanoes and geologic windows farther west. (See **Exhibit A.1.**) Arroyos connect the Petroglyph National Monument with City-owned Major Public Open Space, generally running west to east from the geologic windows to the Northwest Escarpment. (See **Exhibit A.2.**)

Volcano Heights provides a unique portal into New Mexico's rich interplay of cultures. Most Albuquerque residents recognize the Petroglyph National Monument as an important asset and associate it with the five volcanic cones and the 17-mile Escarpment containing petroglyphs.

The Petroglyph National Monument was created by an act of the United States Congress in 1990 to preserve over 10,000 acres of sensitive lands, unique volcanic landscape, petroglyphs, and other culturally-significant features in perpetuity.

The Petroglyph National Monument includes more than 20,000 petroglyphs carved between 700 to 3,000 years ago. A 2002 National Park Service ethnographic study — “That Place People Talk About: The Petroglyph National Monument, Ethnographic Landscape Report,” by Anschuetz, et al. (hereinafter referred to as “Ethnographic Landscape Report”) — illuminates the ongoing religious and cultural value these sacred places hold for many Native Americans.

This rich document explores the meaning of the Northwest Mesa volcanic area for Pueblo and other Native American and Hispanic people. Because of space limitations, the present document approaches the meaning of the West

Mesa area from the Rio Grande Pueblos' perspective; for other perspectives, the reader is encouraged to read the entire Ethnographic Landscape Report.

The legal boundaries of the Petroglyph National Monument were constrained by the financial resources available at the time for land acquisition. For the Pueblos, the important areas include the entire lava bed, the volcanoes' caves and shafts, the petroglyphs, and additional features of comparable importance in meaning and use. The Ethnographic Landscape Report states, “Land-use planning in the face of development, to be successful, needs to consider how to sustain extant landscape traditions within an ongoing historical process” (Anschuetz 2002: 3.31, 9.9).

1. Petroglyphs

According to the Ethnographic Landscape Report, the petroglyphs focus Pueblo people's concentration and prayer. Not just representations of specific animals or people, the images are used to transmit thought, energy, and learning across space and time into other dimensions within a defined and bounded world.

As Celestino Gachupin of Zia Pueblo said, “The petroglyphs... belong to all of us now, not only the native people....The individual family that has a home that abuts the Monument... you are our eyes and ears now, as far as ensuring that nothing bad happens to the place.”

2. Shrines, Caves, Lava Tubes in Volcanoes, Recesses in the Escarpment Face, and Elsewhere

Various other West Mesa sites function with the petroglyphs as in interlocking system of spiritual communication. The lava tubes and caves near

Appendix A. Pre-existing Conditions

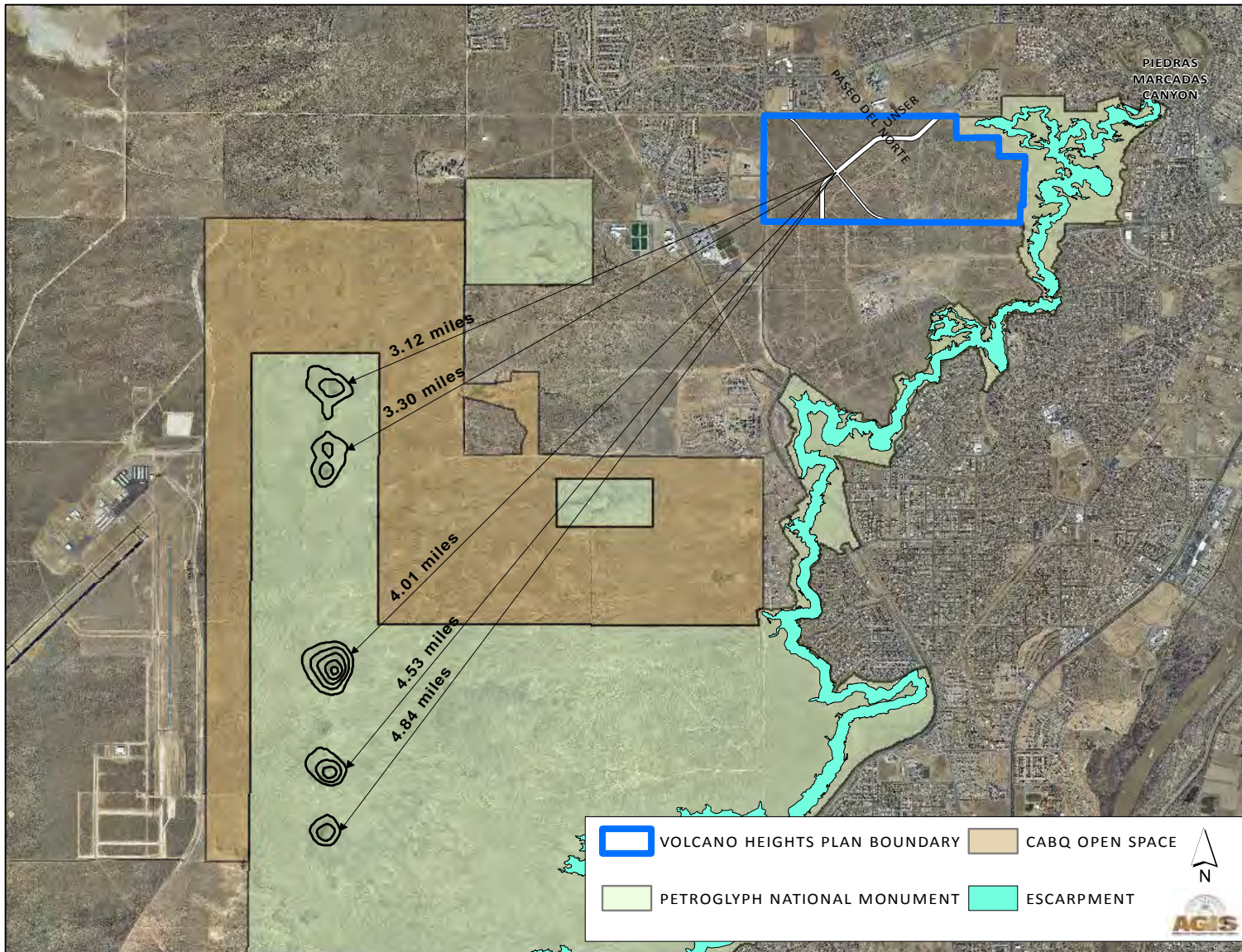

Path: Q:\AGISFILE\PROJECTS\PetraMorris\THG-Nov11-VolcanoHeights\December2012\VH_views.mxd

Exhibit A.1 – Volcano Heights, Volcanoes, and Petroglyph National Mounument

APPENDIX

Appendix A. Pre-existing Conditions

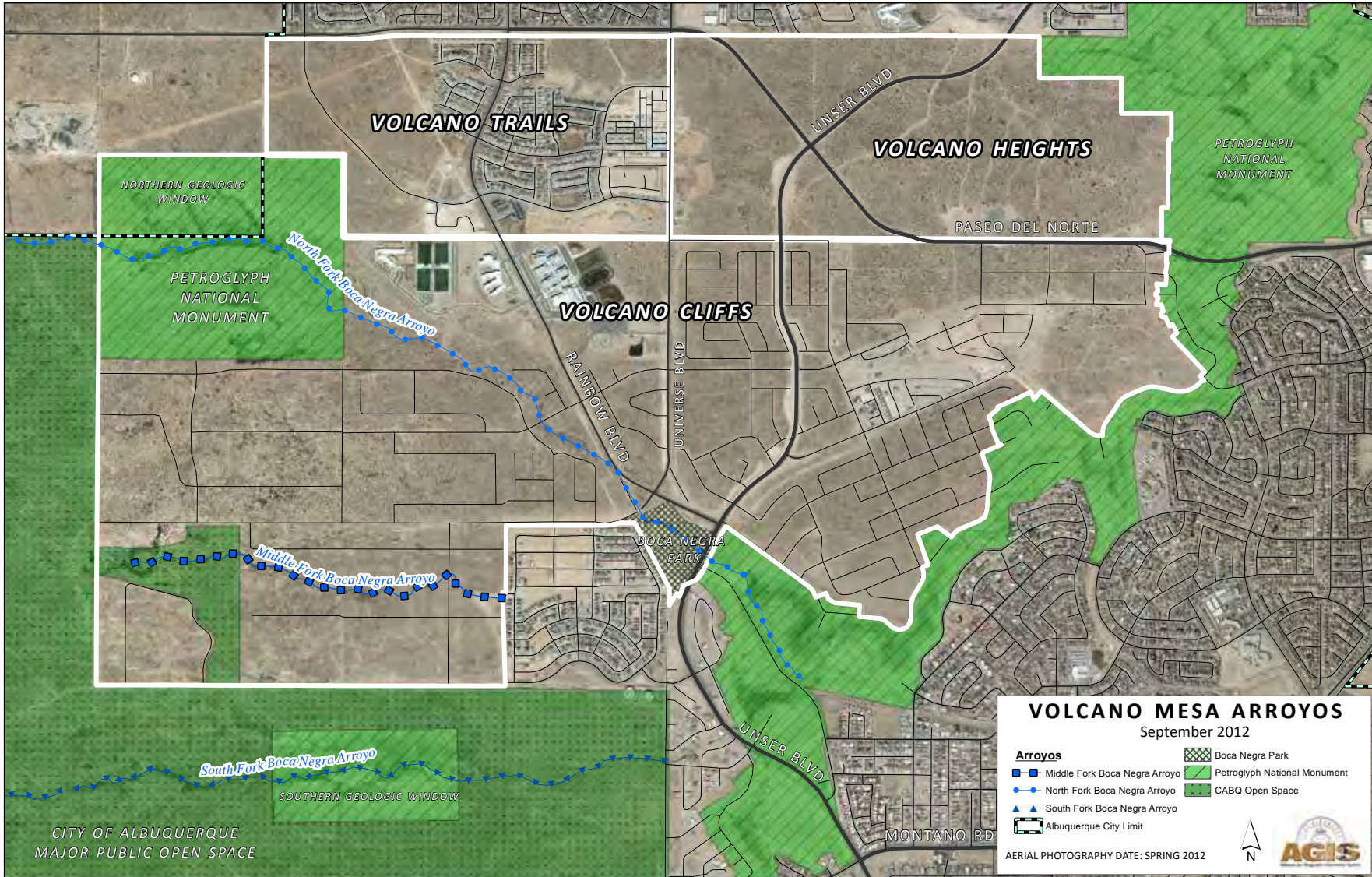

Exhibit A.2 – Arroyos in Volcano Mesa

Appendix A. Pre-existing Conditions

two northernmost Volcanoes west of the Plan area contained shell beads, pendants, turquoise, hematite, selenite, mica, colored pebbles, prayer sticks, and feathers. These are places “where the world breathes” and prayers are directed. Arrangements of stones, boulders with pecked ground facets, stone piles, prominent boulders, recesses in the Escarpment, or rock spires are similarly meaningful (Anschuetz 2002: 3.24-25).

The Pueblo World is often depicted as a bowl in the landscape with the community’s plaza at its center, extending to distant mountains, with upper and lower realms as the places of the gods, the deceased, water, breath, transformation, and more. (See **Exhibit A.3.**) The periphery of the traditional Pueblo world was defined by the Rio Grande, the West Mesa’s Volcanic cones, the Escarpment, the Sandia Mountains, and more distant mountains (Anschuetz 2002: 3.3, 3.8, 3.14).

3. Plazas

Plazas physically express the Pueblos’ center and open the villages to the landscape. Pueblo people channel blessings across the landscape through shrines and special places, and the blessings intersect with the upper and lower worlds, where they are transformed and gain increased power. As they return to the people, these strengthened blessings renew the cycle of life from the plaza center (Anschuetz 2002: 3.8-3.12).

4. The Sandia Mountains

On the edge of the bowl that forms the Pueblo World, the Sandias are the home for important shrines and the highest earth spirits, who protect the communities below and visit the West Mesa lava bed (Anschuetz 2002: 3.21-22).

5. Pathways

Trails connecting former villages along the Rio Grande with each other ran up the valley slopes and Escarpment, past the petroglyphs and shrines, to the volcanoes and mountains beyond. The trails were used for hunting, gathering, agricultural, and traditional and cultural activities. Because in Pueblo life, there is little separation of the functional from the spiritual, the paths form an interrelated flow of energy and movement along the trails that can be considered a ritual pilgrimage (Anschuetz 2010: 3.31, 3.33-34). There are concentrations of petroglyphs on Escarpment paths along the Boca Negra and Piedras Marcadas arroyos that lead to the volcanic cones.

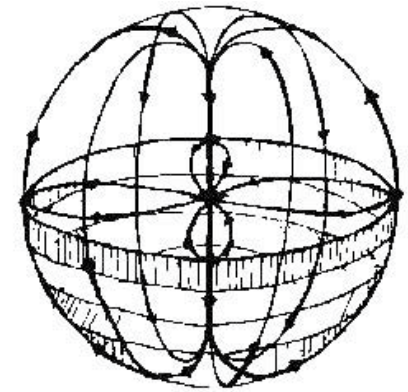

Exhibit A.3 – Diagrammatic Pueblo World View

6. Pueblo World View

Together, the elements described above constitute a world view that symbolizes a transformative healing process emanating from the West Mesa. In Pueblo terms, this is a significant place for reestablishing harmony with the environment, one another, and the spiritual dimensions of life. At the hearing to designate the Petroglyph National Monument, Pueblo members said, “We pray for peace, good health, harmony among all people, and a long and happy life” (Anschuetz 2002: 3.45-46).

7. Rock Outcroppings

The Plan area includes many outcroppings of basalt rock. Significant rock outcrops as defined in **Section 3.5** are mapped in **Exhibit 10.1** and also shown here in **Exhibit A.4**. Rock outcroppings have been used historically and culturally by Pueblo people as sacred sites. The basalt signals a place where upper and lower realms coexist and commune, and such outcroppings represent spaces of great liminal power, particularly as prayer sites.

APPENDIX

Appendix A. Pre-existing Conditions

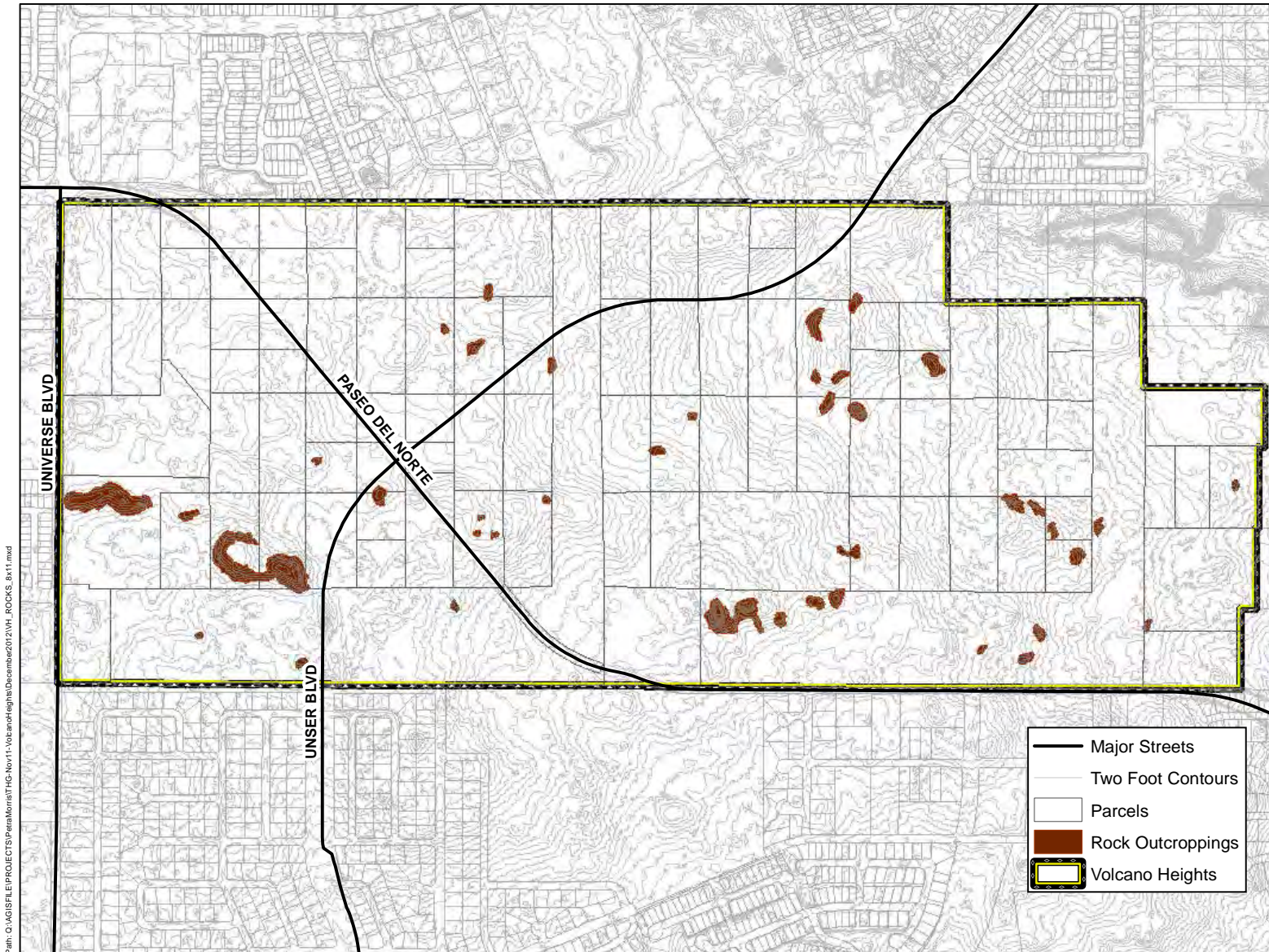

Exhibit A.4 – Significant Rock Outcroppings in Volcano Heights

Appendix A. Pre-existing Conditions

8. Soils and Geologic Conditions

Flows of basalt at varying depths and widths run through the Plan Area. These flows issued from volcanic fissures related to the subsidence of the Albuquerque basin approximately 190,000 years ago.

According to a June 1987 Albuquerque West Mesa Petroglyph Study by the National Park Service, "Soil has formed on West Mesa as the rocks have slowly weathered. The common parent materials are basalt and fine alluvial silt and sand. Sand is common in this environment and, if not part of the parent rock, is soon added by the wind. On the mesa top, soil varies in depth from 0 feet on the Escarpment rim and volcanic cones to more than 5 feet in broad areas of little slope."

According to the Northwest Mesa Escarpment Plan (NWMEP), soils in Volcano Heights are Alameda sandy loam at 0-5% slopes. Moderately deep and well drained, runoff is medium and water erosion is slight.

9. Drainage Channels

No named arroyos managed by the Albuquerque Metropolitan Arroyo Flood Control Authority (AMAFCA) lie within the Plan area. (See **Exhibit A.2.**) Water does flow to the northeast in the Plan area near Piedras Marcadas Canyon.

Drainage channels have played an important cultural role for prehistoric communities, connecting ceremonial sites on the volcanic mesa through the Escarpment to former Pueblo villages along the Rio Grande. Arroyos and drainage channels maintain rich habitat for plant and animal species along wildlife corridors that ecologically link the largest expanses of open space to each other.

Existing Open Space adjacent to the Plan does not have a fully developed formal trail system to link open space into a consolidated network. Drainage channels can be important corridors for walking and biking trails that could link natural open areas.

APPENDIX

Appendix A. Pre-existing Conditions

TABLE A.1 – POPULATION COMPARISON, 2000-2010

	2000 Population	2010 Population	Population Growth	Percent Change
Volcano Heights Study Area	50,761	91,217	40,456	80%
City of Albuquerque	448,607	545,852	97,245	22%
City of Rio Rancho	51,765	87,521	35,756	69%

Sources: 2010 Census SF 1 Data, MRCOG

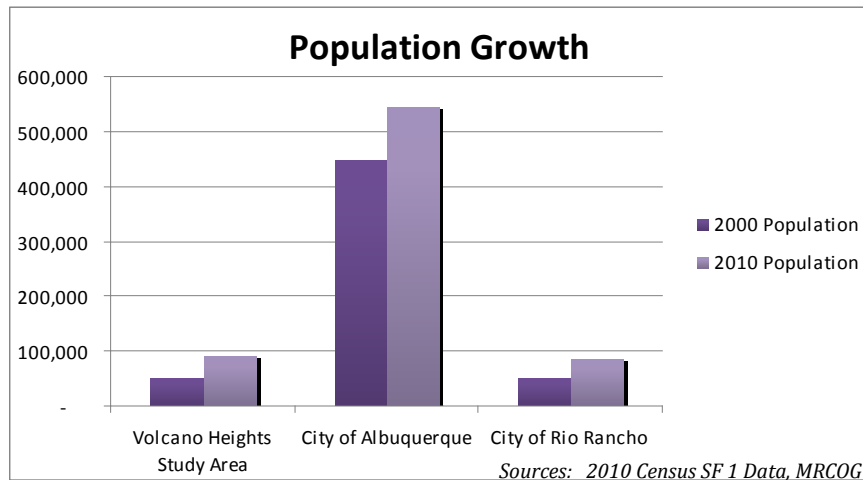

Exhibit A.5 – Comparative Population Growth, 2000-2010

TABLE A.2 – HOUSEHOLD SIZE, 2010

Geography	Average Household Size
Volcano Heights Study Area	2.7
City of Albuquerque	2.4
City of Rio Rancho	2.7

Sources: 2010 Census SF 1 Data, MRCOG

B. Demographics

1. Methodology

Because the land within Volcano Heights is undeveloped, City staff worked with the Mid-Region Council of Governments (MRCOG) to create a study area for Volcano Heights that could be compared to the larger geographies of the City of Albuquerque and the City of Rio Rancho.

MRCOG generated a 10-minute commute shed from the intersection of Paseo del Norte and Unser Boulevard using its Transportation Accessibility Model (TRAM) and current posted speeds. The 10-minute commute shed provides a study area of adequate size and coincides well with 2010 Census Tracts.

Nineteen (19) census tracts are included in the study area, shown in **Exhibit A.6**. Census tract 9406 west of Volcano Heights extends to Cibola County and includes tribal lands and other areas not comparable to the other census tracts. In order to avoid skewing figures for the Volcano Heights study area, MRCOG staff only incorporated individual census blocks out of tract 9406, including 4,603 residents in West Ventana Ranch.

2. Population

The Volcano Heights study area has a population comparable to the City of Rio Rancho, both just over 50,000 residents. (See **Exhibit A.5**.) The population within the City limits of Albuquerque is just under 450,000 people. Both Rio Rancho and the Volcano Heights study area show a high growth rate between 2000 and 2010, with 80% growth in Volcano Heights. The City of Albuquerque is growing more slowly but still shows significant growth in 10 years at almost 25%. (See **Table A.1**.)

Appendix A. Pre-existing Conditions

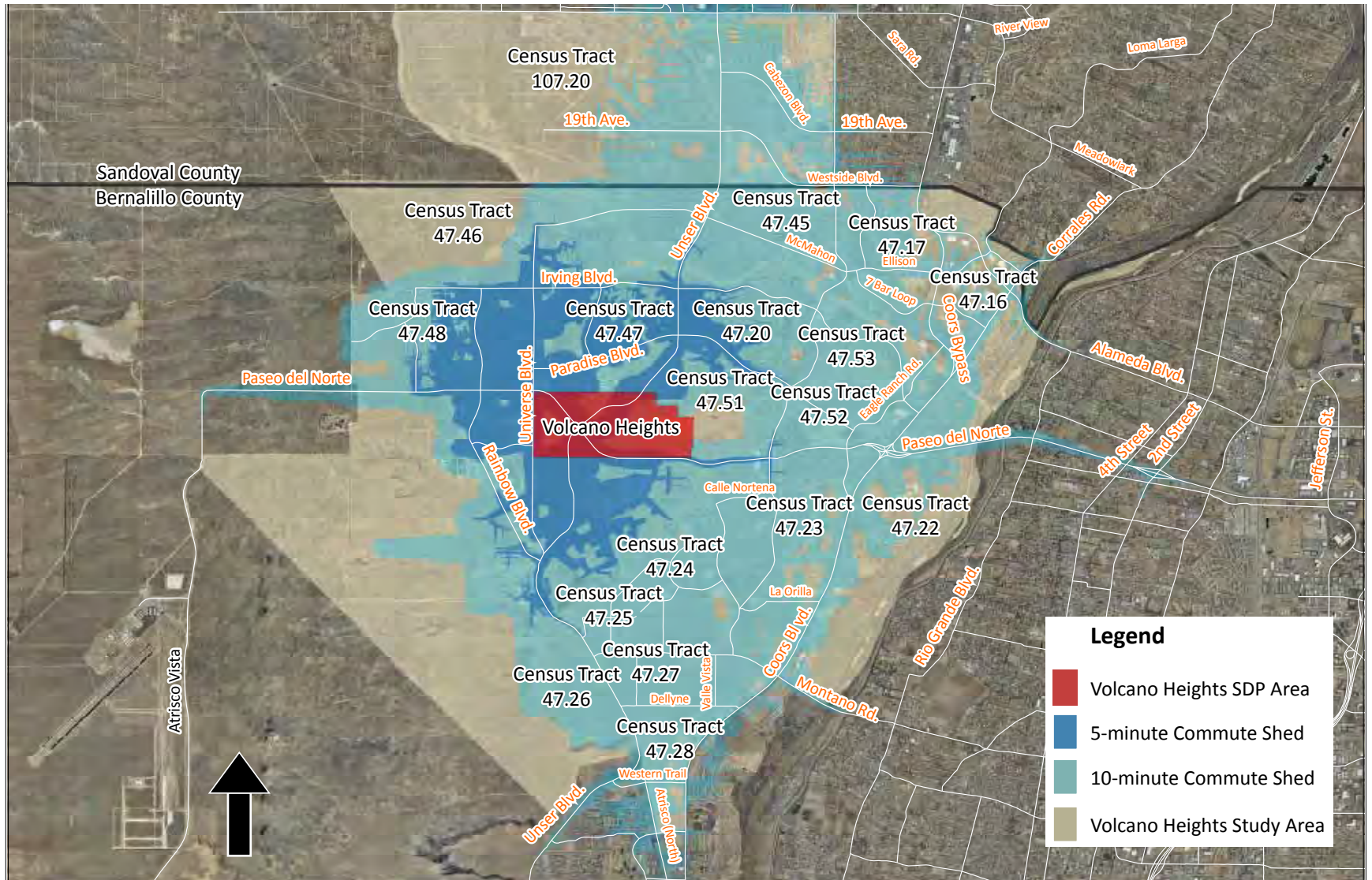

Source: AGIS and MRCOG

Exhibit A.6 – Volcano Heights Study Area

APPENDIX

Appendix A. Pre-existing Conditions

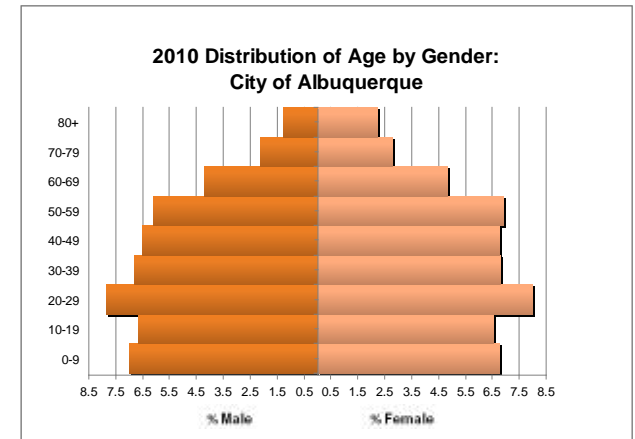
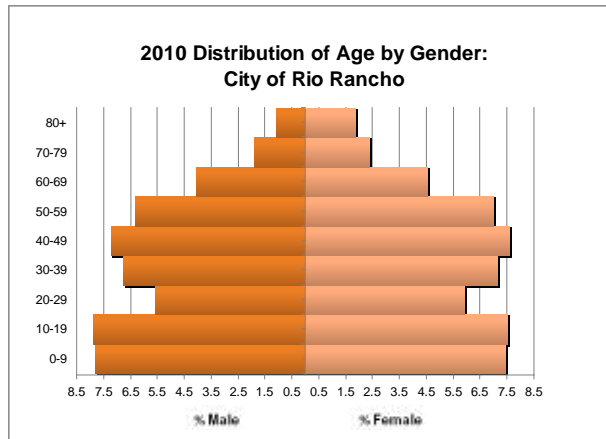
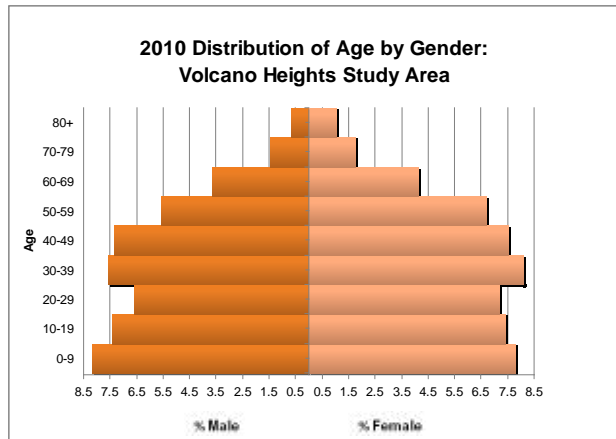

Exhibits A.7-9 – Population Pyramids, 2010: Volcano Heights Study Area, City of Rio Rancho, and City of Albuquerque

Sources: 2010 Census SF 1 Data, MRCOG

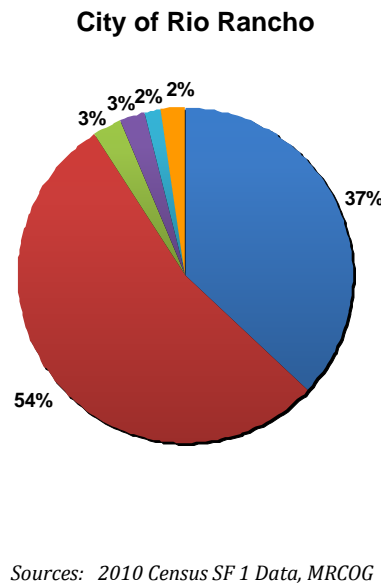
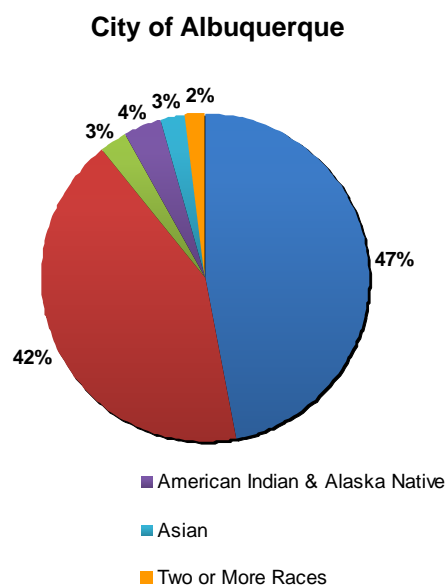
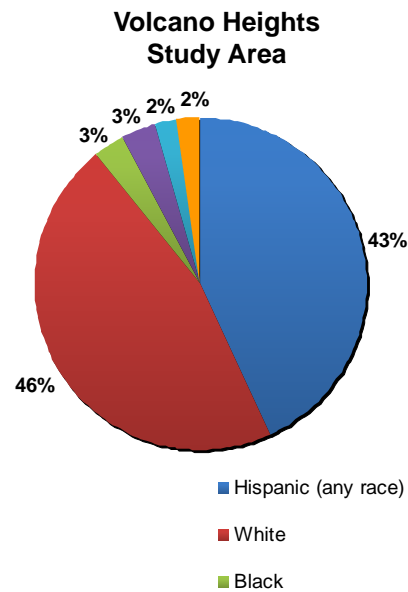

Sources: 2010 Census SF 1 Data, MRCOG

Exhibits A.10-12 – Race and Ethnicity, 2010: Volcano Heights Study Area, City of Albuquerque, and City of Rio Rancho

Population pyramids indicate growth conditions for Volcano Heights and Rio Rancho. (See **Exhibits A.7-9.**) There is a high percentage of the population in the child-bearing years, as well as a high percentage of young children that can lead to population growth over time. The dip in population for those 20-29, particularly in Rio Rancho, may indicate that people are leaving for college or jobs elsewhere.

In comparison, the population pyramid for the City of Albuquerque shows conditions for much slower rate of growth over time. The bump of population for those 20-29 may indicate that people are moving to Albuquerque for college or job opportunities.

In 2010, the Volcano Heights study area was 46% White and 43% Hispanic. (See **Exhibits A.10-12.**) Albuquerque was 47% Hispanic and 42% White. Rio Rancho was 54% White and only 37% Hispanic.

Appendix A. Pre-existing Conditions

TABLE A.3 – HOUSING UNITS COMPARISON, 2010

Area	Total Housing Units	Occupied Housing Units	Percent Occupied	Vacant Housing Units	Percent Vacant	Owner-Occupied Housing Units	Percent Owner-Occupied	Renter-Occupied Housing Units	Percent Renter-Occupied
Volcano Heights Study Area	35,726	33,896	95%	1,830	5%	24,596	73%	9,300	27%
City of Albuquerque	239,166	224,330	94%	14,836	6%	135,267	60%	89,063	40%
City of Rio Rancho	33,964	31,892	94%	2,072	6%	25,149	79%	6,743	21%

Sources: 2010 Census SF 1 Data, MRCOG

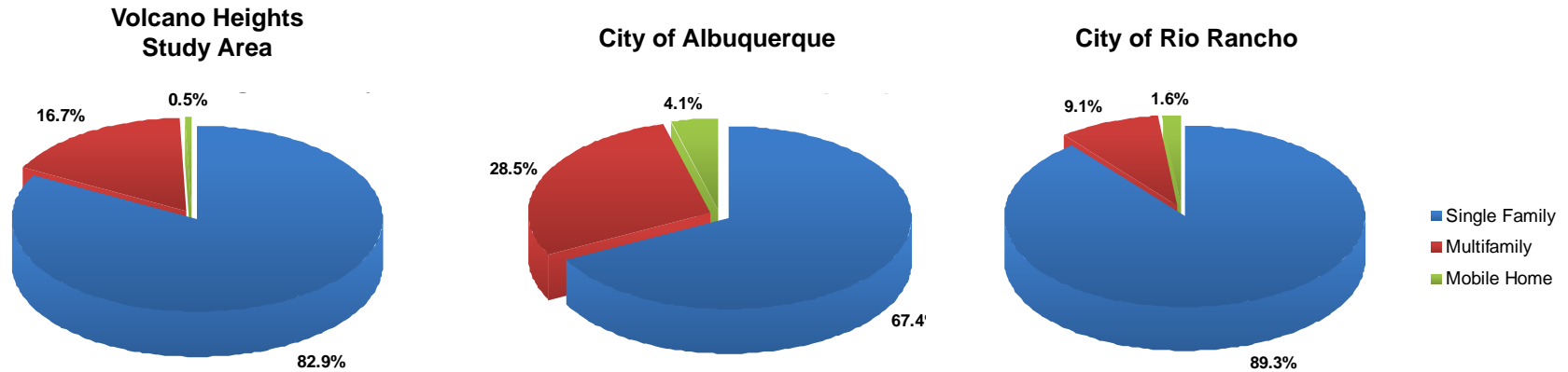

Sources: U.S. Census Bureau, American Community Survey 2006-2010, MRCOG

Exhibits A.13-15 – Housing Types, 2010: Volcano Heights Study Area, City of Albuquerque, and City of Rio Rancho

3. Housing

The three areas show a predominance of single-family housing. (See Table A.3 and Exhibits A.13-15.) The City of Albuquerque has the highest percentages of multifamily and mobile homes. The Volcano Heights study area shows a higher portion of multifamily than Rio Rancho, while Rio Rancho shows a slightly higher portion of mobile homes than the Volcano Heights study area.

Both the Volcano Heights study area and Rio Rancho include approximately 35,000 housing units, while the City of Albuquerque includes almost 240,000. In all three cases, almost all units are occupied. Vacancy rates for all three are approximately 5%. The City of Rio Rancho has the highest proportion of owner-occupied units (79%), followed by the Volcano Heights study area (73%). The City of Albuquerque has the highest proportion of renter-occupied units (40%).

APPENDIX

Appendix A. Pre-existing Conditions

TABLE A.4 - HOUSING CONSTRUCTION YEAR, 2010

Year Structure Built	Volcano Heights Study Area		City of Albuquerque		City of Rio Rancho	
	Units	Percent	Units	Percent	Units	Percent
2005 or Later	3,715	12%	11,224	5%	5,139	16%
2000 - 2004	7,883	25%	27,532	12%	6,424	20%
1990 - 1999	11,519	36%	36,677	16%	7,856	25%
1980 - 1989	5,034	16%	35,359	15%	7,681	24%
1970 - 1979	2,895	9%	48,148	20%	4,021	13%
1960 - 1969	807	3%	25,928	11%	731	2%
1950 - 1959	133	0%	31,695	13%	92	0%
1940 - 1949	54	0%	10,786	5%	85	0%
1939 or Earlier	31	0%	7,542	3%	34	0%
Total Housing Units	32,071	100%	234,891	100%	32,063	100%

Sources: U.S. Census Bureau, American Community Survey 2006-2010, MRCOG

TABLE A.5 - HOUSEHOLD INCOME, 2010

Income Category	Volcano Heights Study Area		City of Albuquerque		City of Rio Rancho	
	Estimate	Percent	Estimate	Percent	Estimate	Percent
Less than \$10,000	891	3%	18,456	8%	1,177	4%
\$10,000 to \$14,999	645	2%	12,159	6%	1,005	3%
\$15,000 to \$24,999	1,872	6%	24,819	11%	2,632	9%
\$25,000 to \$34,999	2,563	8%	26,330	12%	2,477	8%
\$35,000 to \$49,999	4,195	14%	32,942	15%	5,007	17%
\$50,000 to \$74,999	7,318	24%	40,563	19%	6,694	23%
\$75,000 to \$99,999	5,265	17%	25,078	12%	4,669	16%
\$100,000 to \$149,999	5,021	16%	23,460	11%	4,356	15%
\$150,000 to \$199,999	1,894	6%	8,217	4%	975	3%
\$200,000 or more	790	3%	5,232	2%	734	2%
Total households	30,454	100%	217,256	100%	29,726	100%

Sources: U.S. Census Bureau, American Community Survey 2006-2010

Both Rio Rancho and the Volcano Heights study area show a relatively high percentage (12 and 16% respectively) of structures built since 2005. (See **Table A.4.**) In both areas, the largest percentage of structures were built in the 1990s. In the City of Albuquerque, the highest percentage (20%) of housing units were built in the 1970s.

4. Income and Education

There are just over 30,000 households in Volcano Heights, similar to the City of Rio Rancho. (See **Table A.5** and **Exhibit A.16.**) Average household size is 2.4 in both Volcano heights and Rio Rancho and slightly higher in the City of Albuquerque at 2.7. (See **Table A.2.**)

In all three areas, the highest percentage have incomes between the range of \$50,000-70,000. The City of Albuquerque has a higher portion of households at the lower range of incomes, with 25% earning less than \$25,000 per year. Volcano Heights study area has the lowest percentage at the lower income range, with only 11% earning less than \$25,000, and the highest percentage of the highest income range, with 25% earning more than \$100,000 per year.

The vast majority of the population over age 25 in all three areas has a high school diploma or equivalent, with only 5.2% in Volcano Heights without a diploma, compared to 6.6% in Rio Rancho and 13% in Albuquerque. (See **Exhibit A.17.**) Almost half of those over age 25 in Volcano Heights study area have an associates degree or higher (46%), compared to 38% in Albuquerque and 38% in Rio Rancho.

Appendix A. Pre-existing Conditions

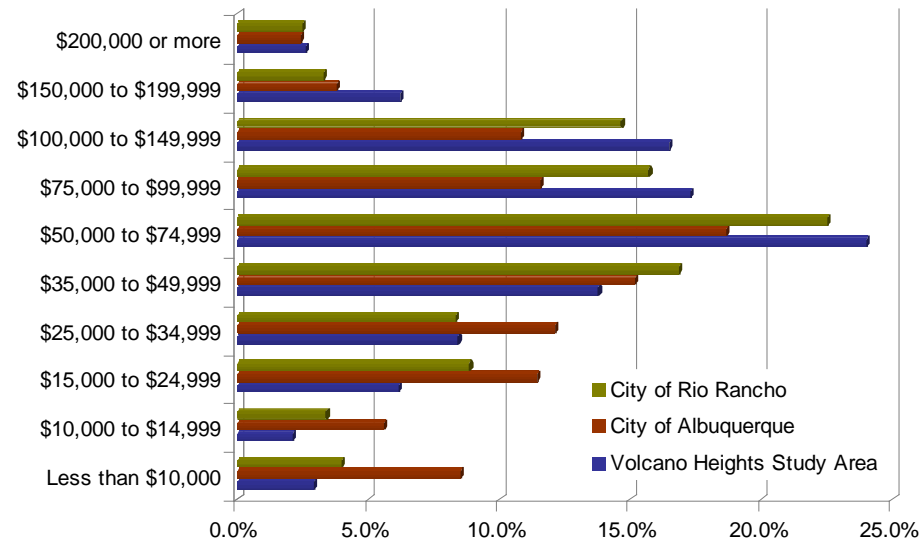

Sources: U.S. Census Bureau, American Community Survey 2006-2010, MRCOG

Exhibit A.16 – Household Income, 2010

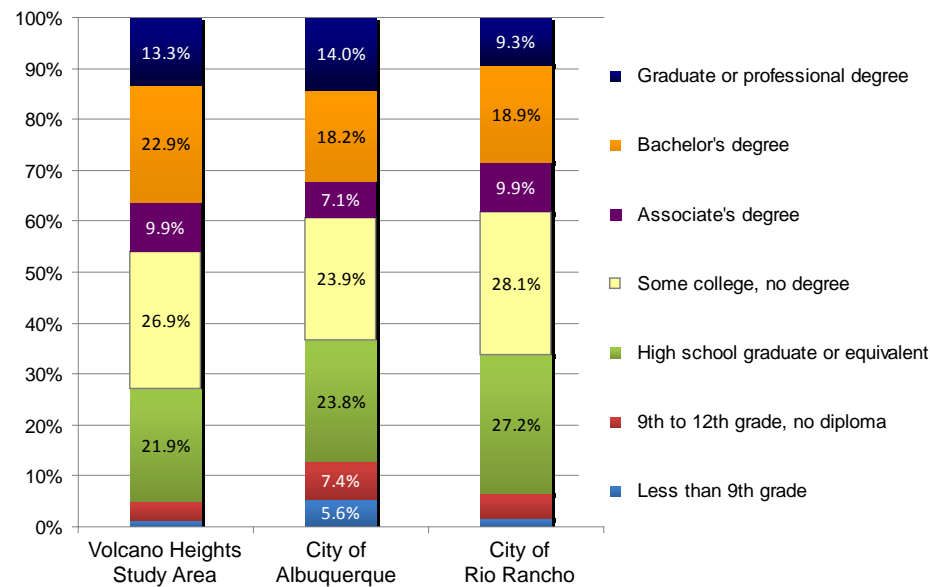

Sources: U.S. Census Bureau, American Community Survey 2006-2010, MRCOG

Exhibit A.17 – Education Level of Population Age 25+, 2010

Appendix A. Pre-existing Conditions

C. Economic Development

1. Major Activity Centers

The land within Volcano Heights is undeveloped, but the area has been recommended to be designated as a Major Activity Center by the Volcano Mesa amendment to the Rank II West Side Strategic Plan. A Major Activity Center would provide an opportunity to address the imbalance of jobs east of the river and predominantly housing on west of the river by serving the region with employment, commercial, service, and retail opportunities. The Comprehensive Plan's Centers and Corridor Plan would need to be updated to finalize the designation. It is unknown at this time when that final step will be taken.

Major Activity Centers (MACs) are meant to focus area employment and commercial and retail opportunities in particular locations well-served by existing transportation systems. Per the Comprehensive Plan, Major Activity Centers must be located on large tracts of undeveloped land (300 acres or more) and must be located at the intersection of two major roadways. Opportunities for designation of a Major Activity Center on the West Side other than Volcano Heights are limited due to a lack of undeveloped land near two critical roadways. The Volcano Heights area provides a critical opportunity for the West Side to locate a mix of employment, commercial, service and residential uses to meet the needs of the wider area and decrease cross-river traffic.

The Albuquerque-Bernalillo County Comprehensive Plan designates two areas on the West Side of Albuquerque as Major Activity Centers (MAC): the Cottonwood Center and the Atrisco Business Park. (See **Exhibit A.18.**) These areas have developed in a low-density, auto-oriented, and single-use pattern.

Four areas on the West Side are designated as Proposed Major Activity Centers; however, these are all west of Paseo del Volcan.

The east side of Albuquerque contains ten designated Major Activity Centers. According to MRCOG, in 2008, there were 152,300 jobs provided on the east side of Albuquerque in the top seven activity centers on the east side, including Downtown, Uptown, UNM/CNM/Hospitals, Jefferson/I-25, Midtown, Sunport, and Kirtland Air Force Base. This is in stark contrast to the 14,400 jobs available in 2008 on the west side in the Intel/Cottonwood and Atrisco Business Park centers.

This suggests that the majority of people who live on the west side find their employment on the east side of the river, and, as an auto-oriented city, this has led to significant traffic problems today, which are predicted to continue and worsen over time. According to MRCOG, based on present-day land-use and zoning policies, the current trend of employment growth concentrated on the east side of the Rio Grande will continue and will far outpace employment growth on Albuquerque's West Side. The only way to reverse this trend is to provide significant and attractive opportunities for employers to locate on the West Side.

A comparison of several comparable MACs is shown in **Table A.6.** Commuting patterns are shown for Uptown MAC, Cottonwood MAC, and Journal Center MAC in **Exhibits A.25-27.**

Appendix A. Pre-existing Conditions

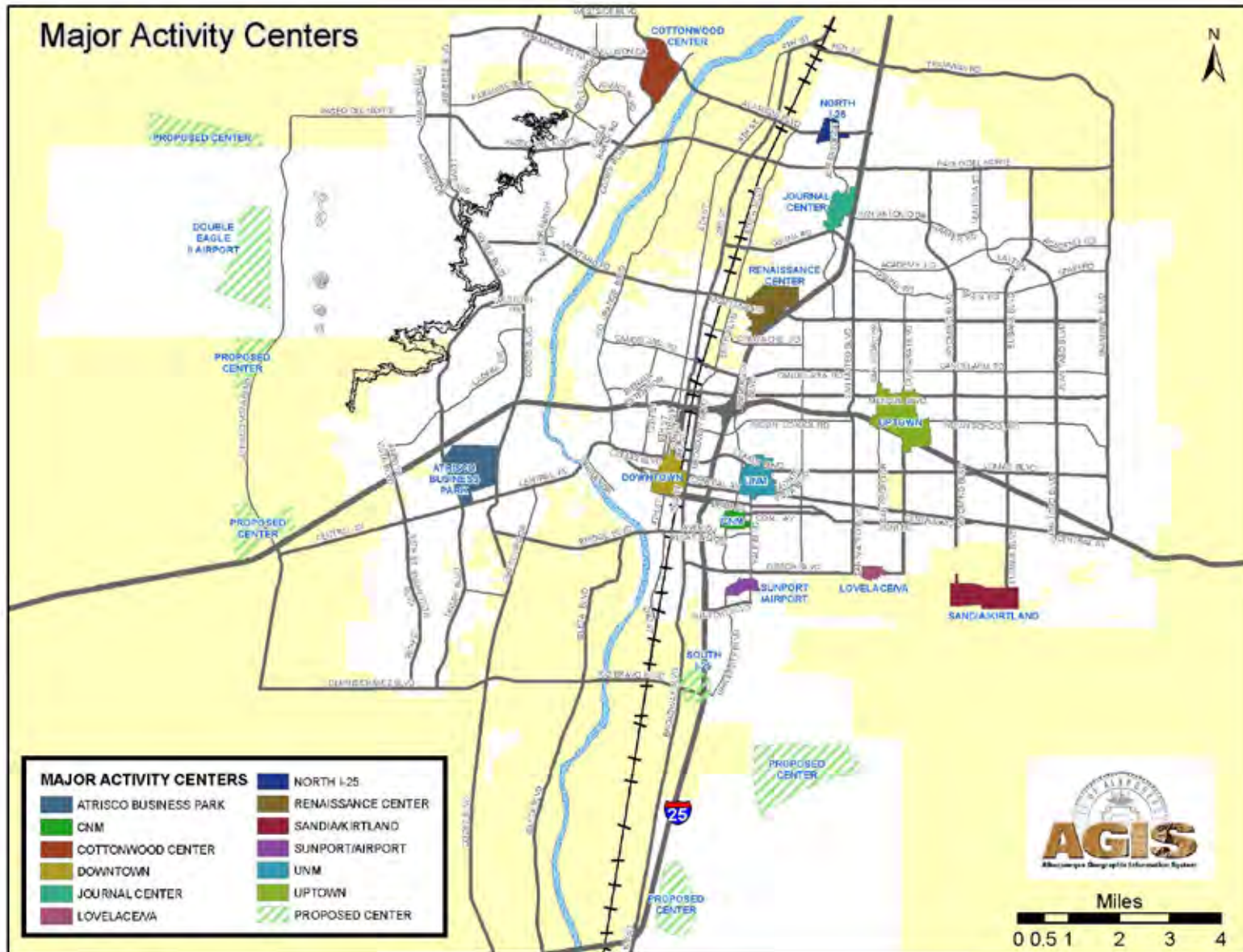

Exhibit A.18 – Major Activity Centers in Albuquerque, 2012

APPENDIX

Appendix A. Pre-existing Conditions

TABLE A.6 – MAJOR ACTIVITY CENTER COMPARISON

	Uptown	Atrisco	Renaissance Center	Cottonwood Center	UNM	Downtown	Journal Center	CNM	North I-25	Sunport	Lovlace VA
OVERVIEW											
Acres	593	547	411	366	315	282	201	128	122	96	73
Driving distance to nearest interstate	0.0 miles	0.4 miles	0.0 miles	4.1 miles	0.6 miles	0.4 miles	0.0 miles	0.6 miles	0.3 miles	0.6 miles	2.8 miles
EMPLOYMENT											
Estimated jobs (2008)	28,703	2,020	4,858	3,657	10,194	16,342	3,166	407	1,415	136	805
Commuting workers	28,567	1,990	4,858	3,657	10,174	16,251	3,166	406	1,415	136	803
Jobs/acre	48	4	12	10	32	58	16	3	12	1	11
Office sq. ft. (2011)	1.82 million	N/A	320,000	~0	900,000	2.74 million	2.80 million	N/A	N/A	1.25 million	N/A
Retail sq. ft. (2010)	1.95 million	~0	630,000	4.07 million	1.0 million	550,000	~0	N/A	N/A	N/A	N/A
Total sq. ft.	3.77 million	N/A	950,000	~4.07 million	1.9 million	3.29 million	~2.80 million	N/A	N/A	N/A	N/A
COMMUTE LENGTH (2009)											
Less than 10 miles	76%	56%	68%	57%	78%	77%	70%	76%	68%	65%	72%
10 to 24 miles	15%	30%	11%	16%	13%	13%	11%	15%	12%	22%	20%
25 to 50 miles	2%	3%	6%	10%	3%	2%	6%	2%	7%	4%	2%
Over 50 miles	7%	12%	15%	17%	7%	7%	13%	7%	14%	9%	6%
TRAFFIC COUNTS (2010)											
High	30,600	34,250	35,850	45,400	26,900	23,700	62,250	21,250	30,750	11,650	20,700
Low	11,600	19,650	8,650	18,800	9,500	5,150	21,733	10,850	7,100	9,800	13,000
High Street	Louisiana	Coors	Montaño	Coors Bypass	Central	Lomas	Paseo del Norte	Avenida Cesar Chavez	Alameda	Yale	Gibson
Low Street	Indian School	Central	Renaissance	Coors	Girard	Third	Jefferson	Coal	Jefferson	Randolph	San Mateo

Sources: AGIS; MRCOG; Grubb & Ellis Market Trends report, 1st quarter 2011 (Office); Grubb & Ellis Market Trends report, 4th quarter 2010 (Retail); MTP 2035 Roadway Functional Classification Map

Appendix A. Pre-existing Conditions

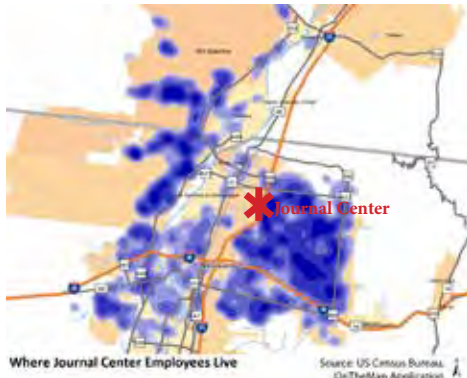
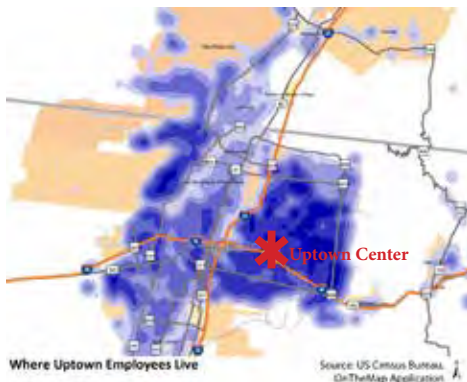

Exhibit s A.19-21 – Journal Center: Commuting Pattern, Traffic Counts, and Photo 2010



Exhibit s A.22-24 – Cottonwood Center: Commuting Pattern, Traffic Counts, and Photo 2010



Exhibits A.25-27 – Uptown Center: Commuting Pattern, Traffic Counts, and Photo 2010

APPENDIX

Appendix A. Pre-existing Conditions

TABLE A.7 – EMPLOYMENT IN VOLCANO HEIGHTS STUDY AREA, 2008

Industry	Employment Estimate	Percent
Retail Trade	6,022	32%
Eating and Drinking	3,364	18%
Educational Services	2,227	12%
Health Care & Social Assistance	1,586	9%
Other Services	1,364	7%
Professional, Scientific, Technical	676	4%
Construction	612	3%
Finance & Insurance	539	3%
Real Estate, Rental & Leasing	459	2%
Admin, Support, Waste Management, Remediation	297	2%
Government	283	2%
Arts, Entertainment & Recreation	259	1%
Information	197	1%
Manufacturing	195	1%
Wholesale Trade	185	1%
Unknown and Other	141	1%
Transportation and Warehousing	76	0%
Accommodation & Food Services <i>(except eating and drinking)</i>	24	0%
Agriculture, Forestry, Fishing	11	0%
Utilities	8	0%
Management of Companies	6	0%
Mining	2	0%
Total Employment	18,533	100%

Sources: Infogroup Dataset, National Industrial Classification, and MRCOG

2. Jobs and Employment

There are approximately 18,500 jobs within the Volcano Heights study area, primarily retail, including eating and drinking. (See **Table A.7.**) Educational sector and health sector jobs are the next highest percentage of jobs, with 12% and 9% respectively. A map of job sites in the study area, including employers with over 100 employees, is shown in **Exhibit A.28.** Professional jobs represent only 4% of jobs in the study area, and manufacturing represents only 2% of jobs. Both would be potential targets for new employers within Volcano Heights in the future.

Appendix A. Pre-existing Conditions

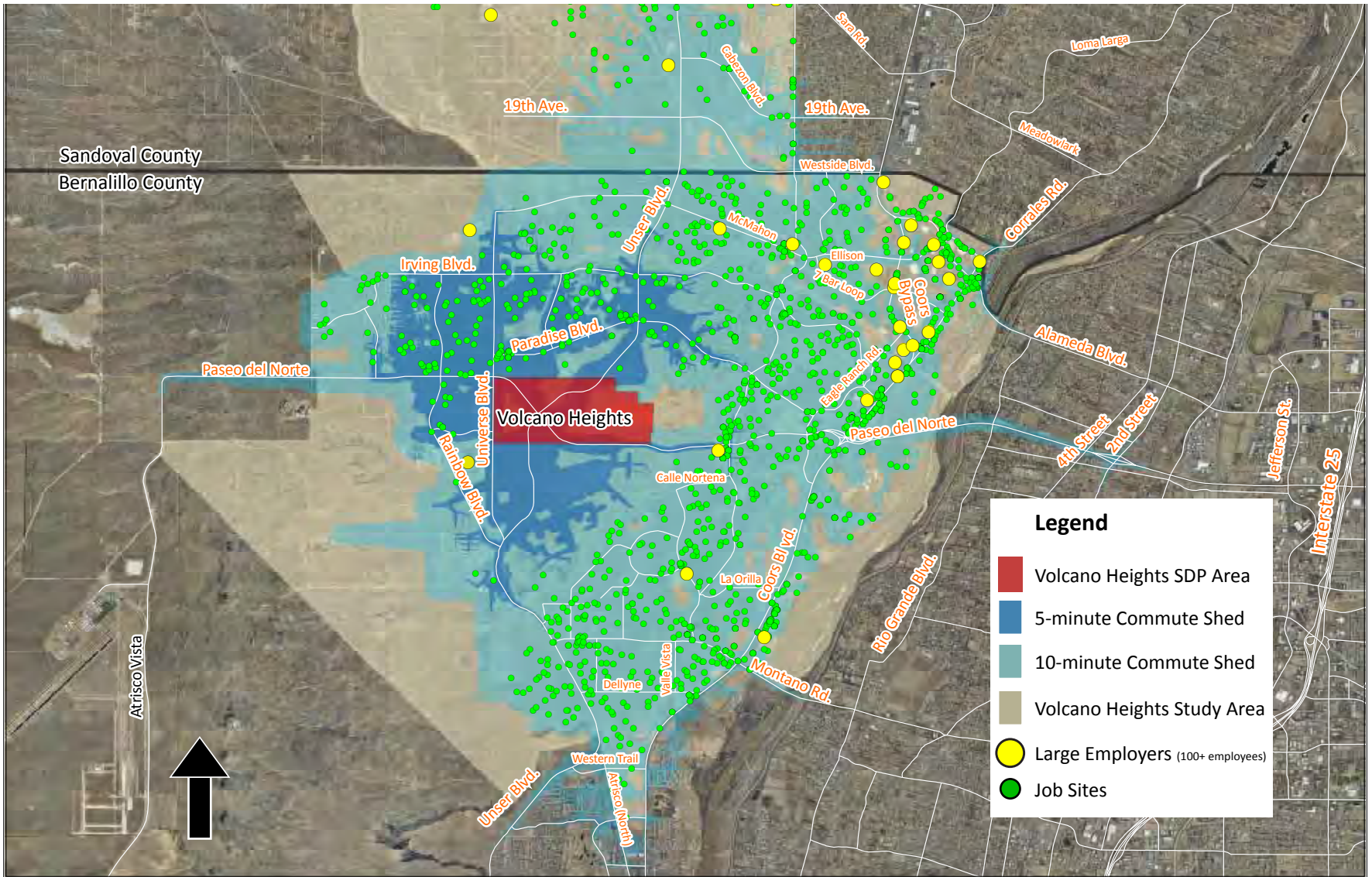

Source: AGIS and MRCOG

Exhibit A.28 – Employment Locations, 2010: Volcano Heights Study Area

Appendix A. Pre-existing Conditions

D. Transportation

In its 2035 Metropolitan Transportation Plan, MRCOG forecast that the four county Mid-Region Metropolitan Planning Organization (MRMPO) area (Bernalillo, Sandoval, Valencia and Tarrant counties) would grow by 668,000 people, 310,000 new homes, and 210,000 new jobs. Development West of the Rio Grande is expected to capture almost half the new growth, but only 20% of new jobs. If the area continues to develop with its current land-use pattern of generally low density, auto-oriented growth on the fringe of the urbanized area, the growing gap between homes and jobs will increase congestion on the region's transportation corridors and, particularly, the region's river crossings.

1. Regional Roads

MRCOG is the designated Metropolitan Planning Organization (MPO) for the Albuquerque Metropolitan Planning Area (AMPA). MRCOG convenes meetings for decision-makers from jurisdictions within the AMPA to come together to plan for transportation and other decisions affecting the region.

Relevant Documents:

- Future Albuquerque Area Bikeways and Streets (FAABS) [To be updated and renamed Long Range Transportation System]
- Metropolitan Roadway Access Policies for the Albuquerque Metropolitan Planning Area (AMPA) [2010 Appendix to FAABS]
- Long-range Roadway System Map (2004)
- 2035 Metropolitan Transportation Plan (5-year plan)

Relevant Agencies, Boards, & Committees:

- Mid-region Council of Governments (MRCOG)
- New Mexico Department of Transportation (NMDOT)
- City of Albuquerque Department of Municipal Development (DMD)
- Metropolitan Transportation Board (MTB)
- Transportation Coordinating Committee (TCC)

The Metropolitan Transportation Board (MTB) is made up of elected officials from the jurisdictions within the AMPA and sets policy for transportation issues in the urban area. The MTB coordinates local government transportation planning and project development, identifies federal funding for transportation projects, including roadway widenings and extensions, sets policy for roadway access, identifies corridors and alignments for new roadways, identifies bicycle facilities and federal funding for them, and makes decisions about long-range issues such as Bus Rapid Transit proposals.

Limited Access Roadways are identified and the Access Control Policies are stated in the Future Albuquerque Area Bikeways and Streets (FAABS) in Appendix D – III, Access Limitations. The components of the FAABS, including the Limited Access Roadways and the Access Control Policies, are integrated into the 2035 Metropolitan Transportation Plan (MTP) and all future MTP updates. All of these documents are being revised as of 2013.

Appendix A. Pre-existing Conditions

a. Road Classification

As of 2012, the functional classifications for Paseo del Norte and Unser Boulevard are Urban Principal Arterials on the Long Range Roadway System Map. MRCOG will be adding Primary Streets as shown in **Exhibit 10.1 on page 167** to the Long Range Roadway System Map during its next update.

Paseo del Norte and Unser Boulevard are identified in FAABS as limited-access roadways. The TCC approved additional access points in Volcano Mesa to support development in Volcano Cliffs and Volcano Heights. [See TCC Resolution 2013-03 in **Appendix C.**]

These and existing access points are shown in **Exhibit 10.3 on page 171**. Access to the Plan areas is to be provided via Primary Streets connected to these access points, and access to individual developments is to be provided via Secondary Streets.

b. Ownership and Construction

In this area, the City owns, controls, and is responsible for the planning and maintenance of both Paseo del Norte and Unser Boulevard. Paseo del Norte is a state facility east of Eagle Ranch Road. A 1989 working agreement between the City and State states that once Paseo del Norte is constructed to four (4) lanes, it will revert to a State facility to Universe Boulevard.

The City's Department of Municipal Development (DMD) developed plans in 2007 for the extension of Paseo del Norte, the cross sections for which show the two-lane construction as of 2011 and the future construction configurations of six (6) lanes with separate or shared bus rapid transit lanes. Future construction will be the responsibility of private developers as abutting land is developed.

As of 2013, the City has constructed Unser to 2 lanes with 36-foot median between Boca Negra Dam and Paradise Boulevard. Small portions north of Volcano Heights were constructed privately in conjunction with abutting development. The road widens and median narrows to provide turn lanes near major intersections. The city-owned 156-foot right-of-way from Boca Negra Dam to Paseo del Norte will allow the expansion of Unser to four (4) lanes in the future.

Assessments paid by Volcano Cliffs property owners for Special Assessment District (SAD) 228 will pay for the construction of the full cross section of the first third (1/3) of Unser north of Boca Negra Dam. A new SAD (229) is proposed for the area north of SAD 228, where Unser would straddle the boundary between Volcano Cliffs and Volcano Heights, to pay for the build out of Unser to Paseo del Norte.

The City completed construction in 2011 on roadway segments and intersections connecting Unser to Rainbow and Universe Boulevard on the southern edge of the Volcano Cliffs SDP and recently constructed a temporary road connecting Unser north of Paseo del Norte to the northern boundary of Heights. A segment of Unser north of the Plan area was constructed as Sundance Estates developed, and a new segment of Unser north of will be constructed as a new subdivision, Boulders, develops.

APPENDIX

Appendix A. Pre-existing Conditions

c. Right-of-Way (ROW)

As of 2011, right-of-way (ROW) on Paseo del Norte varies between 50-200 feet. Through the Escarpment, ROW is around 200 feet and quickly narrows to a temporary cross section at the top of the Escarpment to the existing Avenida de Jaimito, where ROW is only 50 feet. ROW is 50 feet for about 3,000 feet west along the Town of Alameda Grant line. Paseo del Norte then heads north and west within a 70-foot ROW (to be widened to 156 feet as abutting property owners dedicate land and construct the road to 4 lanes) all the way to Universe. From Universe Boulevard to Rainbow Boulevard, the City owns 156 feet of ROW.

The City owns 156 feet of ROW for Unser Boulevard between the Escarpment to Paseo del Norte. As of 2011, the City has obtained right-of-entry and is in the process of acquiring ownership of the center 78 feet of the ultimate 156-foot ROW north of Paseo del Norte to Paradise Boulevard. The remaining 78 feet of ROW will require dedication as land on either side of the road develops (i.e. 39 feet per side). Some blading and permanent fill has taken place as easements allow.

d. Intelligent Transportation Systems (ITS)

Intelligent Transportation Systems (ITS) involves strategic placement of advanced sensors and dynamic message boards located on the roadside but operated remotely from a management center, combined with advanced communications among operators of the transportation system to monitor and manage congestion on the road network. ITS can help maximize the efficiency of roadways to meet the demands placed upon them by a growing population. Advanced technology allows ITS staff to monitor travel conditions in real time and alert drivers of travel congestion and/or hazards “downstream” so that they can avoid delays and unsafe conditions. Staff can also adjust signal timing to optimize traffic flow.

ITS in the AMPA is coordinated through the MRCOG’s ITS Subcommittee, comprised of federal, state, and local stakeholders. The ITS Subcommittee makes recommendations to the TCC to ensure that all ITS deployment is conducted in a coordinated manner and meets the federal requirement for consistency with the AMPA Regional ITS Architecture.

Appendix A. Pre-existing Conditions

Many corridors involve multiple jurisdictions, making it essential to fully coordinate the response to travel conditions and hazards. MRCOG has prioritized the planning and implementation of a Regional Transportation Management Center to co-locate stakeholder agencies, including the NMDOT, City of Albuquerque, Bernalillo County, and NM State Police, into a single building. By housing transportation operator staff from multiple agencies in the same facility, coordination will be significantly improved, allowing optimized traffic flow and coordinated incident response for increased safety for travelers across all jurisdictions. The project is currently in the outer years of the 2014-19 Transportation Improvement Program.

e. Population Projections

Discussions about accommodating anticipated growth in this region in terms of transportation planning and decision-making are based on projected growth for the region. The source for the county level population projections is the Bureau of Business and Economic Research at the University of New Mexico (BBER).

f. Traffic Counts

Traffic counts for 2011 from MRCOG show 9,900 daily trips on Paseo del Norte at Rainbow Boulevard, rising to 12,200 trips by Golf Course Road. Unser Boulevard shows 15,200 daily trips at the Escarpment to the south, but few trips farther north.

MRCOG traffic counts anticipated for 2035 use the regional traffic model based on County-level population projections and current land-use trends. Because the model assumes a continuation of current trends, not land-use changes such as those proposed by the Volcano Heights Plan, these traffic counts should be seen as baseline numbers, which would change as land develops and transportation patterns shift.

In the Volcano Heights area, Paseo del Norte generally shows daily volumes in the range of 25,000-30,000 trips per day in each direction. [See **Table A.8.**] Peak hour traffic in the morning ranges from 2,200-2,800 heading east and 1,000-1,700 trips heading west. Peak hour traffic in the evening ranges from 2,300-3,000 trips heading west and 1,800-2,300 trips heading east.

TABLE A.8 –TRAFFIC COUNTS, 2035

	Total Daily Trips	AM Peak Hour	PM Peak Hour
Paseo del Norte	50-60,000	2,200-2,800 East / 1,000-1,700 West	1,800-2,300 East / 2,300-3,000 West
Unser Boulevard	15,000 – 25,000	600-1,200 South / 600-1,000 North	800-1,200 South / 900-1,500 North

Source: MRCOG

APPENDIX

Appendix A. Pre-existing Conditions

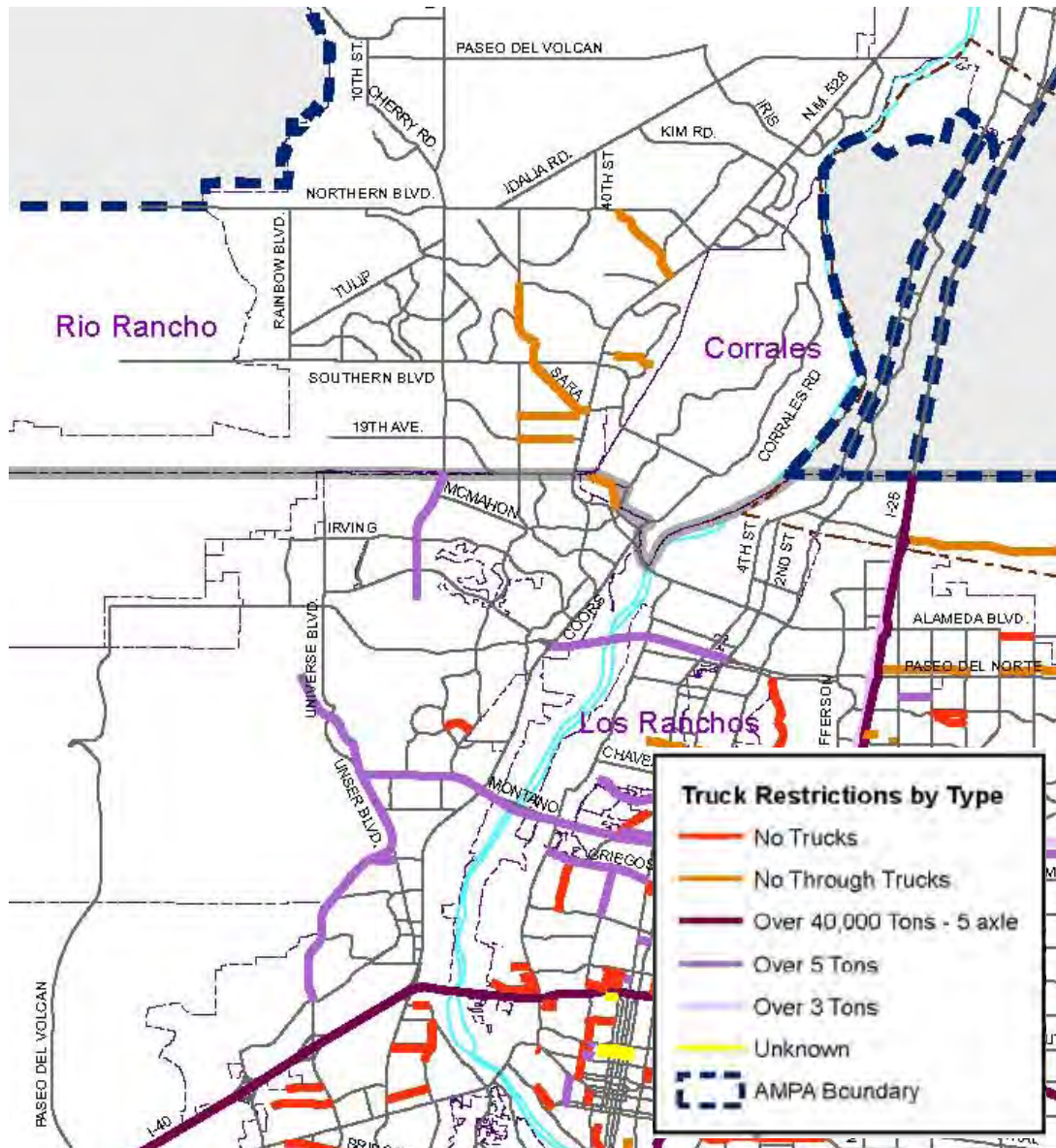

Exhibit A.29 – Truck Restrictions Map

In the same area, Unser Boulevard generally shows daily volumes in the range of 7,500-13,500 trips per day in each direction. Peak hour traffic in the morning ranges from 600-1,200 trips heading south and 600-1,000 heading north. Peak hour traffic in the evening ranges from 800-1,200 heading south and 900-1,500 heading north.

These numbers support the general perception that residents leave the area via Paseo del Norte in the morning to head east across the river and return home after work in the evenings. Traffic counts for Unser Boulevard seem to indicate that the roadway is used equally for travel north and south, with slightly higher traffic in the evenings than in the mornings, regardless of the direction of travel.

g. Truck Access

Truck restrictions are shown in **Exhibit A.29**. Truck traffic over 5 tons is prohibited on Paseo del Norte between 2nd Street and Coors Boulevard due to thin pavement and low bridges at 2nd Street and 4th Street.

Truck traffic over 5 tons is also prohibited on Unser Boulevard between Ladera Boulevard and the Escarpment, as well as north of Volcano Heights to the Albuquerque City Limits. [See **Section 13.3.9 starting on page 224.**]

Trucks are expected to access Volcano Heights via either Paseo del Vulcan, which becomes Paseo del Norte just west of the Plan area, or Paseo del Norte west of Coors.

The preferred route for truck access to Volcano Heights is I-40 to Atrisco Vista, which turns into Paseo del Norte just west of the Heights boundary.

Appendix A. Pre-existing Conditions

TABLE A.9 – CONGESTION MANAGEMENT STRATEGIES

h. Congestion Management Process

MRCOG prioritizes strategies to reduce congestion through a Congestion Management Process (CMPs) for corridors ranked by congestion level. Paseo del Norte (Paseo del Norte) was ranked 9th most congested corridor in 2008 and 3rd in 2010. Unser Boulevard was ranked 17th in 2008 and 13th in 2010.

The strategies in **Table A.9** are described in the CMP Toolkit, available on the MRCOG website. (<http://www.mrcog-nm.gov>)

2. Local Roads

As of 2011, there are no local roads constructed in Volcano Heights. (See **Section 10.7 starting on page 187** for **Secondary Street** criteria and **Exhibit 10.1 on page 163** for Primary Stre proposed by this Plan.)

There are very few opportunities to connect to local roads abutting the Plan area. These include Oakridge Street, Treeline Avenue, and Woodmont Avenue to the west, Urraca Street to the south, and Adina Lane to the north.

Congestion Management Strategies	PdN	Unser
Active Roadway Management		
Traffic signal timing and coordination	High	High
Traffic signal equipment modernization	High	High
Ramp meters	Medium	Low
Access management	High	High
Traveler information devices	High	High
Roadway signage improvements (wayfinding)	Medium	Medium
Communications networks and roadway surveillance coverage	High	High
Travel Demand Management/Alternative Travel Modes		
New fixed guideway transit travelways and dedicated transit lanes	High	High
Transit service expansion	High	High
Transit vehicle information	High	Medium
Transit intersection queue-jump lanes and signal priority	High	High
Electronic fare collection	Medium	Medium
Park & Ride facilities	High	High
Telework and flexible schedules	Medium	Medium
Ridesharing travel services	Medium	Medium
Alternative travel mode events and assistance	Medium	Medium
Off-street multi-use trails	High	High
On-street bicycle treatments	Low	High
Incident		
Incident management plans (regional and site-specific)	High	Low
Incident response and Courtesy Patrol	High	Low
Physical Roadway Capacity		
Intersection turn lanes	Medium	High
Deceleration lanes	Medium	Medium
Hill-climbing lanes	Low	Medium
Grade-separated railroad crossings	Medium	Low
HOV bypass lanes at ramp meters	Medium	Low
Roundabout intersections	Medium	Medium
New grade-separated intersections	High	Medium
New (or converted) HOV/HOT/Truck lanes	Medium	Low
New travel lanes (general purpose)	High	High
New roadways	Low	Medium

Source: MRCOG

APPENDIX

Appendix A. Pre-existing Conditions

3. Transit

As of 2013, MRCOG is conducting a feasibility study for a High-Capacity Transit Service corridor from Paseo del Norte to the Journal Center Major Activity Center near the Jefferson/I-25 intersection. Preferred alternatives for corridor alignments are expected by Summer 2013.

As of 2012, City RapidRide services the transit corridors and stops shown in **Exhibit A.30**. The Northwest Transit Center is approximately 5 miles from the Paseo del Norte / Unser Boulevard intersection.

4. Bike Paths / Trails

MRCOG's Bike and Trails Map designates bike facilities as either bike routes, bike lanes, or trails. Bike lanes are designated exclusively for bicycle travel, with bike lanes on the street separated from vehicle travel lanes with striping. (See **Exhibit A.32** for those in Volcano Mesa.) Bike lanes are typically found on arterial and collector streets, where higher traffic volumes and speeds warrant more separation for the safety of bicyclists. Bike routes are designed to accommodate autos and bikes in a shared travel lane.

According to the Albuquerque Bikeways and Trails Master Plan, May 2011, bike routes typically work best on streets with speed limits of 25 miles per hour or less and traffic volumes of 3,000 average daily trips or less. Trails are separated from travel lanes and are exclusively for use by pedestrians, bicyclists, and sometimes equestrians. Where these trails cross roadways, intersections can either be at-grade or grade separated.

Unser Boulevard and Paseo del Norte incorporate both on-street bike lanes and an off-street, multi-use trail. See cross sections in **Exhibit 10.16 on page 184** and **Exhibit 10.17 on page 185**, respectively.

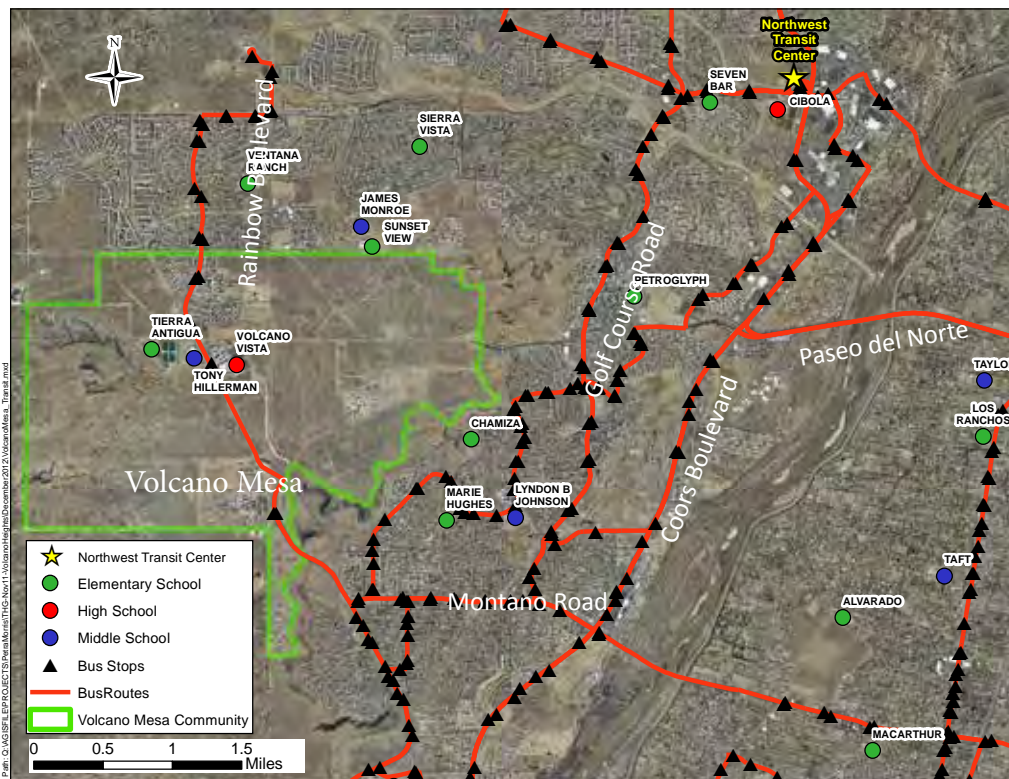

Exhibit A.30 – Pre-existing Transit Routes and Schools near Volcano Mesa

Appendix A. Pre-existing Conditions

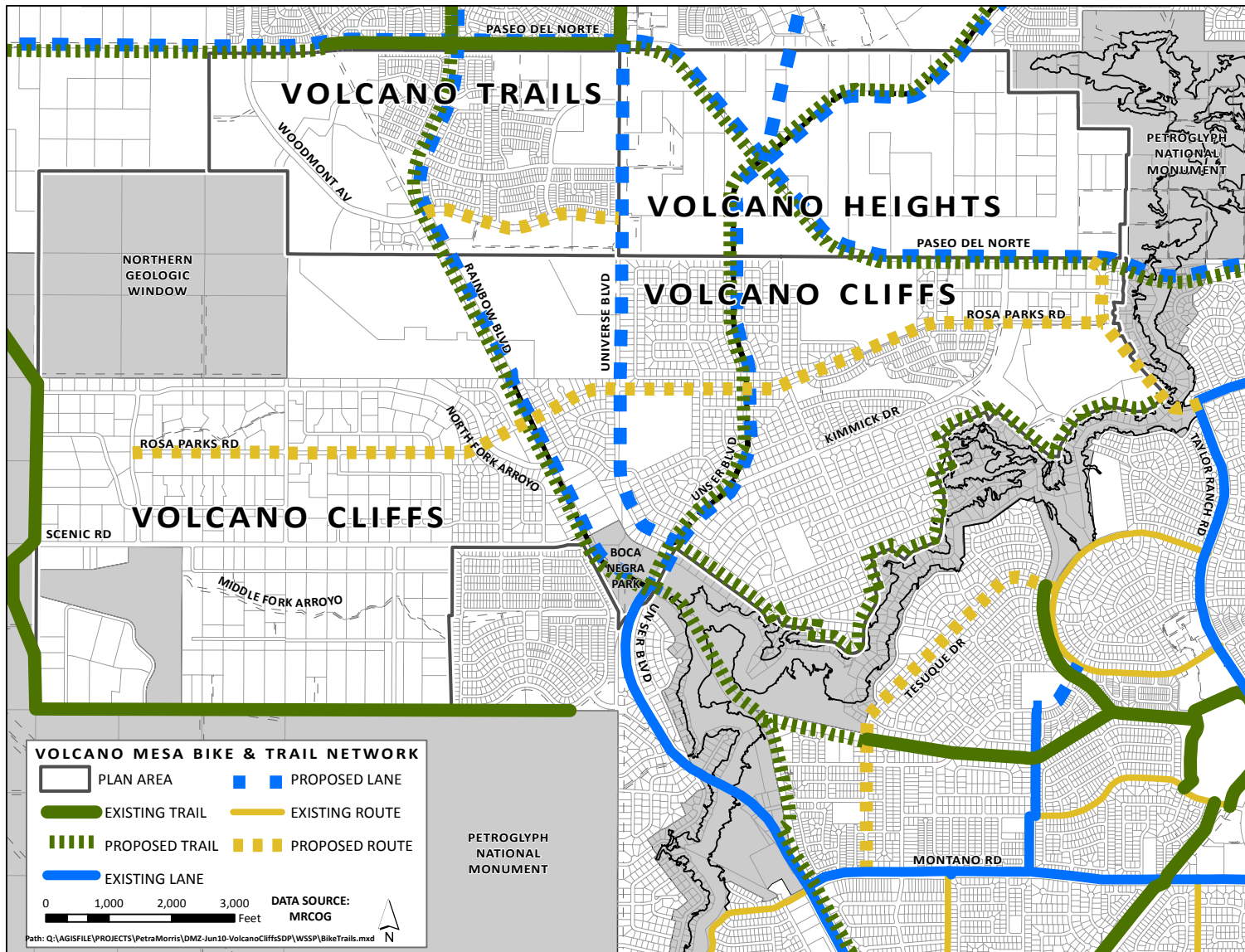

Exhibit A.32 – Volcano Mesa Bike and Trail Network Map

APPENDIX

Appendix A. Pre-existing Conditions

Mayor Berry's "Albuquerque: The Plan" proposes to construct links to connect existing bicycle trails that would create a 50-mile bike loop around Albuquerque, a portion of which would link Paseo del Norte to existing bike trails on the East Side. See **Exhibit A.31.**

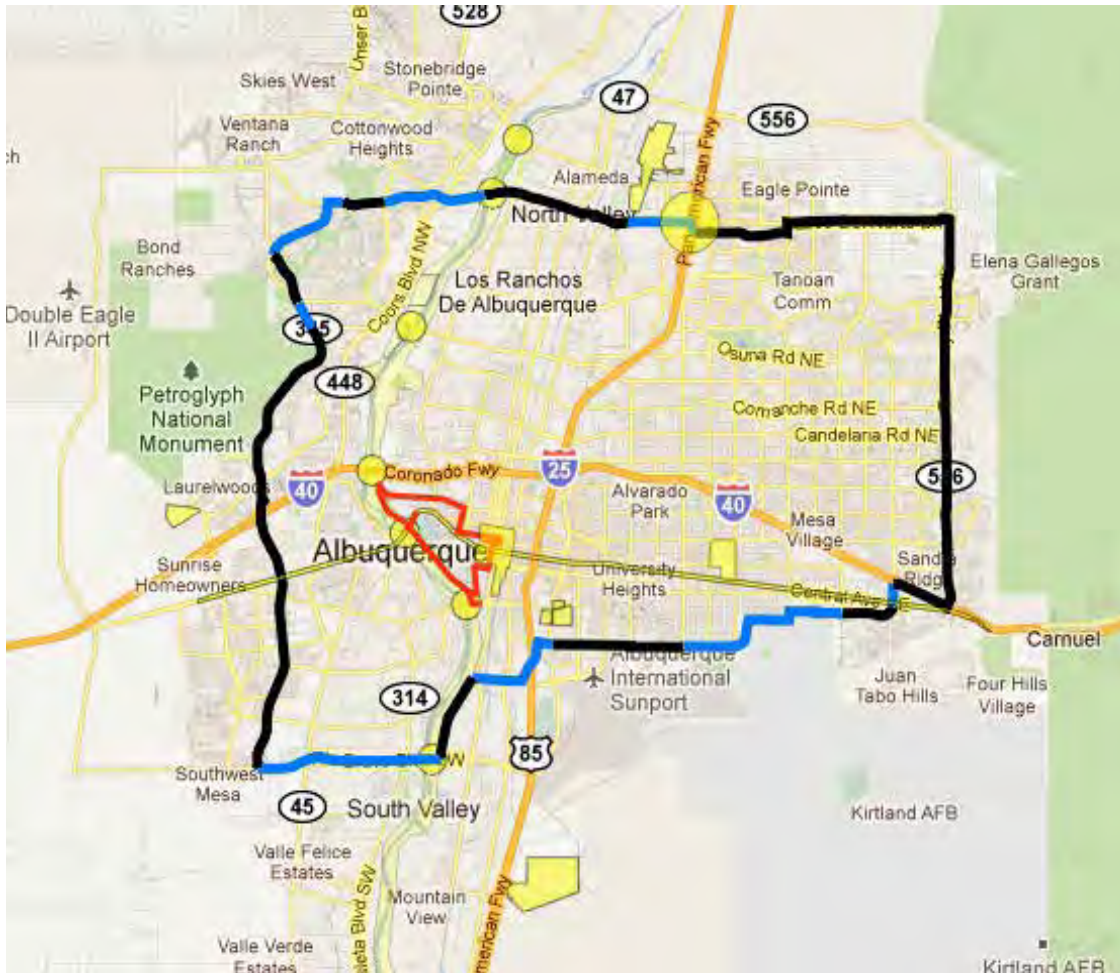

Exhibit A.31 –Mayor Berry's Proposed 50-mile Bike Loop

MRCOG's Long Range Bikeways Plan indicates a proposed bike route from Taylor Ranch Road south and west of the Plan area to Paseo del Norte, where it meets with an existing pedestrian bridge over Paseo del Norte providing access to the Petroglyph National Monument. This route offers an opportunity to extend the bike route north along the Park Edge Road and/or along a multi-use trail from the pedestrian bridge north within the Petroglyph National Monument boundary.

MRCOG's Long Range Bikeways Plan also shows a proposed bicycle route from Universe Boulevard west to Rainbow Boulevard along Woodmont Avenue within Volcano Trails. The Primary Street network for Heights extends Woodmont Avenue into Volcano Heights. A bicycle route along this corridor would link to the eventual bike lanes and multi-use trails on Unser Boulevard and Paseo del Norte, as well as continuing east to connect to the Park Edge Road and potential north/south multi-use trail on the Monument edge.

Finally, on the north boundary of the Plan area, MRCOG's Long Range Bikeways Plan shows a proposed bike lane extending north from the Unser Boulevard / Paseo del Norte intersection toward Paradise Boulevard. Because the configuration of the subdivision and roads north of the Plan boundary, the best opportunity for connection with minimal impact to existing residents might be across a property owned by the Ventana Ranch Community Association to the existing Adina Lane, which leads to Vivaldi Trail that connects to Paradise Boulevard.

Appendix A. Pre-existing Conditions

5. Commuting Patterns

Commuters within the Volcano Heights study area spent on average between 20 and 30 minutes traveling to work. (See **Table A.10.**) Albuquerque commuters had an average travel time of 20 minutes, while Rio Rancho commuters traveled an average of 30 minutes.

In all three areas, most people travel to work by car. (See **Table A.11** and **Exhibits A.33-35.**) All three areas had just over 10% of people who carpool, with Rio Rancho the highest percentage by a slight margin at 11.6%. The City of Albuquerque had the highest portion of walkers and transit takers. Volcano Heights study area and Rio Rancho were similar on both counts. Again by a slight margin, Rio Rancho had the highest percentage of people working from home, followed by Volcano Heights study area.

TABLE A.10 – AVERAGE TRAVEL TIME TO WORK, 2010

Geography	Estimate (minutes)
Census Tract 47.16	25
Census Tract 47.17	25
Census Tract 47.20	27
Census Tract 47.22	22
Census Tract 47.23	23
Census Tract 47.24	24
Census Tract 47.25	26
Census Tract 47.26	22
Census Tract 47.27	27
Census Tract 47.28	22
Census Tract 47.45	27
Census Tract 47.46	27
Census Tract 47.47	28
Census Tract 47.48	31
Census Tract 47.51	27
Census Tract 47.52	20
Census Tract 47.53	25
Census Tract 107.20	28
City of Albuquerque	21
City of Rio Rancho	29

Sources: U.S. Census Bureau, American Community Survey 2006-2010, MRCOG

APPENDIX

Appendix A. Pre-existing Conditions

TABLE A.11 - COMMUTING MODE, 2010

Mode of Transportation	Volcano Heights Study Area		City of Albuquerque		City of Rio Rancho	
	Number	Percent	Number	Percent	Number	Percent
Drove Alone (car, truck, or van)	34,197	82%	202,221	78%	30,251	80%
Carpool (car, truck, or van)	4,559	11%	28,576	11%	4,389	12%
Public Transportation (including taxicab)	361	1%	5,389	2%	346	1%
Walked and Other Means	1,013	2%	11,574	4%	957	3%
Worked at Home	1,664	4%	10,040	4%	1,732	5%
Total Workers 16 Years and Over	41,794	100%	257,800	100%	37,675	100%

Sources: U.S. Census Bureau, American Community Survey 2006-2010, MRCOG

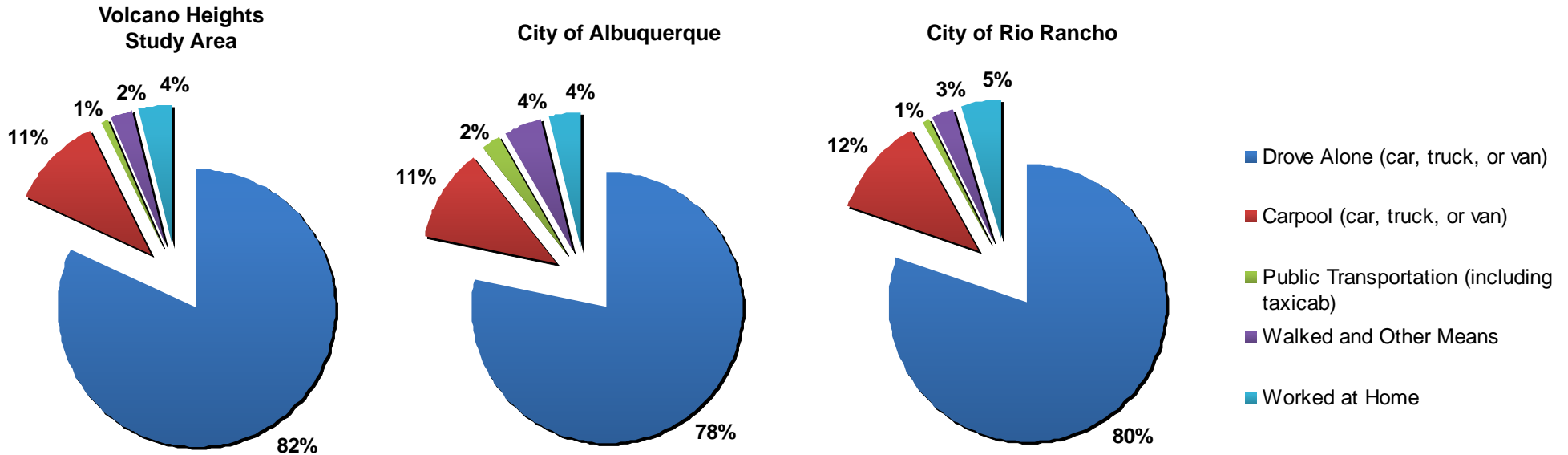

Sources: U.S. Census Bureau, American Community Survey 2006-2010, MRCOG

Exhibits A.33-35 – Commuting Modes, 2010: Volcano Heights Study Area, City of Albuquerque, and City of Rio Rancho

Appendix A. Pre-existing Conditions

E. Land Use and Urban Design

1. Pre-Existing Zoning

Land within Volcano Heights is designated by the Comprehensive Plan as Developing Urban. Prior to this Plan, the Volcano Heights Plan area was zoned primarily R-D, a zone category typically applied to newly annexed, developing areas of Albuquerque and meant as a kind of holding zone until a Sector Development Plan can be completed to provide more detailed guidance. The R-D zone, in conjunction with an approved Sector Development Plan, allows single-family dwellings, multiple family dwelling, mobile homes, and incidental commercial development to service the area based on a suburban model of development. Commercial uses are limited to 15% of the total development. See **Exhibit A.36**.

Zoning north of the Plan area includes SU-1 for C-1 with limited uses at the northeast corner of Paseo del Norte and Universe Boulevard. (See **Exhibit A.37**.) Between that zoning and the APS property with James Monroe Middle School and Sunset Elementary, there are three tracts of land with different zones. From west to east, these include:

- R-2 on the west with lots just over 1/10 acre (an average of .12 acre),
- SU-1 for Planned Residential Development (PRD) with floor-area ratio (FAR) of .5 and lots sized like R-2, and
- R-LT to the east, although the 1-acre lots have been subdivided in a way more typical of large-lot, single-family zones.

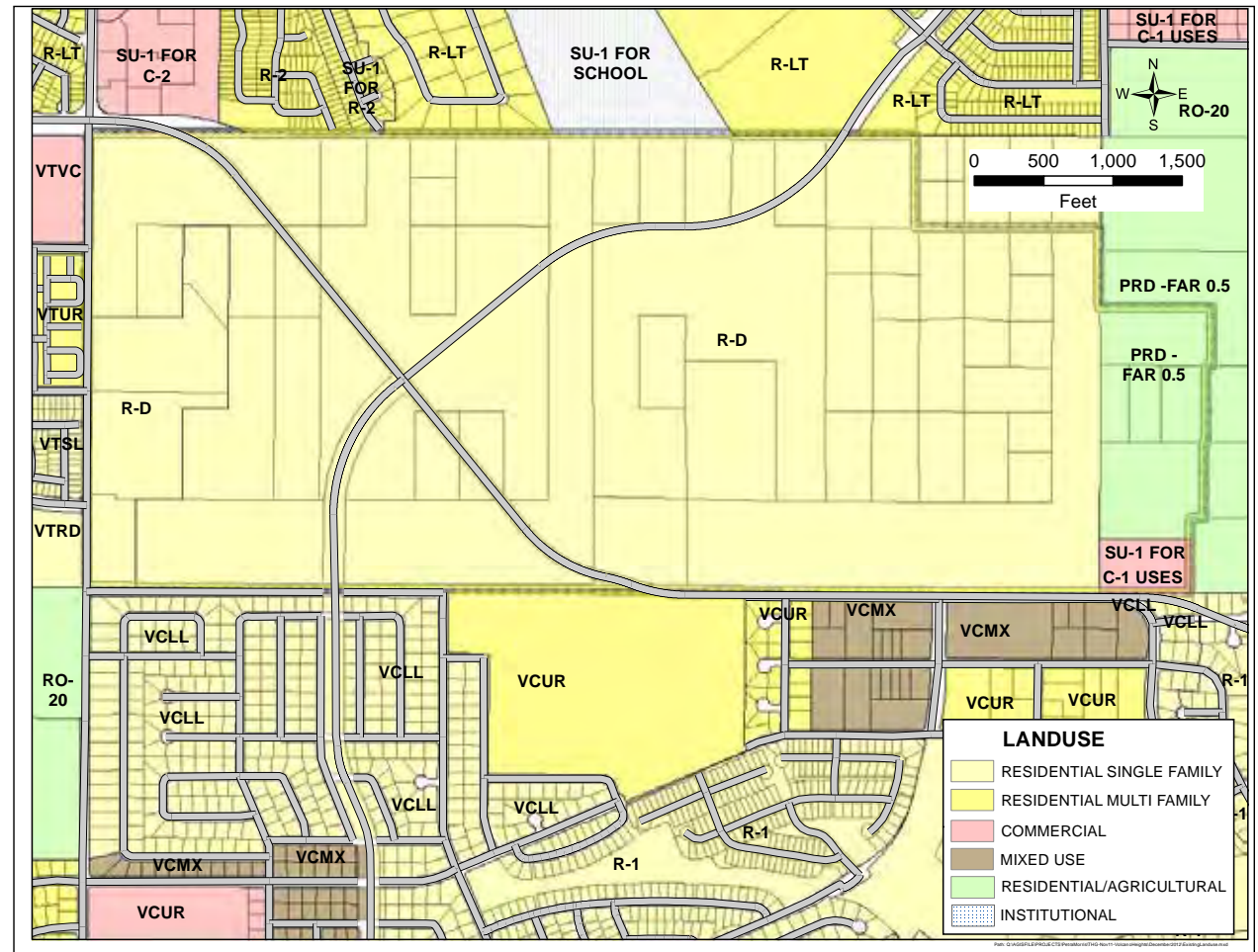

Exhibit A.36 – Pre-existing Zoning and Land Use

Appendix A. Pre-existing Conditions

East of the schools, one large tract of land is zoned R-LT. East of Unser Boulevard, the first tract of land is zoned R-LT. East of Lyon, land is zoned SU-1 for C-1.

West of the Plan area, zoning is R-LT on the northwest corner of Universe Boulevard and Paseo del Norte. The southwest corner is zoned SU-2 Volcano Trails Village Center (VTVC). Moving south, the remaining zones abutting the Volcano Heights Plan boundary are residential:

- a medium-density SU-2 Volcano Trails Urban Residential (VTUR),
- a slightly lower-density SU-2 Volcano Trails Small Lot (VTSL), and
- a low-density SU-2 Volcano Trails Residential Developing (VTRD) zone.

South of the Plan area, zoning is predominantly residential, with one mixed-use zone (SU-2 Volcano Cliffs Mixed Use - VCMX) south of Paseo del Norte near Kimmick Drive. The residential zones from west to east include the following:

- SU-2 Volcano Cliffs Large Lot (VCLL) with average lot size of 1/4 acre (.25).
- SU-2 Volcano Cliffs Urban Residential (VCUR), which is a large tract of land being master-planned as La Cuentista II, and
- SU-2 Volcano Cliffs Large Lot (VCLL) on the eastern edge of the Volcano Cliffs Plan area.

2. Pre-Existing Land Use

In general, the West Side remains predominantly single-family subdivisions served by few major arterials, leading to almost exclusive vehicle travel and congestion at peak hours. In the last 10 years, more commercial and retail has filled in along corridors, particularly at major intersections. The development pattern, limited river crossings, and imbalance of jobs on the east side of the river and housing on the West Side concentrates traffic onto few arterials. The Major Activity Center proposed for Volcano Heights is intended to provide the opportunity for major employment on the West Side to counteract the commuting pattern, mitigate congestion at peak hours, and diversify land uses on the West Side.

Land use surrounding Volcano Heights is largely residential. (See **Exhibit A.36**). The Petroglyph National Monument provides an open space and culturally rich amenity. The northeast and southwest corner of Universe Boulevard and Paseo del Norte are reserved for commercial development. Land farther north of the Plan area near Paradise and Unser Boulevards is also reserved for commercial development.

Volcano Trails and Volcano Cliffs Sector Development Plans changed zoning to encourage higher-density residential development near mixed-use and Village Center areas for neighborhood-serving commercial and retail services. This movement toward mixed use development offers support and additional opportunities for higher-density residential and more intense non-residential activity in Volcano Heights, which can support regional retail and office uses in addition to neighborhood-serving commercial land uses.

Appendix A. Pre-existing Conditions

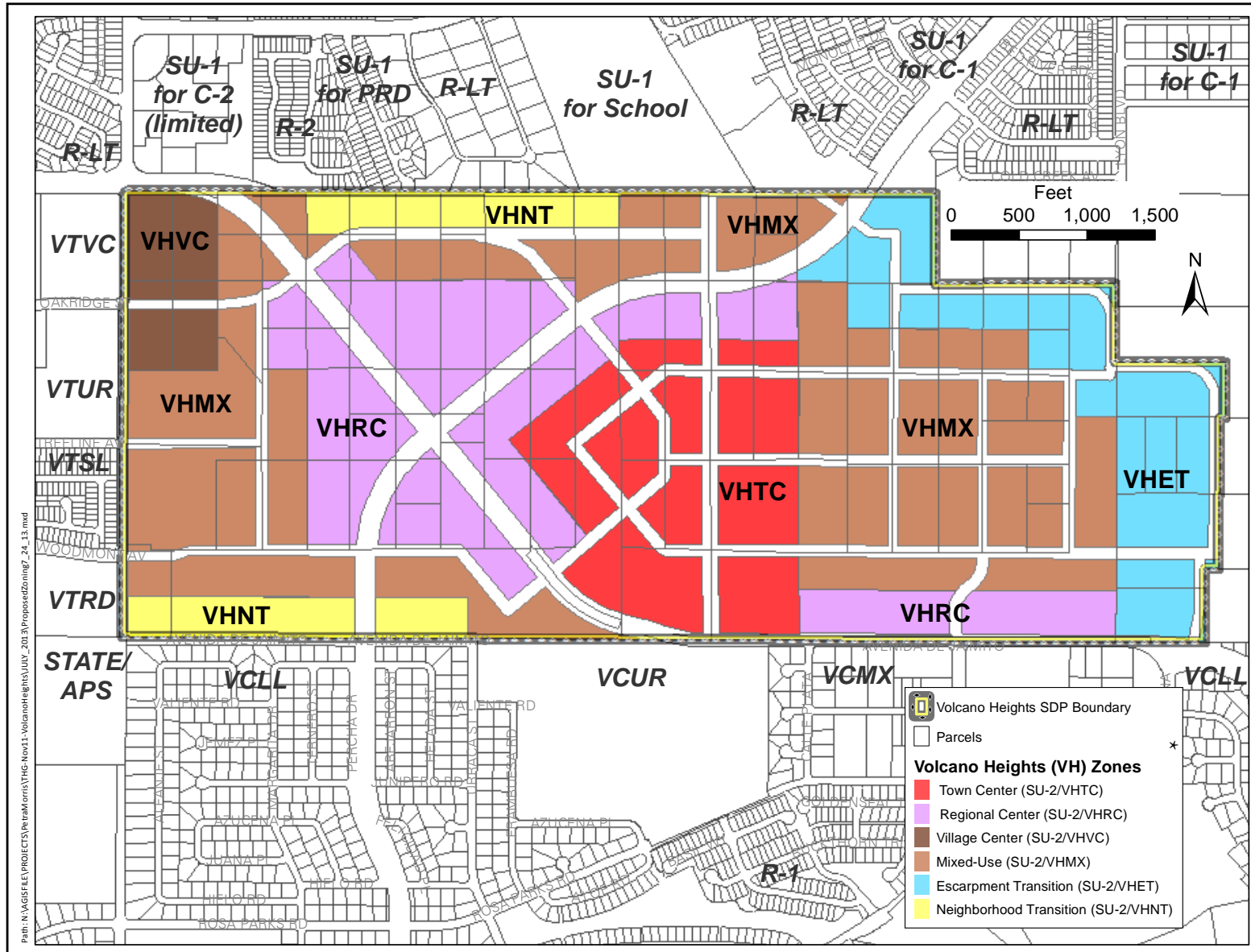

Path: N:\AGIS\FILE\PROJECTS\PetraMorris\THG-Nov11-VolcanoHeights\JULY_2013\ProposedZoningZ_24_13.mxd

* All Volcano Heights Zones are Special Neighborhood (SU-2) Zones Exhibit A.37 – Existing Zoning Surrounding the Plan Area and New Zones in Volcano Heights

APPENDIX

Appendix A. Pre-existing Conditions

3. Property Ownership

As of 2012, there are just over 30 property owners within the Plan area, which is made up of 99 unplatted properties predominantly 5 acres in size (very few are 2.5 acres, none less than 2 acres, and very few 10+ acres). See **Exhibit A.39**.

Six property owners own approximately 20 or more acres, with 1 property owner holding 45% of the land area, mostly east of Paseo del Norte. Together, these six property owners own over 75% of the Plan area. See **Exhibit A.40** and **Table A.12**.

TABLE A.12 - PROPERTY OWNERSHIP BY ACREAGE

Acres Owned	# of Owners	% of Owners	Total Acreage	% of Acreage
~20+ Acres	6	19%	432	76%
~10-20 Acres	4	13%	42	7%
~5-10 Acres	13	41%	70	12%
~ < 5 Acres	9	28%	24	4%
Total	32	100%	568	100%

Sources: AGIS, Bernalillo County Assessor, 2010

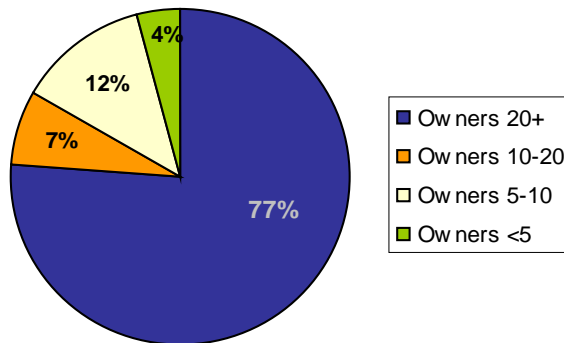

Sources: AGIS, Bernalillo County Assessor, 2010

Exhibit A.40 – Property Ownership by Acreage Chart

Appendix A. Pre-existing Conditions

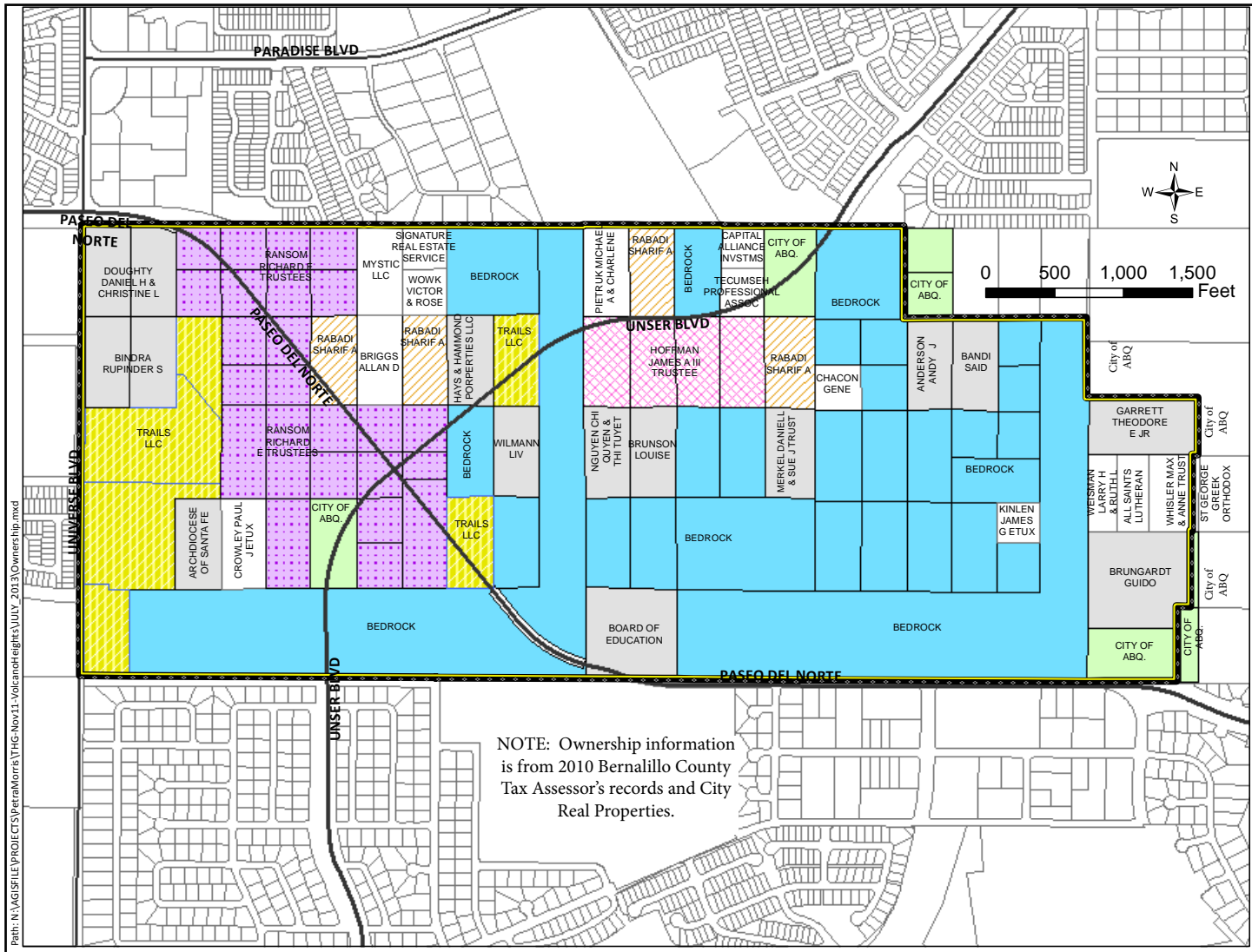

NOTE: Ownership information is from 2010 Bernalillo County Tax Assessor's records and City Real Properties.

Exhibit A.39 – Property Ownership

Appendix A. Pre-existing Conditions

F. Infrastructure

1. Volcano Heights Water & Wastewater Overview

Volcano Heights is located in the 4W & 3WR Pressure Zones within the Volcano and Corrales Service Trunks. Currently, no water or sewer infrastructure exists within the majority of the Volcano Heights study area. Any water service to this area must come from developer-funded line extensions from the surrounding areas. [See **Exhibit A.41.**]

Volcano Heights is outside the existing service areas of the Albuquerque Bernalillo County Water Utility Authority (ABCWUA). As such, any development in the study area will require the execution of a development agreement between the property owners and the ABCWUA.

a. Pre-existing Conditions – Corrales Trunk Water System

- The area north of the study area has been designated as the Corrales Trunk service area. The Corrales Trunk corresponds to the former New Mexico Utility service area.
- Water sources within the Corrales Trunk all require arsenic treatment before the water can be used in the public water system.

b. Pre-existing Conditions – Volcano Trunk Water System

- The Volcano Trunk represents the northernmost water distribution system in the ABCWUA service area prior to the acquisition of New Mexico Utilities.

- Water sources within the Volcano Trunk require arsenic treatment before the water can be used in the public water system.
- Treated San Juan Chama water is used to supplement the water sources within the Volcano Trunk.

c. Pre-existing Conditions – Wastewater

- Wastewater generated within the old New Mexico Utilities (now Corrales Trunk) service area is metered and enters the existing ABCWUA system at several metering manholes located along the Paseo del Norte corridor. [See **Exhibit A.42.**]
- For planning purposes, all of the wastewater generated within the Volcano Heights study area will be contributory to the existing sewer line in Paseo del Norte.

2. Public Service Company of New Mexico

New lines are planned primarily to increase system reliability and serve new stations. New stations and lines are planned to serve load growth in developing areas. PNM has electric facilities within the Plan area as shown in Exhibit A.41 on page A-38. There is an existing 115kV electric transmission line with an approximate right-of-way width of 100 feet on the western boundary of the Plan area and a new Scenic Substation is located west of the Unser Blvd./Rainbow Road NW intersection. [See **Exhibit A.43.**]

[Amended November 5, 2014]

Appendix A. Pre-existing Conditions

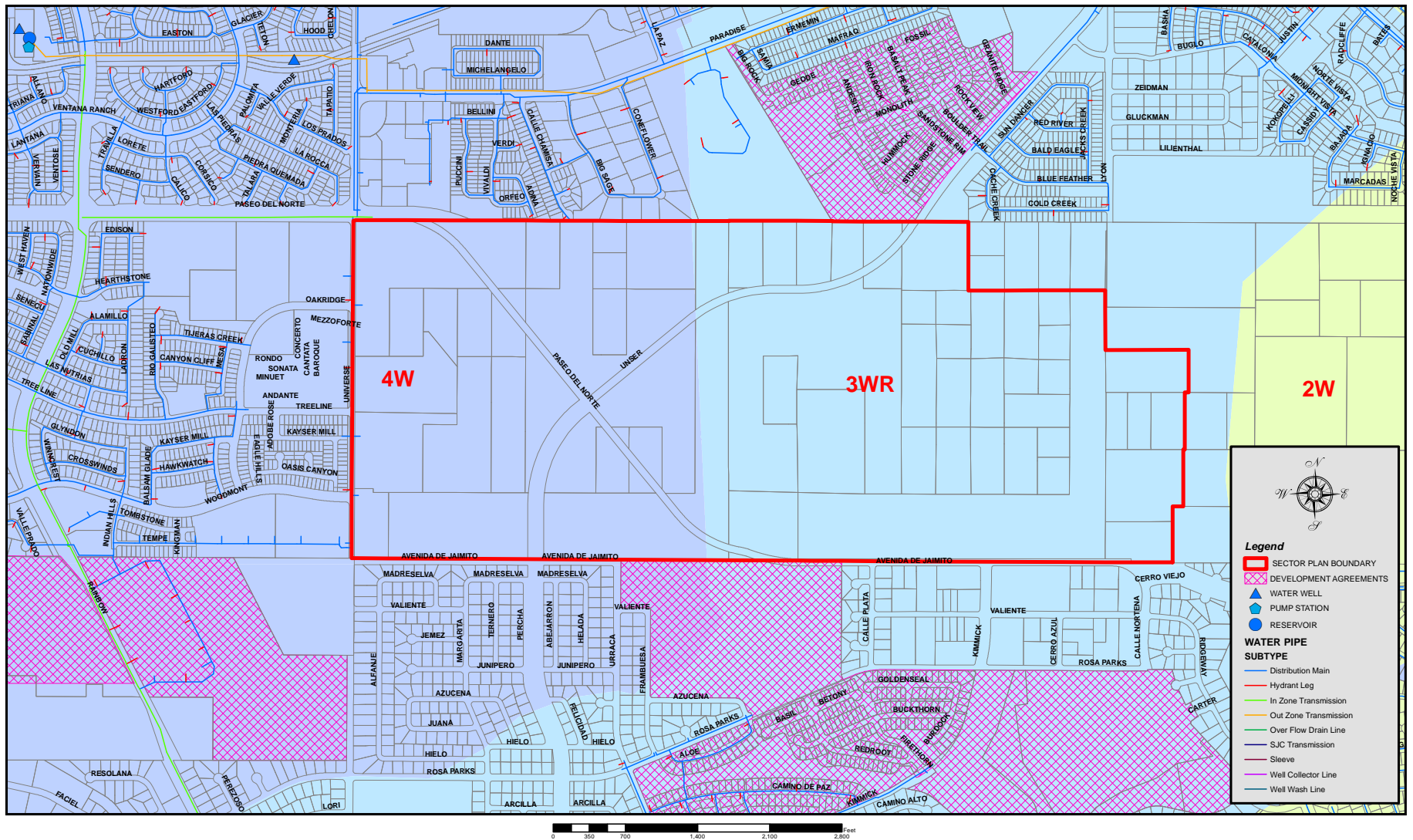

Exhibit A.41 – Existing Water Infrastructure, 2013

APPENDIX

Appendix A. Pre-existing Conditions

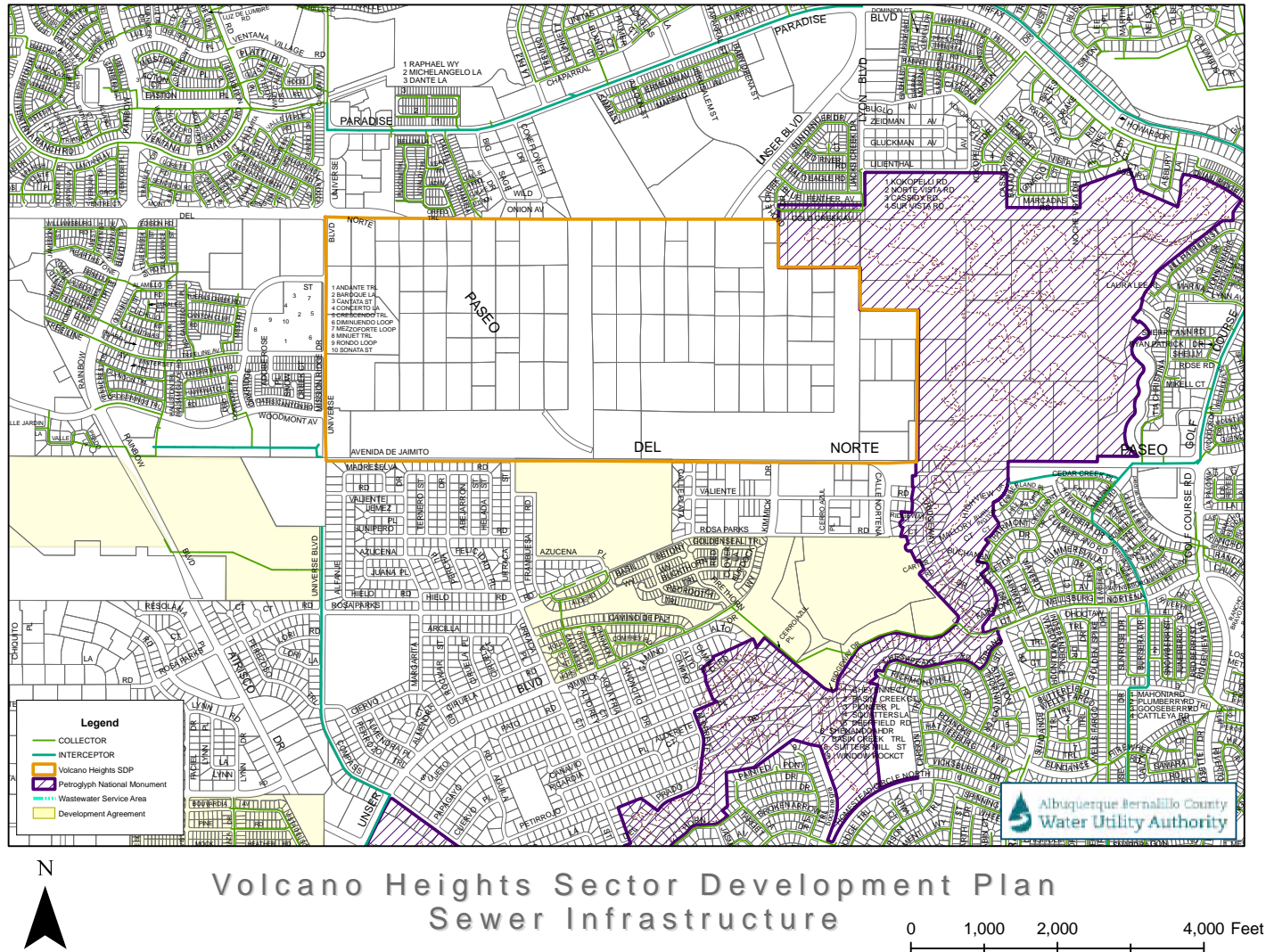

Exhibit A.42 – Existing Sewer Infrastructure, 2012

Appendix A. Pre-existing Conditions

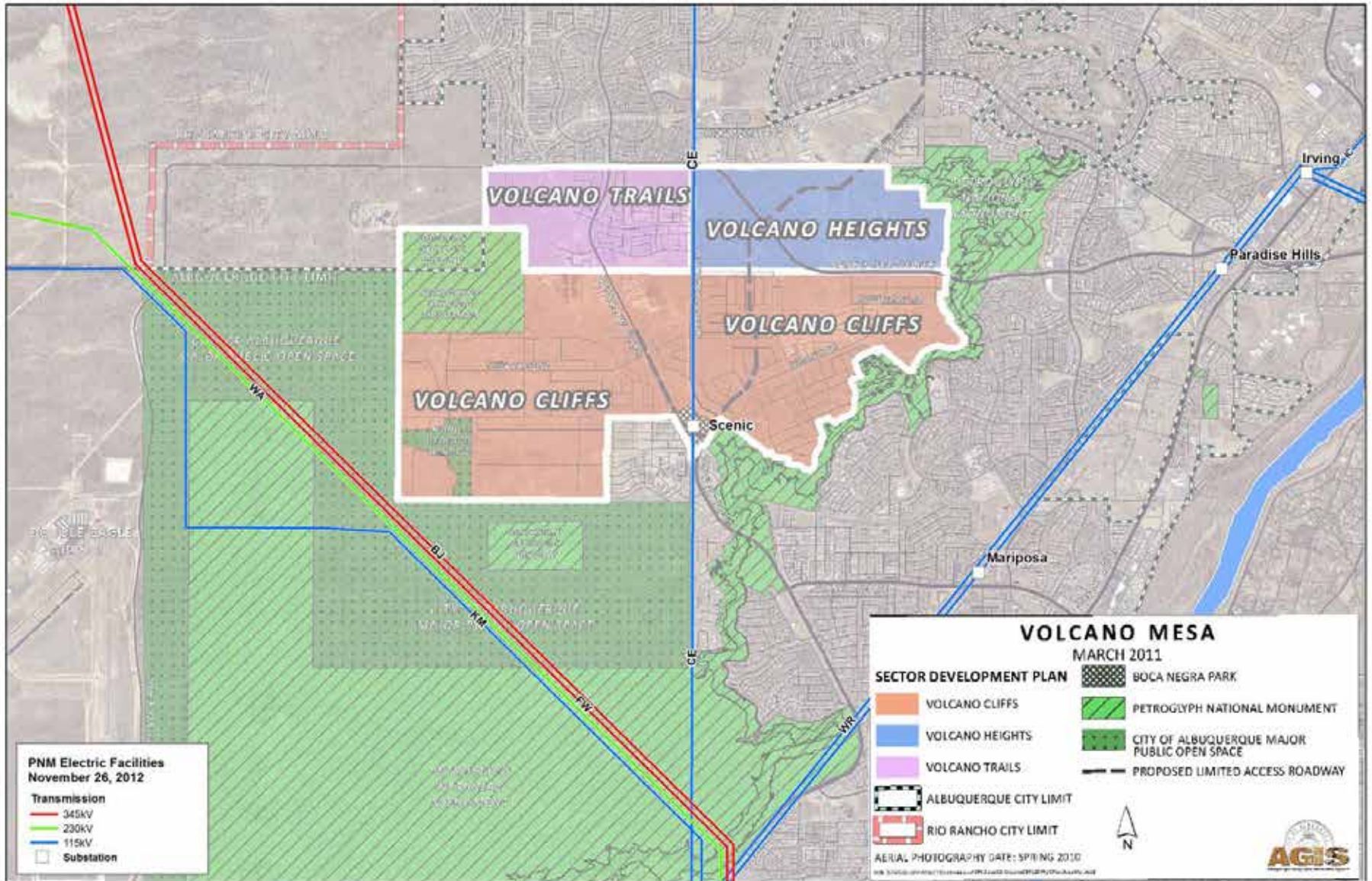

Exhibit A.43 – Volcano Mesa Area Electrical Facilities Map

This Page Left Intentionally Blank

Appendix B

Sector Planning Process

Appendix B. Sector Planning Process

In 2004, the City Council called for a planning study of Volcano Mesa, an area west of the volcanic Escarpment of the City's Northwest Mesa that includes three Sector Development Plan areas: Volcano Cliffs, Volcano Trails, and Volcano Heights.

The City Council expressed concerns over development trends with subdivisions being approved piecemeal without the guidance of an overall plan for the area, which "has long been considered a unique landscape that requires special protection." The Council recognized the need for a plan that would bring development in line with the West Side Strategic Plan (WSSP), the Northwest Mesa Escarpment Plan (NWMEP), the Albuquerque / Bernalillo County Comprehensive Plan, and other previously established policies and regulations. Issues to be addressed included transportation, drainage, water and wastewater, land uses, view corridors, building height, massing and orientation, walls, parks, trails and open space, and phasing and timing of growth.

The planning study originally forecast over 100,000 additional residents at final build-out in the Volcano Mesa plan area and adjoining areas on the Northwest Mesa and identified how the build out of exclusively single-family residential subdivisions would increase the imbalance of jobs and housing, adding to traffic demands and increasing the burden on West Side and east-west transportation systems. The study identified an overall need for transit-supportive densities and design; additional mixed-use centers; a large-scale, regional, mixed-use employment center; consolidation and connection of open space and trails along drainage channels; and retained access to exceptional views.

The City sought input from stakeholders and property owners in a renewed planning process and used that input to guide the development of the three plans that were based on the original planning effort, but more specifically tailored to the goals and visions of affected stakeholders and property owners of each area.

The planning study led to the original Volcano Heights Sector Plan, which was adopted in 2006 but appealed to district court by the Volcano Cliff Property Owners Association. Upon remand from court, the Plan was divided into three separate, but related, Rank III Sector Development Plans in order to address the diverse needs of and issues within each planning area.

In 2010, at the direction of City Councilor Dan Lewis and Planning Director Deborah Stover, in consultation with area property owners, the Planning Department and Council Services initiated a new approach to developing long-range plans for this special area of Albuquerque. Language related to the overall development of the plan area, including analysis of existing conditions and consideration and general goals and policies for land use, transportation and open space were separated into the companion "Volcano Mesa" amendment to the WSSP, the Rank II Area Plan that governs Albuquerque's West Side.

- The Volcano Cliffs Sector Development Plan (VCSDP), which includes the areas where small lots are individually owned and lower-density residential development will predominate, was adopted in May 2011.
- The Volcano Trails Sector Development Plan (VTSDP), primarily designated for medium-density, single-family residential development held in consolidated ownership, with larger tracts being developed by a master developer, Longford Homes, was adopted in August 2011.
- The Volcano Heights Sector Development Plan (VHSDP) which includes unplatted land in tracts larger than 2 acres, was designated a Major Activity Center by the WSSP Volcano Mesa Amendment. It is intended to include a mix of employment, commercial, and high- and medium-density residential development opportunities.

Appendix B. Sector Planning Process

The Volcano Heights Sector Development Plan was initially submitted to the Environmental Planning Commission in July 2010, after being developed largely by consultant Strata Design, with input from multiple property owners and stakeholders. Initial feedback indicated that some property owners had concerns that certain requirements in the Plan intended to create a dense, urban built environment were unrealistic given market conditions. Other stakeholders had concerns that the Plan would result in development that was too dense, too high, and too intense to coexist with existing residential neighborhoods to the north and south of the Plan area and protect sensitive lands near the Petroglyph National Monument in a unique volcanic, cultural, and historical landscape.

As a result of this feedback, Council Services hired Gateway Planning Group to analyze the Plan regulations to ensure that they were flexible enough to meet market conditions in the short- and long-term. Gateway worked with sub-consultant Gibbs Consulting Group to conduct a market study for office and retail uses to confirm the assumptions underlying the Plan's regulations.

The market study indicated that the original Planning study done in 2004 no longer accurately represented the reduced market potential for retail and office in this area. Gateway confirmed that certain regulations from the July 2010 Draft Plan – such as required parking structures and a minimum 2-story building height – would not provide flexibility for property owners to meet market conditions in the short- and long-term.

The planning team withdrew the July 2010 Draft Plan from the adoption process in October 2011 and worked with Gateway Planning Group, property owners, and stakeholders to rework the Plan based on the following zoning and regulation strategy:

- all mixed-use zones to allow maximum flexibility of land use to match market conditions and opportunities;
- new transition zones to ensure low-density, predominantly residential development adjacent to existing residential neighborhoods and sensitive lands;
- a smaller Town Center zone to concentrate density and create gravity for more urban development;
- a new Regional Center zone lining Paseo del Norte and Unser Boulevard to capitalize on the potential for auto-oriented development along these high-traffic volume, regional roads;
- a network of mandatory roads with frontage standards as well as mandatory building design standards for each character zone to ensure predictability of high-quality development across property lines, along corridors, and over time; and
- a bonus height strategy to balance height and density with additional protections and incentives for preserving sensitive lands.

APPENDIX

Appendix B. Sector Planning Process

The latest sector planning process included public meetings, focus groups, and workshops with property owners and stakeholders, including the following opportunities for public involvement.

Date	Meeting Type	Meeting Focus
April 14, 2011	Interviews	Several large property owners
May 23, 2011	Focus Groups	Results of the market study, analysis of 2010 Draft Plan, and potential zoning strategy changes
June 2, 2011	Public Meetings	Confirming the direction of the zoning strategy
August 23, 2011	Focus Groups	Character Zone Map and Mandatory Roads
September 14, 2011	Focus Groups	Cross Sections and Site Development and Building Design Standards
December 8, 2011	Mini-workshop	Plan Implementation with panel discussions on Economic Development and Infrastructure
March 27, 2012	Public Meeting	Open Space, Trails, Parks and Private Preservation of Sensitive Lands
August 21, 2012	Public Meeting	Results of the traffic study and key components of the Draft Plan

Appendix C

2013 Access Resolution for Paseo del Norte and Unser Boulevard and Traffic Study

This Page Left Intentionally Blank

1 RESOLUTION
2 of the
3
4 TRANSPORTATION COORDINATING COMMITTEE
5 of the
6
7 METROPOLITAN TRANSPORTATION BOARD
8 of the
9
10 MID-REGION COUNCIL OF GOVERNMENTS OF NEW MEXICO
11
12 (R-13-03 TCC)
13

14 **MODIFYING ACCESS ON PASEO DEL NORTE AND UNSER BOULEVARD**
15 **IN THE VOLCANO HEIGHTS SECTOR PLAN AREA**
16
17

18 WHEREAS, the Metropolitan Transportation Board (MTB) is the designated
19 Metropolitan Planning Organization (MPO) for the Albuquerque Metropolitan Planning Area
20 (AMPA); and

21 WHEREAS, the member agencies of the AMPA have agreed that certain roadways
22 are designated as limited access roadways; and

23 WHEREAS, the MTB per Resolution R-05-09 MTB has established *Roadway*
24 *Access Modification Policies*; and

25 WHEREAS, the *Roadway Access Modification Policies* have been implemented to
26 consider requests for access modifications to these roadways; and

27 WHEREAS, the *Roadway Access Modification Policies* designates the
28 Transportation Coordinating Committee (TCC) as the body to consider all requests to
29 modify access on Limited Access Roadways with appeal to the MTB in case of denial; and

30 WHEREAS, the Inventory of Roadway Access Limitations lists all approved access
31 locations and approved modifications (attachment A); and

32 WHEREAS, the Metropolitan Transportation Board has supported planning efforts
33 which integrate land-use policies with the transportation network; and

34 WHEREAS, the City of Albuquerque has proposed the Volcano Heights Sector
35 Development Plan which integrates land-use and transportation by creating a mixed-use
36 activity center that is supportive of high capacity transit and pedestrian walkability while
37 maintaining regional mobility for vehicular traffic; and

38 WHEREAS, the 2035 Metropolitan Transportation Plan designates a proposed bike
39 lane and multi-purpose trail along both Paseo del Norte and Unser Boulevard through the
40 Volcano Heights Sector Development Plan area; and

41 WHEREAS, the Paseo del Norte/Northwest Metro High Capacity Transit Study is
42 expected to recommend an enhanced transit service corridor between the intersection of
43 Unser Boulevard and Southern Boulevard to commercial activity centers near Jefferson
44 Street and I-25, including a connection through the Volcano Heights Sector Development
45 Plan area via a proposed "Transit Boulevard"; and

46 WHEREAS, the urban development pattern envisioned by the Volcano Heights
47 Sector Development Plan supports walking, cycling, and transit in addition to automobile
48 travel, which will require careful planning for travel movements for all transportation modes
49 across the limited access facilities; and

50 WHEREAS, the City of Albuquerque has requested a modification of access on
51 Paseo del Norte NW and Unser Boulevard NW to support development envisioned by the
52 Volcano Heights Sector Development Plan and to implement the policies established by
53 the City of Albuquerque's Rank II West Side Strategic Plan Volcano Mesa Amendment,
54 which emphasizes the importance of multi-modal connectivity within Volcano Mesa and as
55 part of the larger transportation network west of the Rio Grande as well as to serve a

56 dense, compact major activity center within Volcano Heights that provides employment and
57 new housing options on the City of Albuquerque's West Side; and

58 WHEREAS, a major activity center west of the Rio Grande is intended to help offset
59 the imbalance of jobs and housing between the metropolitan area's east and west sides;
60 and

61 WHEREAS, providing more opportunities for employment west of the Rio Grande is
62 intended to reduce the number of river crossings during peak commuter times and help to
63 minimize congestion on river crossings as well as the few key arterials west of the river;
64 and

65 WHEREAS, the intersection of Paseo del Norte and Unser Boulevard is regionally
66 significant to commuter travel; and

67 WHEREAS, the Inventory of Roadway Access Limitations contained several
68 discrepancies of access locations outside the Volcano Heights Sector Development Plan
69 area; and

70 WHEREAS, per Resolution R-05-09 MTB, the TCC is responsible for all access
71 modifications; and

72 WHEREAS, the TCC and MRCOG staff are responsible for maintaining the
73 Inventory of Roadway Access Limitations which lists all approved access locations and
74 approved modifications;

75 NOW, THEREFORE BE IT RESOLVED by the Transportation Coordinating
76 Committee of the Metropolitan Transportation Board of the Mid-Region Council of
77 Governments of New Mexico that the following modifications to access as noted in
78 Attachment A are approved; and

79 BE IT FURTHER RESOLVED that modifications to access on Unser Boulevard and
80 Paseo del Norte are approved as noted in Attachment A with the following stipulations
81 noted below.

82 1. Unser Boulevard from southern boundary of the Volcano Heights Sector Plan
83 area to Blue Feather Avenue/Boulder Trail shall have access restricted to the dedicated
84 streets listed on Attachment A with no additional driveway or vehicular access locations
85 permitted. All access to businesses, residences, etc. shall only be from the local and
86 collector streets to be built in accordance with the Volcano Heights Sector Development
87 Plan.

88 2. Paseo del Norte from Universe Boulevard to Golf Course Road shall have access
89 restricted to the dedicated streets listed on Attachment A with no additional driveway or
90 vehicular access locations permitted. All access to businesses, residences, etc. shall only
91 be from the local and collector streets to be built within the Volcano Heights Sector
92 Development Plan area.

93 3. The intersection of Paseo del Norte and Unser Boulevard shall be reviewed for
94 the construction of a grade separated interchange at such time as traffic congestion and
95 development conditions warrant such review.

96 a). As soon as practical and financially feasible, the TCC shall encourage
97 appropriate agencies to secure funding for the purchase of the necessary
98 rights-of-way to preserve the minimal amount of land required for such a
99 future interchange based on an estimate acceptable to the New Mexico
100 Department of Transportation, the City of Albuquerque and Bernalillo County.

101 b). Upon recommendation to construct a grade-separated interchange, the TCC, as
102 the committee responsible for the development of the Transportation

103 Improvement Program (TIP), shall review funding options for the design and
104 construction of an urban, multi-modal, grade separated interchange which
105 shall accommodate cyclists, pedestrians, transit movements and vehicular
106 traffic in all travel directions and incorporates best practices for multi-modal
107 design.

108 c). The grade-separated interchange will be designed to complement the urban
109 development pattern envisioned by the Volcano Heights Sector Development
110 Plan and minimize impact on surrounding development, adjacent roadways,
111 and nearby trails and open space.

112 4. The first intersection on Unser Boulevard south of Paseo del Norte (approximately
113 1,027 feet south) shall remain unsignalized until such time as a grade separated
114 intersection at Paseo del Norte and Unser Boulevard is constructed and shall be designed
115 to accommodate safe crossings for pedestrians and cyclists.

116 5. The intersection of the proposed transit boulevard and Paseo del Norte (located
117 approximately 2,695 feet east of Unser Boulevard) is approved for a "High-T" intersection
118 which, to the extent practical, preserves the eastbound-through, free-flow movement on
119 Paseo del Norte with a dedicated eastbound to northbound left-turn lane and a southbound
120 to eastbound left-turn lane combined with an eastbound merge lane, in order to minimize
121 traffic signal phasing and cycle length and to minimize red-signal time for Paseo del Norte.

122 a). Until such time as Paseo del Norte is constructed to a four or six lane facility and
123 the "High-T" intersection is constructed, the intersection may be constructed
124 as a traditional at-grade, signalized intersection.

125 PASSED, APPROVED, AND ADOPTED this 12th day of July 2013 by the
126 Transportation Coordinating Committee of the Metropolitan Transportation Board of the
127 Mid-Region Council of Governments of New Mexico.

128
129
130
131
132
133
134
135
136
137
138
139
140
141

George Bootes, Chairman
Transportation Coordinating Comm.

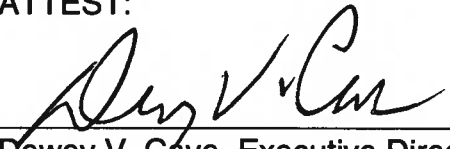
ATTEST:

Dewey V. Cave, Executive Director
Mid-Region Council of Governments

Refer to R-13-03 TCC Attachment A for listing of all approved access modifications revised by this resolution.

R-13-03 TCC Attachment A

Inventory of Roadway Access Limitations

Some arterial roadways in the Albuquerque Metropolitan Planning Area (AMPA) have a greater degree of access limitations in order to increase their primary function of moving large volumes of traffic. It is intended that the local government represented on the Metropolitan Transportation Board (MTB) which has jurisdiction over the adjacent land and/or affected facility will coordinate access to lands along that facility. It is further intended that, for those facilities under the jurisdiction of the State of New Mexico, the responsible local government shall coordinate the proposed actions with the New Mexico Department of Transportation. In either case, it is expected that the local government with jurisdiction over adjacent land will notify all affected property owners of record as to the nature of the limitations proposed and of the process by which the policy will be maintained or modified.

The original access limitations for proposed and existing facilities were established by resolution of the MTB. The resolution number(s) is shown within parenthesis after each facility name.

On August 25, 2005, the Metropolitan Transportation Board approved resolution **R-05-09 MTB**. The resolution established the Access Limitations as a stand-alone policy separate from the FAABS, adopted a procedure for modifying access points, and delegated authority to the Transportation Coordinating Committee (TCC) to implement access policy and approve variances from that policy.

KEY

Proposed changes in blue text in yellow shading are those modifications due to the Volcano Heights Sector Development Plan.

Proposed changes in red text are those modifications to correct discrepancies and are **NOT** due to the Volcano Heights Sector Development Plan.

Coors Boulevard (NM 45 part)

A. Coors Boulevard (R-81-07, R-84-06, R-84-09, R-86-07, R-86-22, R-93-11, R-95-2, R-95-21, R-01-24, R-03-02, R-05-15, R-13-01) Primary access to Coors Boulevard from Arenal Road to N.M. 528 is as described below. Right-in/right-out and driveway accesses are described in the Coors Corridor Plan. Additional restrictions may be imposed as per the adopted Coors Corridor Plan.

1. Arenal Road to Central Avenue	As currently (July 1986) designed
	a. Central Avenue (full intersection)
	b. Bluewater Road (full intersection)
	c. Fortuna Road (full intersection)
	d. Hanover Road (full intersection)
	e. I-40 Interchange (full intersection)
	f. Los Volcanes Road (full intersection)
	g. Quail Road (full intersection)
	h. Sequoia Road (full intersection)
	i. St. Joseph's Drive (full intersection)
	j. Western Trail (full intersection)
	k. Southerly portion of La Luz (full intersection)
	l. Dellyne Avenue (full intersection)
	m. Montañó Road (full at-grade intersection; future interchange)
	n. Montañó Plaza Drive (full intersection)
2. Central Avenue to N.M. 528	o. 1,400 feet south of Montañó (left in) R-05-15
	p. La Orilla Road (full intersection)
	q. Roberson Lane (left-in from southbound Coors Blvd) R-13-01 TCC
	r. Midpoint between El Malecon and La Rambla (access to the east only)
	s. Eagle Ranch Road (full intersection)
	t. Paseo del Norte (interchange)
	u. Irving Boulevard (full intersection)
	v. Coors By-Pass (interchange)
	w. Coors Bypass - northerly entrance to Cottonwood Mall (left-in/right-in/right-out access only)
	x. Eagle Ranch Road - intersection with Coors By-Pass (full intersection)
	y. Seven-Bar Loop Road - intersection with Coors By-Pass (full intersection with right turns only from Seven-Bar Loop Road)
	z. Ellison Drive - intersection with Coors By-Pass Road (interchange)
	aa. N.M. 528 - intersection with Coors By-Pass (interchange)

Gibson Boulevard

B. Gibson Boulevard (R-86-5, R-86-9, R-89-15, R-90-11, R-91-9, R-96-4, R-95-21, R-03-11, R-03-31, R-04-04, R-07-03 TCC, R-07-04 TCC)

1. I-25 to San Mateo Boulevard	High-capacity, high-speed, limited access Principal Arterial	b. Use by heavy trucks is restricted.										
		c. I-25 frontage road (east side) to Mulberry - No access allowed										
		a. Full access is limited to the following approximately one-half mile at-grade intersections										
		c. Partial access is limited to the following locations:										
		<table style="width: 100%; border-collapse: collapse;"> <tr><td style="border: none;">1) I-25 frontage Road</td></tr> <tr><td style="border: none;">2) Midway between Mulberry and University - T intersection to the north</td></tr> <tr><td style="border: none;">3) University Boulevard</td></tr> <tr><td style="border: none;">4) Yale Boulevard</td></tr> <tr><td style="border: none;">5) Girard Boulevard</td></tr> <tr><td style="border: none;">6) San Mateo Boulevard</td></tr> <tr><td style="border: none;">1) Mulberry - right-in/right-out/left in</td></tr> <tr><td style="border: none;">2) Wellesley-south side-right-in/right-out/left in</td></tr> <tr><td style="border: none;">3) Midway between Yale and University Boulevard - right-in, right-out to the south</td></tr> <tr><td style="border: none;">4) North side of Gibson approximately 800 feet east of University Avenue right-in/right-out R-07-04 TCC</td></tr> </table>	1) I-25 frontage Road	2) Midway between Mulberry and University - T intersection to the north	3) University Boulevard	4) Yale Boulevard	5) Girard Boulevard	6) San Mateo Boulevard	1) Mulberry - right-in/right-out/left in	2) Wellesley-south side-right-in/right-out/left in	3) Midway between Yale and University Boulevard - right-in, right-out to the south	4) North side of Gibson approximately 800 feet east of University Avenue right-in/right-out R-07-04 TCC
1) I-25 frontage Road												
2) Midway between Mulberry and University - T intersection to the north												
3) University Boulevard												
4) Yale Boulevard												
5) Girard Boulevard												
6) San Mateo Boulevard												
1) Mulberry - right-in/right-out/left in												
2) Wellesley-south side-right-in/right-out/left in												
3) Midway between Yale and University Boulevard - right-in, right-out to the south												
4) North side of Gibson approximately 800 feet east of University Avenue right-in/right-out R-07-04 TCC												
2. San Mateo Boulevard to Louisiana Boulevard	Principal Arterial with full access limited to approximately one-quarter mile intervals, right-in/right-out driveway access allowed, and provision for emergency vehicle access where required											
3. Louisiana to Juan Tabo Boulevard	a. High-capacity, high-speed, limited access Principal Arterial with access limited to approximately one-half mile at-grade intersections.	1) Eubank Boulevard										
		2) Elizabeth Street										
		3) Juan Tabo Boulevard										
	b. Right-in/right-out access at one-quarter mile intervals if required	1) Eubank Boulevard to Elizabeth Street at approximately one-quarter mile intervals both north and south (right-in/right-out access)										
	2) Elizabeth Street to Juan Tabo Boulevard at approximately one-quarter mile intervals both north and south (right-in/right-out access)											
	c. Shall follow the north alignment and lie entirely on KAFB property to Eubank Boulevard East of Eubank Boulevard the corridor will follow and encompass existing Southern Boulevard	1) Southern Avenue at Stephen Moody (right-in/right-out/left-in) R-07-03 TCC										

Juan Tabo Boulevard

C. Juan Tabo Boulevard (R-86-9, R-91-09)

1. Gibson Boulevard to I-40	Full access only at Central Avenue and I-40
2. Intersection of Skyline Road and Juan Tabo Boulevard	T-intersection to the east with a median opening

McMahon Boulevard

D. McMahon Boulevard (R-2000-11, R-05-10)

Access is provided for full intersections along McMahon Boulevard at approximately 1000 foot intervals. Access is provided for T intersections and right-in/right-out driveways provided they are no closer than approximately 400 feet to adjacent intersections.

Right-in, Right out access at:	1. Approx. 370 feet west of Golf Course Rd R-05-10 MTB
--------------------------------	---

Montaño Road

E. Montaño Road (R-80-5, R-84-9, R-86-14)

No access shall be permitted between Coors Boulevard and just east of Rio Grande Boulevard

Paseo del Norte (NM 423)

F. Paseo del Norte (R-85-3, R-86-8, R-86-15, R-86-17, R-86-24, R-88-6, R-01-24, R-03-26, R-05-13, R-06-01 TCC, **R-13-03 TCC**)

A potential future freeway type facility from Coors Boulevard to Louisiana Boulevard, Paseo del Norte shall be a limited access Principal Arterial. Access to Paseo del Norte ~~shall be permitted only as specified by resolution of the MTB and~~ shall be limited to one of the following three types of interchange intersections. These three types are defined and locations of access are specified below.

TYPE A: Interchange configuration

TYPE B: At-grade dedicated street intersection with median opening

TYPE C: At-grade dedicated street intersection without median opening

TYPE A: Interchange configuration	1. Paseo del Volcan - NM347 (initially at-grade; future grade-separation as needed) R-13-03
	2. Unser Boulevard (future grade-separation) R-13-03 TCC
	3. Coors Boulevard
	4. 2nd Street
	5. Jefferson Street (grade-separation under project CN A301180) R-13-03 TCC
	6. I-25
TYPE B: At-grade dedicated street intersection with median opening and traffic signalization, as warranted. At approximately one-half mile intervals, or as identified on the Long Range Roadway System, and specifically located at the following intersections. Additional Type B intersections may be permitted if they subsequently are added to the Long Range Roadway System and meet the approximate one-half mile interval criteria.	1. Atrisco Vista Blvd. (formerly Paseo del Volcan East & Double Eagle II Rd.)
	2. Boulevard del Oeste, extended
	3. Woodmont Avenue-Ventana West Parkway R-06-01 TCC
	4. Rainbow Boulevard
	5. Universe Boulevard
	6. A new street approx. 1,550 feet east of Universe Blvd. and 1,518 feet west of Unser Blvd. R-13-03 TCC
	7. Unser Boulevard (at-grade until future grade-separation is needed) R-13-03 TCC
	8. A new street approx. 1,410 feet east of Unser Blvd R-13-03 TCC
	9. A new street (aka "Transit Blvd" in Volcano Heights Sector Plan) approx. 2,695 feet east of Unser Blvd and 1,816 feet west of Kimmick Dr. This intersection is approved for a "High-T" type of intersection which, to the extent practical, preserves the eastbound-through, free-flow movement, and a dedicated eastbound to northbound left-turn lane along with a southbound to eastbound left-turn lane including an eastbound merge lane, in order to minimize traffic signal phasing and cycle length for Paseo del Norte to minimize red-signal time. R-13-03 TCC
	10. Kimmick Drive
	8. Taylor Ranch Corridor (T-intersection to the south)
	11. Golf Course Road
	12. Unnamed Collector midway between Eagle Ranch Road and Golf Course Road (now called Rancho Sereno Road & Richland Hills Road)
	13. Eagle Ranch Road
	12. Jefferson Street
	14. San Pedro Drive
	15. Louisiana Boulevard
	16. Wyoming Boulevard
	17. Barstow Street
	18. Ventura Street
	19. Holbrook Street
	20. Eubank Boulevard
	21. Browning Street
22. Lowell Street	
23. Tramway Blvd	
TYPE C: At-grade dedicated street intersection <u>without</u> median opening	1. Calle Plata (right-in/right-out only on south side of Paseo del Norte) R-13-03 TCC
	2. Calle Norteña (right-in/right out only on south side of Paseo del Norte) R-13-03 TCC
	3. Park Edge Drive, a new street approx. 1,723 feet east of Kimmick Dr. (right-in/right-out only on north side of Paseo del Norte) R-13-03 TCC
	4. Mid block between Wyoming & Barstow (right in/right out) R-05-13 MTB
	5. Rancho de Palomas (south side of Paseo del Norte between Wyoming and Louisiana)
	6. Between I-25 and San Pedro Boulevard, to serve the south side parcel to and from Paseo del Norte
Access Prohibition	Access Prohibition: Paseo del Norte between Universe Boulevard and Golf Course Road shall have access restricted to the dedicated streets granted access above with no additional driveways or vehicular access locations permitted. All access to businesses, residences, etc. shall only be from the local and collector streets existing or to be built. R-13-03 TCC

Paseo del Volcan (NM 347)

G. Paseo del Volcan Western Alignment (R-82-12, R-86-22, R-90-13, R-93-8, R-03-17)

A high-speed, high-capacity, limited access principal arterial from I-40 on the south to US550. It is the desire of the MTB that Paseo del Volcan shall ultimately be developed to freeway standards and that ultimate access shall be provided via interchanges at approximately 1 mile intervals. Prior to ultimate development, at-grade intersections with median openings at other than one-mile intervals may be permitted **when approved by the MTB**. When ultimate access control on Paseo del Volcan is implemented, reasonable access will be provided to adjacent properties. An access control plan for adjacent and intersecting streets shall be developed through subsequent location corridor studies. The following access policy has been established.

I-40 on the south to US550 on the north Limited to approximately one-mile intervals, as follows:	1. Approximately 1.4 miles north of I-40
	2. Approximately 2.5 miles north of I-40
	3. Approximately 3.6 miles north of I-40
	4. Approximately 4.6 miles north of I-40, on the north boundary line of the Town of Atrisco Grant
	5. Approximately 7.8 miles north of I-40, on the south boundary line of the Town of Alameda Grant
	6. Approximately 9.6 miles north of I-40, at proposed Paseo del Norte
	7. Approximately 10.7 miles north of I-40
	8. 19th Avenue
	9. Southern Boulevard
	10. West Sandia Boulevard
	11. Northern Boulevard
	12. 19th Avenue North
	13. Vista Road
	14. Rainbow Boulevard
	15. 20th Street (Unser Boulevard)
	16. 30th Street
	17. 40th Street
	18. Iris Road
	19. Lincoln Avenue
	20. Approximately 1.1 miles north of Lincoln Avenue

Atrisco Vista Boulevard

(formerly Double Eagle II Road or Paseo del Volcan Eastern Alignment)

H. Atrisco Vista Boulevard (Paseo del Volcan Eastern Alignment) (R-03-17, R-04-01, R-13-03 TCC)

A high-speed, high-capacity, limited access principal arterial from the southern terminus at Senator Dennis Chavez Boulevard to the northern terminus at Southern Boulevard in Rio Rancho. The purpose of Paseo Del Volcan (Eastern Alignment) is to provide a relatively high-speed regional roadway connecting Paseo Del Norte with I-40, reasonable direct access to the Double Eagle II Airport from both Paseo del Norte and I-40, and limited but viable access to commercial and residential properties adjacent to the roadway. The following access policy has been established:

1. Senator Dennis Chavez Boulevard to I-40.	a. Full intersection permitted at:	1). Senator Dennis Chavez Boulevard R-13-03 TCC 2). Tierra West Estates Road approx. one-half (½) mile south of Central Ave.
	b. Access between Tierra West Estates Road and Senator Dennis Chavez Boulevard shall be provided for full intersections at approximately one half mile intervals and for "T" intersections and right-in/right-out driveways at approximately one-quarter mile intervals.	
2. I-40 to Double Eagle II Airport southern boundary.	a. No intersections and/or driveways permitted between I-40 and 1/2 mile north of I-40	1) 3,460 feet north of I-40 2) Ladera Drive 3) 118th Street 4) 98th Street 5) Upper Street
	b. Full intersection permitted only at:	
	c. "T" intersections and right-in/right-out driveways permitted at approximately one-quarter mile intervals between 1/2 mile north of I-40 and Double Eagle II Airport, as follows:	4,580 ft north of I-40 - right-in/right-out
3. Double Eagle II Airport southern boundary to Double Eagle II Airport northern boundary.	No access permitted except as prescribed by the Double Eagle II Airport Master Plan.	
4. Double Eagle II Airport northern boundary to Southern Boulevard in Rio Rancho.	a. Full intersection permitted only at:	1). Paseo del Norte R-13-03 TCC 2). Southern Boulevard R-13-03
	Access shall be provided for "T" intersections and right-in/right-out driveways at approximately one-quarter mile intervals.	

Rio Bravo Boulevard & Sen. Dennis Chavez Blvd. (NM 500)	
I. Rio Bravo (R-85-13, R-86-9, R-86-31, R-88-8, R-90-5, R-01-24, R-05-11, R-05-14, R-10-01, R-12-02 TCC & R-12-10 MTB) A high-speed, high-capacity limited access Principal Arterial between I-25 and Paseo del Volcan Western alignment	
<p>1. Full interchange, at-grade Street intersections shall occur at one-half mile intervals and shall be limited to at-grade street intersections with median openings and traffic signalization, as warranted, or interchange configurations. These intersections shall be located at the identified locations. Additional at-grade street intersections with median openings or interchanges may be permitted at approximately one-half (½) mile intervals if added to the Long Range Roadway system.</p>	a. Paseo del Volcan (aka NM 347)
	b. Atrisco Vista Boulevard (formerly Paseo del Volcan)
	c. 118th Street
	d. 98th Street
	e. Unser Boulevard
	f. Condershire Drive
	g. Coors Blvd
	h. Sunstar Drive
	i. La Junta Drive
	j. Del Rio Road
	k. Isleta Boulevard
	l. Poco Loco Drive
	m. 2nd Street
	n. Prince Street
	o. Broadway Boulevard
p. University Boulevard	
q. San Mateo Blvd	
<p>2. I-25 to Coors Boulevard SW: Right-in/right-out access may be permitted without median openings approximately one-fourth (¼) mile from the nearest permitted intersection if special conditions are demonstrated and the location of such access points is approved by the MTB.</p>	a. Access to eastbound Rio Bravo Boulevard, just east of the San Jose Drain between 2nd and Prince Street.
	b. Approximately 660 feet west of Coors Blvd, right in/right out/left in R-06-03 TCC
	c. Westbound right turn deceleration lane between Prince Street and 2nd Street; TRANSIT ONLY left in/right out R-07-01 TCC
	d. A right-in/right-out on the north side of NM 500 between the South Diversion Channel and NM 47 with deceleration lane as far west as practical. R-12-02 TCC & R-12-10 MTB
	e. Approximately 250 feet east of Broadway Blvd. Right-turn in only is permitted on north side of Rio Bravo
	f. Approx. 400 feet east of Broadway (right in/right out) R-05-11 MTB
	g. 1,130 feet east of Broadway (right in/right out/ left in) R-05-14 MTB
4. Loris Drive (along the west side of Isleta Drain)	T-intersection is allowed
5. Approximately midway between 98th and 118th	T-intersection is allowed for access to the south for Atrisco Heritage Academy High School Events Field.

San Mateo Boulevard	
J. San Mateo Boulevard (R-86-9, R-86-14, R-86-22) Access to San Mateo Boulevard between I-40 and the Rio Bravo East Extension Corridor shall be as listed below.	
1. I-40 to Zuni Road	As currently (July 1986) provided
2. Zuni Road to Gibson Boulevard	a. As shown in the final design.
	b. Northbound directional left-turn median opening between Kathryn Avenue and Southern Avenue
3. Gibson Boulevard to the Rio Bravo East Extension Corridor	High degree of access control

Tramway Boulevard (NM 556)

K. Tramway Boulevard (R-82-3, R-82-10, R-84-19, R-86-13)	
A general policy of limiting full access to approximately one-half mile spacing with the specific access controls listed below.	
1. I-40 to Montgomery Boulevard	As currently (July 1986) constructed
2. Montgomery to the Sandia Indian Reservation	a. Montgomery Boulevard (full intersection)
	b. Vicinity of southern boundary of Elena Gallegos Grant (T-intersections east and west with no median opening)
	c. Manitoba Street (full intersection)
	d. Spain Road (full intersection)
	e. Academy Road (full intersection)
	f. Simms Park access road (T-intersection east with median opening)
	g. San Rafael Avenue (full intersection)
	h. Tramway Terrace (full intersection)
	i. San Bernardino Avenue (full intersection)
	j. Paseo del Norte (T-intersection west with median opening)
	k. Live Oak Road (full intersection)
	l. Alameda Boulevard/Cedar Hill Road (full intersection)
	m. Tramway Lane (full intersection)

Unser Boulevard

L. Unser Boulevard (R-84-15, R-85-8, R-87-11, R-89-16, R-92-3, R-93-7, R-95-2, R-95-21, R-2000-11, R-2001-9, R-2001-11, R-02-17, R-03-19, R-2001-24, R-03-25, R-04-19, R-04-28, R-05-01, R-05-12, R-06-02 TCC, R-08-01 TCC, R-09-01 TCC, R-09-02 TCC, R-12-01 TCC, R-13-02 TCC, R-13-03 TCC)			
A high capacity, limited access Principal Arterial from Gun Club Road to US 550 with full access at-grade intersections at one-half mile intervals. Right-in, right-out access points may be located at approximately one-quarter mile intervals, provided the access location does not degrade traffic flow and upon review by the TCC and approval by the MTB . This policy will serve as guidance to future corridor or access studies for Unser Boulevard south of Gun Club. Access is provided as listed below.			
1. Rio Bravo Boulevard To Central Avenue	a. Full-access intersections at:	1) Rio Bravo (Senator Dennis Chavez) Boulevard	
		2) Midway between Rio Bravo and Blake Road	
		3) Blake Road	
		4) Gibson Boulevard w/ Spring Flower Road	
		5) Arenal Road/Sapphire Road	
		6) Sage Road	
		7) Tower Road	
		8) Bridge Boulevard	
	b. Partial-access intersections at:	1) Freshwater Road (right-in/right-out access to the east)	
		2) Kimela Drive (right-in/right-out access to the west)	
		3) West side of Unser approximately 800 feet south of Sage Road right-in/right-out/left-in R-08-01 TCC	
		4) Right-in on east side of Unser approximately 500 feet south of Sage Road. R-10-04 TCC	
		5) Midpoint between Sage Road and San Ygnacio Road (right-in/right-out) R-09-02 TCC	
		6) San Ygnacio Road (right-in/right-out access to the east and west); (Southbound Unser to Eastbound San Ygnacio left turn) R-09-02 TCC	
		7) 475 feet north of the centerline of Tower Road (right-in/right-out access to the east)	
		8) Eucariz Avenue (right-in/right-out access to the east and west)	
		9) Sunset Gardens Road (right-in/right-out access to the west)	
		10) Gwin Road (right-in/right-out access to the east)	
		11) Frederick Lane (right-in/right-out access to the east)	

Unser Boulevard continued			
2. Central Avenue to Ouray Road	a. Full access intersections at:	1) Central Avenue	
		2) Bluewater Road	
		3) Los Volcanes Road	
		4) Interstate 40 (grade-separated full interchange)	
		5) Ladera Drive	
		6) 98th Street (a.k.a. Tierra Pinta Blvd.) & Vista Orienta Street	
	b. Partial access intersections at approximately one-quarter mile intervals shall be provided at the following specified locations:	1) Central Avenue to Bluewater Road - Access to the east at Sarracino Place until the adjacent properties redevelop or when the ultimate roadway is constructed. Permanent access will be reevaluated at that time through a traffic study.	
		2) Saul Bell Road - Left-turn bay from Unser Blvd northbound to Saul Bell Road westbound. R-12-01 TCC	
		3) Bluewater to Los Volcanes Road - east side of Unser approximately 700 feet north of Bluewater (right-in/right-out access)	
		4) La Miranda Plance - Access to the east at "La Mirada" (right-in and right-out)	
5) Old Ouray Road - Access to the east at "Old Ouray Road", approx. 950 ft south of Ouray Road (New) and Unser Boulevard (right-in and right-out)			
6) Unser approximately 475 feet north of centerline of 98th Street - right-in R-04-19 MTB			
7) 950 feet south of Ouray (right-in right-out, on the east side) [now called Brawley Rd]			
3. Ouray Road and Dellyne Avenue	a. Full access, at-grade intersections	1) Ouray Road & Lava Bluff Drive	
		2) St. Joseph's Avenue	
		3) Western Trail & Petroglyph Park Road	
	b. Partial access intersections at approximately quarter mile intervals	1) Ouray Road to St. Joseph's	a) West at St. Joseph's Loop (right-in and right-out)
			b) East at Vista Allegre Street (right-in/right-out)
		2) St. Joseph's Avenue to Western Trail	a) West at Lava Shadows Loop (right-in/right-out)
			b) East - location to be coordinated with property owners (right-in/right-out) [now called Boca Negra Pl.]
		3) Western Trail to Dellyne Avenue	a) West at Vulcan Parkway (right-in/right-out with a directional north-to-west left turn only)
			b) East between the proposed Atrisco Drive cul-de-sac and the San Antonio Arroyo - location to be coordinated with property owners (right-in/right-out) [now called Sipapu Ave]
			c) East between the San Antonio Arroyo and Dellyne Avenue (right-in/right-out) [now called Azuelo Ave]

Unser Boulevard continued		
4. Dellyne Avenue to Paradise Boulevard	a. limited to full access at-grade intersections at the specified locations:	1) Dellyne Avenue & Astair Avenue R-13-03 TCC
		2) Montaña Road
		3) Atrisco Road (T-intersection to the east) (With the new alignment of Unser, this street takes the place of formerly approved T-intersection for Santo Domingo St.)
		4) 81st Street (T-intersection to the west)
		4) Molten Rock Rd R-13-03 TCC
		5) Rainbow Blvd (formerly listed as Compass Drive)
		6) Kimmick Drive (unsignalized T-intersection to be converted to right-in/right-out once the intersection would require a traffic signal.) R-13-03 TCC
		7) Rosa Parks Avenue (formerly listed as Squaw Rd)
		8) A new street approx. 1,027 feet south of Paseo del Norte and 2,791 feet north of Rosa Parks Ave. R-13-03 TCC
		9) Paseo del Norte (at-grade intersection until grade-separation is needed) R-13-03 TCC
		9a) A temporary access approx. 400 feet north of Paseo del Norte R-13-02 TCC
		10) A point approximately halfway between Paseo del Norte and Lilienthal-Blue Feather/Boulder Trail approx. 2,389 feet north of Paseo del Norte which corresponds to the location of the "Transit Blvd" proposed in the Volcano Heights Sector Plan.
11) Blue Feather/Boulder Trail (With the new alignment of Unser, this street takes the place of the formerly approved full-intersection for Lilienthal Ave.)		
12) Paradise Boulevard		
b. Partial access intersections shall be provided at the specified locations:	1) Flor del Sol Place (unsignalized T-intersection to be converted to right-in/right-out once the intersection would require a traffic signal.) R-13-03 TCC	
	2) Bogart Street (unsignalized T-intersection to be converted to right-in/right-out once the intersection would require a traffic signal.) R-13-03 TCC	
	3) Kimmick Drive (unsignalized T-intersection to be converted to right-in/right-out once the intersection would require a traffic signal.) R-13-03 TCC	
	4) A new street approx. 1,105 feet north of Paseo del Norte (right-in/right-out on east side of Unser Blvd. and a right-in/right-out on west side of Unser Blvd. No median break for either side.) R-13-03 TCC	
	4) A new street approx. 1,160 feet south of Blue Feather/Boulder Trail (right-in/right-out on east side of Unser Blvd. and a right-in/right-out on west side of Unser Blvd. No median break for either side.) R-13-03 TCC	
	4) Buglo Avenue (right in/right out/left in) R-07-02 TCC	
Access Prohibition	Access Prohibition: Unser Boulevard within the Volcano Heights Sector Plan area shall have access restricted to the dedicated streets granted access above with no additional driveways or vehicular access locations permitted. All access to businesses, residences, etc. shall only be from the local and collector streets to be built in the development(s). R-13-03 TCC	

Unser Boulevard continued		
5. Paradise Boulevard to Southern Boulevard	a. Access shall be limited to full access at-grade intersections at the specified locations:	1) Cabezon Boulevard
		2) Westside Boulevard
		3) Wellspring Ave/Rhonda Ave R-09-03 TCC
		4) Arroyo Road (Healthy Way); signalized "T" Intersection (City of Rio Rancho correspondence on June 20, 2008 - three-party agreement with City of Albuquerque and NMDOT) Full Inter under R-09-03 TCC
		5) Night Whisper Road (approximately 1,200 feet north of McMahon)
		6) McMahon Boulevard
		7) Arenal Road/Sapphire Road
		8) Bandelier Drive
		9) Irving Boulevard
		10) Paradise Boulevard
		11) Exception: The Bernalillo County Volunteer Fire Department No. 7, located immediately north of Paradise Boulevard, shall be provided with access to Unser Boulevard, including a median opening for the express purpose of serving this fire station. The median opening and driveway access to the station will be closed when Fire Department No. 7 is relocated.
		12) Commercial Drive (right in/ right out/ left in) R-05-12 MTB
	b. Partial accesses allowing only for left turns from Unser Boulevard and right-in/right-outs from the adjacent parcels shall be allowed at:	1) 700 feet north of McMahon
		2) 700 feet south of McMahon
		3) 700 feet north of McMahon (access point changed to 450 feet north of McMahon) R-04-28 MTB
c. Right-in/right-out access shall be allowed at:	1) <i>Right-in only</i> approximately the midpoint between Westside Boulevard and Arroyo Road R-09-01 TCC	
	2) Approximately half-way between Black Arroyo Boulevard and Arroyo Road (Healthy Way), <i>right-in only</i> (City of Rio Rancho correspondence on June 20, 2008 - three-party agreement with City of Albuquerque and NMDOT)	
	3) Black Arroyo Boulevard (in each direction)	
	4) Approximately 520 feet north of the Cabezon Blvd/Southern Blvd intersection R-06-02 TCC	
	5) A right-in only access on the west side of Unser Blvd. approximately 650 feet south of Westside Boulevard. R-09-03 TCC	
d. Until traffic safety and capacity considerations warrant their closure, local access shall be allowed at:	1) Essex Drive (right-in/right-out access to the west, and left-in access)	
	2) Fordham Drive (right-in/right-out access to the east)	
	3) Alder Drive (right-in/right out access to the west)	
6. Southern Boulevard to US 550	a. It is strongly encouraged that this access control policy be applied to Unser between Southern and US550 to assure that the function and capacity of the roadway are protected in the future.	
	b. Full-access intersections at:	1) Zaragosa Rd R-05-01 MTB

Uptown Loop Road

M. Uptown Loop Road

Access shall be as defined in the Uptown Sector Plan.

Westside Boulevard

N. Westside Boulevard (R-2000-11)

Access shall be provided for full intersections at approximate one-half mile intervals and for T intersections and right-in/right-out driveways at approximate one-quarter mile intervals, except within the potential village center area of Unit 16. Here more frequent access is allowed provided that driveways are not located closer than approximately 400 feet from adjacent access points.

	Full Intersection at:	1) Approximately 1,200 feet west of Unser Boulevard. R-09-03 TCC
	Partial Access at:	1) A right-in/right-out & left-in access on the south side of Westside Blvd approximately 700 feet west of Unser Boulevard. R-09-03 TCC



MEMORANDUM

To: Mikaela Renz-Whitmore, City of Albuquerque Planning Department
From: Colin Burgett, Magnus Barber, Rick Chellman and Jeremy Nelson
Date: August 7, 2012
Subject: Volcano Heights Multi-modal Transportation Assessment

This memorandum describes the traffic forecast and circulation assessment conducted by Nelson\Nygaard of the proposed roadway network described in the Working Draft of the *Volcano Heights Sector Development Plan* (VHSDP) as of April 2012.

Purpose of the Sector Plan

The purpose of the VHSDP is to leverage the opportunity to create a major employment and activity center on the City's West Side in order to address the imbalance of jobs on the East Side and primarily housing on the West Side and relieve some congestion on river crossings caused by one-way commutes over time.

The Plan proposes a high-density, mixed-use development pattern that can encourage pedestrian, bicycle, and transit use for local trips without adversely impacting auto travel on the region's most important arterials – Paseo del Norte and Unser Boulevard, both of which are access-controlled by policy. This proposal has elicited several concerns by stakeholders and agency staff, including:

- Local impact of such intense development on surrounding neighborhoods and roadways;
- Regional impact of this development on the broader transportation network; and
- Potential effect of additional intersections on limited-access roadways.

Purpose of this Report

In order to assess the key concerns summarized above, Nelson\Nygaard was engaged by the Sector Plan consultant, Gateway Planning Group, as traffic engineering consultants to perform this traffic study.

The purpose of this assessment is to provide a conceptual, high-level analysis of the proposed roadway network. The analysis included conservative assumptions on various inputs in order to generate the worst-case scenario as a baseline for comparison between currently forecasted traffic volumes for 2035 and potential changes based on the proposed Plan.

- This study is not meant to provide the level of precision of a “near-term” Traffic Impact Analysis typically required to justify an access modification request for pending development applications on these limited-access roads.
- This report provides an “order-of-magnitude” trip generation comparison to assess the local impact of such intense development on surrounding neighborhoods and roadways.

- The circulation assessment focuses on potential operational concepts related to proposed quarter-mile spacing of intersections on the access-controlled Paseo del Norte and Unser Boulevard corridors within the Sector Plan boundary.

Report Overview

The traffic assessment is divided into the following three parts:

1. Traffic Forecast

Nelson\Nygaard prepared a forecast of motor vehicle traffic that would be generated by the land uses identified in the VHSDP and assessed the potential effect on the key regional roadways bordering the sector based on forecasted Year 2035 traffic volumes. The following steps were conducted:

- Review of VHSDP development assumptions including:
 - Land use buildout assumptions under the 2012 VHSDP and prior *Volcano Heights Conceptual Plan* prepared in 2006 that was used as the basis for growth assumptions put into the Mid-Region Council of Governments (MRCOG) traffic forecast to generate the 2035 Metropolitan Transportation Plan
 - Relevant VHSDP regulatory assumptions related to the planned design and long-term operation of the two key regional roadways that will provide access to the sector: Paseo Del Norte and Unser Boulevard
- Review of regional traffic forecast information relevant to site access focusing on:
 - Forecasted future traffic volumes on regional roadways that will serve the site, based on the MRCOG regional travel demand model forecast of Year 2035 traffic volumes
 - Confirmation of land use development assumptions for the Volcano Heights “sector” contained in the MRCOG Year 2035 traffic forecast, for purposes of assessing the potential change to Year 2035 traffic volumes resulting from land uses proposed in the 2012 VHSDP
- Preparation of preliminary Trip Generation forecast
 - Nelson\Nygaard prepared a preliminary forecast of Year 2035 trip generation for planning purposes, based on anticipated Year 2035 land uses under the proposed 2012 VHSDP
 - Nelson\Nygaard also provided a comparative trip generation for the site, based on the assumed Year 2035 land uses that are incorporated into the MRCOG Year 2035 model, for purposes of assessing the “net change” to Year 2035 traffic that would result from the VHSDP

2. Circulation Assessment

Incorporating the trip generation evaluation described in Part 1, Nelson\Nygaard provided input on the proposed street network as described in Part 2 of this report, focusing on review of:

- 2012 VHSDP site access characteristics focusing on proposed:
 - Circulation to and from adjacent sectors outside the boundaries of the VHSDP
 - Multi-modal access to the regional arterial and transit network
 - Site access capacity relative to trip generation forecast
- Proposed VHSDP internal street plan elements related to:
 - Block size and distance(s) between intersections
 - Network connectivity

- Right-of-way widths (streets, sidewalks, and bicycle/pedestrian trails)
- Internal capacity relative to trip generation forecast

3. Relevant Case Studies

Based on the forecasted Year 2035 volumes on the two key regional arterials that will provide access to the sector, Paseo Del Norte and Unser Boulevard, Section 3 describes the general design and operational characteristics of several arterial streets in other cities for comparative purposes. In particular, the case studies provide examples of arterial streets that operate acceptably, carrying similar volumes of traffic as forecasted on Paseo Del Norte and Unser Boulevard, and include desired characteristics identified in the Sector Plan related to:

- Intersection spacing
- Narrower right-of-way configurations
- Multi-modal circulation elements

Figure 1-1. Local Context: Volcano Heights Sector & Adjacent Planning Areas



Source: City of Albuquerque Planning Department, Summary Sheet for *Volcano Heights Sector Development Plan*, March 27, 2012

Figure 1-2. Regional Context: Key Circulation Routes



Source: City of Albuquerque, *Volcano Heights Planning Study Report*, March 15, 2005

1. TRAFFIC ASSESSMENT

This section describes the steps taken to prepare a preliminary forecast of future traffic volumes that would be generated by the proposed land uses described in the VHSDP and an assessment of the resulting effect on the key regional circulation routes the provide access to the site.

VHSDP Development Assumptions

The traffic study did not include a comparison of existing zoning – Residential Developing (RD) Area Zone. RD is intended primarily as a holding zone until an area develops, allowing only single-family and townhouse development without an adopted sector development plan. The existing zoning, if unchanged, would result in exclusively residential development, most likely predominantly single-family houses with some townhouse development along major corridors. This development could result in up to 12,000 dwelling units, which would add another “bedroom community” on Albuquerque’s West Side. The table below is included for informational purposes only to facilitate a high-level comparison.

In general, the amount of traffic generated based on the development scenarios below would be less than either the 2006 Conceptual Plan or the 2012 proposed Sector Plan, but it also would not include any services or employment for the surrounding area, which is a stated City policy for the Volcano Heights area. There would also be no reduction of vehicle trips from mixed-use scenarios or from compact development that can support transit service and encourage transit ridership. As shown on Figure 1-3, development of 2,848 single-family dwelling units, a development scenario that would be allowable under existing zoning, would generate over 26,000 daily vehicle trips (approximately 9.5 daily vehicle trips per dwelling unit) on adjacent roads, and approximately 2,800 vehicle trips during the PM peak hour (approximately one peak hour vehicle trip per unit).

Figure 1-3. Single-family Dwelling Units (DU) and Traffic Generation

Land Use	No. Units	Trip Generation Rate (see note 1)				Total Trips		
		Daily	AM Peak	PM Peak	Units	Daily	AM Peak	PM Peak
Scenario A: Residential Development with 1/2 Acre Lot Sizes (see note 2)								
Detached	924 (units)	9.57	0.77	1.02	/unit	8,843	711	942
Transit Trips (see note 5)		0%	1%	1%		27	7	7
Walk & Bicycle Trips (see note 6)		0%	0%	0%		0	0	0
Total Vehicle Trips Generated						8,821	704	935
Internal Vehicle Trips		0%	0%	0%		0	0	0
External Vehicle Trips (see note 6)		100%	100%	100%		8,821	704	935
Scenario B: Residential Development with 1/4 Acre Lot Sizes (see note 3)								
Detached	1,681 (units)	9.57	0.77	1.02	/unit	16,087	1,294	1,715
Transit Trips (see note 5)		0%	2%	2%		78	26	26
Walk & Bicycle Trips (see note 6)		0%	0%	0%		0	0	0
Total Vehicle Trips Generated						16,010	1,268	1,689
Internal Vehicle Trips		0%	0%	0%		0	0	0
External Vehicle Trips (see note 6)		100%	100%	100%		16,010	1,268	1,689
Scenario C: Residential Development with 1/8 Acre Lot Sizes (see note 4)								
Detached	2,848 (units)	9.57	0.77	1.02	/unit	27,255	2,193	2,905
Transit Trips (see note 5)		1%	4%	3%		263	88	88
Walk & Bicycle Trips (see note 6)		3%	2%	1%		818	33	29
Total Vehicle Trips Generated						26,175	2,072	2,788
Internal Vehicle Trips		0%	0%	0%		0	0	0
External Vehicle Trips (see note 6)		100%	100%	100%		26,175	2,072	2,788

Year 2035 Land Uses with Sector Plan

Unlike the existing zoning, the land use strategy in the 2012 VHSDP allows mixed-use development, with residences and services within walking or biking distance of each other. This development is intended to serve new residents, nearby residents, as well as regional markets. VHSDP development assumptions for Year 2035 were based on the allowable land uses, as described in the VHSDP, and a market assessment of future demand for office and retail space in the area within the specified timeframe. Based on that assessment, City Planning staff provided the following forecast of Year 2035 land uses:

- 2 million square feet of commercial space including:
 - 1.2 million square feet of office space
 - 800,000 square feet of retail space (mix of regional-serving, local-serving and specialty retail uses)
- 4,769 residential dwelling units consisting of:
 - 4,114 multi-family dwellings
 - 364 single-family detached dwellings
 - 291 single-family attached (rowhouse, townhouse, or duplex) dwellings

Figure 1-4 shows the proposed land use designations described in the VHSDP. Based on the distribution of allowable land uses within the sector, Gateway Planning provided a detailed spreadsheet describing the potential allocation of development on a block-by-block basis. Figure 1-5 shows a sketch version of the block layout utilized for conceptual forecasting purposes only.

Planned Arterial Street Network

The planned regional roadway network includes three key facilities that will provide direct access to Volcano Heights:

- Paseo del Norte, designated as a 6-lane limited-access facility with half-mile spacing between signalized intersections, including grade-separated crossings at several locations outside the sector and at-grade intersections planned within the study area,
- Unser Boulevard, designated as a 4-lane limited-access facility with half-mile spacing between signalized intersections and at-grade intersections planned within the study area, and
- Universe Boulevard, designated as a 4-lane major arterial.

Figure 1-4. VHS DP Proposed Character Zones & Street Types

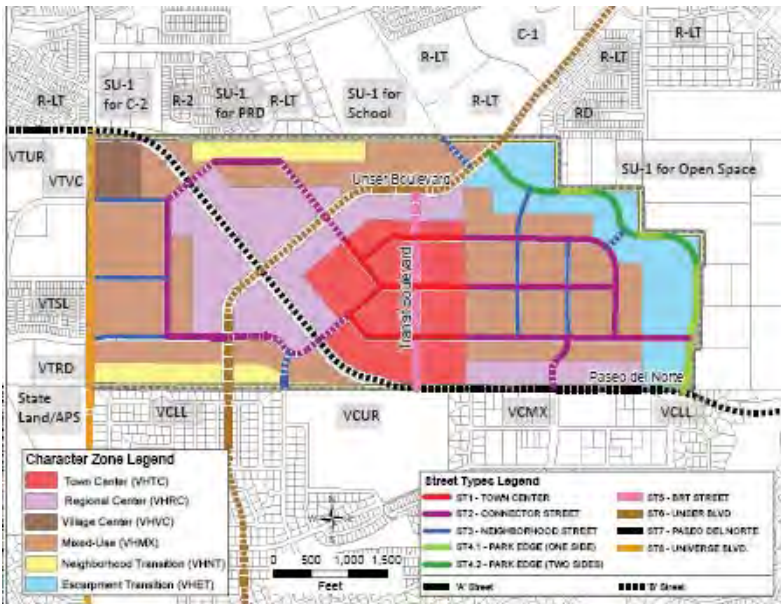

Source: City of Albuquerque Planning Department, Summary Sheet for *Volcano Heights Sector Development Plan*, March 27, 2012

Figure 1-5. Conceptual Illustration of Possible Internal Streets & Block Layout

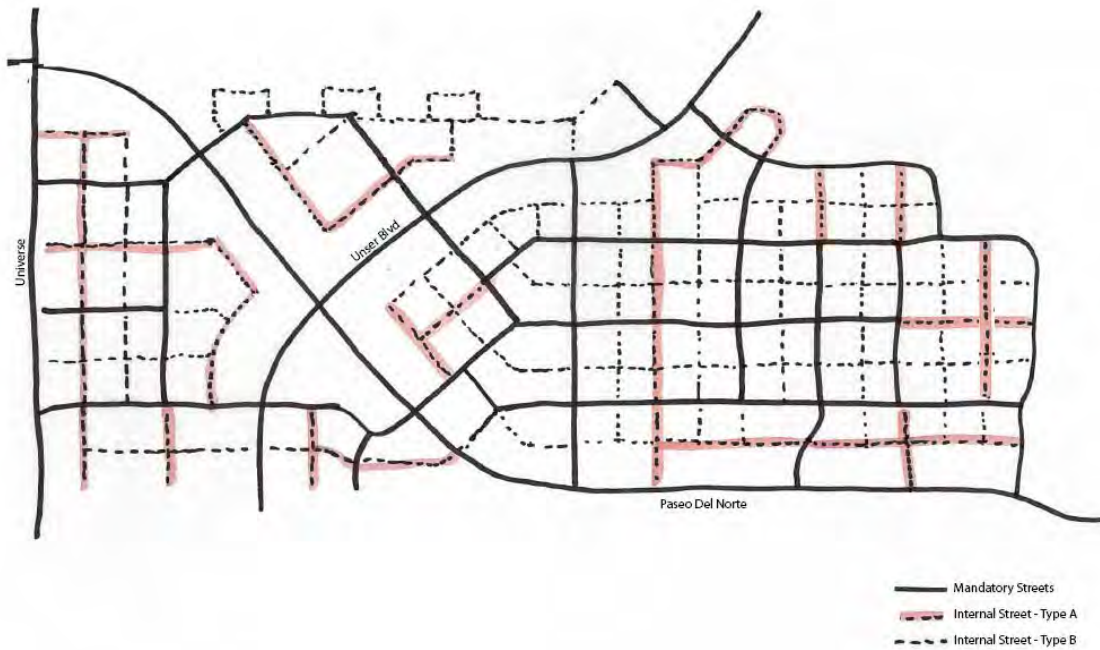

Source: Gateway Planning, Draft *Volcano Heights Internal Streets*, April 30, 2012 (For traffic modeling purposes only)

Regional Travel Model Assumptions

Future traffic volumes on the regional roadway network are forecasted by the MRCOG regional travel demand model.

Figure 1-6. Regional Travel Model Network & Conceptual VH Road Network

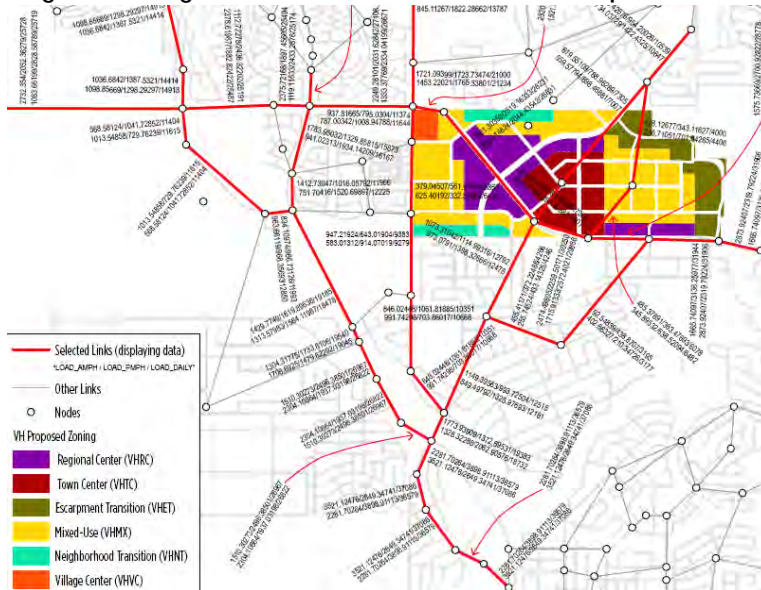

Year 2035 Land Uses without Sector Plan (Baseline Development Scenario)

The MRCOG model forecast of Year 2035 traffic volumes generated by development of the Volcano Heights sector is based on the proposed mix of land uses identified in the 2006 Volcano Heights Conceptual Plan. The anticipated level of development by Year 2035 would consist of 1,650 dwelling units and commercial development providing 9,500 jobs, representing approximately 3 million square feet of commercial development.

The Conceptual Plan envisioned a similar “village” core as the Sector Plan, but with several key differences:

- Outside of the “village” core area, the Conceptual Plan designated most of the site for office development, with a much smaller area designated for potential residential development.
 - The Conceptual Plan would allow over 1 million square feet of additional office space, compared to the Sector Plan, primarily with “office park” developments outside of the “village” core
- As a result, the number of residential units allowed under the Conceptual Plan is much lower than the Sector Plan
 - Under the Conceptual Plan, just 1,650 residential dwelling units are anticipated by Year 2035

- Under the proposed Sector Plan, up to 4,800 residential dwelling units are anticipated by Year 2035
- Both plans would allow similar levels of retail development within the “village core” area. Therefore, since the Sector Plan forecast of Year 2035 commercial development is based on anticipated retail demand in the area, there is no difference anticipated in the mix of retail uses under Year 2035 conditions
- A key difference between the two plans is the proposed street layout, identified in the Sector Plan, which would extend the “village” grid concept to cover most of the VH sector, with smaller block sizes, narrower streets, and an increased emphasis on facilitating local connections at multiple intersections, with dispersal of traffic throughout the grid network. The mix of uses in close proximity is also intended to facilitate additional pedestrian and bicycle trips and help support transit service and encourage transit use.

Figure 1-7 shows the forecasted Year 2035 daily traffic volumes, including vehicle trips generated by VH Conceptual Plan land uses, on the regional roads providing access to the area. Peak hour traffic volumes are forecasted to be roughly 10 percent of daily traffic volumes.

Figure 1-7. Forecasted Year 2035 Traffic Volumes (with Baseline Land Uses from VH Conceptual Plan)



Source: Mid-Region Council of Governments, Year 2035 Daily Traffic Volume Forecast

As shown on Figure 1-7, forecasted daily volumes on the key regional roadways providing access to the Volcano Heights sector are as follows:

- East/West Circulation
 - Paseo del Norte: 60,000 daily vehicles within the VH core area
- North/South Circulation
 - Unser Boulevard: 14,000 daily vehicles within the VH core area
 - Universe Boulevard: 13,000 daily vehicles bordering the VH sector
 - Rainbow Boulevard, west of the VH sector: 50,000 daily vehicles by-passing the VH sector
 - South of the study area, north/south circulation will be funneled onto just one north/south connection to be provided by the lower segment of Unser Boulevard, projected to carry over 70,000 daily vehicles

Future Traffic Capacity

Planned roadway capacity and forecasted Year 2035 traffic volumes are summarized below in Figure 1-8. As shown, a significant amount of excess north-south capacity will be provided on both Unser and Universe Boulevards, while Paseo del Norte will operate at full capacity.

Figure 1-8 Future Traffic Volumes & Planned Capacity on Major Arterials within Volcano Heights

Planned Year 2035 Roadway Network Capacity & Forecasted Traffic Volumes								
Regional Road	Through Lanes (Planned)		Intersection Turn Lanes (Planned)		Approximate Capacity* (Planned)		2035 Traffic Volume Forecast ***	
	Total Lanes	Lanes per Direction	Left-turn lanes at signalized intersections	# of right-turn lanes at intersections	Peak Hour	Daily **	Daily	# of Through Lanes Needed to Accommodate Forecasted Volume
Paseo del Norte	6	3	2	1	6,000	60,000	60,116	6
Unser Blvd	4	2	2	1	4,000	40,000	14,312	2
Universe Blvd	4	2	1-2	0-1	3,500	35,000	13,524	2

*Assumes a balanced signal timing plan, with equal allocation of time to all approaches at major intersections.
 **Daily capacity is typically estimated based on peak-hour capacity multiplied by ten.
 ***Forecasted traffic volume within the Volcano Heights core area based on Conceptual Plan land uses and street network.

Implications for Volcano Heights Roadway Network

Excess capacity on Unser and Universe Boulevards provides an opportunity to potentially consider narrower right-of-way allocations on those two facilities within and bordering the VH site. Given the grid street pattern, and potential traffic constraints on Paseo del Norte, it seems likely that future VH residents will generally prefer Unser and/or Universe for local access, especially during peak travel periods. (Also see Section 3 of this report that provides several examples of street configurations from other cities carrying similar traffic volumes).

Spacing of Signalized Intersections

A key factor relevant to the proposed internal VH circulation network relates to the desired spacing of signalized intersections on major arterials, particularly on Paseo del Norte. In walkable, mixed-use areas, typical block sizes of 300 to 400 feet allow for direct pedestrian travel between destinations. Where half-mile (2,620 feet) or quarter-mile (1,320 feet) distances are provided on major arterials, walking distances of over a half-mile can be required between land uses on opposite sides of the same street.

However, where traffic volumes are high relative to capacity, as will be the case on Paseo del Norte, it will be difficult to achieve 2-way synchronization of traffic signals at the desired regional travel speeds of 40 to 50 miles per hour (mph). Figure 1-9 provides examples of 2-way signal coordination options with varying travel speeds and varying distances between signalized intersections (half-mile, quarter-mile, and smaller).

Figure 1-9 Travel Speed & Intersection Spacing Considerations on Major Arterials

General Distance between Signalized Intersections for 2-way Signal Synchronization at Various Travel Speeds					
Travel Speed (mph)	2-way synchronization options				Notes
	Distance between signalized intersections	Signal off-set for 2-way coordination (seconds)	Signal cycle length (seconds)*	Travel Time on Paseo del Norte through VH	
50	Half-mile	36	72	2.1	<i>Cycle lengths of less than 90 seconds likely infeasible at higher speeds with wide right-of-way & turn phases.</i>
45	Half-mile	40	80	2.3	
40	Half-mile	45	90	2.6	<i>Cycle length of 90 to 120 seconds likely required on Paseo del Norte to accommodate 120-ft pedestrian crossing distances and left-turn phases.</i>
36	Half-mile	50	100	2.9	
30	Half-mile	60	120	3.5	
30	Quarter-mile	30	60	3.5	<i>Cycle length of 60 to 90 seconds may be feasible with reduced travel speeds and shorter pedestrian crossing distances.</i>
25	Quarter-mile	36	72	4.2	
20	Quarter-mile	45	90	5.2	
18	660 ft	25	50	5.8	
15	660 ft	30	60	7.0	
10	400 ft	30	60	10.5	<i>Ideal travel speed for bicycle circulation.</i>

*Assumes a balanced signal timing plan, with equal allocation of time to all approaches at major intersections.
 ** Length of Paseo del Norte = 1.75 miles through Volcano Heights sector.

Sector Plan Traffic Generation

The steps undertaken to provide a preliminary vehicle trip forecast for proposed Year 2035 land uses under the VHSDP are described below.

Step 1: ITE Baseline Trip Generation

The baseline forecast of trips that would be generated by the Year 2035 land uses within the VHSDP boundaries was derived using trip generation rates for the key land use types provided by the Institute of Transportation Engineers (ITE) *Trip Generation Manual*, 8th edition.

ITE trip generation rates are based on studies of suburban locations, typically “single-use” developments. Such developments typically are located in areas with minimal public transit service and minimal provisions for pedestrian and bicycle circulation. Land uses selected for observation also generally provide separate, free parking facilities for each land use, and nearly all trips to and from such sites are made via private motor vehicle.

ITE chose to collect data at single-use suburban sites precisely to provide a “baseline” forecast of traffic generation that should be adjusted based on local characteristics and site-specific factors, such as:

- Rates of transit ridership and service
- Provisions for pedestrian and bicycle circulation
- Density and mix of land uses, particularly relevant to mixed-use developments, as envisioned in the VHSDP, in which a portion of trips will occur internally, between the various land uses within the sector

Since the baseline trip generation rates for individual land uses are based on data collected at low density development with separated land uses and minimal transit, walking, or biking, ITE cautions that trip generation analysis using ITE rates as a “baseline” must take into account land use and transportation alternatives from the local context in order to be accurate.

The methodology for applying site-specific trip generation factors based on the proposed mix of land uses and proposed street network configuration is described in Steps 2, 3, and 4.

Step 2: Baseline Trip Adjustment to Avoid Double-counting of Internal Trips

The model was adjusted to account for internal trips to/from retail uses that would otherwise be double-counted, based on ITE internal trip capture data for retail uses (to/from office, residential and other retail uses) in mixed-use developments.

Step 3: Baseline Trip Adjustment to Account for Retail Pass-by Trips

A significant portion of retail trips are “pass-by” trips (e.g. stopping at a store on your way home). In this example, the store itself did not generate the trip but rather benefits from its location on your route home. Pass-by trip rates are often between 20 and 50 percent of retail trips, generally higher for smaller retail establishments.

This forecast applied a PM Peak Hour pass-by rate of 25 percent for PM Peak derived from ITE logarithm for Shopping Centers applied to the anticipated size of regional retail sites within VH (determined at the block level). The daily pass-by rate was estimated conservatively at 15 percent.

Step 4: Bicycle & Walking Trips

The proposed development will have a relatively dense street network, a mix of land uses in close proximity, and street designs that incorporate facilities for bicycle, pedestrian and transit users. Residents and employees living and working in Volcano Heights will have some transportation choice; different modes may be more convenient at different times, depending on the trip.

Since the ITE average trip generation rates are based on observations made at single-use sites, the ITE average rates will not accurately predict the level of trip generation that would result from the proposed mix of uses at Volcano Heights. Therefore, consistent with the ITE recommended practice, the ITE average rates were adjusted based on local conditions, including the proposed mix of land use types.

To estimate the effect of the proposed mix-use development pattern on trip generation, Nelson\Nygaard used the URBEMIS methodology. URBEMIS is a program developed for the California Air Resources Board to calculate vehicle trips and resulting emissions resulting from new development.

URBEMIS was developed to more accurately reflect the level of vehicle trip generation resulting from new development by providing formulas based on specific site characteristics. The URBEMIS methodology is designed to offer a useful comparison of the difference in trip generation that can be expected when locating high density development in mixed-use, high-density areas with alternative transportation modes available and/or transportation demand management programs in place.

URBEMIS calculates trip generation rates starting with the ITE average trip generation rates as a base. The URBEMIS method employs standard methodologies but provides the opportunity to adjust ITE average rates to quantify the impact of a development's location, physical characteristics, and any demand management programs. In this way, it provides an opportunity to fairly evaluate developments that minimize their transportation impact, for example, through locating close to transit or providing high densities and a mix of uses.

Area Inputs

In addition to requiring the transportation modeler to input the basic land use components of the proposed project (i.e. the number of square feet of each land use), URBEMIS also factors in other area-specific characteristics to determine accurate trip rates. The number of trips generated by a development depends not only on the characteristics of the project itself, but also on the nature of the surrounding area. For example, neighborhood characteristics such as a good balance of housing and jobs, the presence of frequent transit service, and a highly-connected, walkable street network are strongly associated with lower vehicle trip rates. High-density housing added to an existing central city neighborhood, where many shops, services, and transit already exist, will normally generate fewer trips than the same housing located close to a freeway interchange and surrounded by only low-density housing subdivisions. For this reason, URBEMIS requires data about the area within approximately a half-mile radius from the center of the project, or for the entire project area, whichever is larger. Figure 1-10 shows the key project area characteristics applicable to the URBEMIS methodology.

Figure 1-10 Area Characteristics Input to URBEMIS Model

Factors
Number of housing units within ½ mile radius
Number of jobs located within ½ mile radius
Local serving retail within ½ mile radius
Transit service
Intersection density within ½ mile radius*
Sidewalk completeness within ½ mile radius
Bike lane completeness within ½ mile radius

Note: * Calculated from proposed street network, based on the number line segment terminations, or each "valence." Intersections have a valence of 3 or higher: a valence of 3 is a "T" intersection, 4 is a four-way intersection, etc.

It is important to note that the above characteristics do not incorporate any transportation demand management (TDM) measures, such as specific programs, incentives, or strategies to reduce trip generation. Rather, they are based entirely on the mix and density of land uses and the proposed design of the road network.

Step 5: Transit Trip Forecast

For planning purposes, a preliminary "back-of-the-envelope" estimate of potential transit ridership was incorporated into this forecast, which assumed a relatively modest level of transit ridership, 5% of home to work trips for both residential and non-residential land uses, plus daily "non-work" transit trips estimated at 50% of daily work trips by transit. Higher levels of transit ridership are ultimately feasible depending on the ultimate level of transit service and transit incentives.

Step 6: Vehicle Trip Forecast

The resulting vehicle trip forecast is shown on Figure 1-11 for Volcano Heights, while a comparative trip generation forecast based on Conceptual Plan land uses, based on the same methodology, is shown on Figure 1-12.

Volcano Heights Multi-modal Transportation Assessment
City of Albuquerque Planning Department – August 7, 2012

Figure 1-11 Preliminary Trip Generation Forecast: Volcano Heights Sector Development Plan (Year 2035)

Land Use	No. Units	Trip Generation Rate (see note 1)				Total Trips		
		Daily	AM Peak	PM Peak	Units	Daily	AM Peak	PM Peak
Residential								
Detached	364 (units)	9.57	0.77	1.02	/unit	3,483	280	504
Attached	291 (units)	5.81	0.44	0.52	/unit	1,691	128	151
Multifamily	4,114 (units)	6.65	0.51	0.62	/unit	27,360	2,098	2,551
Hotel	53,600 (ft2)	8.92	0.64	0.74	/occupied room	797	57	66
Office	1,180,135 (ft2)	11.01	1.55	1.49	/1,000 ft2	12,993	1,829	1,758
Retail								
Regional Retail	326,700 (ft2)	42.94	1.95	7.70	/1,000 ft2	14,028	638	2,515
Specialty Retail	322,198 (ft2)	44.32	6.84	5.02	/1,000 ft2	14,280	2,204	1,617
Local Retail	170,600 (ft2)	42.94	3.72	12.92	/1,000 ft2	7,326	635	2,205
<i>Internal Trip Adjustment (see note 2)</i>		-19%	-15%	-20%		-15,679	-1,181	-2,218
<i>Retail Pass-by Trips (see note 3)</i>		-15%	-15%	-25%		-5,345	-522	-1,584
Base Trip Subtotal (VH Sector Development Plan)						60,935	6,168	7,565
<i>Walk & Bicycle Trips (see note 4)</i>		15%	14%	20%		9,070	836	1,550
<i>Transit Trips (see note 5)</i>		3%	5%	4%		2,000	300	300
Total Vehicle Trips Generated						49,865	5,032	5,715
<i>Internal Vehicle Trips (see note 6)</i>		13%	7%	11%		6,509	330	653
<i>External Vehicle Trips (see note 7)</i>		87%	93%	89%		43,356	4,702	5,062
Notes:								
(1) Base trip rates from ITE Trip Generation, 8th Edition. Peak hour trips rates shown for Regional Retail and Local Retail based on fitted curve logarithm applied at block level.								
(2) Adjustment to account for internal trips to/from retail uses that would otherwise be double-counted, based on ITE internal trip capture data for retail uses (to/from office, residential and other retail uses) in mixed-use developments.								
(3) Pass-by rate of 25 percent for PM Peak derived from ITE logarithm for Shopping Centers (while local and specialty retail uses often have higher pass-by rates). Daily pass-by rate conservatively estimated at 15 percent.								
(4) Mode shift for internal trips based on proposed density, mix of uses, block layout, bicycle and pedestrian facilities								
(5) Based on preliminary "back-of-the-envelope" estimate of potential transit ridership. Assumed 5% of home to work trips for both residential and non-residential land uses would occur via transit plus estimated "non-work" transit trips at 50% of								
(6) Total Vehicle Trips derived by subtracting walk & bicycle trips (see note 4) and transit trips (see note 5) from Base Trip Subtotal.								
(7) Derived from estimated internal trips (see note 2), subtracting internal walk & bicycle trips (see note 4) and internal transit trips (estimated at 5% of transit ridership).								
(8) Net vehicle trips derived by subtracting internal vehicle trips (see note 6) from total vehicle trips generated.								

Volcano Heights Multi-modal Transportation Assessment
City of Albuquerque Planning Department – August 7, 2012

Figure 1-12 Baseline Trip Generation Forecast: Volcano Heights *Conceptual Plan* Land Uses (Year 2035)

Land Use	No. Units	Trip Generation Rate (see note 1)				Total Trips		
		Daily	AM Peak	PM Peak	Units	Daily	AM Peak	PM Peak
Residential								
Detached	490 (units)	9.57	0.77	1.02	/unit	4,689	377	500
Attached	0 (units)	5.81	0.44	0.52	/unit	0	0	0
Multifamily	1,160 (units)	6.65	0.51	0.62	/unit	7,714	592	719
Office Park	1,900,000 (ft2)	11.42	1.72	1.50	/occupied room	21,698	3,268	2,850
Office (Town	280,502 (ft2)	11.01	1.55	1.49	/1,000 ft2	3,088	435	418
Retail (Town								
Regional Retail	326,700 (ft2)	42.94	1.95	7.70	/1,000 ft2	14,028	638	2,515
Specialty Retail	322,198 (ft2)	44.32	6.84	5.02	/1,000 ft2	14,280	2,204	1,617
Local Retail	170,600 (ft2)	42.94	3.72	12.92	/1,000 ft2	7,326	635	2,205
<i>Internal Trip Adjustment (see note</i>		-22%	-15%	-19%		-15,679	-771	-2,010
<i>Retail Pass-by Trips (see note 3)</i>		-15%	-15%	-25%		-5,345	-522	-1,584
Base Trip Subtotal (2006 VH Conceptual Plan Land Uses)						51,800	6,856	7,230
<i>Walk & Bicycle Trips (see note 4)</i>		8%	9%	9%		4,271	592	652
<i>Transit Trips (see note 5)</i>		3%	3%	3%		1,500	225	225
Total Vehicle Trips Generated						46,028	6,039	6,353
<i>Internal Vehicle Trips (see note 6)</i>		25%	3%	21%		11,333	168	1,347
<i>External Vehicle Trips (see note 7)</i>		75%	97%	79%		34,696	5,871	5,007
Notes:								
(1) Base trip rates from ITE Trip Generation, 8th Edition. Peak hour trips rates shown for Regional Retail and Local Retail based on fitted curve logarithm applied at block level.								
(2) Adjustment to account for internal trips to/from retail uses that would otherwise be double-counted, based on ITE internal trip capture data for retail uses (to/from office, residential and other retail uses) in mixed-use developments.								
(3) Pass-by rate of 25 percent for PM Peak derived from ITE logarithm for Shopping Centers (while local and specialty retail uses often have higher pass-by rates). Daily pass-by rate conservatively estimated at 15 percent.								
(4) Mode shift for internal trips based on proposed density, mix of uses, block layout, bicycle and pedestrian facilities								
(5) Based on preliminary "back-of-the-envelope" estimate of potential transit ridership. Assumed 5% of home to work trips for both residential and non-residential land uses would occur via transit plus estimated "non-work" transit trips at 25% of								
(6) Total Vehicle Trips derived by subtracting walk & bicycle trips (see note 4) and transit trips (see note 5) from Base Trip Subtotal.								
(7) Derived from estimated internal trips (see note 2), subtracting internal walk & bicycle trips (see note 4) and internal transit trips (estimated at 5% of transit ridership).								
(8) Net vehicle trips derived by subtracting internal vehicle trips (see note 6) from total vehicle trips generated.								

Findings

Figure 1-13 provides a comparison of the net change in trips resulting from the Sector Plan as shown in Figure 1-11, in comparison with the Baseline scenario represented by the Conceptual Plan trip generation forecast summarized on Figure 1-12. Key findings for traffic operations purposes relate to peak hour traffic volumes. While the development proposed by the Sector Plan does increase external daily vehicle trips, it reduces the A.M. peak hour trips and does not significantly increase P.M. peak hour trips, when traffic congestion is anticipated to be the heaviest. The key findings are summarized as follows:

- No increase in peak hour traffic volumes compared to the baseline scenario,
- Increased bicycle and walking trips and fewer internal vehicle trips compared to the baseline scenario, and
- Adequate traffic grid and street cross sections to accommodate increased internal and external trips compared to the baseline scenario.

Figure 1-13 Daily & Peak Hour Trip Comparison

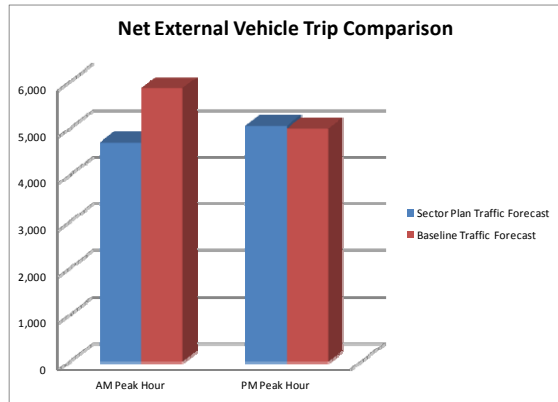
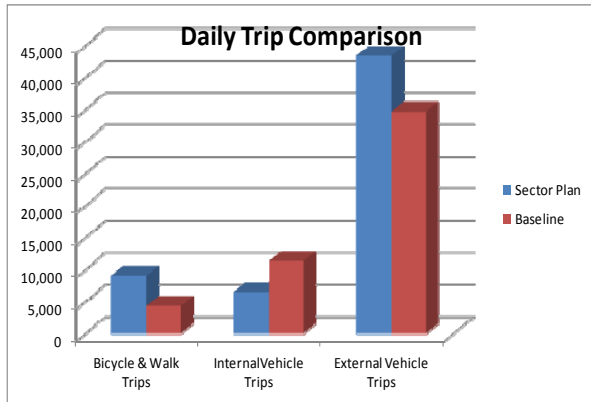

2. CIRCULATION ASSESSMENT

This section provides an assessment of the proposed street network focusing on traffic operations at planned and proposed signalized intersections.

Proposed Site Access

Arterial Access Concept

Figure 2-1 describes the primary access concept described in the 2012 VHSDP. As shown, signalized intersections on Paseo del Norte and Unser Boulevard would be provided at approximately quarter-mile intervals.

Figure 2-1 VHDSP Access Concept

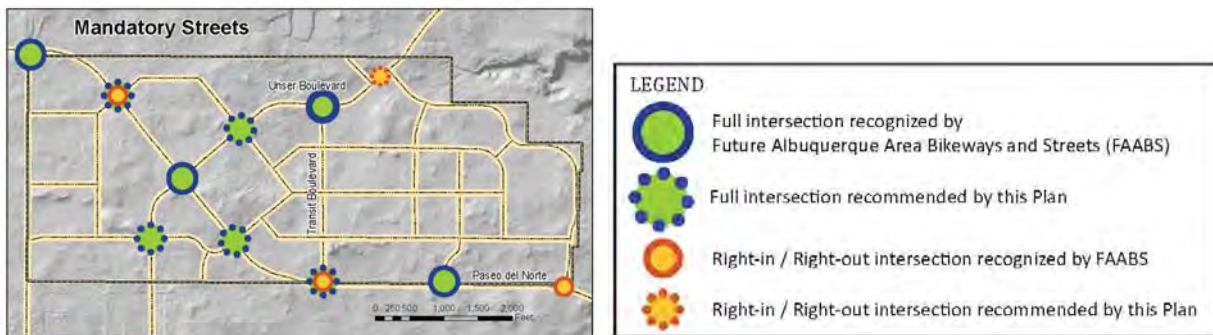

Figures 2-2 and 2-3 provide conceptual cross-section drawings showing the potential lane configurations on Paseo del Norte and Unser Boulevard, as well as potential proximity to adjacent land uses.

Figure 2-2 Paseo del Norte (Conceptual Cross Section)

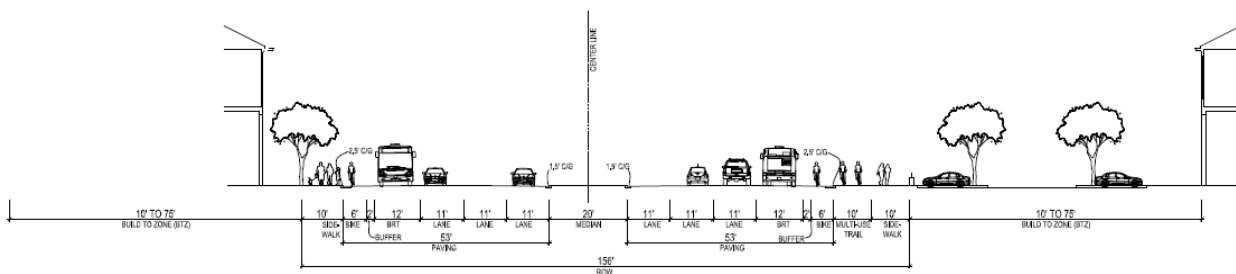
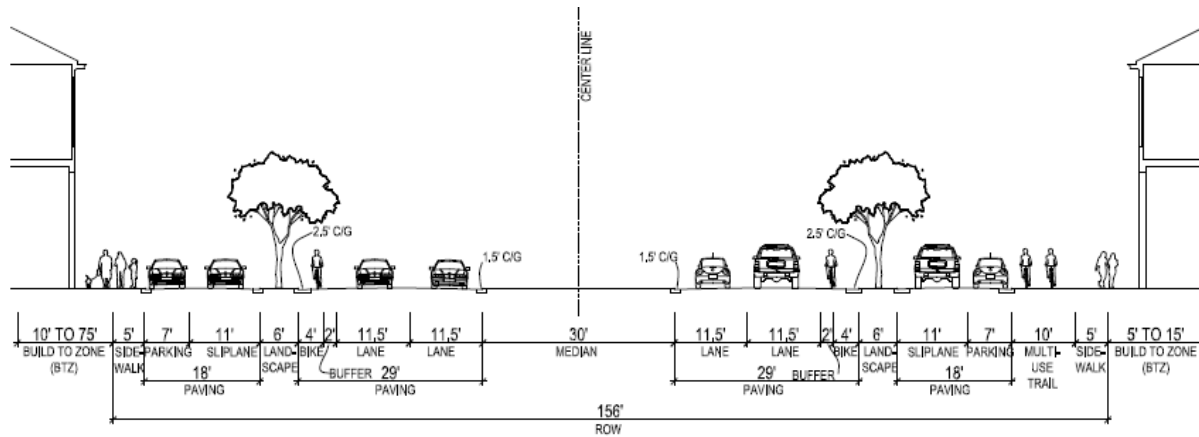

Figure 2-3 Unser Boulevard (Conceptual Cross Section)



Access to Internal Streets & Land Uses

Access to the internal street network and future land uses would primarily be provided by seven internal streets:

- Five internal “connector” streets would circulate between Paseo del Norte and Unser Boulevard, connecting with the internal street grid.
 - The connector streets would intersect the arterials at three proposed signalized intersection locations on Paseo del Norte and two proposed signalized intersection locations on Unser Boulevard.
 - The proposed “connector” streets between Paseo del Norte and Unser Boulevard are designated as NE Connector, NW Connector, SW Connector, SE Connector for purposes of this assessment.
 - The proposed “connector” street approximately one-fourth of a mile west of the eastern border of the sector is designated as East Connector for purposes of this assessment.
 - Figure 2-4 provides a conceptual illustration showing the potential lane and sidewalk configuration.
- **Park Edge Street** would circulate between Paseo del Norte and Unser Boulevard via “right-in/right-out” access to the arterials. Figure 2-6 provides a conceptual illustration of the proposed design options for the “Park Edge Street.”
- **Transit Boulevard** would circulate between Paseo del Norte and Unser Boulevard via “right-in/right-out” access to the arterials. Figure 2-5 provides a conceptual illustration showing the potential lane and sidewalk configuration.

Figure 2-4 Connector Streets (Conceptual Cross Section)

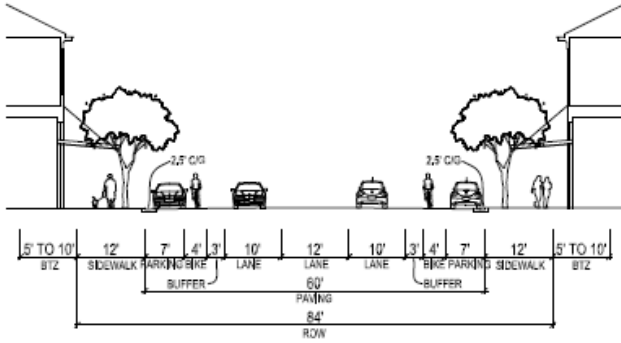

Figure 2-5 Transit Boulevard (Conceptual Cross Section)

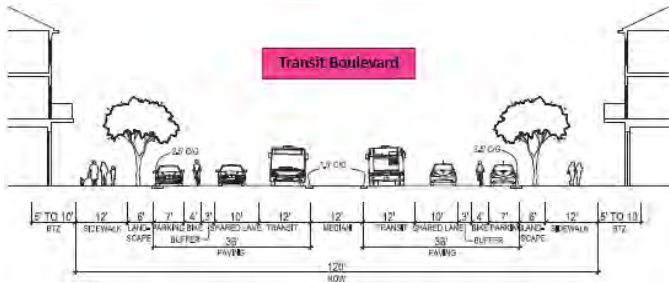
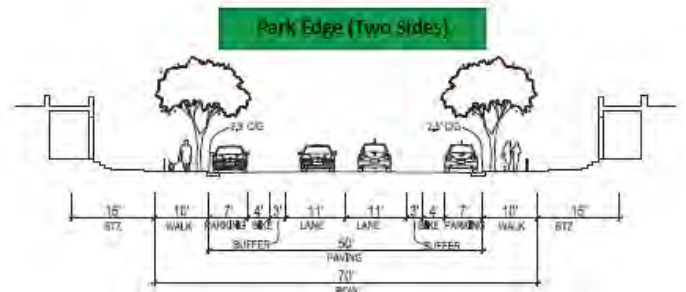
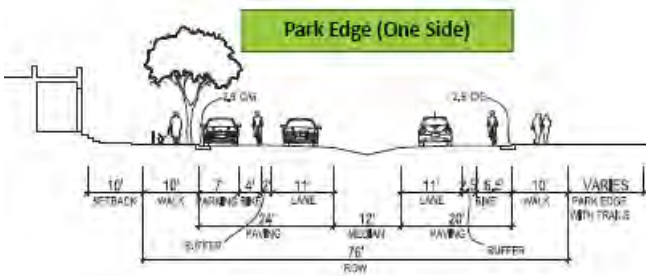

Figure 2-6 Park Edge Street (Conceptual Cross Sections)



Traffic Assessment

This section summarizes the potential effect of the three (3) proposed additional signalized intersections on Paseo del Norte (PDN) as described in the 2012 VHSDP.

Baseline Traffic Conditions

The segment of PDN that passes through the VH sector is approximately 1.75 miles long. Two signalized intersections are currently planned within the VH sector, while a third signalized intersection is located at the intersection of PDN.

Year 2035 Peak Hour Traffic Volumes

Peak-hour traffic volumes, based on the MRCOG model, would occur during the PM Peak Hour:

- 4,500 to 5,000 through vehicles on Paseo del Norte
- 1,500 to 2,000 through vehicles on Unser Boulevard

Baseline Level of Service Forecast

Nelson\Nygaard prepared level of service (LOS) reports for each of the proposed intersections based on forecast Year 2035 “through” volumes, and a conservative estimate of potential turning movements. (See Appendix A, Level of Service Reports).

- Average vehicle delay at arterial intersections on PDN is likely to average 40 to 50 seconds per vehicle, representing acceptable LOS D conditions.
- Average vehicle delay at non-arterial intersections on PDN is likely average 20 to 45 seconds, representing acceptable LOS C or D conditions.
- *Note: With a coordinated signal timing plan, and based on the traffic volumes forecasted for Year 2035, motorists would not be delayed at each intersection. Therefore, the “net” delay of passing through all three signalized intersection on Paseo del Norte would be less than the sum of the average delay at each individual intersection.*

Baseline Travel Time Forecast (Paseo del Norte)

For purposes of this analysis, the Year 2035 average net peak-hour travel time for east/west motorists traveling through the VH sector on Paseo del Norte is estimated to range from 150 to 200 seconds (2.5 to 3.3 minutes) based on an average travel speed of 42 miles per hour, which would allow for a 150-second travel time and would allow for 2-way signal coordination between Universe Boulevard and the planned East Connector (one-half mile east of Unser Boulevard).

- *With a coordinated 2-way signal coordination plan, delay to most east/west motorists could feasibly be limited to just one intersection, with up to 50 seconds of delay.*

Travel Speed Assumptions

The assumptions behind the baseline travel speed estimate are described in more detail below.

Based on the planned “freeway-like” characteristics of PDN, “baseline” conditions for traffic operations on PDN would be as follows:

- Travel speeds of 40 to 50 mph are anticipated during most time periods through 2035; however, delays at key intersections would likely reduce “net” travel time through the corridor, particularly during peak travel periods.
- Estimated net travel time through the corridor would range from approximately 120 to 240 seconds (2 to 4 minutes) based on the following:
 - Potential travel time through the corridor would be:
 - 120 seconds based on 52.5 mph travel speeds.
 - 140 seconds based on 45 mph travel speeds.
 - 150 seconds based on 42 mph travel speeds.
 - Average vehicle delay at the two arterial intersections during peak hours is likely to reach 40 to 50 seconds (average for all vehicles entering the intersection) at both intersections during Year 2035 conditions, based on the signal timing plan that would likely be needed to accommodate a significant volume of turning movements at each of those intersections.
 - Average vehicle at the third planned intersection, with East Connector, would be much less given the lower volume of turning movements at that intersection. With a signal plan that prioritizes east/west traffic at that intersection, average delay to east/west motorist of 10 to 20 seconds may be likely.
 - With a coordinated signal timing plan, potential delay to east/west through movements could be mitigated such that motorists would not be delayed at all three intersections. Rather, a portion of motorists would avoid delay at all three intersections, while many motorists would be delayed at one of the three intersections.
 - Given the width of Paseo del Norte, Unser Boulevard, and Universe Boulevard, 120-second signal cycles are likely to be necessary to accommodate Year 2035 traffic volumes and pedestrian crossings.
 - Based on that cycle length, a travel speed of 42 miles per hour would allow for 2-way signal coordination between Universe Boulevard and the planned East Connector signal location (one-half east of Unser Boulevard). This would result in a 150-second travel time for many motorists, while a portion of motorists would experience delay at signalized intersections, particularly where arterial streets intersect.
 - With a synchronized signal plan, delay to east/west motorist could potentially be reduced such that approximately half of east/west motorists could pass through all three intersections without delay, while the remaining half would likely be delayed at just one intersection. Based on this assumption, the total delay to east/west motorists passing through the 1.75 mile corridor would range from approximately 25 to 50 seconds.

Traffic Assessment: Key Assumptions

Based on the travel speed and initial signal timing assumptions described above, the proposed provision of three additional signalized intersections on Paseo del Norte was evaluated.

Traffic Volume & Turning Movement Assumptions

Nelson\Nygaard assessed the proposed arterial intersection configurations based on the Year 2035 traffic volume forecast described in the MRCOG model.

- **Through movements** at intersection on Paseo del Norte and Unser Boulevard were based directly on the model forecast. This provides a “conservative” assessment, since the actual volume of through movements should ultimately be reduced given the many turning movement options proposed within the VHSDP sector.
- **Turning movement volumes** were estimated based on the forecast of 5,000 external peak hour vehicle trips that would be generated by the VHSDP land uses, as well as a reasonable assumption of the ratio of turning movements to through movements to/from Paseo del Norte.
 - In addition, some assumptions regarding the potential use of the NE and SE Connector streets as “cut-through” routes were also incorporated into the turning movement estimates.

Traffic Signal Assumptions on Paseo Del Norte

Nelson\Nygaard developed a site-specific traffic operations model for the site using Synchro software. The following signal-timing assumptions were incorporated into the assessment:

- Based on the desired travel speeds on Paseo del Norte, the conceptual signal timing plan is based on signal off-sets of 22.5 seconds between signalized intersections at quarter-mile intervals, with a longer off-set of 30 seconds between Unser Boulevard and the proposed NW Connector Street intersection to the west, thus allowing a travel speed of approximately 42 miles per hour (mph).
- Since 22-second off-sets would not allow for 2-way signal coordination at all signalized intersection, a partial “split-phase” signal plan could accommodate the differing arrival times of eastbound and westbound traffic flows at some intersections.
 - *Note: The intersection with Unser Boulevard would have a slight off-set between eastbound and westbound traffic flows, since the eastbound traffic platoon, released by the upstream green-light for eastbound through movements at Universe Boulevard, would arrive approximately 16 seconds earlier than the westbound traffic platoon. This off-set can be accommodated by allowing eastbound left-turns to occur during the initial portion of the cycle (prior to the arrival of most westbound vehicles) while the westbound left-turns would be accommodated with a “lagging” left-turn phase.*

Based on this signal timing concept, the following two types of signal phasing options are included in the Synchro assessment:

- Signal Plan A would allocate 80 seconds to east/west traffic on Paseo del Norte, and 40 seconds to north/south traffic at the two planned intersections with Unser Boulevard and the East Connector Street
 - This signal plan will allow pedestrians to cross Paseo del Norte in a single phase, since 40 seconds would be the minimum pedestrian clearance time (including yellow and red-clearance periods) based on the proposed crossing distance of 120 feet.

- Signal Plan B would allocate 100 seconds to east/west traffic on Paseo del Norte, and 20 seconds to north/south traffic at three proposed signalized intersections, with Transit Boulevard, NE/NW Connector, and SE/SW Connector.
 - This signal plan would require pedestrians to cross Paseo del Norte in two separate crossing phases, since 40 seconds would be the minimum pedestrian clearance time (including yellow and red-clearance periods) for a single-phase based on the proposed crossing distance of 120 feet.
 - Therefore, with this configuration, pedestrians would cross one-half of Paseo del Norte during the north/south traffic phase, and then cross the second half during a separate 20-second pedestrian phase that that could be timed to occur concurrent with non-conflicting eastbound and westbound left-turn movements.
 - Left-turn treatments would potentially vary under Signal Plan B:
 - Side-street approaches: Given the limited time allocated to side-street approaches with this phase, it may be necessary to prohibit left-turn movements on some of the side-street approaches from the Connector Streets. No such left-turn prohibition would be necessary where “T” intersections are proposed, such as the proposed Transit Boulevard.
 - Left-turns from Paseo del Norte: Since eastbound and westbound traffic flows would not be “off-set” at Signal Plan B locations, this provides an opportunity for increased left-turn capacity, from Paseo del Norte to VH at these locations. This will be possible because left-turn movements will be able to occur concurrently with through movements, in one direction at a time, for 20 to 40 seconds during each signal cycle. During such periods, left-turns can effectively be made during gaps in opposing travel flows.

Figure 2-7 Signal Timing Concept: Planned Intersections



Figure 2-8 Signal Timing Concept: Proposed Additional VHSDP Intersections on Paseo del Norte

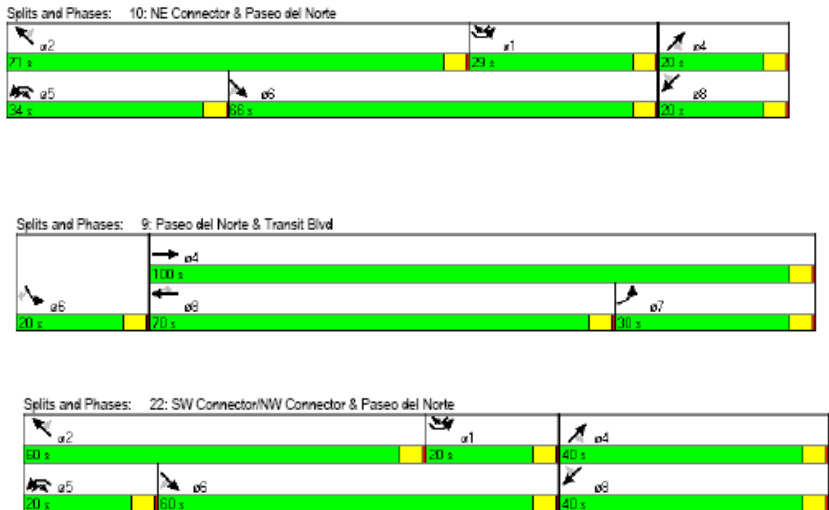

Traffic Assessment Findings

Based on the signal timing assumption described above, three of the proposed additional signalized intersections can be accommodated without significantly affecting traffic operations, and these intersections could ultimately significantly reduce delay at the adjacent intersections if the turning movements at those locations are reduced appropriately.

- Signal coordination on the 1.75-mile segment of Paseo del Norte within the VH sector can be provided with the additional intersections described in the VHSDP, with signal timing off-sets based on 42 mph travel speeds and 120-second signal cycles.
 - This signal coordination would synchronize the intersections of Paseo del Norte with Universe Boulevard and the East Connector (planned intersection one-half mile east of Unser Boulevard) in both directions with a 120-second off-set travel time between those 2 intersections, approximately 1.4 miles apart.
- Site access (inbound to VH from Paseo del Norte) would be enhanced with the additional intersections proposed, particularly if additional time is provided for left-turn movements entering the VH sector from Paseo del Norte at the proposed additional intersections.
 - This site access would reduce left-turn movements at the two currently planned intersections with Unser Boulevard and the East Connector Street.
 - Traffic operations at the intersection with Universe Boulevard is unlikely to be affected.
- Each signalized intersection would operate at an acceptable level of service (LOS) of D or better.

Net Effect on Travel Time

Based on this analysis, the estimated travel time range for east/west motorists traveling through the VH sector on Paseo del Norte is estimated to range from 150 to 230 seconds (2.5 to 3.3 minutes) based on an average travel speed of 42 miles per hour, which would allow for a 150-second travel time and would allow for 2-way signal coordination between Universe Boulevard and the planned East Connector (one-half mile east of Unser Boulevard).

- With a coordinated 2-way signal coordination plan, delay to most east/west motorists could feasibly be limited to just one intersection, with up to 50 seconds of delay.
- With the introduction of three additional intersections, a portion of east/west motorists would be delayed at a second intersection. Average delay at the three additional intersections would be approximately 30 seconds for the eastbound and westbound approaches.

Net Change Resulting from Three Additional Proposed Intersections

Based on this analysis:

- Net travel time would not change for most motorists.
- Some motorists could be delayed by up to 30 seconds at one of the additional three proposed intersections.
- Potential delays could be off-set by reductions in delay at the currently planned arterial intersections, particularly if left-turn volumes at the Unser Boulevard intersection are reduced by the greater dispersal of left-turn movements proposed by the VHSDP street network.

Proposed VHSDP Internal Street Network

The proposed internal circulation network would accommodate most trips to/from VH via the following seven internal streets:

- Four connector street segments with direct connections to both Paseo del Norte and Unser
- Transit Boulevard
- East Connector Street
- Park Edge

In addition to the seven primary access streets, additional internal circulation would be provided by “Town Center Streets,” as shown conceptually on Figure 2-9, as well as a network of local internal blocks with small block sizes.

Figure 2-9 Town Center Street (Conceptual Cross Section)

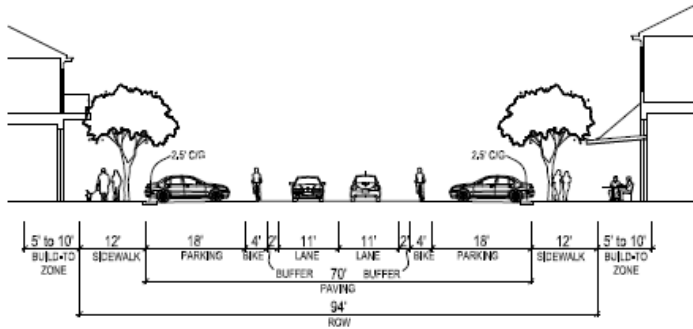
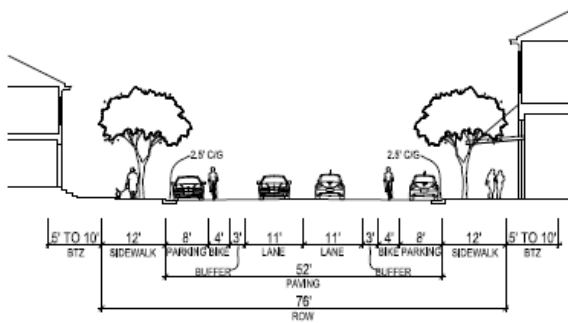

Figure 2-10 Neighborhood Street (Conceptual Cross Section)



Internal Traffic Capacity

Each of the seven primary internal streets, as well as three internal “Town Center Streets,” would have at least two motor vehicle lanes, bicycle lanes, and sidewalks, and most would accommodate on-street parking.

Therefore, each of the internal streets would provide the capacity to accommodate 13,000 or more daily vehicles on each internal street, via multiple entrance and exit paths. Based on the potential dispersal of traffic that would be allowed with multiple entrance and exit points, traffic volumes would be less than 10,000 vehicles per day on any single internal street.

Therefore:

- The proposed internal street network is more than adequate to accommodate the forecasted volume of traffic that be generated by the VHSDP land uses provided that such traffic is dispersed among multiple entrance and exit points (i.e. intersections with Paseo del Norte and/or Unser Boulevard, as proposed in the 2012 VHSDP).
- If the number of entrance and exit points were to be limited to just two or three entrance/exit point, then the volume on those few entrance/exit points would likely require additional travel lanes.

Potential Internal Circulation Constraints

Access to/from Regional Commercial Sites

As described in the 2012 VHSDP, much of the site would be developed with a grid of streets that would maximize internal circulation by providing multiple travel route options and reducing travel distances, particularly by providing small block sizes and a mix of land uses.

However, the portion of the VHSDP sector that borders the intersection of Paseo del Norte and Unser Boulevard would not be developed with the same pattern of internal blocks, due to proximity to the Paseo del Norte and Unser Boulevard, which require much longer spacing between intersections.

- Access to the regional commercial sites along Paseo del Norte and Unser Boulevard from elsewhere in the VH sector will require longer walking distances from within the site to reach a signalized intersection in order to cross these high-traffic volume, multi-lane streets, potentially discouraging those internal trips.
- Circulation between regional commercial sites will be limited, particularly for sites on opposite sides of Paseo del Norte.
- Additional direct multi-modal connections across Paseo del Norte and Unser Boulevard would be a significant safety improvement and benefit to uses on opposite sides of the roadway. As shown on Figure 2-11, such additional multi-modal connections could be provided via grade-separated crossings.

Figure 2-11 Grade-Separated Undercrossing (Example)



3. RELEVANT CASE STUDIES

Based on the forecasted Year 2035 volumes on the two key regional arterials that will provide access to the sector, Paseo del Norte and Unser Boulevard, this section describes the general design and operational characteristics of several arterial streets in other cities for comparative purposes. In particular, the “case studies” cited below are of arterial streets that operate with acceptable levels of service, carrying similar volumes of motor vehicle traffic as forecasted on Paseo del Norte and Unser Boulevard, and include desired characteristics identified in the Sector Plan related to:

- Intersection spacing
- Narrower right-of-way configurations
- Multi-modal circulation elements

Paseo Del Norte Comparison: Lawrence Expressway

The Lawrence Expressway is a regional route through a portion of “Silicon Valley” in the San Francisco Bay Area, running approximately 8 miles from Saratoga Avenue (Saratoga) to US 237 (Sunnyvale) in Santa Clara County. The current and projected daily traffic volumes are similar to those projected for Paseo del Norte, as shown on Figure 3-1.

- Throughout its length the street has three mixed-flow traffic lanes in each direction, plus one high-occupancy vehicle (HOV) lane reserved for use by buses and carpools during peak periods.
- Most intersections are signalized at grade. Where it crosses regional freeways and some major regional streets, it has grade-separated intersections.
- The character of the surrounding area varies – in places sound walls separate the street from residential developments, while the northern half has office developments and large institutions such as hospitals fronting the street.

Figure 3-1 Current and Projected Average Daily Traffic Volumes on Lawrence Expressway

Roadway Segment	Existing (2008)		Future (2035)	
	ADT	LOS	ADT	LOS
Lawrence Expressway between US -101 Central Expressway	79,010	D	93,030	D
Lawrence Expressway between Central Expressway- Kifer Road	63,970	D	80,790	D
Lawrence Expressway between Kifer Road-Monroe Street	67,960	D	83,090	D
Lawrence Expressway between Monroe Street-Cabrillo Avenue	52,890	C	64,760	D
Lawrence Expressway between Cabrillo Avenue-El Camino Real	63,490	D	78,680	D
Lawrence Expressway between El Camino Real-Benton Street	58,230	D	70,840	D
Lawrence Expressway between Benton Street-Homestead Road	65,410	D	66,990	D
Lawrence Expressway between Homestead Road-Pruneridge Avenue	66,600	D	73,220	D
Lawrence Expressway between Pruneridge Avenue-Stevens Creek	62,890	D	68,990	D
Lawrence Expressway between El Camino Real and Reed	71,000	2008-2010 values from City of Sunnyvale 2010 LUTE Update existing conditions analysis		
Lawrence Expressway between Arques Ave and US 101	67,000			

Source: Santa Clara Public Hearing Draft General Plan, Appendix 8.7 Transportation and Mobility Assumptions, except where noted.

Level of Service

Traffic operations on the Lawrence Expressway are projected to remain at level of service D through the horizon year of 2035. While AASHTO defines LOS D as “approaching unstable flow,” in practice this is a fairly reasonable condition that many cities aspire to at peak times, with only slight reductions in vehicle speed and driver comfort. This LOS corresponds with the likely operation of Paseo del Norte at peak capacity.

Intersection Spacing

The distance between signalized intersections along the Lawrence Expressway varies. The table in Figure 3-2 summarizes the distance between the intersections in the segment shown in

Figure 3-3. For this particular segment the distances are very short, between 0.1 and 0.4 miles. While some sections of Lawrence do have greater distances between signalized intersections, the short distances in this segment are fairly typical.

Figure 3-2 Distance Between Signalized Intersections (Example Segment)

Pruneridge Ave and Lehigh Dr	1,455 feet (0.27 mile)
Lehigh Dr and Homestead Rd	905 feet (0.17 mile)
Homestead Rd and Lochinvar Ave	672 feet (0.13 mile)
Lochinvar Ave and Benton St	2,098 feet (0.39 mile)

Lawrence Expressway carries a similar volume of traffic as forecasted for Paseo del Norte and with less than one-fourth mile between signalized intersections on some segments.

Figure 3-3 Aerial View of Lawrence Expressway

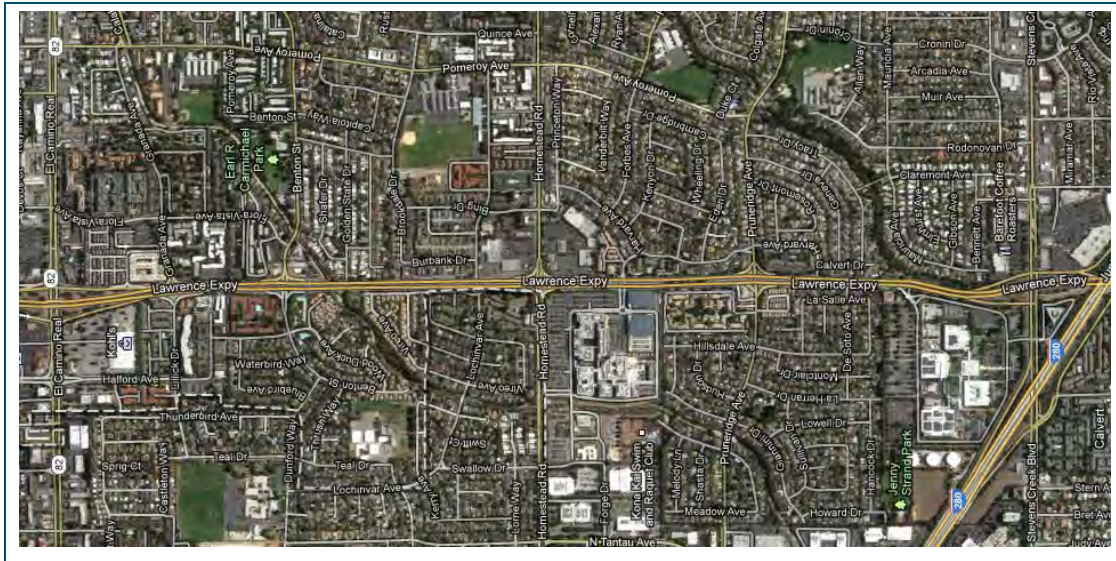

Lawrence Expressway between Junipero Serra (Interstate 280) and El Camino Real (State Route 82)

Source: Google Maps, © Google 2012

General Characteristics

The following images captured from Google Streetview provide an indication of the general nature of the Lawrence Expressway. It is clearly very much an auto-dominated streetscape, with narrow bike lanes and relatively narrow sidewalks with no planted strip separation from the street. In its favor, signalized intersections with crosswalks are closely spaced, which makes for an easier walking experience than if the street had ½ mile spacing between intersections. Newer developments have improved the street by adding planted berms and trees facing the street, as can be seen outside the Kaiser Hospital (below).

Figure 3-4 General Characteristics of Lawrence Expressway (Photo Examples)



Lawrence Expressway at Bollinger Road
Source: Google Maps Streetview, © Google 2012

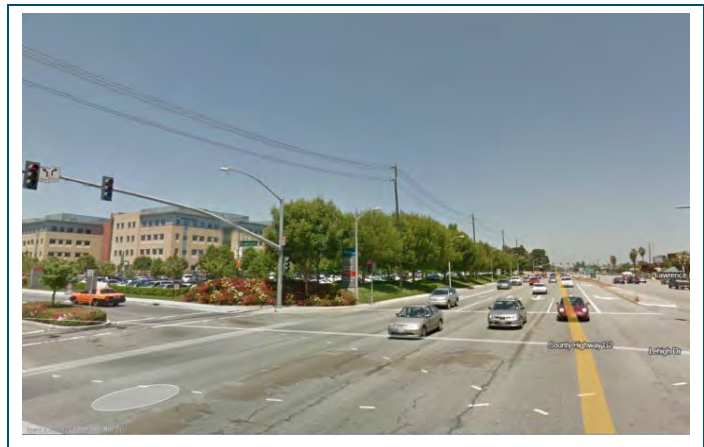

Lawrence Expressway at Lehigh Drive (Kaiser Permanente)
Source: Google Maps Streetview, © Google 2012

Volcano Heights Multi-modal Transportation Assessment
City of Albuquerque Planning Department – August 7, 2012



Lawrence Expressway at Miraloma Way
Source: Google Maps Streetview, © Google 2012



Lawrence Expressway at Prospect Road
Source: Google Maps Streetview, © Google 2012

Unser Boulevard, Comparison 1: Valencia Street

As noted earlier in this report, the forecasted Year 2035 traffic volume on Unser Boulevard is less than 15,000 daily vehicles. The planned roadway configuration includes four travel lanes and a generous median within a 156-foot right-of-way.

In comparison: Valencia Street in San Francisco carries 20,000 daily vehicles and 5,000 daily bicyclists, as well as a very high volumes of pedestrians, with just 2 motor vehicle lanes within a 62.5 foot right-of-way.

- A key advantage of the narrower right-of-way is that relatively short 60-second signal cycles can efficiently accommodate vehicle and pedestrian movements.
- Wider streets, by contrast, require lengthier 90 to 120 second cycles, resulting in lengthier vehicle queues and extended delays, including longer waits for pedestrians between “WALK” intervals.

Figure 3-5 Valencia Street (Photo)



Source: Google Maps Streetview, © Google 2012

Unser Boulevard Comparison 2: Octavia Boulevard

As noted earlier, the forecasted Year 2035 traffic volume on Unser Boulevard is less than 15,000 daily vehicles. The planned roadway configuration includes four travel lanes and a generous median within a 156-foot right-of-way.

In comparison: Octavia Boulevard in San Francisco carries 45,000 daily vehicles with the same number of travel lanes as planned for Unser Boulevard, within a 133-foot wide right-of-way that also accommodates on-street parking within a “boulevard configuration.” The cross-section for Octavia Boulevard, shown in Figure 3-6, has the same components as the cross section proposed for Unser Boulevard within Volcano Heights.

Figure 3-6 Octavia Boulevard Cross Section

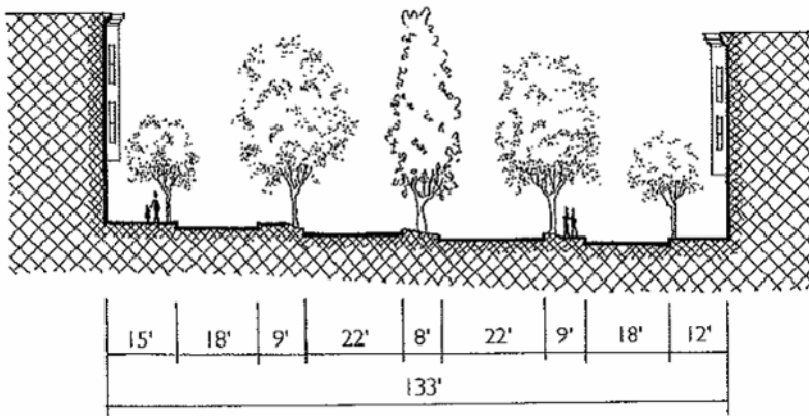

Figure 3-7 Octavia Boulevard Characteristics (Photo Examples)



Appendix A **Signal Timing & Level of Service
Reports**

Note: see Pages 22-24 for overview of turning movement and signal phasing assumptions.

Timings

1: Unser Blvd & Paseo del Norte

7/13/2012



Lane Group	SEL	SET	SER	NWL	NWT	NWR	NEL	NET	NER	SWL	SWT	SWR
Lane Configurations	↑↑	↑↑↑	↑	↑↑	↑↑↑	↑	↑↑	↑↑	↑	↑↑	↑↑	↑
Volume (vph)	200	2032	200	200	2498	200	100	916	100	100	822	100
Turn Type	Prot	NA	pm+ov	Prot	NA	pm+ov	Prot	NA	pm+ov	Prot	NA	pm+ov
Protected Phases	1	6	7	5	2	3	7	4	5	3	8	1
Permitted Phases			6			2			4			8
Detector Phase	1	6	7	5	2	3	7	4	5	3	8	1
Switch Phase												
Minimum Initial (s)	4.0	4.0	4.0	4.0	4.0	4.0	4.0	4.0	4.0	4.0	4.0	4.0
Minimum Split (s)	8.0	40.0	8.0	8.0	40.0	8.0	8.0	40.0	8.0	8.0	40.0	8.0
Total Split (s)	12.0	59.0	8.0	13.0	60.0	8.0	8.0	40.0	13.0	8.0	40.0	12.0
Total Split (%)	10.0%	49.2%	6.7%	10.8%	50.0%	6.7%	6.7%	33.3%	10.8%	6.7%	33.3%	10.0%
Yellow Time (s)	3.5	3.5	3.5	3.5	3.5	3.5	3.5	3.5	3.5	3.5	3.5	3.5
All-Red Time (s)	0.5	0.5	0.5	0.5	0.5	0.5	0.5	0.5	0.5	0.5	0.5	0.5
Lost Time Adjust (s)	0.0	0.0	0.0	0.0	0.0	0.0	0.0	0.0	0.0	0.0	0.0	0.0
Total Lost Time (s)	4.0	4.0	4.0	4.0	4.0	4.0	4.0	4.0	4.0	4.0	4.0	4.0
Lead/Lag	Lead	Lead	Lead	Lag	Lag	Lead	Lead	Lag	Lag	Lead	Lag	Lead
Lead-Lag Optimize?	Yes	Yes	Yes	Yes	Yes	Yes	Yes	Yes	Yes	Yes	Yes	Yes
Recall Mode	None	C-Max	None	None	C-Max	None	None	None	None	None	None	None
Act Effct Green (s)	8.5	55.9	59.9	9.0	56.4	64.4	4.0	35.1	44.1	4.0	35.1	47.6
Actuated g/C Ratio	0.07	0.47	0.50	0.08	0.47	0.54	0.03	0.29	0.37	0.03	0.29	0.40
v/c Ratio	0.85	0.89	0.26	0.80	1.08	0.24	0.90	0.92	0.18	0.90	0.82	0.16
Control Delay	78.8	24.0	4.5	76.3	79.8	21.3	116.4	41.4	21.0	99.9	33.0	15.5
Queue Delay	0.0	0.0	0.0	0.0	0.0	0.0	0.0	0.0	0.0	0.0	0.0	0.0
Total Delay	78.8	24.0	4.5	76.3	79.8	21.3	116.4	41.4	21.0	99.9	33.0	15.5
LOS	E	C	A	E	E	C	F	D	C	F	C	B
Approach Delay		26.9			75.5			46.3			37.9	
Approach LOS		C			E			D			D	

Intersection Summary

Cycle Length: 120

Actuated Cycle Length: 120

Offset: 52 (43%), Referenced to phase 2:NWT and 6:SET, Start of Green

Natural Cycle: 120

Control Type: Actuated-Coordinated

Maximum v/c Ratio: 1.08

Intersection Signal Delay: 50.2

Intersection LOS: D

Intersection Capacity Utilization 96.0%

ICU Level of Service F

Analysis Period (min) 15

Splits and Phases: 1: Unser Blvd & Paseo del Norte

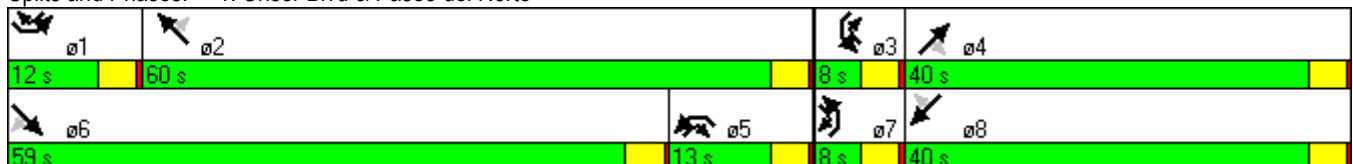

Timings

3: Transit Blvd & Unser Blvd

7/13/2012



Lane Group	EBT	WBL	WBT	NBL	NBR
Lane Configurations	↑↑	↑	↑↑	↑	↑
Volume (vph)	992	300	1458	200	300
Turn Type	NA	Prot	NA	NA	Perm
Protected Phases	4	3	8	2	
Permitted Phases					2
Detector Phase	4	3	8	2	2
Switch Phase					
Minimum Initial (s)	4.0	4.0	4.0	4.0	4.0
Minimum Split (s)	20.0	8.0	20.0	40.0	40.0
Total Split (s)	30.0	20.0	50.0	40.0	40.0
Total Split (%)	33.3%	22.2%	55.6%	44.4%	44.4%
Yellow Time (s)	3.5	3.5	3.5	3.5	3.5
All-Red Time (s)	0.5	0.5	0.5	0.5	0.5
Lost Time Adjust (s)	0.0	0.0	0.0	0.0	0.0
Total Lost Time (s)	4.0	4.0	4.0	4.0	4.0
Lead/Lag	Lag	Lead			
Lead-Lag Optimize?	Yes	Yes			
Recall Mode	None	None	None	C-Max	C-Max
Act Effct Green (s)	26.0	16.0	46.0	36.0	36.0
Actuated g/C Ratio	0.29	0.18	0.51	0.40	0.40
v/c Ratio	0.97	0.95	0.81	0.28	0.37
Control Delay	54.7	78.8	22.7	19.6	3.6
Queue Delay	0.0	0.0	0.0	0.0	0.0
Total Delay	54.7	78.8	22.7	19.6	3.6
LOS	D	E	C	B	A
Approach Delay	54.7		32.3	10.0	
Approach LOS	D		C	B	

Intersection Summary

Cycle Length: 90

Actuated Cycle Length: 90

Offset: 0 (0%), Referenced to phase 2:NBL and 6:, Start of Green

Natural Cycle: 90

Control Type: Actuated-Coordinated

Maximum v/c Ratio: 0.97

Intersection Signal Delay: 35.7

Intersection LOS: D

Intersection Capacity Utilization 65.1%

ICU Level of Service C

Analysis Period (min) 15

Splits and Phases: 3: Transit Blvd & Unser Blvd

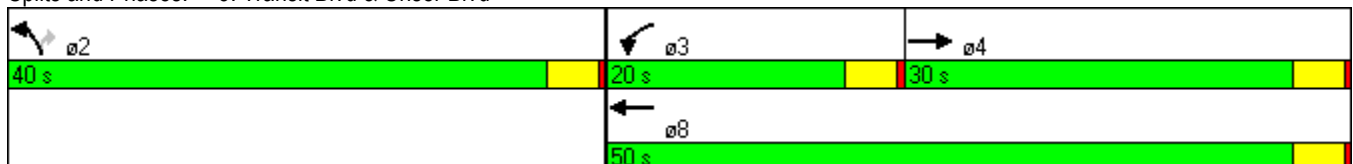

Timings

6: Unser Blvd & SW Connector/SE Connector

7/13/2012



Lane Group	EBL	EBT	EBR	WBL	WBT	WBR	NBL	NBT	SBL	SBT	SBR
Lane Configurations	↖	↗	↘	↖	↗	↘	↖	↑↑	↖	↑↑	↘
Volume (vph)	100	300	100	100	300	100	100	1325	100	993	100
Turn Type	Prot	NA	Perm	Prot	NA	Perm	Prot	NA	Prot	NA	Perm
Protected Phases	7	4		3	8		5	2	1	6	
Permitted Phases			4			8					6
Detector Phase	7	4	4	3	8	8	5	2	1	6	6
Switch Phase											
Minimum Initial (s)	4.0	4.0	4.0	4.0	4.0	4.0	4.0	4.0	4.0	4.0	4.0
Minimum Split (s)	8.0	40.0	40.0	8.0	40.0	40.0	8.0	20.0	8.0	20.0	20.0
Total Split (s)	20.0	40.0	40.0	20.0	40.0	40.0	20.0	40.0	20.0	40.0	40.0
Total Split (%)	16.7%	33.3%	33.3%	16.7%	33.3%	33.3%	16.7%	33.3%	16.7%	33.3%	33.3%
Yellow Time (s)	3.5	3.5	3.5	3.5	3.5	3.5	3.5	3.5	3.5	3.5	3.5
All-Red Time (s)	0.5	0.5	0.5	0.5	0.5	0.5	0.5	0.5	0.5	0.5	0.5
Lost Time Adjust (s)	0.0	0.0	0.0	0.0	0.0	0.0	0.0	0.0	0.0	0.0	0.0
Total Lost Time (s)	4.0	4.0	4.0	4.0	4.0	4.0	4.0	4.0	4.0	4.0	4.0
Lead/Lag	Lead	Lag	Lag	Lead	Lag	Lag	Lead	Lag	Lead	Lag	Lag
Lead-Lag Optimize?	Yes	Yes	Yes	Yes	Yes	Yes	Yes	Yes	Yes	Yes	Yes
Recall Mode	None	None	None	None	None	None	None	C-Max	None	C-Max	C-Max
Act Effct Green (s)	11.9	24.9	24.9	11.9	24.9	24.9	12.3	55.0	12.1	54.8	54.8
Actuated g/C Ratio	0.10	0.21	0.21	0.10	0.21	0.21	0.10	0.46	0.10	0.46	0.46
v/c Ratio	0.57	0.78	0.26	0.57	0.78	0.25	0.57	0.92	0.56	0.64	0.14
Control Delay	63.5	58.1	14.7	64.9	86.1	36.2	63.3	42.2	69.6	26.2	10.7
Queue Delay	0.0	0.0	0.0	0.0	0.0	0.0	0.0	0.0	0.0	0.0	0.0
Total Delay	63.5	58.1	14.7	64.9	86.1	36.2	63.3	42.2	69.6	26.2	10.7
LOS	E	E	B	E	F	D	E	D	E	C	B
Approach Delay		50.5			71.9			43.6		28.5	
Approach LOS		D			E			D		C	

Intersection Summary

Cycle Length: 120

Actuated Cycle Length: 120

Offset: 0 (0%), Referenced to phase 2:NBT and 6:SBT, Start of Green

Natural Cycle: 110

Control Type: Actuated-Coordinated

Maximum v/c Ratio: 0.92

Intersection Signal Delay: 43.5

Intersection LOS: D

Intersection Capacity Utilization 80.0%

ICU Level of Service D

Analysis Period (min) 15

Splits and Phases: 6: Unser Blvd & SW Connector/SE Connector

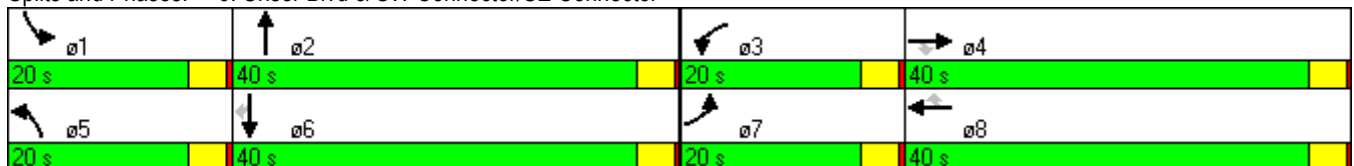

Timings

8: Paseo del Norte & East Connector

7/13/2012



Lane Group	EBL	EBT	EBR	WBL	WBT	WBR	NBL	NBT	NBR	SBL	SBT	SBR
Lane Configurations	↖↖	↑↑↑	↗	↖	↑↑↑	↗	↖	↑	↗	↖	↑	↗
Volume (vph)	200	2409	200	100	2038	200	200	200	200	200	200	200
Turn Type	Prot	NA	Perm	Prot	NA	Perm	Perm	NA	Perm	Perm	NA	Perm
Protected Phases	7	4		3	8			2			6	
Permitted Phases			4			8	2		2	6		6
Detector Phase	7	4	4	3	8	8	2	2	2	6	6	6
Switch Phase												
Minimum Initial (s)	4.0	4.0	4.0	4.0	4.0	4.0	4.0	4.0	4.0	4.0	4.0	4.0
Minimum Split (s)	8.0	20.0	20.0	8.0	20.0	20.0	40.0	40.0	40.0	20.0	20.0	20.0
Total Split (s)	21.0	60.0	60.0	20.0	59.0	59.0	40.0	40.0	40.0	40.0	40.0	40.0
Total Split (%)	17.5%	50.0%	50.0%	16.7%	49.2%	49.2%	33.3%	33.3%	33.3%	33.3%	33.3%	33.3%
Yellow Time (s)	3.5	3.5	3.5	3.5	3.5	3.5	3.5	3.5	3.5	3.5	3.5	3.5
All-Red Time (s)	0.5	0.5	0.5	0.5	0.5	0.5	0.5	0.5	0.5	0.5	0.5	0.5
Lost Time Adjust (s)	0.0	0.0	0.0	0.0	0.0	0.0	0.0	0.0	0.0	0.0	0.0	0.0
Total Lost Time (s)	4.0	4.0	4.0	4.0	4.0	4.0	4.0	4.0	4.0	4.0	4.0	4.0
Lead/Lag	Lead	Lag	Lag	Lead	Lag	Lag						
Lead-Lag Optimize?	Yes											
Recall Mode	None	Max	Max	None	Max	Max	C-Min	C-Min	C-Min	C-Max	C-Max	C-Max
Act Effct Green (s)	12.3	59.9	59.9	12.1	59.7	59.7	36.0	36.0	36.0	36.0	36.0	36.0
Actuated g/C Ratio	0.10	0.50	0.50	0.10	0.50	0.50	0.30	0.30	0.30	0.30	0.30	0.30
v/c Ratio	0.57	0.98	0.23	0.58	0.83	0.23	0.69	0.36	0.33	0.69	0.36	0.33
Control Delay	57.7	46.8	3.4	64.4	30.1	3.1	51.1	35.2	5.8	51.1	35.2	5.8
Queue Delay	0.0	0.0	0.0	0.0	0.0	0.0	0.0	0.0	0.0	0.0	0.0	0.0
Total Delay	57.7	46.8	3.4	64.4	30.1	3.1	51.1	35.2	5.8	51.1	35.2	5.8
LOS	E	D	A	E	C	A	D	D	A	D	D	A
Approach Delay		44.5			29.3			30.7			30.7	
Approach LOS		D			C			C			C	

Intersection Summary

Cycle Length: 120
 Actuated Cycle Length: 120
 Offset: 118 (98%), Referenced to phase 2:NBTL and 6:SBTL, Start of Green
 Natural Cycle: 100
 Control Type: Actuated-Coordinated
 Maximum v/c Ratio: 0.98
 Intersection Signal Delay: 36.3
 Intersection LOS: D
 Intersection Capacity Utilization 87.0%
 ICU Level of Service E
 Analysis Period (min) 15

Splits and Phases: 8: Paseo del Norte & East Connector

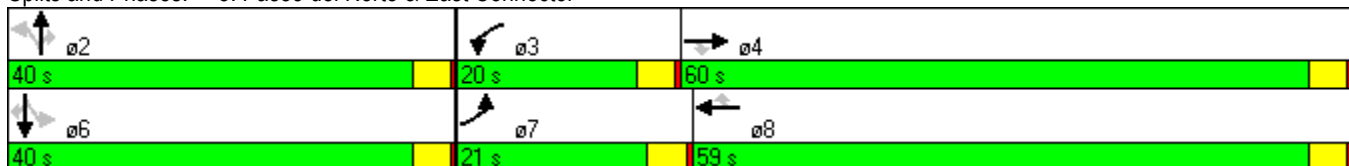

Timings

9: Paseo del Norte & Transit Blvd

7/13/2012

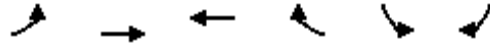

Lane Group	EBL	EBT	WBT	WBR	SBL	SBR
Lane Configurations	↖	↑↑↑	↑↑↑	↗	↖	↗
Volume (vph)	250	2000	2500	250	250	250
Turn Type	Prot	NA	NA	Perm	NA	Perm
Protected Phases	7	4	8		6	
Permitted Phases				8		6
Detector Phase	7	4	8	8	6	6
Switch Phase						
Minimum Initial (s)	4.0	4.0	4.0	4.0	4.0	4.0
Minimum Split (s)	8.0	20.0	20.0	20.0	20.0	20.0
Total Split (s)	30.0	100.0	70.0	70.0	20.0	20.0
Total Split (%)	25.0%	83.3%	58.3%	58.3%	16.7%	16.7%
Yellow Time (s)	3.5	3.5	3.5	3.5	3.5	3.5
All-Red Time (s)	0.5	0.5	0.5	0.5	0.5	0.5
Lost Time Adjust (s)	0.0	0.0	0.0	0.0	0.0	0.0
Total Lost Time (s)	4.0	4.0	4.0	4.0	4.0	4.0
Lead/Lag	Lag		Lead	Lead		
Lead-Lag Optimize?						
Recall Mode	None	C-Max	C-Max	C-Max	Max	Max
Act Effct Green (s)	26.0	96.0	66.0	66.0	16.0	16.0
Actuated g/C Ratio	0.22	0.80	0.55	0.55	0.13	0.13
v/c Ratio	0.65	0.49	0.89	0.26	1.06	0.58
Control Delay	35.2	1.7	27.5	3.6	124.9	11.8
Queue Delay	0.0	0.0	0.0	0.0	0.0	0.0
Total Delay	35.2	1.7	27.5	3.6	124.9	11.8
LOS	D	A	C	A	F	B
Approach Delay		5.4	25.3		68.3	
Approach LOS		A	C		E	

Intersection Summary

Cycle Length: 120

Actuated Cycle Length: 120

Offset: 96 (80%), Referenced to phase 4:EBT and 8:WBT, Start of Green

Natural Cycle: 80

Control Type: Actuated-Coordinated

Maximum v/c Ratio: 1.06

Intersection Signal Delay: 21.1

Intersection LOS: C

Intersection Capacity Utilization 86.0%

ICU Level of Service E

Analysis Period (min) 15

Splits and Phases: 9: Paseo del Norte & Transit Blvd

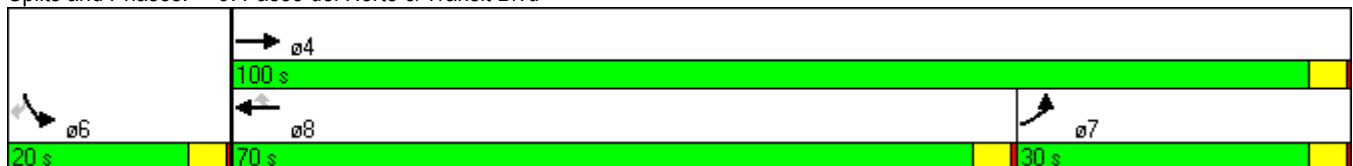

Timings

10: NE Connector & Paseo del Norte

7/13/2012



Lane Group	SEL	SET	SER	NWL	NWT	NWR	NET	NER	SWT	SWR
Lane Configurations	↖	↑↑↑	↗	↖↗	↑↑↑	↗	↑↑	↗	↑↑	↗
Volume (vph)	200	2032	100	300	2498	100	250	500	250	200
Turn Type	Prot	NA	Perm	Prot	NA	Perm	NA	pm+ov	NA	pm+ov
Protected Phases	1	6		5	2		4	5	8	1
Permitted Phases			6			2		4	8	8
Detector Phase	1	6	6	5	2	2	4	5	8	1
Switch Phase										
Minimum Initial (s)	4.0	4.0	4.0	4.0	4.0	4.0	4.0	4.0	4.0	4.0
Minimum Split (s)	8.0	26.0	26.0	20.0	26.0	26.0	20.0	20.0	20.0	8.0
Total Split (s)	29.0	66.0	66.0	34.0	71.0	71.0	20.0	34.0	20.0	29.0
Total Split (%)	24.2%	55.0%	55.0%	28.3%	59.2%	59.2%	16.7%	28.3%	16.7%	24.2%
Yellow Time (s)	3.5	3.5	3.5	3.5	3.5	3.5	3.5	3.5	3.5	3.5
All-Red Time (s)	0.5	0.5	0.5	0.5	0.5	0.5	0.5	0.5	0.5	0.5
Lost Time Adjust (s)	0.0	0.0	0.0	0.0	0.0	0.0	0.0	0.0	0.0	0.0
Total Lost Time (s)	4.0	4.0	4.0	4.0	4.0	4.0	4.0	4.0	4.0	4.0
Lead/Lag	Lag	Lag	Lag	Lead	Lead	Lead		Lead		Lag
Lead-Lag Optimize?	Yes	Yes	Yes	Yes	Yes	Yes		Yes		Yes
Recall Mode	None	Max	Max	Max	C-Max	C-Max	None	Max	None	None
Act Effct Green (s)	25.0	62.0	62.0	32.0	69.0	69.0	14.0	50.0	14.0	43.0
Actuated g/C Ratio	0.21	0.52	0.52	0.27	0.58	0.58	0.12	0.42	0.12	0.36
v/c Ratio	0.62	0.89	0.13	0.38	0.98	0.12	0.67	0.84	0.67	0.39
Control Delay	70.6	51.4	16.6	53.4	39.3	8.4	66.6	45.2	60.8	32.6
Queue Delay	0.0	0.0	0.0	0.0	0.0	0.0	0.0	0.0	0.0	0.0
Total Delay	70.6	51.4	16.6	53.4	39.3	8.4	66.6	45.2	60.8	32.6
LOS	E	D	B	D	D	A	E	D	E	C
Approach Delay		51.5			39.7		52.3		48.3	
Approach LOS		D			D		D		D	

Intersection Summary

Cycle Length: 120
 Actuated Cycle Length: 120
 Offset: 75 (63%), Referenced to phase 2:NWT, Start of Green
 Natural Cycle: 90
 Control Type: Actuated-Coordinated
 Maximum v/c Ratio: 0.98
 Intersection Signal Delay: 46.1
 Intersection LOS: D
 Intersection Capacity Utilization 84.7%
 ICU Level of Service E
 Analysis Period (min) 15

Splits and Phases: 10: NE Connector & Paseo del Norte



Timings

11: Universe & Paseo del Norte

7/13/2012

Lane Group	EBL	EBT	EBR	WBL	WBT	WBR	NBL	NBT	NBR	SBL	SBT	SBR
Lane Configurations												
Volume (vph)	200	1632	200	100	2051	300	200	600	100	500	600	200
Turn Type	Prot	NA	Perm	Prot	NA	Perm	Prot	NA	Perm	Prot	NA	Perm
Protected Phases	7	4		3	8		5	2		1	6	
Permitted Phases			4			8			2			6
Detector Phase	7	4	4	3	8	8	5	2	2	1	6	6
Switch Phase												
Minimum Initial (s)	4.0	4.0	4.0	4.0	4.0	4.0	4.0	4.0	4.0	4.0	4.0	4.0
Minimum Split (s)	8.0	20.0	20.0	8.0	20.0	20.0	8.0	20.0	20.0	8.0	20.0	20.0
Total Split (s)	12.0	57.0	57.0	11.0	56.0	56.0	16.0	29.0	29.0	23.0	36.0	36.0
Total Split (%)	10.0%	47.5%	47.5%	9.2%	46.7%	46.7%	13.3%	24.2%	24.2%	19.2%	30.0%	30.0%
Yellow Time (s)	3.5	3.5	3.5	3.5	3.5	3.5	3.5	3.5	3.5	3.5	3.5	3.5
All-Red Time (s)	0.5	0.5	0.5	0.5	0.5	0.5	0.5	0.5	0.5	0.5	0.5	0.5
Lost Time Adjust (s)	0.0	0.0	0.0	0.0	0.0	0.0	0.0	0.0	0.0	0.0	0.0	0.0
Total Lost Time (s)	4.0	4.0	4.0	4.0	4.0	4.0	4.0	4.0	4.0	4.0	4.0	4.0
Lead/Lag	Lead	Lag	Lag	Lead	Lag	Lag	Lead	Lag	Lag	Lead	Lag	Lag
Lead-Lag Optimize?	Yes	Yes	Yes	Yes	Yes	Yes	Yes	Yes	Yes	Yes	Yes	Yes
Recall Mode	None	None	None	None	None	None	None	C-Max	C-Max	None	C-Max	C-Max
Act Effct Green (s)	8.0	53.1	53.1	6.9	52.0	52.0	11.2	25.0	25.0	19.0	32.8	32.8
Actuated g/C Ratio	0.07	0.44	0.44	0.06	0.43	0.43	0.09	0.21	0.21	0.16	0.27	0.27
v/c Ratio	0.90	0.75	0.26	0.52	0.96	0.39	0.65	0.84	0.25	0.95	0.64	0.40
Control Delay	96.0	30.6	6.0	57.6	47.6	10.1	62.4	57.6	9.3	79.1	42.4	17.0
Queue Delay	0.0	0.0	0.0	0.0	0.0	0.0	0.0	0.0	0.0	0.0	0.0	0.0
Total Delay	96.0	30.6	6.0	57.6	47.6	10.1	62.4	57.6	9.3	79.1	42.4	17.0
LOS	F	C	A	E	D	B	E	E	A	E	D	B
Approach Delay		34.6			43.4			53.3			52.6	
Approach LOS		C			D			D			D	

Intersection Summary

Cycle Length: 120
 Actuated Cycle Length: 120
 Offset: 0 (0%), Referenced to phase 2:NBT and 6:SBT, Start of Green, Master Intersection
 Natural Cycle: 90
 Control Type: Actuated-Coordinated
 Maximum v/c Ratio: 0.96
 Intersection Signal Delay: 43.9
 Intersection LOS: D
 Intersection Capacity Utilization 89.5%
 ICU Level of Service E
 Analysis Period (min) 15

Splits and Phases: 11: Universe & Paseo del Norte

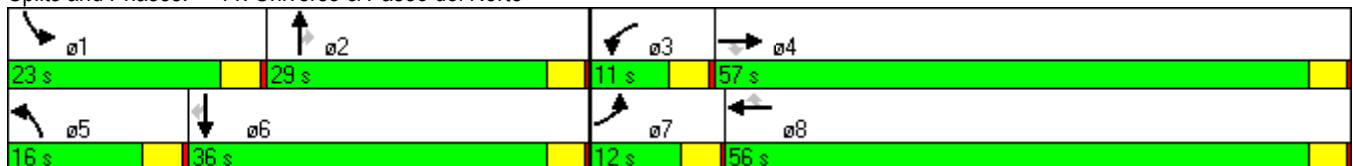

Timings

22: SW Connector/NW Connector & Paseo del Norte

7/13/2012



Lane Group	SEL	SET	SER	NWL	NWT	NWR	NET	NER	SWT	SWR
Lane Configurations	↑↑	↑↑↑	↑	↑↑	↑↑↑	↑	↑↑	↑	↑↑	↑
Volume (vph)	500	2451	250	200	2032	200	300	200	300	500
Turn Type	Prot	NA	Perm	Prot	NA	Perm	NA	pm+ov	NA	pm+ov
Protected Phases	1	6		5	2		4	5	8	1
Permitted Phases			6			2	4	4		8
Detector Phase	1	6	6	5	2	2	4	5	8	1
Switch Phase										
Minimum Initial (s)	4.0	4.0	4.0	4.0	4.0	4.0	4.0	4.0	4.0	4.0
Minimum Split (s)	8.0	40.0	40.0	8.0	22.0	22.0	40.0	8.0	22.0	8.0
Total Split (s)	20.0	60.0	60.0	20.0	60.0	60.0	40.0	20.0	40.0	20.0
Total Split (%)	16.7%	50.0%	50.0%	16.7%	50.0%	50.0%	33.3%	16.7%	33.3%	16.7%
Yellow Time (s)	3.5	3.5	3.5	3.5	3.5	3.5	3.5	3.5	3.5	3.5
All-Red Time (s)	0.5	0.5	0.5	0.5	0.5	0.5	0.5	0.5	0.5	0.5
Lost Time Adjust (s)	0.0	0.0	0.0	0.0	0.0	0.0	0.0	0.0	0.0	0.0
Total Lost Time (s)	4.0	4.0	4.0	4.0	4.0	4.0	4.0	4.0	4.0	4.0
Lead/Lag	Lag	Lag	Lag	Lead	Lead	Lead		Lead		Lag
Lead-Lag Optimize?	Yes	Yes	Yes	Yes	Yes	Yes		Yes		Yes
Recall Mode	None	C-Max	C-Max	None	C-Max	C-Max	None	None	None	None
Act Effct Green (s)	16.0	76.7	76.7	12.5	73.2	73.2	18.8	35.3	18.8	38.8
Actuated g/C Ratio	0.13	0.64	0.64	0.10	0.61	0.61	0.16	0.29	0.16	0.32
v/c Ratio	1.13	0.78	0.24	0.58	0.68	0.20	0.54	0.43	0.54	0.97
Control Delay	129.4	25.0	10.6	37.1	26.8	9.8	49.0	35.0	51.5	73.8
Queue Delay	0.0	0.0	0.0	0.0	0.0	0.0	0.0	0.0	0.0	0.0
Total Delay	129.4	25.0	10.6	37.1	26.8	9.8	49.0	35.0	51.5	73.8
LOS	F	C	B	D	C	A	D	D	D	E
Approach Delay		40.2			26.2		43.4		65.4	
Approach LOS		D			C		D		E	

Intersection Summary

Cycle Length: 120

Actuated Cycle Length: 120

Offset: 22 (18%), Referenced to phase 2:NWT and 6:SET, Start of Green

Natural Cycle: 100

Control Type: Actuated-Coordinated

Maximum v/c Ratio: 1.13

Intersection Signal Delay: 38.4

Intersection LOS: D

Intersection Capacity Utilization 76.9%

ICU Level of Service D

Analysis Period (min) 15

Splits and Phases: 22: SW Connector/NW Connector & Paseo del Norte

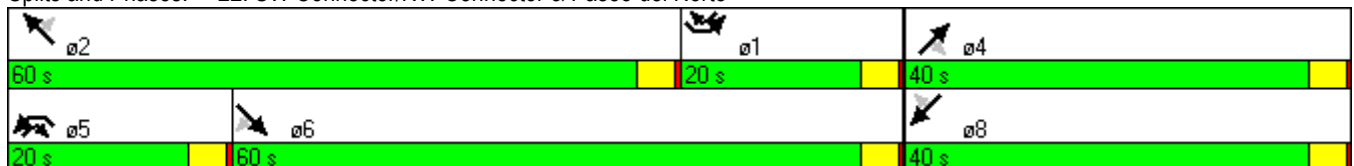

Timings

53: Unser Blvd & NE Connector/NW Connector

7/13/2012



Lane Group	SEL	SET	NWL	NWT	NEL	NET	NER	SWL	SWT	SWR
Lane Configurations	↖↖	↗	↖	↕	↖	↕	↗	↖	↕	↗
Volume (vph)	400	300	200	300	200	800	200	200	900	200
Turn Type	Prot	NA	Prot	NA	Prot	NA	Perm	Prot	NA	Perm
Protected Phases	1	6	5	2	7	4		3	8	
Permitted Phases							4			8
Detector Phase	1	6	5	2	7	4	4	3	8	8
Switch Phase										
Minimum Initial (s)	4.0	4.0	4.0	4.0	4.0	4.0	4.0	4.0	4.0	4.0
Minimum Split (s)	20.0	20.0	8.0	20.0	8.0	20.0	20.0	8.0	20.0	20.0
Total Split (s)	20.0	40.0	20.0	40.0	20.0	40.0	40.0	20.0	40.0	40.0
Total Split (%)	16.7%	33.3%	16.7%	33.3%	16.7%	33.3%	33.3%	16.7%	33.3%	33.3%
Yellow Time (s)	3.5	3.5	3.5	3.5	3.5	3.5	3.5	3.5	3.5	3.5
All-Red Time (s)	0.5	0.5	0.5	0.5	0.5	0.5	0.5	0.5	0.5	0.5
Lost Time Adjust (s)	0.0	0.0	0.0	0.0	0.0	0.0	0.0	0.0	0.0	0.0
Total Lost Time (s)	4.0	4.0	4.0	4.0	4.0	4.0	4.0	4.0	4.0	4.0
Lead/Lag	Lead	Lead	Lag	Lag	Lead	Lag	Lag	Lead	Lag	Lag
Lead-Lag Optimize?	Yes	Yes	Yes	Yes	Yes	Yes	Yes	Yes	Yes	Yes
Recall Mode	Max	C-Max	None	None	None	None	None	None	None	None
Act Effct Green (s)	17.9	37.9	15.5	35.5	15.5	35.1	35.1	15.5	35.1	35.1
Actuated g/C Ratio	0.15	0.32	0.13	0.30	0.13	0.29	0.29	0.13	0.29	0.29
v/c Ratio	0.78	0.87	0.87	0.46	0.87	0.77	0.37	0.87	0.87	0.38
Control Delay	55.8	29.9	85.5	26.0	56.0	51.4	29.4	85.5	50.5	20.1
Queue Delay	0.0	0.0	0.0	0.0	0.0	0.0	0.0	0.0	0.0	0.0
Total Delay	55.8	29.9	85.5	26.0	56.0	51.4	29.4	85.5	50.5	20.1
LOS	E	C	F	C	E	D	C	F	D	C
Approach Delay		41.4		43.0		48.5			51.2	
Approach LOS		D		D		D			D	

Intersection Summary

Cycle Length: 120

Actuated Cycle Length: 120

Offset: 0 (0%), Referenced to phase 6:SET, Start of Green

Natural Cycle: 80

Control Type: Actuated-Coordinated

Maximum v/c Ratio: 0.87

Intersection Signal Delay: 46.9

Intersection LOS: D

Intersection Capacity Utilization 88.4%

ICU Level of Service E

Analysis Period (min) 15

Splits and Phases: 53: Unser Blvd & NE Connector/NW Connector

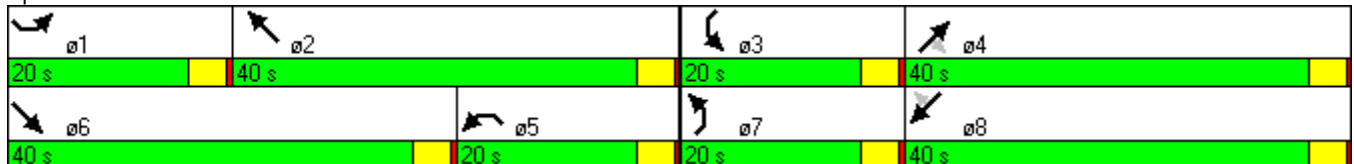



MEMORANDUM

To: Mikaela Renz-Whitmore, City of Albuquerque Planning Department
From: Colin Burgett
Date: UPDATE June 6, 2013
Subject: Volcano Heights Sector Development Plan: Proposed Intersection Spacing

INTRODUCTION & PURPOSE

The purpose of this memorandum is to summarize the assessment of proposed intersection spacing options currently being considered to provide future access from Paseo del Norte and Under Boulevard to future mixed-use development envisioned under the *Volcano Heights Sector Development Plan*.

PROPOSED INTERSECTION SPACING

Four options were identified by City staff for analysis, as shown on Pages 3 through 6:

- **Scheme A:** Spacing as recommended by the Volcano Heights Sector Development Plan (VHSDP)
- **Scheme B:** Spacing based on existing ½ mile full access intersections with right-in/right-out intersections assumed at least every ¼ mile
- **Scheme C:** Compromise spacing based on negotiations with NMDOT, TCC ad hoc committee, and RAC members
- **Scheme D:** Final City Request based on the results of this requested additional analysis

STREET CLASSIFICATIONS

Paseo del Norte and Unser Boulevard are both identified as high-capacity **Principal Arterial** streets. As stated in the New Mexico Department of Transportation Access Management Manual.

The State Access Management Manual provides the following functional definition of Principal Arterials located within urban areas:

State Access Management Manual Chapter 4

E. ACCESS CATEGORY: Urban Principal Arterial (UPA)

(1) Functional Description: The urban principal arterial system serves the major centers of activity of urbanized areas, the highest traffic volume corridors, the longest trip desires, and carries a high proportion of the total urban area travel on a minimum of mileage. The system is integrated both internally and between major rural connections. The principal arterial system carries most of the trips entering and leaving an urban area, as well as most of the through movements bypassing central city areas. In addition, significant intra-area travel, such as between central business districts and outlying residential areas, between major inner city communities, and between major suburban centers, is served by this class of highway. In urbanized areas, this system provides continuity for all rural arterials that intercept the urban boundary.

Scheme A: Volcano Heights Sector Development Plan

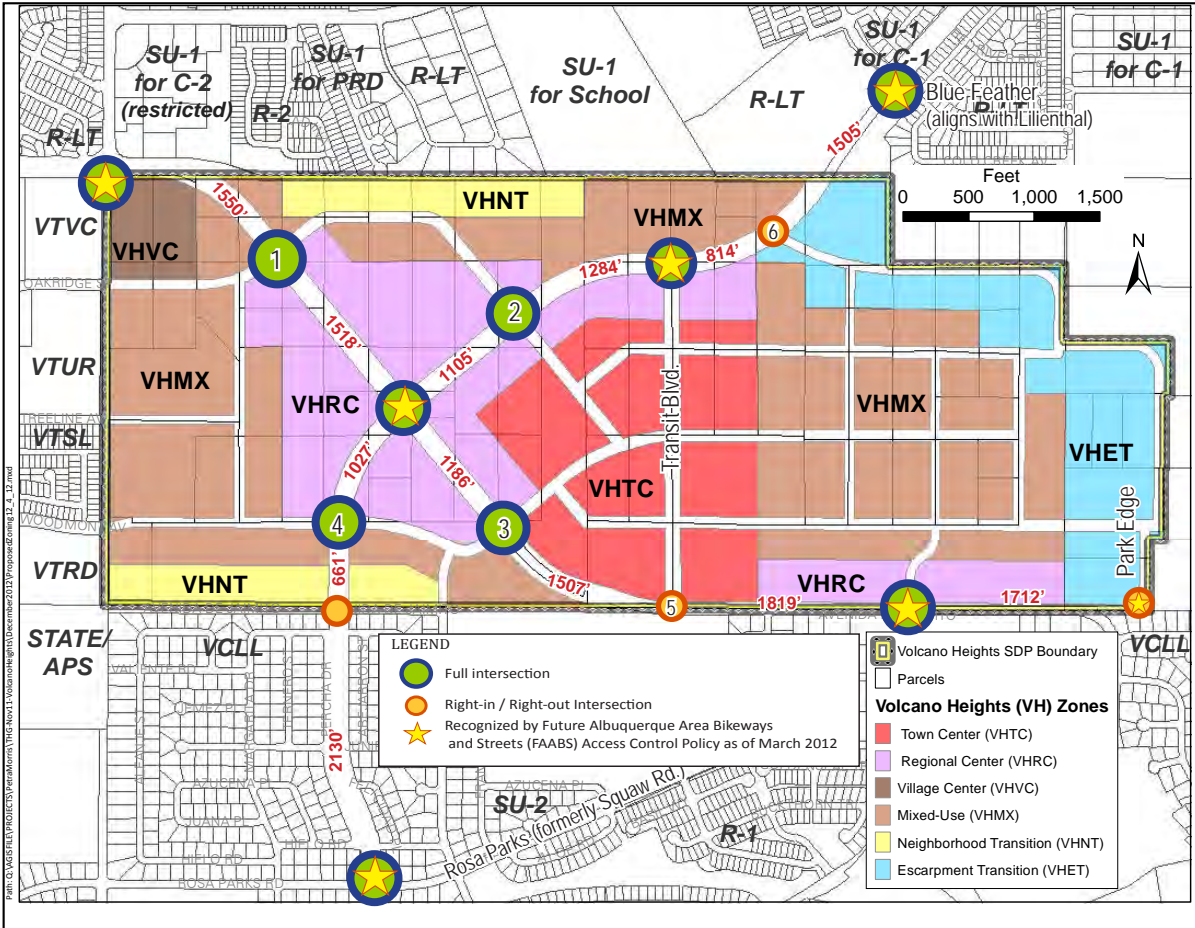

* 1/4 mile = 1320 feet
 1/3 mile = 1760 feet
 1/2 mile = 2640 feet

Scheme C: Compromise Spacing

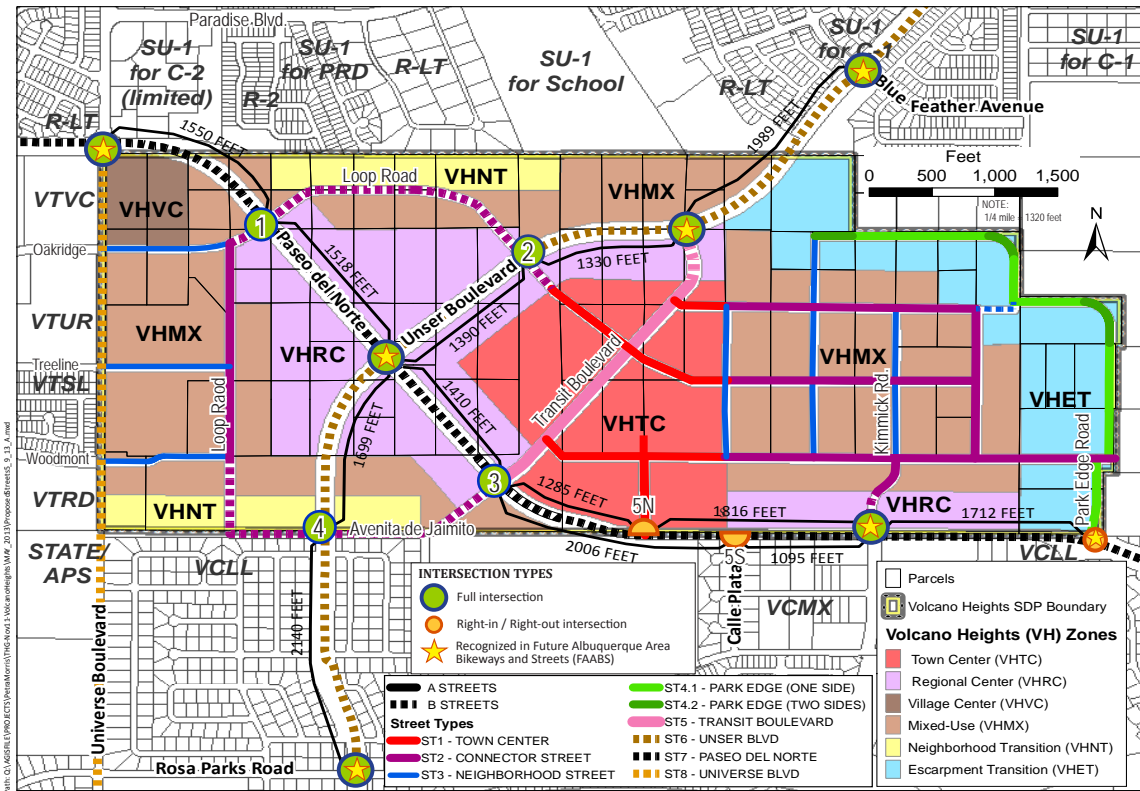

Note: 1/2 mile = 2640 feet
 1/3 mile = 1760 feet
 1/4 mile = 1720 feet

DRAFT

Scheme D: Final City Request

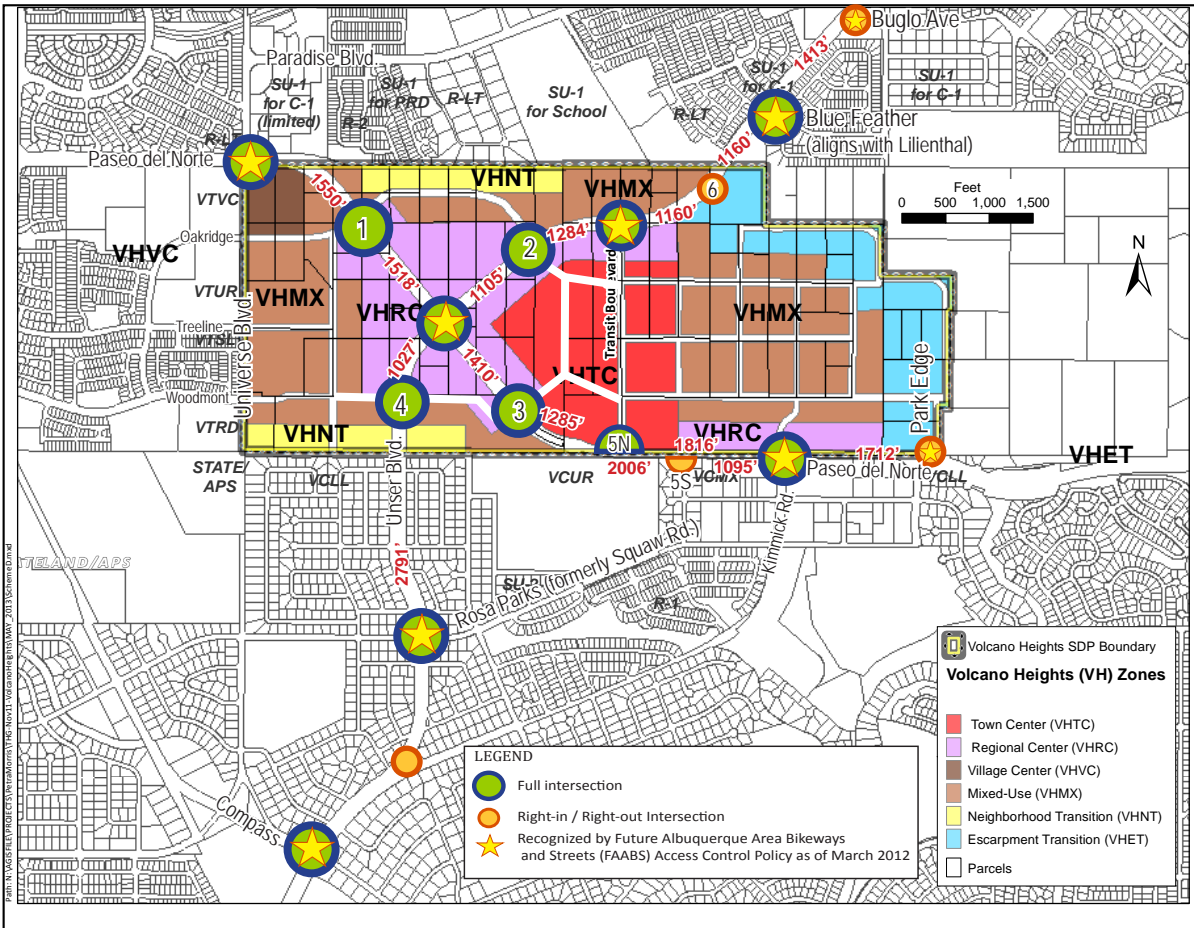

* 1/4 mile = 1320 feet
 1/3 mile = 1760 feet
 1/2 mile = 2640 feet

EVALUATION CRITERIA

This assessment will compare the four schemes based on the following criteria:

- **Intersection Level of Service (LOS):** the State Access Manual identified level of service D or better as acceptable.
- **Average Travel Speed:** Using Synchro analysis software, average travel speed was estimated under each of the four schemes, with a comparison provided.

TRAFFIC VOLUMES

Existing Volumes

Based on May 2013 traffic count data:

- Paseo del Norte currently carries approximately 16,000 daily vehicles (west of Kimmick).
- Unser Boulevard currently carries approximately 11,000 daily vehicles (south of Paradise Drive and north of Paseo del Norte).

Regional Growth

MRCOG Year 2035 model predicts the following future growth:

- Paseo del Norte will carry 53,000 to 63,000 daily vehicles (approximately 5,000 during the PM Peak Hour)
- Unser Boulevard will carry 14,000 to 25,000 daily vehicles (approximately 2,500 during the PM Peak Hour) in the Plan area. MRCOG's model assumes that Unser through the Plan area only carries the traffic market between Universe on the West and Golf Course on the East. Beyond those streets, traffic follows the shortest direction route – largely Rainbow Boulevard to Unser south of the Plan area or Paradise Boulevard to Paseo east of the Plan area.
- The variance in volumes between different segments partially reflects turning movements on/off intersecting arterials, as well as local trip patterns.
- Volcano Heights will attract a large portion of trips:
 - **Approximately 5,000 in & out to trips to/from Volcano Heights during the PM Peak Hour**
 - Based on this forecast: **Approximately 40 percent of vehicles approaching on Paseo del Norte and Unser will be trips beginning or ending at Volcano Heights.**
 - **Therefore: Travel-time goals may need to be balanced with site-access goals, in that Volcano Heights will serve as a key destination, or “regional center.” Inherent in the State Access Manual standards is the function of Principal Arterials: to provide access to and between major centers.**

Volcano Heights SDP: Proposed Intersection Spacing
 City of Albuquerque Planning Department – June 6, 2013

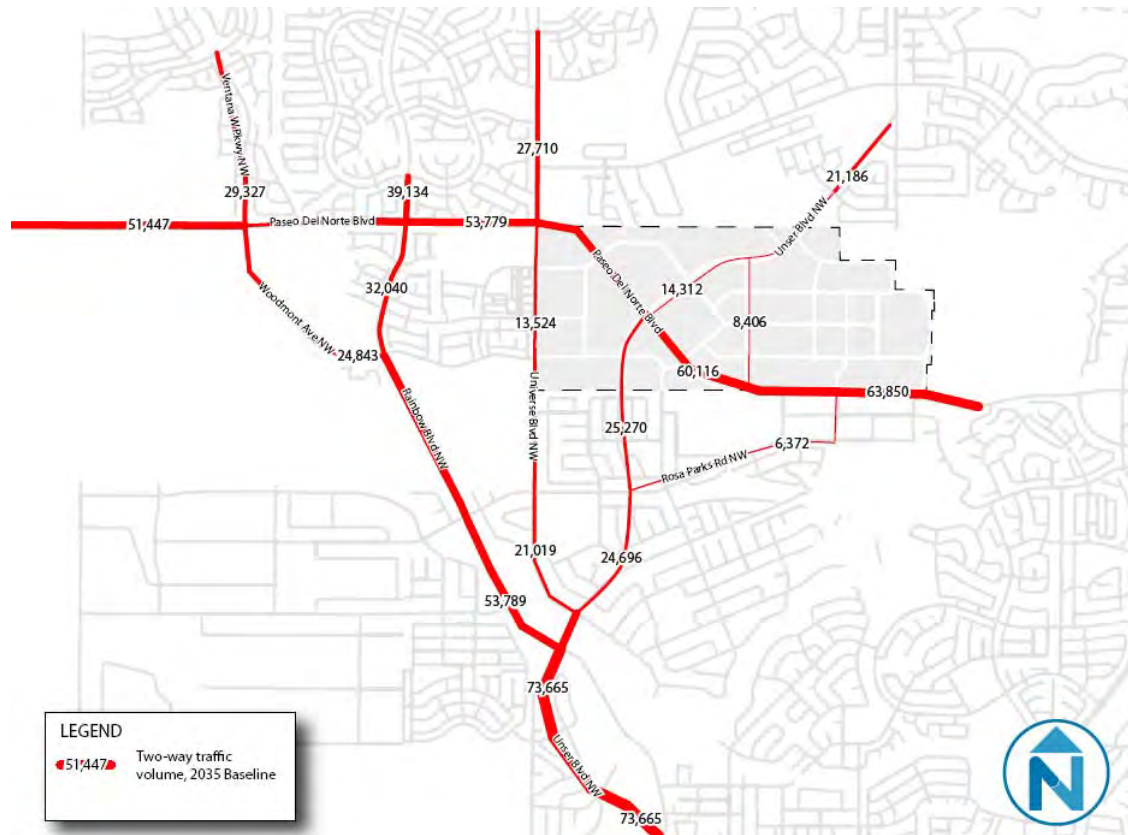

Trips to/from Volcano Heights

Unlike the existing zoning, the land use strategy in the 2012 VHSDP allows mixed-use development, with residences and services within walking or biking distance of each other. This development is intended to serve new residents, nearby residents, as well as regional markets. VHSDP development assumptions for Year 2035 were based on the allowable land uses, as described in the VHSDP, and a market assessment of future demand for office and retail space in the area within the specified timeframe. Based on that assessment, City Planning staff provided the following forecast of Year 2035 land uses:

- 2 million square feet of commercial space including:
 - 1.2 million square feet of office space
 - 800,000 square feet of retail space (mix of regional-serving, local-serving and specialty retail uses)
- 4,769 residential dwelling units consisting of:
 - 4,114 multi-family dwellings
 - 364 single-family detached dwellings
 - 291 single-family attached (rowhouse, townhouse, or duplex) dwellings

Sector Plan Traffic Generation

The steps undertaken to provide a preliminary vehicle trip forecast for proposed Year 2035 land uses under the VHSDP are described below.

Step 1: ITE Baseline Trip Generation

The baseline forecast of trips that would be generated by the Year 2035 land uses within the VHSDP boundaries was derived using trip generation rates for the key land use types provided by the Institute of Transportation Engineers (ITE) *Trip Generation Manual*, 8th edition.

ITE trip generation rates are based on studies of suburban locations, typically “single-use” developments. Such developments typically are located in areas with minimal public transit service and minimal provisions for pedestrian and bicycle circulation. Land uses selected for observation also generally provide separate, free parking facilities for each land use, and nearly all trips to and from such sites are made via private motor vehicle.

ITE chose to collect data at single-use suburban sites precisely to provide a “baseline” forecast of traffic generation that should be adjusted based on local characteristics and site-specific factors, such as:

- Rates of transit ridership and service
- Provisions for pedestrian and bicycle circulation
- Density and mix of land uses, particularly relevant to mixed-use developments, as envisioned in the VHSDP, in which a portion of trips will occur internally, between the various land uses within the sector

Since the baseline trip generation rates for individual land uses are based on data collected at low density development with separated land uses and minimal transit, walking, or biking, ITE cautions that trip generation analysis using ITE rates as a “baseline” must take into account land use and transportation alternatives from the local context in order to be accurate.

The methodology for applying site-specific trip generation factors based on the proposed mix of land uses and proposed street network configuration is described in Steps 2, 3 and 4.

Step 2: Baseline Trip Adjustment to Avoid Double-counting of Internal Trips

Adjustment to account for internal trips to/from retail uses that would otherwise be double-counted, based on ITE internal trip capture data for retail uses (to/from office, residential and other retail uses) in mixed-use developments.

Step 3: Baseline Trip Adjustment to Account for Retail Pass-by Trips

A significant portion of retail trips are “pass-by” trips. Pass-by trip rates are often between 20 and 50 percent of retail trips, generally higher for smaller retail establishments.

This forecast applied a PM Peak Hour pass-by rate of 25 percent for PM Peak derived from ITE logarithm for Shopping Centers applied to the anticipated size of regional retail sites within VH (determined at the block level). Daily pass-by rate conservatively estimated at 15 percent.

Step 4: Bicycle & Walking Trips

The proposed development will have a relatively dense street network, a mix of land uses in close proximity, and street designs that incorporate facilities for bicycle, pedestrian and transit users. Residents and employees living and working in Volcano Heights will have some transportation choice - where different modes may be more convenient at different times, depending on the trip.

Since the ITE average trip generation rates are based on observations made at single-use sites, the ITE average rates will not accurately predict the level of trip generation that would result from the proposed mix of uses at Volcano Heights. Therefore, consistent with the ITE recommended practice, the ITE average rates were adjusted based on local conditions, including the proposed mix of land use types.

To estimate the effect of the proposed mix-use development pattern on trip generation, Nelson\Nygaard utilized the URBEMIS methodology. URBEMIS is a program developed for the California Air Resources Board to calculate vehicle trips and resulting emissions, resulting from new development.

- URBEMIS was developed to more accurately reflect the level of vehicle trip generation resulting from new development, by providing formulas based on specific site characteristics. URBEMIS calculates trip generation rates using the ITE average trip generation rates as a “base.”
- The URBEMIS methodology is designed to offer a useful comparison of the difference in trip generation that can be expected when locating high density development in mixed-use high-density areas with alternative transportation modes available and/or transportation demand management programs in place.

The URBEMIS method employs standard methodologies but provides the opportunity to adjust ITE average rates to quantify the impact of a development’s location, physical characteristics and any demand management programs. In this way, it provides an opportunity to fairly evaluate developments that minimize their transportation impact, for example, through locating close to transit or providing high densities and a mix of uses.

Area Inputs

In addition to requiring the transportation modeler to input the basic land use components of the proposed project (i.e. the number of square feet of each land use), URBEMIS also factors in other area-specific characteristics to determine accurate trip rates. The number of trips generated by a development depends not only on the characteristics of the project itself, but also on the nature of the surrounding area. For example, neighborhood characteristics such as a good balance of housing and jobs, the presence of frequent transit service, and a highly-connected, walkable street network are strongly associated with lower vehicle trip rates. High-density housing added to an existing central city neighborhood, where many shops, services and transit lines already exist, will normally generate fewer trips than the same housing located close to a freeway interchange and surrounded by only low-density housing subdivisions. For this reason, URBEMIS requires data about the area within approximately a half-mile radius from the center of the project, or for the entire project area, whichever is larger. Figure 1-10 shows the key project area characteristics applicable to the URBEMIS methodology.

Area Characteristics Input to URBEMIS Model

Factors
Number of housing units within ½ mile radius
Number of jobs located within ½ mile radius
Local serving retail within ½ mile radius
Transit service
Intersection density within ½ mile radius*
Sidewalk completeness within ½ mile radius
Bike lane completeness within ½ mile radius

Note: * Calculated from proposed street network, based on the number line segment terminations, or each "valence". Intersections have a valence of 3 or higher - a valence of 3 is a "T" intersection, 4 is a four-way intersection, and so on.

It is important to note that the above characteristics do not incorporate any transportation demand management (TDM) measures, such as specific programs, incentives or strategies to reduce trip generation. Rather, they are based entirely on the mix and density of land uses, and the proposed design of the road network.

Step 5: Transit Trip Forecast

For planning purposes, a preliminary "back-of-the-envelope" estimate of potential transit ridership was incorporated into this forecast, which assumed a relatively modest level of transit ridership, 5% of home to work trips for both residential and non-residential land uses, plus daily "non-work" transit trips estimated at 50% of daily work trips by transit. Higher levels of transit ridership are ultimately feasible depending on the ultimate level of transit service and transit incentives.

Step 6: Vehicle Trip Forecast

The resulting vehicle trip forecast is shown on Figure 1-11 for Volcano Heights, while a comparative trip generation forecast based on Conceptual Plan land uses, based on the same methodology, is shown on Figure 1-12.

Volcano Heights SDP: Proposed Intersection Spacing
City of Albuquerque Planning Department – June 6, 2013

Trip Generation Forecast: Volcano Heights Sector Development Plan (Year 2035)

Land Use	No. Units	Trip Generation Rate (see note 1)				Total Trips		
		Daily	AM Peak	PM Peak	Units	Daily	AM Peak	PM Peak
Residential								
Detached	364 (units)	9.57	0.77	1.02	/unit	3,483	280	504
Attached	291 (units)	5.81	0.44	0.52	/unit	1,691	128	151
Multifamily	4,114 (units)	6.65	0.51	0.62	/unit	27,360	2,098	2,551
Hotel	53,600 (ft ²)	8.92	0.64	0.74	/occupied room	797	57	66
Office	1,180,135 (ft ²)	11.01	1.55	1.49	/1,000 ft ²	12,993	1,829	1,758
Retail								
Regional Retail	326,700 (ft ²)	42.94	1.95	7.70	/1,000 ft ²	14,028	638	2,515
Specialty Retail	322,198 (ft ²)	44.32	6.84	5.02	/1,000 ft ²	14,280	2,204	1,617
Local Retail	170,600 (ft ²)	42.94	3.72	12.92	/1,000 ft ²	7,326	635	2,205
<i>Internal Trip Adjustment (see note 2)</i>		-19%	-15%	-20%		-15,679	-1,181	-2,218
<i>Retail Pass-by Trips (see note 3)</i>		-15%	-15%	-25%		-5,345	-522	-1,584
Base Trip Subtotal (VH Sector Development Plan)						60,935	6,168	7,565
<i>Walk & Bicycle Trips (see note 4)</i>		15%	14%	20%		9,070	836	1,550
<i>Transit Trips (see note 5)</i>		3%	5%	4%		2,000	300	300
Total Vehicle Trips Generated						49,865	5,032	5,715
<i>Internal Vehicle Trips (see note 6)</i>		13%	7%	11%		6,509	330	653
<i>External Vehicle Trips (see note 7)</i>		87%	93%	89%		43,356	4,702	5,062
Notes:								
(1) Base trip rates from ITE Trip Generation, 8th Edition. Peak hour trips rates shown for Regional Retail and Local Retail based on fitted curve logarithm applied at block level.								
(2) Adjustment to account for internal trips to/from retail uses that would otherwise be double-counted, based on ITE internal trip capture data for retail uses (to/from office, residential and other retail uses) in mixed-use developments.								
(3) Pass-by rate of 25 percent for PM Peak derived from ITE logarithm for Shopping Centers (while local and specialty retail uses often have higher pass-by rates). Daily pass-by rate conservatively estimated at 15 percent.								
(4) Mode shift for internal trips based on proposed density, mix of uses, block layout, bicycle and pedestrian facilities								
(5) Based on preliminary "back-of-the-envelope" estimate of potential transit ridership. Assumed 5% of home to work trips for both residential and non-residential land uses would occur via transit plus estimated "non-work" transit trips at 50% of								
(6) Total Vehicle Trips derived by subtracting walk & bicycle trips (see note 4) and transit trips (see note 5) from Base Trip Subtotal.								
(7) Derived from estimated internal trips (see note 2), subtracting internal walk & bicycle trips (see note 4) and internal transit trips (estimated at 5% of transit ridership).								
(8) Net vehicle trips derived by subtracting internal vehicle trips (see note 6) from total vehicle trips generated.								

INTERSECTION LEVEL OF SERVICE

Tables 1-1 and 1-2 provide a comparison of intersection level of service (LOS) at signalized intersections. As shown:

- **Failing LOS E would be anticipated under Year 2035 PM Peak Hour conditions at Paseo del Norte & Unser and at Paseo del Norte & Kimmick under Scheme B** (the “baseline” scenario with currently allowed full-access intersections and assumed right-in/right-out intersections at least ¼ mile apart).
- **Acceptable LOS D or C would be achieved at all under intersections under Schemes A, C and D**, due to greater dispersal of movements in & out of VH to multiple intersections. (As noted previously: 40 percent of trips on Paseo del Norte and Unser will be to/from VH land uses).

The LOS analysis was conducted using SYNCHRO 8 software, which evaluates delay taking into account upstream/downstream signal coordination. So for instance: the arrival pattern of traffic platoons (at specific points in each signal cycle) has an effect on average delay.

SIGNAL PROGRESSION & CORRIDOR TRAVEL TIMES

Appendix B provides signal phasing reports, showing the assumed signal phasing at each intersection with 120-second cycles.

- Shorter cycles, while desirable, would not likely be feasible given the size of the intersections, lengthy pedestrian crossing distances (and required crossing times), and conflicting movements (i.e., left-turn phases).

Tables 2-1 and 2-2 provide a comparison of average travel speeds on Paseo del Norte and Unser with the assumed signal progression plan. (Also see Appendix C, Arterial Level of Service reports).

As shown:

- Baseline average travel speed (under Scheme B) would be 25 mph on Unser, and 23 on Paseo del Norte, based on Year 2035 Peak Hour volumes.
- **The net change in travel speed, for “through trips”, under Schemes A, C and D would be approximately 3 mph on Unser, and 1 mph on Paseo del Norte.**
- Based on the predicted net change: the added travel time for through trips would be approximately 15 seconds on both Paseo del Norte (1.5 miles) and Unser (1 mile).
- However, net travel time for trips to/from Volcano Heights would be **reduced** significantly due to the provision of direct access to future employment, services and housing (serving up to 40 percent of trips on Paseo del Norte & Unser).

Volcano Heights SDP: Proposed Intersection Spacing
 City of Albuquerque Planning Department – June 6, 2013

Table 1-1 Level of Service Comparison: Schemes A, B, C, and D

Year 2025 Intersection Level of Service (LOS) PM Peak Hour	Scheme A: VHSDP		Scheme B: Policy		Scheme C: Compromise		Scheme D: Final Request	
	LOS	Avg Delay (seconds)	LOS	Avg Delay (seconds)	LOS	Avg Delay (seconds)	LOS	Avg Delay (seconds)
<i>Paseo del Norte Intersections</i>								
Universe	C	25	C	25	C	25	C	25
Loop Rd -- WEST (proposed –1500' west of Unser)	C	27			C	27	C	27
Unser	D	40	E	58	D	39	D	40
Avenida de Jaimito + Loop Rd East (proposed – 1186' to 1500' east of Unser)	C	34			C	34	C	31
Transit Blvd. (with signalized T-intersection on Paseo del Norte)							A	6
Kimmick Rd	C	34	E	57	D	35	C	32
<i>Unser Boulevard Intersections</i>								
Loop Road – South Intersection (proposed 1000' to 1700' south of Paseo del Norte)	B	16			B	16	B	16
Paseo del Norte	D	40	E	58	D	40	D	40
Loop Road – North Intersection (proposed 1400' north of Unser)	B	16			B	16	B	16
Transit Blvd (2700' north of Paseo del Norte)	C	24	C	28	C	27	C	24
Note: Bold indicates failing level of service (LOS E or worse).								

Volcano Heights SDP: Proposed Intersection Spacing
 City of Albuquerque Planning Department – June 6, 2013

Table 2-1: Travel Speed Comparison (Schemes A, B, C, and D)

Travel Speed Comparison Motor Vehicle Trips through Volcano Heights PM Peak Hour (Year 2035 Volumes)	Scheme A: VHSDP	Scheme B: Policy	Scheme C: Compromise	Scheme D: Final Request
<i>Paseo del Norte</i>				
Eastbound	25 mph	29 mph	24 mph	24 mph
Westbound	20 mph	19 mph	22 mph	20 mph
Overall	22 mph	23 mph	22 mph	22 mph
<i>Unser Boulevard</i>				
Northbound	23 mph	23 mph	21 mph	23 mph
Southbound	21 mph	28 mph	23 mph	21 mph
Overall	22 mph	25 mph	23 mph	22 mph

Appendix A

Synchro Outputs: Travel Speed & Level of Service

Paseo del Norte

























Direction	EB	WB	All
Average Speed (mph)	25	20	22
Total Travel Time (hr)	229	297	525
Distance Traveled (mi)	5629	6070	11699
Performance Index	124.5	188.1	312.6

Unser Blvd

Direction	EB	NB	SW	All
Average Speed (mph)	24	23	21	22
Total Travel Time (hr)	11	58	65	134
Distance Traveled (mi)	267	1301	1392	2959
Performance Index	6.6	37.2	43.1	87.0

























HCM 2010 Signalized Intersection Summary
 11: Universe & Paseo del Norte

Scheme A -- Year 2035 PM
 6/1/2013

												
Movement	EBL	EBT	EBR	WBL	WBT	WBR	NBL	NBT	NBR	SBL	SBT	SBR
Lane Configurations												
Volume (veh/h)	150	1832	54	100	2101	250	104	500	50	150	400	150
Number	7	4	14	3	8	18	5	2	12	1	6	16
Initial Q (Qb), veh	0	0	0	0	0	0	0	0	0	0	0	0
Ped-Bike Adj(A_pbT)	1.00		1.00	1.00		1.00	1.00		1.00	1.00		1.00
Parking Bus Adj	1.00	1.00	1.00	1.00	1.00	1.00	1.00	1.00	1.00	1.00	1.00	1.00
Adj Sat Flow veh/h/ln	186.3	186.3	186.3	186.3	186.3	186.3	186.3	186.3	186.3	186.3	186.3	186.3
Lanes	2	3	1	2	3	1	2	2	1	2	2	1
Cap, veh/h	212	2847	807	157	2730	774	160	736	313	212	792	337
Arrive On Green	0.06	0.51	0.51	0.05	0.49	0.49	0.09	0.39	0.39	0.06	0.21	0.21
Sat Flow, veh/h	3442	5588	1583	3442	5588	1583	3442	3725	1583	3442	3725	1583
Grp Volume(v), veh/h	150	1832	54	100	2101	250	104	500	50	150	400	150
Grp Sat Flow(s),veh/h/ln	1721	1863	1583	1721	1863	1583	1721	1863	1583	1721	1863	1583
Q Serve(g_s), s	4.4	24.5	1.8	2.9	31.5	6.8	3.0	11.4	2.1	4.4	9.7	6.7
Cycle Q Clear(g_c), s	4.4	24.5	1.8	2.9	31.5	6.8	3.0	11.4	2.1	4.4	9.7	6.7
Prop In Lane	1.00		1.00	1.00		1.00	1.00		1.00	1.00		1.00
Lane Grp Cap(c), veh/h	212	2847	807	157	2730	774	160	736	313	212	792	337
V/C Ratio(X)	0.71	0.64	0.07	0.64	0.77	0.32	0.65	0.68	0.16	0.71	0.51	0.45
Avail Cap(c_a), veh/h	235	2847	807	235	2730	774	235	1347	572	235	1347	572
HCM Platoon Ratio	1.00	1.00	1.00	1.00	1.00	1.00	2.00	2.00	2.00	1.00	1.00	1.00
Upstream Filter(I)	1.00	1.00	1.00	0.65	0.65	0.65	1.00	1.00	1.00	1.00	1.00	1.00
Uniform Delay (d), s/veh	47.1	18.3	12.7	48.0	21.4	7.7	45.6	28.3	25.5	47.1	35.5	22.3
Incr Delay (d2), s/veh	8.3	0.5	0.0	2.8	1.4	0.7	4.4	1.1	0.2	8.3	0.5	0.9
Initial Q Delay(d3),s/veh	0.0	0.0	0.0	0.0	0.0	0.0	0.0	0.0	0.0	0.0	0.0	0.0
%ile Back of Q (50%), veh/ln	2.2	10.6	0.6	1.3	14.0	2.4	1.3	4.4	0.8	2.2	4.5	2.6
Lane Grp Delay (d), s/veh	55.4	18.8	12.8	50.8	22.9	8.5	49.9	29.4	25.7	55.4	36.0	23.2
Lane Grp LOS	E	B	B	D	C	A	D	C	C	E	D	C
Approach Vol, veh/h		2036			2451			654			700	
Approach Delay, s/veh		21.4			22.5			32.4			37.4	
Approach LOS		C			C			C			D	
Timer												
Assigned Phs	7	4		3	8		5	2		1	6	
Phs Duration (G+Y+Rc), s	11.3	57.1		9.2	55.0		9.3	25.2		10.8	26.8	
Change Period (Y+Rc), s	5.0	5.0		4.5	5.0		4.5	5.0		4.5	5.0	
Max Green Setting (Gmax), s	7.0	50.0		7.0	50.0		7.0	37.0		7.0	37.0	
Max Q Clear Time (g_c+I1), s	6.4	26.5		4.9	33.5		5.0	13.4		6.4	11.7	
Green Ext Time (p_c), s	0.0	14.9		0.0	12.9		0.0	6.9		0.0	7.0	
Intersection Summary												
HCM 2010 Ctrl Delay			25.0									
HCM 2010 LOS			C									
Notes												

























HCM 2010 Signalized Intersection Summary
 12: Unser Blvd & Paseo del Norte

Scheme A -- Year 2035 PM
 6/1/2013

												
Movement	SEL	SET	SER	NWL	NWT	NWR	NEL	NET	NER	SWL	SWT	SWR
Lane Configurations												
Volume (veh/h)	100	1900	109	150	2411	100	150	905	200	150	792	150
Number	7	4	14	3	8	18	5	2	12	1	6	16
Initial Q (Qb), veh	0	0	0	0	0	0	0	0	0	0	0	0
Ped-Bike Adj(A_pbT)	1.00		0.98	1.00		0.98	0.99		0.97	1.00		0.97
Parking Bus Adj	1.00	1.00	1.00	1.00	1.00	1.00	1.00	1.00	1.00	1.00	1.00	1.00
Adj Sat Flow veh/h/ln	186.3	186.3	186.3	186.3	186.3	186.3	186.3	186.3	186.3	186.3	186.3	186.3
Lanes	2	3	1	2	3	1	2	2	1	2	2	1
Cap, veh/h	155	2222	615	210	2311	715	498	1184	585	386	1183	560
Arrive On Green	0.05	0.40	0.40	0.06	0.41	0.41	0.05	0.32	0.32	0.09	0.64	0.64
Sat Flow, veh/h	3442	5588	1547	3442	5588	1549	3442	3725	1538	3442	3725	1538
Grp Volume(v), veh/h	100	1900	109	150	2411	100	150	905	200	150	792	150
Grp Sat Flow(s),veh/h/ln	1721	1863	1547	1721	1863	1549	1721	1863	1538	1721	1863	1538
Q Serve(g_s), s	3.2	35.1	5.2	4.8	46.8	4.2	3.3	24.8	10.5	3.3	15.3	4.7
Cycle Q Clear(g_c), s	3.2	35.1	5.2	4.8	46.8	4.2	3.3	24.8	10.5	3.3	15.3	4.7
Prop In Lane	1.00		1.00	1.00		1.00	1.00		1.00	1.00		1.00
Lane Grp Cap(c), veh/h	155	2222	615	210	2311	715	498	1184	585	386	1183	560
V/C Ratio(X)	0.65	0.86	0.18	0.72	1.04	0.14	0.30	0.76	0.34	0.39	0.67	0.27
Avail Cap(c_a), veh/h	304	2222	615	304	2311	715	579	1218	599	468	1218	574
HCM Platoon Ratio	1.00	1.00	1.00	1.00	1.00	1.00	1.00	1.00	1.00	2.00	2.00	2.00
Upstream Filter(I)	0.62	0.62	0.62	0.39	0.39	0.39	0.72	0.72	0.72	0.92	0.92	0.92
Uniform Delay (d), s/veh	53.2	31.1	22.1	52.2	33.2	17.6	25.1	34.8	25.1	25.7	16.9	13.1
Incr Delay (d2), s/veh	2.8	2.9	0.4	1.8	25.1	0.2	0.2	2.1	0.2	0.6	1.3	0.2
Initial Q Delay(d3),s/veh	0.0	0.0	0.0	0.0	0.0	0.0	0.0	0.0	0.0	0.0	0.0	0.0
%ile Back of Q (50%), veh/ln	1.5	16.4	2.0	2.2	26.3	1.5	1.4	11.8	3.9	1.3	4.7	1.5
Lane Grp Delay (d), s/veh	55.9	34.0	22.5	54.0	58.3	17.8	25.3	36.9	25.4	26.3	18.1	13.3
Lane Grp LOS	E	C	C	D	F	B	C	D	C	C	B	B
Approach Vol, veh/h		2109			2661			1255			1092	
Approach Delay, s/veh		34.4			56.6			33.7			18.6	
Approach LOS		C			E			C			B	
Timer												
Assigned Phs	7	4		3	8		5	2		1	6	
Phs Duration (G+Y+Rc), s	10.1	50.0		11.9	51.8		10.3	41.0		10.3	41.0	
Change Period (Y+Rc), s	5.0	5.0		5.0	5.0		5.0	5.0		5.0	5.0	
Max Green Setting (Gmax), s	10.0	45.0		10.0	45.0		8.0	37.0		8.0	37.0	
Max Q Clear Time (g_c+I1), s	5.2	37.1		6.8	48.8		5.3	26.8		5.3	17.3	
Green Ext Time (p_c), s	0.1	7.8		0.1	0.0		0.1	7.5		0.1	12.2	
Intersection Summary												
HCM 2010 Ctrl Delay			40.1									
HCM 2010 LOS			D									
Notes												







HCM 2010 Signalized Intersection Summary
 13: Kimmick Rd & Paseo del Norte

Scheme A -- Year 2035 PM
 6/1/2013

												
Movement	EBL	EBT	EBR	WBL	WBT	WBR	NBL	NBT	NBR	SBL	SBT	SBR
Lane Configurations												
Volume (veh/h)	177	1968	100	200	2456	286	141	150	193	150	150	172
Number	7	4	14	3	8	18	5	2	12	1	6	16
Initial Q (Qb), veh	0	0	0	0	0	0	0	0	0	0	0	0
Ped-Bike Adj(A_pbT)	1.00		0.99	1.00		0.99	0.99		0.98	0.99		0.98
Parking Bus Adj	1.00	1.00	1.00	1.00	1.00	1.00	1.00	1.00	1.00	1.00	1.00	1.00
Adj Sat Flow veh/h/ln	186.3	186.3	186.3	186.3	186.3	193.7	186.3	186.3	186.3	186.3	186.3	186.3
Lanes	2	3	1	2	3	1	1	1	1	2	1	1
Cap, veh/h	246	2501	702	270	2540	741	326	429	357	631	429	357
Arrive On Green	0.07	0.45	0.45	0.08	0.45	0.45	0.05	0.23	0.23	0.05	0.23	0.23
Sat Flow, veh/h	3442	5588	1567	3442	5588	1630	1774	1863	1552	3442	1863	1552
Grp Volume(v), veh/h	177	1968	100	200	2456	286	141	150	193	150	150	172
Grp Sat Flow(s),veh/h/ln	1721	1863	1567	1721	1863	1630	1774	1863	1552	1721	1863	1552
Q Serve(g_s), s	5.2	30.8	3.9	5.8	43.8	11.9	5.0	6.9	11.2	3.4	6.9	9.8
Cycle Q Clear(g_c), s	5.2	30.8	3.9	5.8	43.8	11.9	5.0	6.9	11.2	3.4	6.9	9.8
Prop In Lane	1.00		1.00	1.00		1.00	1.00		1.00	1.00		1.00
Lane Grp Cap(c), veh/h	246	2501	702	270	2540	741	326	429	357	631	429	357
V/C Ratio(X)	0.72	0.79	0.14	0.74	0.97	0.39	0.43	0.35	0.54	0.24	0.35	0.48
Avail Cap(c_a), veh/h	403	2508	704	403	2540	741	326	672	560	631	672	560
HCM Platoon Ratio	1.00	1.00	1.00	1.00	1.00	1.00	1.00	1.00	1.00	1.00	1.00	1.00
Upstream Filter(I)	1.00	1.00	1.00	1.00	1.00	1.00	1.00	1.00	1.00	1.00	1.00	1.00
Uniform Delay (d), s/veh	46.6	24.1	16.7	46.2	27.2	18.5	30.5	33.0	34.7	28.1	33.0	34.2
Incr Delay (d2), s/veh	3.9	2.6	0.4	4.0	11.7	1.5	0.9	0.5	1.3	0.2	0.5	1.0
Initial Q Delay(d3),s/veh	0.0	0.0	0.0	0.0	0.0	0.0	0.0	0.0	0.0	0.0	0.0	0.0
%ile Back of Q (50%), veh/ln	2.4	14.1	1.5	2.7	21.6	4.8	0.8	3.3	4.4	1.5	3.3	3.8
Lane Grp Delay (d), s/veh	50.5	26.7	17.1	50.2	38.9	20.0	31.5	33.5	36.0	28.3	33.5	35.2
Lane Grp LOS	D	C	B	D	D	C	C	C	D	C	C	D
Approach Vol, veh/h		2245			2942			484			472	
Approach Delay, s/veh		28.2			37.8			33.9			32.5	
Approach LOS		C			D			C			C	
Timer												
Assigned Phs	7	4		3	8		5	2		1	6	
Phs Duration (G+Y+Rc), s	12.3	50.9		13.0	51.6		10.0	28.6		10.0	28.6	
Change Period (Y+Rc), s	5.0	5.0		5.0	5.0		5.0	5.0		5.0	5.0	
Max Green Setting (Gmax), s	12.0	46.0		12.0	46.0		5.0	37.0		5.0	37.0	
Max Q Clear Time (g_c+I1), s	7.2	32.8		7.8	45.8		7.0	13.2		5.4	11.8	
Green Ext Time (p_c), s	0.2	13.1		0.2	0.2		0.0	3.1		0.0	3.1	
Intersection Summary												
HCM 2010 Ctrl Delay			33.6									
HCM 2010 LOS			C									
Notes												

HCM 2010 Signalized Intersection Summary
 14: Transit Blvd & Unser Blvd

























Scheme A -- Year 2035 PM
 6/1/2013

						
Movement	EBT	EBR	WBL	WBT	NBL	NBR
Lane Configurations	↑↑	↑	↑↑	↑↑	↑	↑
Volume (veh/h)	999	100	182	810	175	309
Number	4	14	3	8	5	12
Initial Q (Qb), veh	0	0	0	0	0	0
Ped-Bike Adj(A_pbT)		0.98	1.00		1.00	1.00
Parking Bus Adj	1.00	1.00	1.00	1.00	1.00	1.00
Adj Sat Flow veh/h/ln	186.3	186.3	186.3	186.3	186.3	186.3
Lanes	2	1	2	2	1	1
Cap, veh/h	1693	708	252	2134	596	532
Arrive On Green	0.45	0.45	0.07	0.57	0.34	0.34
Sat Flow, veh/h	3725	1557	3442	3725	1774	1583
Grp Volume(v), veh/h	999	100	182	810	175	309
Grp Sat Flow(s),veh/h/ln	1863	1557	1721	1863	1774	1583
Q Serve(g_s), s	22.0	4.1	5.7	13.1	8.0	17.7
Cycle Q Clear(g_c), s	22.0	4.1	5.7	13.1	8.0	17.7
Prop In Lane		1.00	1.00		1.00	1.00
Lane Grp Cap(c), veh/h	1693	708	252	2134	596	532
V/C Ratio(X)	0.59	0.14	0.72	0.38	0.29	0.58
Avail Cap(c_a), veh/h	1693	708	563	2134	596	532
HCM Platoon Ratio	1.00	1.00	1.00	1.00	1.00	1.00
Upstream Filter(I)	1.00	1.00	1.00	1.00	1.00	1.00
Uniform Delay (d), s/veh	22.4	17.5	49.9	12.8	26.9	30.1
Incr Delay (d2), s/veh	1.5	0.4	3.9	0.1	1.2	4.6
Initial Q Delay(d3),s/veh	0.0	0.0	0.0	0.0	0.0	0.0
%ile Back of Q (50%), veh/ln	10.2	1.6	2.6	5.4	3.8	7.5
Lane Grp Delay (d), s/veh	23.9	17.9	53.8	12.9	28.1	34.7
Lane Grp LOS	C	B	D	B	C	C
Approach Vol, veh/h	1099			992	484	
Approach Delay, s/veh	23.4			20.4	32.3	
Approach LOS	C			C	C	
Timer						
Assigned Phs	4		3	8		
Phs Duration (G+Y+Rc), s	55.0		13.0	68.0		
Change Period (Y+Rc), s	5.0		5.0	5.0		
Max Green Setting (Gmax), s	50.0		18.0	50.0		
Max Q Clear Time (g_c+I1), s	24.0		7.7	15.1		
Green Ext Time (p_c), s	14.2		0.4	16.5		
Intersection Summary						
HCM 2010 Ctrl Delay			23.9			
HCM 2010 LOS			C			
Notes						

HCM 2010 Signalized Intersection Summary
 101: Paseo del Norte & Loop Rd W/Loop Rd N

Scheme A -- Year 2035 PM

























6/1/2013

												
Movement	EBL	EBT	EBR	WBL	WBT	WBR	SEL	SET	SER	NWL	NWT	NWR
Lane Configurations												
Volume (veh/h)	114	100	246	133	100	137	131	1730	172	262	2200	250
Number	5	2	12	1	6	16	7	4	14	3	8	18
Initial Q (Qb), veh	0	0	0	0	0	0	0	0	0	0	0	0
Ped-Bike Adj(A_pbT)	0.98		0.98	0.99		0.98	1.00		0.98	1.00		0.99
Parking Bus Adj	1.00	1.00	1.00	1.00	1.00	1.00	1.00	1.00	1.00	1.00	1.00	1.00
Adj Sat Flow veh/h/ln	186.3	186.3	186.3	186.3	186.3	186.3	186.3	186.3	193.7	186.3	186.3	193.7
Lanes	1	1	1	1	1	1	1	3	1	1	3	1
Cap, veh/h	312	490	407	289	490	407	169	2823	815	174	2837	826
Arrive On Green	0.26	0.26	0.26	0.26	0.26	0.26	0.10	0.51	0.51	0.20	1.00	1.00
Sat Flow, veh/h	1121	1863	1547	1017	1863	1547	1774	5588	1614	1774	5588	1627
Grp Volume(v), veh/h	114	100	246	133	100	137	131	1730	172	262	2200	250
Grp Sat Flow(s),veh/h/ln	1121	1863	1547	1017	1863	1547	1774	1863	1614	1774	1863	1627
Q Serve(g_s), s	9.9	4.7	15.6	13.1	4.7	8.0	8.1	24.9	6.6	11.0	0.0	0.0
Cycle Q Clear(g_c), s	14.6	4.7	15.6	17.8	4.7	8.0	8.1	24.9	6.6	11.0	0.0	0.0
Prop In Lane	1.00		1.00	1.00		1.00	1.00		1.00	1.00		1.00
Lane Grp Cap(c), veh/h	312	490	407	289	490	407	169	2823	815	174	2837	826
V/C Ratio(X)	0.36	0.20	0.60	0.46	0.20	0.34	0.77	0.61	0.21	1.51	0.78	0.30
Avail Cap(c_a), veh/h	387	614	510	357	614	510	174	2837	819	174	2837	826
HCM Platoon Ratio	1.00	1.00	1.00	1.00	1.00	1.00	1.00	1.00	1.00	2.00	2.00	2.00
Upstream Filter(I)	1.00	1.00	1.00	1.00	1.00	1.00	0.63	0.63	0.63	0.09	0.09	0.09
Uniform Delay (d), s/veh	37.9	32.2	36.2	39.1	32.2	33.4	49.6	19.9	15.4	45.1	0.0	0.0
Incr Delay (d2), s/veh	0.7	0.2	1.4	1.1	0.2	0.5	12.4	0.2	0.1	231.0	0.2	0.1
Initial Q Delay(d3),s/veh	0.0	0.0	0.0	0.0	0.0	0.0	0.0	0.0	0.0	0.0	0.0	0.0
%ile Back of Q (50%), veh/ln	2.9	2.2	6.1	3.5	2.2	3.1	4.2	11.0	2.5	15.5	0.1	0.0
Lane Grp Delay (d), s/veh	38.6	32.4	37.7	40.3	32.4	33.9	62.0	20.1	15.5	276.1	0.2	0.1
Lane Grp LOS	D	C	D	D	C	C	E	C	B	F	A	A
Approach Vol, veh/h		460			370			2033			2712	
Approach Delay, s/veh		36.8			35.8			22.5			26.8	
Approach LOS		D			D			C			C	
Timer												
Assigned Phs		2			6		7	4		3		8
Phs Duration (G+Y+Rc), s		34.5			34.5		15.7	61.7		16.0		62.0
Change Period (Y+Rc), s		5.0			5.0		5.0	5.0		5.0		5.0
Max Green Setting (Gmax), s		37.0			37.0		11.0	57.0		11.0		57.0
Max Q Clear Time (g_c+I1), s		17.6			19.8		10.1	26.9		13.0		2.0
Green Ext Time (p_c), s		3.2			3.1		0.8	16.6		0.0		31.6
Intersection Summary												
HCM 2010 Ctrl Delay			26.7									
HCM 2010 LOS			C									
Notes												

HCM 2010 Signalized Intersection Summary
 102: Unser Blvd & Loop Rd N

























Scheme A -- Year 2035 PM

6/1/2013

												
Movement	SEL	SET	SER	NWL	NWT	NWR	NEL	NET	NER	SWL	SWT	SWR
Lane Configurations												
Volume (veh/h)	100	100	150	150	100	150	131	850	125	100	791	63
Number	1	6	16	5	2	12	7	4	14	3	8	18
Initial Q (Qb), veh	0	0	0	0	0	0	0	0	0	0	0	0
Ped-Bike Adj(A_pbT)	1.00		1.00	1.00		1.00	1.00		1.00	1.00		1.00
Parking Bus Adj	1.00	1.00	1.00	1.00	1.00	1.00	1.00	1.00	1.00	1.00	1.00	1.00
Adj Sat Flow veh/h/ln	186.3	186.3	186.3	186.3	186.3	186.3	186.3	186.3	186.3	186.3	186.3	186.3
Lanes	1	1	1	1	1	1	1	2	1	1	2	1
Cap, veh/h	261	403	343	261	403	343	458	2568	1091	411	2568	1091
Arrive On Green	0.22	0.22	0.22	0.22	0.22	0.22	0.69	0.69	0.69	0.69	0.69	0.69
Sat Flow, veh/h	1125	1863	1583	1125	1863	1583	644	3725	1583	574	3725	1583
Grp Volume(v), veh/h	100	100	150	150	100	150	131	850	125	100	791	63
Grp Sat Flow(s),veh/h/ln	1125	1863	1583	1125	1863	1583	644	1863	1583	574	1863	1583
Q Serve(g_s), s	8.6	4.7	8.7	13.5	4.7	8.7	10.7	9.7	2.8	9.0	8.9	1.4
Cycle Q Clear(g_c), s	13.3	4.7	8.7	18.2	4.7	8.7	19.6	9.7	2.8	18.7	8.9	1.4
Prop In Lane	1.00		1.00	1.00		1.00	1.00		1.00	1.00		1.00
Lane Grp Cap(c), veh/h	261	403	343	261	403	343	458	2568	1091	411	2568	1091
V/C Ratio(X)	0.38	0.25	0.44	0.57	0.25	0.44	0.29	0.33	0.11	0.24	0.31	0.06
Avail Cap(c_a), veh/h	411	651	553	411	651	553	458	2568	1091	411	2568	1091
HCM Platoon Ratio	1.00	1.00	1.00	1.00	1.00	1.00	1.00	1.00	1.00	1.00	1.00	1.00
Upstream Filter(I)	1.00	1.00	1.00	1.00	1.00	1.00	0.53	0.53	0.53	1.00	1.00	1.00
Uniform Delay (d), s/veh	39.9	34.4	35.9	41.9	34.4	35.9	10.4	6.6	5.6	10.4	6.5	5.3
Incr Delay (d2), s/veh	0.9	0.3	0.9	2.0	0.3	0.9	0.8	0.2	0.1	1.4	0.3	0.1
Initial Q Delay(d3),s/veh	0.0	0.0	0.0	0.0	0.0	0.0	0.0	0.0	0.0	0.0	0.0	0.0
%ile Back of Q (50%), veh/ln	2.5	2.3	3.5	4.0	2.3	3.5	1.6	3.7	0.9	1.3	3.4	0.5
Lane Grp Delay (d), s/veh	40.8	34.7	36.8	43.9	34.7	36.8	11.2	6.8	5.7	11.8	6.8	5.4
Lane Grp LOS	D	C	D	D	C	D	B	A	A	B	A	A
Approach Vol, veh/h		350			400			1106			954	
Approach Delay, s/veh		37.3			38.9			7.2			7.2	
Approach LOS		D			D			A			A	
Timer												
Assigned Phs		6			2			4			8	
Phs Duration (G+Y+Rc), s		27.9			27.9			78.0			78.0	
Change Period (Y+Rc), s		5.0			5.0			5.0			5.0	
Max Green Setting (Gmax), s		37.0			37.0			73.0			73.0	
Max Q Clear Time (g_c+I1), s		15.3			20.2			21.6			20.7	
Green Ext Time (p_c), s		2.9			2.7			19.0			19.1	
Intersection Summary												
HCM 2010 Ctrl Delay			15.5									
HCM 2010 LOS			B									
Notes												

























HCM 2010 Signalized Intersection Summary
 103: Avenita de Jaimito/Loop Rd East & Paseo del Norte

Scheme A -- Year 2035 PM
 6/1/2013

												
Movement	SEL	SET	SER	NWL	NWT	NWR	NEL	NET	NER	SWL	SWT	SWR
Lane Configurations												
Volume (veh/h)	200	1800	250	262	2233	343	135	100	272	178	100	293
Number	7	4	14	3	8	18	5	2	12	1	6	16
Initial Q (Qb), veh	0	0	0	0	0	0	0	0	0	0	0	0
Ped-Bike Adj(A_pbT)	1.00		0.99	1.00		0.99	0.99		0.98	0.99		0.98
Parking Bus Adj	1.00	1.00	1.00	1.00	1.00	1.00	1.00	1.00	1.00	1.00	1.00	1.00
Adj Sat Flow veh/h/ln	167.6	167.6	174.4	167.6	167.6	174.4	167.6	167.6	167.6	167.6	167.6	167.6
Lanes	2	3	1	2	3	1	1	1	1	1	1	1
Cap, veh/h	316	2386	694	314	2384	693	282	495	412	286	495	412
Arrive On Green	0.10	0.47	0.47	0.10	0.47	0.47	0.29	0.29	0.29	0.29	0.29	0.29
Sat Flow, veh/h	3097	5029	1463	3097	5029	1463	879	1676	1396	895	1676	1396
Grp Volume(v), veh/h	200	1800	250	262	2233	343	135	100	272	178	100	293
Grp Sat Flow(s),veh/h/ln	1549	1676	1463	1549	1676	1463	879	1676	1396	895	1676	1396
Q Serve(g_s), s	7.2	34.0	12.6	9.6	48.8	18.7	15.8	5.2	19.8	21.6	5.2	21.7
Cycle Q Clear(g_c), s	7.2	34.0	12.6	9.6	48.8	18.7	21.0	5.2	19.8	26.8	5.2	21.7
Prop In Lane	1.00		1.00	1.00		1.00	1.00		1.00	1.00		1.00
Lane Grp Cap(c), veh/h	316	2386	694	314	2384	693	282	495	412	286	495	412
V/C Ratio(X)	0.63	0.75	0.36	0.83	0.94	0.49	0.48	0.20	0.66	0.62	0.20	0.71
Avail Cap(c_a), veh/h	347	2386	694	347	2384	693	303	534	445	307	534	445
HCM Platoon Ratio	1.00	1.00	1.00	1.00	1.00	1.00	1.00	1.00	1.00	1.00	1.00	1.00
Upstream Filter(I)	0.33	0.33	0.33	1.00	1.00	1.00	1.00	1.00	1.00	1.00	1.00	1.00
Uniform Delay (d), s/veh	50.0	25.0	19.3	51.2	28.9	21.0	38.5	30.7	35.8	40.7	30.7	36.5
Incr Delay (d2), s/veh	1.1	0.8	0.5	14.9	8.6	2.5	1.3	0.2	3.3	3.4	0.2	4.8
Initial Q Delay(d3),s/veh	0.0	0.0	0.0	0.0	0.0	0.0	0.0	0.0	0.0	0.0	0.0	0.0
%ile Back of Q (50%), veh/ln	2.9	13.5	4.4	4.4	21.5	7.1	3.7	2.2	7.2	5.3	2.2	8.0
Lane Grp Delay (d), s/veh	51.1	25.7	19.8	66.1	37.5	23.5	39.8	30.9	39.1	44.2	30.9	41.3
Lane Grp LOS	D	C	B	E	D	C	D	C	D	D	C	D
Approach Vol, veh/h		2250			2838			507			571	
Approach Delay, s/veh		27.3			38.4			37.6			40.4	
Approach LOS		C			D			D			D	
Timer												
Assigned Phs	7	4		3	8			2				6
Phs Duration (G+Y+Rc), s	16.8	60.1		16.8	60.0			39.2				39.2
Change Period (Y+Rc), s	5.0	5.0		5.0	5.0			5.0				5.0
Max Green Setting (Gmax), s	13.0	55.0		13.0	55.0			37.0				37.0
Max Q Clear Time (g_c+I1), s	9.2	36.0		11.6	50.8			23.0				28.8
Green Ext Time (p_c), s	2.6	13.4		0.1	3.9			3.7				2.9
Intersection Summary												
HCM 2010 Ctrl Delay				34.5								
HCM 2010 LOS				C								
Notes												

HCM 2010 Signalized Intersection Summary
 104: Unser Blvd & Loop Rd W/Avenida de Jaimito

Scheme A -- Year 2035 PM
 6/1/2013

												
Movement	EBL	EBT	EBR	WBL	WBT	WBR	NBL	NBT	NBR	SBL	SBT	SBR
Lane Configurations												
Volume (veh/h)	50	100	180	180	100	100	121	1105	202	50	800	200
Number	7	4	14	3	8	18	5	2	12	1	6	16
Initial Q (Qb), veh	0	0	0	0	0	0	0	0	0	0	0	0
Ped-Bike Adj(A_pbT)	1.00		1.00	1.00		1.00	1.00		1.00	1.00		1.00
Parking Bus Adj	1.00	1.00	1.00	1.00	1.00	1.00	1.00	1.00	1.00	1.00	1.00	1.00
Adj Sat Flow veh/h/ln	186.3	186.3	186.3	186.3	186.3	186.3	186.3	186.3	186.3	186.3	186.3	186.3
Lanes	1	1	1	1	1	1	1	2	1	1	2	1
Cap, veh/h	435	639	544	410	639	544	316	2059	875	228	2059	875
Arrive On Green	0.34	0.34	0.34	0.34	0.34	0.34	0.55	0.55	0.55	0.55	0.55	0.55
Sat Flow, veh/h	1178	1863	1583	1095	1863	1583	561	3725	1583	419	3725	1583
Grp Volume(v), veh/h	50	100	180	180	100	100	121	1105	202	50	800	200
Grp Sat Flow(s),veh/h/ln	1178	1863	1583	1095	1863	1583	561	1863	1583	419	1863	1583
Q Serve(g_s), s	3.0	3.6	8.1	13.1	3.6	4.3	15.1	18.1	6.3	8.3	11.8	6.2
Cycle Q Clear(g_c), s	6.5	3.6	8.1	16.7	3.6	4.3	26.8	18.1	6.3	26.4	11.8	6.2
Prop In Lane	1.00		1.00	1.00		1.00	1.00		1.00	1.00		1.00
Lane Grp Cap(c), veh/h	435	639	544	410	639	544	316	2059	875	228	2059	875
V/C Ratio(X)	0.11	0.16	0.33	0.44	0.16	0.18	0.38	0.54	0.23	0.22	0.39	0.23
Avail Cap(c_a), veh/h	435	639	544	410	639	544	456	2984	1268	332	2984	1268
HCM Platoon Ratio	1.00	1.00	1.00	1.00	1.00	1.00	1.00	1.00	1.00	1.00	1.00	1.00
Upstream Filter(I)	1.00	1.00	1.00	1.00	1.00	1.00	0.46	0.46	0.46	0.66	0.66	0.66
Uniform Delay (d), s/veh	24.2	21.9	23.4	27.7	21.9	22.1	19.9	13.7	11.0	22.1	12.2	11.0
Incr Delay (d2), s/veh	0.5	0.5	1.6	3.4	0.5	0.7	0.4	0.1	0.1	0.3	0.1	0.1
Initial Q Delay(d3),s/veh	0.0	0.0	0.0	0.0	0.0	0.0	0.0	0.0	0.0	0.0	0.0	0.0
%ile Back of Q (50%), veh/ln	0.9	1.8	3.4	3.9	1.8	1.8	2.0	7.4	2.1	0.9	4.8	2.1
Lane Grp Delay (d), s/veh	24.7	22.4	25.0	31.1	22.4	22.9	20.2	13.8	11.1	22.4	12.3	11.1
Lane Grp LOS	C	C	C	C	C	C	C	B	B	C	B	B
Approach Vol, veh/h		330			380			1428			1050	
Approach Delay, s/veh		24.2			26.6			13.9			12.6	
Approach LOS		C			C			B			B	
Timer												
Assigned Phs		4			8			2			6	
Phs Duration (G+Y+Rc), s		38.0			38.0			58.1			58.1	
Change Period (Y+Rc), s		5.0			5.0			5.0			5.0	
Max Green Setting (Gmax), s		33.0			33.0			77.0			77.0	
Max Q Clear Time (g_c+I1), s		10.1			18.7			28.8			28.4	
Green Ext Time (p_c), s		2.8			2.5			24.3			24.4	
Intersection Summary												
HCM 2010 Ctrl Delay				16.1								
HCM 2010 LOS				B								
Notes												

Paseo del Norte

























Direction	EB	WB	All
Average Speed (mph)	29	19	23
Total Travel Time (hr)	190	332	522
Distance Traveled (mi)	5591	6155	11746
Performance Index	85.1	221.8	306.9

Unser Blvd

Direction	EB	NB	SW	All
Average Speed (mph)	18	24	28	25
Total Travel Time (hr)	11	57	65	133
Distance Traveled (mi)	204	1361	1798	3363
Performance Index	8.4	37.0	34.9	80.3























HCM 2010 Signalized Intersection Summary
 11: Universe & Paseo del Norte

Scheme B -- Year 2035 PM
 6/1/2013

												
Movement	EBL	EBT	EBR	WBL	WBT	WBR	NBL	NBT	NBR	SBL	SBT	SBR
Lane Configurations												
Volume (veh/h)	150	1832	54	100	2101	250	104	500	50	150	400	150
Number	7	4	14	3	8	18	5	2	12	1	6	16
Initial Q (Qb), veh	0	0	0	0	0	0	0	0	0	0	0	0
Ped-Bike Adj(A_pbT)	1.00		1.00	1.00		1.00	1.00		1.00	1.00		1.00
Parking Bus Adj	1.00	1.00	1.00	1.00	1.00	1.00	1.00	1.00	1.00	1.00	1.00	1.00
Adj Sat Flow veh/h/ln	186.3	186.3	186.3	186.3	186.3	186.3	186.3	186.3	186.3	186.3	186.3	186.3
Lanes	2	3	1	2	3	1	2	2	1	2	2	1
Cap, veh/h	212	2847	807	157	2730	774	160	736	313	212	792	337
Arrive On Green	0.06	0.51	0.51	0.05	0.49	0.49	0.09	0.39	0.39	0.06	0.21	0.21
Sat Flow, veh/h	3442	5588	1583	3442	5588	1583	3442	3725	1583	3442	3725	1583
Grp Volume(v), veh/h	150	1832	54	100	2101	250	104	500	50	150	400	150
Grp Sat Flow(s),veh/h/ln	1721	1863	1583	1721	1863	1583	1721	1863	1583	1721	1863	1583
Q Serve(g_s), s	4.4	24.5	1.8	2.9	31.5	6.8	3.0	11.4	2.1	4.4	9.7	6.7
Cycle Q Clear(g_c), s	4.4	24.5	1.8	2.9	31.5	6.8	3.0	11.4	2.1	4.4	9.7	6.7
Prop In Lane	1.00		1.00	1.00		1.00	1.00		1.00	1.00		1.00
Lane Grp Cap(c), veh/h	212	2847	807	157	2730	774	160	736	313	212	792	337
V/C Ratio(X)	0.71	0.64	0.07	0.64	0.77	0.32	0.65	0.68	0.16	0.71	0.51	0.45
Avail Cap(c_a), veh/h	235	2847	807	235	2730	774	235	1347	572	235	1347	572
HCM Platoon Ratio	1.00	1.00	1.00	1.00	1.00	1.00	2.00	2.00	2.00	1.00	1.00	1.00
Upstream Filter(I)	1.00	1.00	1.00	1.00	1.00	1.00	1.00	1.00	1.00	1.00	1.00	1.00
Uniform Delay (d), s/veh	47.1	18.3	12.7	48.0	21.4	7.7	45.6	28.3	25.5	47.1	35.5	22.3
Incr Delay (d2), s/veh	8.3	0.5	0.0	4.2	2.2	1.1	4.4	1.1	0.2	8.3	0.5	0.9
Initial Q Delay(d3),s/veh	0.0	0.0	0.0	0.0	0.0	0.0	0.0	0.0	0.0	0.0	0.0	0.0
%ile Back of Q (50%), veh/ln	2.2	10.6	0.6	1.4	14.2	2.5	1.3	4.4	0.8	2.2	4.5	2.6
Lane Grp Delay (d), s/veh	55.4	18.8	12.8	52.2	23.6	8.8	49.9	29.4	25.7	55.4	36.0	23.2
Lane Grp LOS	E	B	B	D	C	A	D	C	C	E	D	C
Approach Vol, veh/h		2036			2451			654			700	
Approach Delay, s/veh		21.4			23.3			32.4			37.4	
Approach LOS		C			C			C			D	
Timer												
Assigned Phs	7	4		3	8		5	2		1	6	
Phs Duration (G+Y+Rc), s	11.3	57.1		9.2	55.0		9.3	25.2		10.8	26.8	
Change Period (Y+Rc), s	5.0	5.0		4.5	5.0		4.5	5.0		4.5	5.0	
Max Green Setting (Gmax), s	7.0	50.0		7.0	50.0		7.0	37.0		7.0	37.0	
Max Q Clear Time (g_c+I1), s	6.4	26.5		4.9	33.5		5.0	13.4		6.4	11.7	
Green Ext Time (p_c), s	0.0	14.9		0.0	12.9		0.0	6.9		0.0	7.0	
Intersection Summary												
HCM 2010 Ctrl Delay			25.3									
HCM 2010 LOS			C									
Notes												

HCM 2010 Signalized Intersection Summary
 12: Unser Blvd & Paseo del Norte

Scheme B -- Year 2035 PM
 6/1/2013

























												
Movement	SEL	SET	SER	NWL	NWT	NWR	NEU	NEL	NET	NER	SWL	SWT
Lane Configurations												
Volume (veh/h)	281	1725	109	412	2264	100	121	242	814	250	217	658
Number	7	4	14	3	8	18		5	2	12	1	6
Initial Q (Qb), veh	0	0	0	0	0	0		0	0	0	0	0
Ped-Bike Adj(A_pbT)	1.00		0.97	1.00		0.98		0.99		0.97	1.00	
Parking Bus Adj	1.00	1.00	1.00	1.00	1.00	1.00		1.00	1.00	1.00	1.00	1.00
Adj Sat Flow veh/h/ln	186.3	186.3	186.3	186.3	186.3	186.3		186.3	186.3	186.3	186.3	186.3
Lanes	2	3	1	2	3	1		2	2	1	2	2
Cap, veh/h	343	1901	524	439	2056	664		536	1123	665	440	1107
Arrive On Green	0.10	0.34	0.34	0.13	0.37	0.37		0.07	0.30	0.30	0.06	0.30
Sat Flow, veh/h	3442	5588	1541	3442	5588	1545		3442	3725	1536	3442	3725
Grp Volume(v), veh/h	281	1725	109	412	2264	100		242	814	250	217	658
Grp Sat Flow(s),veh/h/ln	1721	1863	1541	1721	1863	1545		1721	1863	1536	1721	1863
Q Serve(g_s), s	9.4	34.7	5.9	14.0	43.3	4.7		5.6	23.0	13.1	5.1	17.7
Cycle Q Clear(g_c), s	9.4	34.7	5.9	14.0	43.3	4.7		5.6	23.0	13.1	5.1	17.7
Prop In Lane	1.00		1.00	1.00		1.00		1.00		1.00	1.00	
Lane Grp Cap(c), veh/h	343	1901	524	439	2056	664		536	1123	665	440	1107
V/C Ratio(X)	0.82	0.91	0.21	0.94	1.10	0.15		0.45	0.72	0.38	0.49	0.59
Avail Cap(c_a), veh/h	439	1901	524	439	2056	664		546	1172	685	465	1172
HCM Platoon Ratio	1.00	1.00	1.00	1.00	1.00	1.00		1.00	1.00	1.00	1.00	1.00
Upstream Filter(I)	1.00	1.00	1.00	1.00	1.00	1.00		1.00	1.00	1.00	1.00	1.00
Uniform Delay (d), s/veh	51.9	37.0	27.6	50.8	37.2	20.5		27.1	36.7	22.9	28.6	35.3
Incr Delay (d2), s/veh	9.3	7.8	0.9	28.1	53.6	0.5		0.6	2.2	0.4	0.9	0.7
Initial Q Delay(d3),s/veh	0.0	0.0	0.0	0.0	0.0	0.0		0.0	0.0	0.0	0.0	0.0
%ile Back of Q (50%), veh/ln	4.5	17.2	2.3	7.8	30.0	1.8		2.4	11.0	4.9	2.2	8.2
Lane Grp Delay (d), s/veh	61.1	44.9	28.5	78.9	90.8	21.0		27.7	38.9	23.2	29.5	36.0
Lane Grp LOS	E	D	C	E	F	C		C	D	C	C	D
Approach Vol, veh/h		2115			2776				1306			1025
Approach Delay, s/veh		46.2			86.5				33.8			32.9
Approach LOS		D			F				C			C
Timer												
Assigned Phs	7	4		3	8			5	2		1	6
Phs Duration (G+Y+Rc), s	16.7	45.0		20.0	48.3			12.7	40.5		12.1	39.9
Change Period (Y+Rc), s	5.0	5.0		5.0	5.0			5.0	5.0		5.0	5.0
Max Green Setting (Gmax), s	15.0	40.0		15.0	40.0			8.0	37.0		8.0	37.0
Max Q Clear Time (g_c+I1), s	11.4	36.7		16.0	45.3			7.6	25.0		7.1	19.7
Green Ext Time (p_c), s	0.3	3.3		0.0	0.0			0.0	7.9		0.1	10.1
Intersection Summary												
HCM 2010 Ctrl Delay			57.6									
HCM 2010 LOS			E									
Notes												



Movement	SWR
Lane Configurations	7
Volume (veh/h)	150
Number	16
Initial Q (Qb), veh	0
Ped-Bike Adj(A_pbT)	0.97
Parking Bus Adj	1.00
Adj Sat Flow veh/h/ln	186.3
Lanes	1
Cap, veh/h	614
Arrive On Green	0.30
Sat Flow, veh/h	1535
Grp Volume(v), veh/h	150
Grp Sat Flow(s),veh/h/ln	1535
Q Serve(g_s), s	7.7
Cycle Q Clear(g_c), s	7.7
Prop In Lane	1.00
Lane Grp Cap(c), veh/h	614
V/C Ratio(X)	0.24
Avail Cap(c_a), veh/h	641
HCM Platoon Ratio	1.00
Upstream Filter(l)	1.00
Uniform Delay (d), s/veh	23.7
Incr Delay (d2), s/veh	0.2
Initial Q Delay(d3),s/veh	0.0
%ile Back of Q (50%), veh/ln	2.8
Lane Grp Delay (d), s/veh	23.9
Lane Grp LOS	C
Approach Vol, veh/h	
Approach Delay, s/veh	
Approach LOS	
Timer	
Assigned Phs	
Phs Duration (G+Y+Rc), s	
Change Period (Y+Rc), s	
Max Green Setting (Gmax), s	
Max Q Clear Time (g_c+I1), s	
Green Ext Time (p_c), s	
Intersection Summary	















HCM 2010 Signalized Intersection Summary
 13: Kimmick Rd & Paseo del Norte

Scheme B -- Year 2035 PM
 6/1/2013

												
Movement	EBL	EBT	EBR	WBL	WBT	WBR	NBL	NBT	NBR	SBL	SBT	SBR
Lane Configurations												
Volume (veh/h)	377	1640	100	200	2456	286	141	150	293	378	150	172
Number	7	4	14	3	8	18	5	2	12	1	6	16
Initial Q (Qb), veh	0	0	0	0	0	0	0	0	0	0	0	0
Ped-Bike Adj(A_pbT)	1.00		0.99	1.00		0.99	0.99		0.98	0.99		0.98
Parking Bus Adj	1.00	1.00	1.00	1.00	1.00	1.00	1.00	1.00	1.00	1.00	1.00	1.00
Adj Sat Flow veh/h/ln	186.3	186.3	186.3	186.3	186.3	193.7	186.3	186.3	186.3	186.3	186.3	186.3
Lanes	2	3	1	2	3	1	1	1	1	2	1	1
Cap, veh/h	307	2368	664	260	2292	668	379	484	405	697	484	405
Arrive On Green	0.09	0.42	0.42	0.08	0.41	0.41	0.06	0.26	0.26	0.06	0.26	0.26
Sat Flow, veh/h	3442	5588	1567	3442	5588	1629	1774	1863	1556	3442	1863	1556
Grp Volume(v), veh/h	377	1640	100	200	2456	286	141	150	293	378	150	172
Grp Sat Flow(s),veh/h/ln	1721	1863	1567	1721	1863	1629	1774	1863	1556	1721	1863	1556
Q Serve(g_s), s	10.0	26.9	4.4	6.4	46.0	14.1	6.6	7.3	19.3	7.0	7.3	10.3
Cycle Q Clear(g_c), s	10.0	26.9	4.4	6.4	46.0	14.1	6.6	7.3	19.3	7.0	7.3	10.3
Prop In Lane	1.00		1.00	1.00		1.00	1.00		1.00	1.00		1.00
Lane Grp Cap(c), veh/h	307	2368	664	260	2292	668	379	484	405	697	484	405
V/C Ratio(X)	1.23	0.69	0.15	0.77	1.07	0.43	0.37	0.31	0.72	0.54	0.31	0.43
Avail Cap(c_a), veh/h	307	2368	664	307	2292	668	379	614	513	697	614	513
HCM Platoon Ratio	1.00	1.00	1.00	1.00	1.00	1.00	1.00	1.00	1.00	1.00	1.00	1.00
Upstream Filter(I)	1.00	1.00	1.00	1.00	1.00	1.00	1.00	1.00	1.00	1.00	1.00	1.00
Uniform Delay (d), s/veh	51.1	26.4	19.9	50.9	33.1	23.7	28.2	33.4	37.8	31.0	33.4	34.5
Incr Delay (d2), s/veh	128.2	1.7	0.5	9.6	41.4	2.0	0.6	0.4	3.7	0.9	0.4	0.7
Initial Q Delay(d3),s/veh	0.0	0.0	0.0	0.0	0.0	0.0	0.0	0.0	0.0	0.0	0.0	0.0
%ile Back of Q (50%), veh/ln	9.8	12.4	1.7	3.1	29.6	5.9	3.0	3.5	7.8	1.4	3.5	4.0
Lane Grp Delay (d), s/veh	179.3	28.1	20.4	60.5	74.5	25.7	28.9	33.8	41.5	31.9	33.8	35.2
Lane Grp LOS	F	C	C	E	F	C	C	C	D	C	C	D
Approach Vol, veh/h		2117			2942			584			700	
Approach Delay, s/veh		54.6			68.8			36.5			33.1	
Approach LOS		D			E			D			C	
Timer												
Assigned Phs	7	4		3	8		5	2		1		6
Phs Duration (G+Y+Rc), s	15.0	52.5		13.5	51.0		12.0	34.2		12.0		34.2
Change Period (Y+Rc), s	5.0	5.0		5.0	5.0		5.0	5.0		5.0		5.0
Max Green Setting (Gmax), s	10.0	46.0		10.0	46.0		7.0	37.0		7.0		37.0
Max Q Clear Time (g_c+I1), s	12.0	28.9		8.4	48.0		8.6	21.3		9.0		12.3
Green Ext Time (p_c), s	0.0	16.8		0.1	0.0		0.0	3.1		0.0		3.5
Intersection Summary												
HCM 2010 Ctrl Delay				57.1								
HCM 2010 LOS				E								
Notes												

HCM 2010 Signalized Intersection Summary
 14: Transit Blvd & Unser Blvd

Scheme B -- Year 2035 PM
 6/1/2013

							
Movement	EBU	EBT	EBR	WBL	WBT	NBL	NBR
Lane Configurations							
Volume (veh/h)	131	899	50	182	810	275	459
Number		4	14	3	8	5	12
Initial Q (Qb), veh		0	0	0	0	0	0
Ped-Bike Adj(A_pbT)			0.98	1.00		1.00	1.00
Parking Bus Adj		1.00	1.00	1.00	1.00	1.00	1.00
Adj Sat Flow veh/h/ln		186.3	186.3	186.3	186.3	186.3	186.3
Lanes		2	1	2	2	1	1
Cap, veh/h		1693	708	252	2134	596	532
Arrive On Green		0.45	0.45	0.07	0.57	0.34	0.34
Sat Flow, veh/h		3725	1557	3442	3725	1774	1583
Grp Volume(v), veh/h		899	50	182	810	275	459
Grp Sat Flow(s),veh/h/ln		1863	1557	1721	1863	1774	1583
Q Serve(g_s), s		19.1	2.0	5.7	13.1	13.4	29.8
Cycle Q Clear(g_c), s		19.1	2.0	5.7	13.1	13.4	29.8
Prop In Lane			1.00	1.00		1.00	1.00
Lane Grp Cap(c), veh/h		1693	708	252	2134	596	532
V/C Ratio(X)		0.53	0.07	0.72	0.38	0.46	0.86
Avail Cap(c_a), veh/h		1693	708	563	2134	596	532
HCM Platoon Ratio		1.00	1.00	1.00	1.00	1.00	1.00
Upstream Filter(I)		1.00	1.00	1.00	1.00	1.00	1.00
Uniform Delay (d), s/veh		21.6	16.9	49.9	12.8	28.7	34.1
Incr Delay (d2), s/veh		1.2	0.2	3.9	0.1	2.6	16.7
Initial Q Delay(d3),s/veh		0.0	0.0	0.0	0.0	0.0	0.0
%ile Back of Q (50%), veh/ln		8.8	0.8	2.6	5.4	6.5	13.9
Lane Grp Delay (d), s/veh		22.8	17.1	53.8	12.9	31.2	50.8
Lane Grp LOS		C	B	D	B	C	D
Approach Vol, veh/h		949			992	734	
Approach Delay, s/veh		22.5			20.4	43.5	
Approach LOS		C			C	D	
Timer							
Assigned Phs		4		3	8		
Phs Duration (G+Y+Rc), s		55.0		13.0	68.0		
Change Period (Y+Rc), s		5.0		5.0	5.0		
Max Green Setting (Gmax), s		50.0		18.0	50.0		
Max Q Clear Time (g_c+I1), s		21.1		7.7	15.1		
Green Ext Time (p_c), s		13.8		0.4	15.0		
Intersection Summary							
HCM 2010 Ctrl Delay			27.5				
HCM 2010 LOS			C				
Notes							

Paseo del Norte

























Direction	EB	WB	All
Average Speed (mph)	24	20	22
Total Travel Time (hr)	232	315	546
Distance Traveled (mi)	5668	6154	11821
Performance Index	127.6	205.2	332.8

Unser Blvd

Direction	EB	NB	SW	All
Average Speed (mph)	28	22	23	23
Total Travel Time (hr)	9	57	76	143
Distance Traveled (mi)	260	1284	1771	3314
Performance Index	5.0	36.5	46.3	87.9

























HCM 2010 Signalized Intersection Summary
 11: Universe & Paseo del Norte

Scheme C -- Year 2035 PM
 6/1/2013

												
Movement	EBL	EBT	EBR	WBL	WBT	WBR	NBL	NBT	NBR	SBL	SBT	SBR
Lane Configurations												
Volume (veh/h)	150	1832	54	100	2101	250	104	500	50	150	400	150
Number	7	4	14	3	8	18	5	2	12	1	6	16
Initial Q (Qb), veh	0	0	0	0	0	0	0	0	0	0	0	0
Ped-Bike Adj(A_pbT)	1.00		1.00	1.00		1.00	1.00		1.00	1.00		1.00
Parking Bus Adj	1.00	1.00	1.00	1.00	1.00	1.00	1.00	1.00	1.00	1.00	1.00	1.00
Adj Sat Flow veh/h/ln	186.3	186.3	186.3	186.3	186.3	186.3	186.3	186.3	186.3	186.3	186.3	186.3
Lanes	2	3	1	2	3	1	2	2	1	2	2	1
Cap, veh/h	212	2847	807	157	2730	774	160	736	313	212	792	337
Arrive On Green	0.06	0.51	0.51	0.05	0.49	0.49	0.09	0.39	0.39	0.06	0.21	0.21
Sat Flow, veh/h	3442	5588	1583	3442	5588	1583	3442	3725	1583	3442	3725	1583
Grp Volume(v), veh/h	150	1832	54	100	2101	250	104	500	50	150	400	150
Grp Sat Flow(s),veh/h/ln	1721	1863	1583	1721	1863	1583	1721	1863	1583	1721	1863	1583
Q Serve(g_s), s	4.4	24.5	1.8	2.9	31.5	6.8	3.0	11.4	2.1	4.4	9.7	6.7
Cycle Q Clear(g_c), s	4.4	24.5	1.8	2.9	31.5	6.8	3.0	11.4	2.1	4.4	9.7	6.7
Prop In Lane	1.00		1.00	1.00		1.00	1.00		1.00	1.00		1.00
Lane Grp Cap(c), veh/h	212	2847	807	157	2730	774	160	736	313	212	792	337
V/C Ratio(X)	0.71	0.64	0.07	0.64	0.77	0.32	0.65	0.68	0.16	0.71	0.51	0.45
Avail Cap(c_a), veh/h	235	2847	807	235	2730	774	235	1347	572	235	1347	572
HCM Platoon Ratio	1.00	1.00	1.00	1.00	1.00	1.00	2.00	2.00	2.00	1.00	1.00	1.00
Upstream Filter(I)	1.00	1.00	1.00	0.61	0.61	0.61	1.00	1.00	1.00	1.00	1.00	1.00
Uniform Delay (d), s/veh	47.1	18.3	12.7	48.0	21.4	7.7	45.6	28.3	25.5	47.1	35.5	22.3
Incr Delay (d2), s/veh	8.3	0.5	0.0	2.6	1.3	0.7	4.4	1.1	0.2	8.3	0.5	0.9
Initial Q Delay(d3),s/veh	0.0	0.0	0.0	0.0	0.0	0.0	0.0	0.0	0.0	0.0	0.0	0.0
%ile Back of Q (50%), veh/ln	2.2	10.6	0.6	1.3	14.0	2.4	1.3	4.4	0.8	2.2	4.5	2.6
Lane Grp Delay (d), s/veh	55.4	18.8	12.8	50.6	22.8	8.4	49.9	29.4	25.7	55.4	36.0	23.2
Lane Grp LOS	E	B	B	D	C	A	D	C	C	E	D	C
Approach Vol, veh/h		2036			2451			654			700	
Approach Delay, s/veh		21.4			22.4			32.4			37.4	
Approach LOS		C			C			C			D	
Timer												
Assigned Phs	7	4		3	8		5	2		1	6	
Phs Duration (G+Y+Rc), s	11.3	57.1		9.2	55.0		9.3	25.2		10.8	26.8	
Change Period (Y+Rc), s	5.0	5.0		4.5	5.0		4.5	5.0		4.5	5.0	
Max Green Setting (Gmax), s	7.0	50.0		7.0	50.0		7.0	37.0		7.0	37.0	
Max Q Clear Time (g_c+I1), s	6.4	26.5		4.9	33.5		5.0	13.4		6.4	11.7	
Green Ext Time (p_c), s	0.0	14.9		0.0	12.9		0.0	6.9		0.0	7.0	
Intersection Summary												
HCM 2010 Ctrl Delay			25.0									
HCM 2010 LOS			C									
Notes												

























HCM 2010 Signalized Intersection Summary
 12: Unser Blvd & Paseo del Norte

Scheme C -- Year 2035 PM
 6/1/2013

												
Movement	SEL	SET	SER	NWL	NWT	NWR	NEL	NET	NER	SWL	SWT	SWR
Lane Configurations												
Volume (veh/h)	100	1900	109	150	2411	100	150	905	200	150	792	150
Number	7	4	14	3	8	18	5	2	12	1	6	16
Initial Q (Qb), veh	0	0	0	0	0	0	0	0	0	0	0	0
Ped-Bike Adj(A_pbT)	1.00		0.98	1.00		0.98	0.99		0.97	1.00		0.97
Parking Bus Adj	1.00	1.00	1.00	1.00	1.00	1.00	1.00	1.00	1.00	1.00	1.00	1.00
Adj Sat Flow veh/h/ln	186.3	186.3	186.3	186.3	186.3	186.3	186.3	186.3	186.3	186.3	186.3	186.3
Lanes	2	3	1	2	3	1	2	2	1	2	2	1
Cap, veh/h	155	2222	615	210	2311	715	498	1184	585	386	1183	560
Arrive On Green	0.05	0.40	0.40	0.06	0.41	0.41	0.05	0.32	0.32	0.09	0.64	0.64
Sat Flow, veh/h	3442	5588	1547	3442	5588	1549	3442	3725	1538	3442	3725	1538
Grp Volume(v), veh/h	100	1900	109	150	2411	100	150	905	200	150	792	150
Grp Sat Flow(s),veh/h/ln	1721	1863	1547	1721	1863	1549	1721	1863	1538	1721	1863	1538
Q Serve(g_s), s	3.2	35.1	5.2	4.8	46.8	4.2	3.3	24.8	10.5	3.3	15.3	4.7
Cycle Q Clear(g_c), s	3.2	35.1	5.2	4.8	46.8	4.2	3.3	24.8	10.5	3.3	15.3	4.7
Prop In Lane	1.00		1.00	1.00		1.00	1.00		1.00	1.00		1.00
Lane Grp Cap(c), veh/h	155	2222	615	210	2311	715	498	1184	585	386	1183	560
V/C Ratio(X)	0.65	0.86	0.18	0.72	1.04	0.14	0.30	0.76	0.34	0.39	0.67	0.27
Avail Cap(c_a), veh/h	304	2222	615	304	2311	715	579	1218	599	468	1218	574
HCM Platoon Ratio	1.00	1.00	1.00	1.00	1.00	1.00	1.00	1.00	1.00	2.00	2.00	2.00
Upstream Filter(I)	0.61	0.61	0.61	0.09	0.09	0.09	0.72	0.72	0.72	0.92	0.92	0.92
Uniform Delay (d), s/veh	53.2	31.1	22.1	52.2	33.2	17.6	25.1	34.8	25.1	25.7	16.9	13.1
Incr Delay (d2), s/veh	2.7	2.8	0.4	0.4	21.1	0.0	0.2	2.1	0.2	0.6	1.3	0.2
Initial Q Delay(d3),s/veh	0.0	0.0	0.0	0.0	0.0	0.0	0.0	0.0	0.0	0.0	0.0	0.0
%ile Back of Q (50%), veh/ln	1.5	16.4	2.0	2.1	25.5	1.5	1.4	11.8	3.9	1.3	4.7	1.5
Lane Grp Delay (d), s/veh	55.9	33.9	22.5	52.6	54.3	17.6	25.3	36.9	25.4	26.3	18.1	13.3
Lane Grp LOS	E	C	C	D	F	B	C	D	C	C	B	B
Approach Vol, veh/h		2109			2661			1255			1092	
Approach Delay, s/veh		34.4			52.8			33.7			18.6	
Approach LOS		C			D			C			B	
Timer												
Assigned Phs	7	4		3	8		5	2		1	6	
Phs Duration (G+Y+Rc), s	10.1	50.0		11.9	51.8		10.3	41.0		10.3	41.0	
Change Period (Y+Rc), s	5.0	5.0		5.0	5.0		5.0	5.0		5.0	5.0	
Max Green Setting (Gmax), s	10.0	45.0		10.0	45.0		8.0	37.0		8.0	37.0	
Max Q Clear Time (g_c+I1), s	5.2	37.1		6.8	48.8		5.3	26.8		5.3	17.3	
Green Ext Time (p_c), s	0.1	7.8		0.1	0.0		0.1	7.5		0.1	12.2	
Intersection Summary												
HCM 2010 Ctrl Delay			38.7									
HCM 2010 LOS			D									
Notes												







HCM 2010 Signalized Intersection Summary
 13: Kimmick Rd & Paseo del Norte

Scheme C -- Year 2035 PM
 6/1/2013

												
Movement	EBL	EBT	EBR	WBL	WBT	WBR	NBL	NBT	NBR	SBL	SBT	SBR
Lane Configurations												
Volume (veh/h)	177	1968	100	200	2456	286	141	150	193	150	150	172
Number	7	4	14	3	8	18	5	2	12	1	6	16
Initial Q (Qb), veh	0	0	0	0	0	0	0	0	0	0	0	0
Ped-Bike Adj(A_pbT)	1.00		0.99	1.00		0.99	0.99		0.98	0.99		0.98
Parking Bus Adj	1.00	1.00	1.00	1.00	1.00	1.00	1.00	1.00	1.00	1.00	1.00	1.00
Adj Sat Flow veh/h/ln	186.3	186.3	186.3	186.3	186.3	193.7	186.3	186.3	186.3	186.3	186.3	186.3
Lanes	2	3	1	2	3	1	1	1	1	2	1	1
Cap, veh/h	243	2469	692	266	2506	731	348	440	367	654	412	343
Arrive On Green	0.07	0.44	0.44	0.08	0.45	0.45	0.07	0.24	0.24	0.05	0.22	0.22
Sat Flow, veh/h	3442	5588	1567	3442	5588	1630	1774	1863	1553	3442	1863	1551
Grp Volume(v), veh/h	177	1968	100	200	2456	286	141	150	193	150	150	172
Grp Sat Flow(s),veh/h/ln	1721	1863	1567	1721	1863	1630	1774	1863	1553	1721	1863	1551
Q Serve(g_s), s	5.2	31.5	4.0	5.9	44.9	12.2	6.2	6.9	11.3	3.4	7.1	10.1
Cycle Q Clear(g_c), s	5.2	31.5	4.0	5.9	44.9	12.2	6.2	6.9	11.3	3.4	7.1	10.1
Prop In Lane	1.00		1.00	1.00		1.00	1.00		1.00	1.00		1.00
Lane Grp Cap(c), veh/h	243	2469	692	266	2506	731	348	440	367	654	412	343
V/C Ratio(X)	0.73	0.80	0.14	0.75	0.98	0.39	0.40	0.34	0.53	0.23	0.36	0.50
Avail Cap(c_a), veh/h	331	2475	694	331	2506	731	348	664	553	706	664	553
HCM Platoon Ratio	1.00	1.00	1.00	1.00	1.00	1.00	1.00	1.00	1.00	1.00	1.00	1.00
Upstream Filter(I)	1.00	1.00	1.00	1.00	1.00	1.00	1.00	1.00	1.00	1.00	1.00	1.00
Uniform Delay (d), s/veh	47.3	25.0	17.3	47.0	28.2	19.2	27.8	33.0	34.6	28.8	34.3	35.4
Incr Delay (d2), s/veh	5.2	2.8	0.4	7.3	13.9	1.6	0.8	0.5	1.2	0.2	0.5	1.1
Initial Q Delay(d3),s/veh	0.0	0.0	0.0	0.0	0.0	0.0	0.0	0.0	0.0	0.0	0.0	0.0
%ile Back of Q (50%), veh/ln	2.4	14.3	0.1	2.8	23.0	5.0	2.8	3.3	4.4	1.5	3.4	3.9
Lane Grp Delay (d), s/veh	52.5	27.8	17.7	54.3	42.1	20.7	28.5	33.4	35.8	29.0	34.8	36.6
Lane Grp LOS	D	C	B	D	D	C	C	C	D	C	C	D
Approach Vol, veh/h		2245			2942			484			472	
Approach Delay, s/veh		29.3			40.8			32.9			33.6	
Approach LOS		C			D			C			C	
Timer												
Assigned Phs	7	4		3	8		5	2		1	6	
Phs Duration (G+Y+Rc), s	12.3	50.9		13.0	51.6		12.0	29.5		10.4	28.0	
Change Period (Y+Rc), s	5.0	5.0		5.0	5.0		5.0	5.0		5.0	5.0	
Max Green Setting (Gmax), s	10.0	46.0		10.0	46.0		7.0	37.0		7.0	37.0	
Max Q Clear Time (g_c+I1), s	7.2	33.5		7.9	46.9		8.2	13.3		5.4	12.1	
Green Ext Time (p_c), s	0.1	12.4		0.1	0.0		0.0	3.1		0.1	3.1	
Intersection Summary												
HCM 2010 Ctrl Delay			35.4									
HCM 2010 LOS			D									
Notes												

























HCM 2010 Signalized Intersection Summary
 14: Transit Blvd & Unser Blvd

Scheme C -- Year 2035 PM
 6/1/2013

						
Movement	EBT	EBR	WBL	WBT	NBL	NBR
Lane Configurations	↑↑	↑	↑↑	↑↑	↑	↑
Volume (veh/h)	899	125	182	810	175	459
Number	4	14	3	8	5	12
Initial Q (Qb), veh	0	0	0	0	0	0
Ped-Bike Adj(A_pbT)		0.98	1.00		1.00	1.00
Parking Bus Adj	1.00	1.00	1.00	1.00	1.00	1.00
Adj Sat Flow veh/h/ln	186.3	186.3	186.3	186.3	186.3	186.3
Lanes	2	1	2	2	1	1
Cap, veh/h	1693	708	252	2134	596	532
Arrive On Green	0.45	0.45	0.07	0.57	0.34	0.34
Sat Flow, veh/h	3725	1557	3442	3725	1774	1583
Grp Volume(v), veh/h	899	125	182	810	175	459
Grp Sat Flow(s),veh/h/ln	1863	1557	1721	1863	1774	1583
Q Serve(g_s), s	19.1	5.2	5.7	13.1	8.0	29.8
Cycle Q Clear(g_c), s	19.1	5.2	5.7	13.1	8.0	29.8
Prop In Lane		1.00	1.00		1.00	1.00
Lane Grp Cap(c), veh/h	1693	708	252	2134	596	532
V/C Ratio(X)	0.53	0.18	0.72	0.38	0.29	0.86
Avail Cap(c_a), veh/h	1693	708	563	2134	596	532
HCM Platoon Ratio	1.00	1.00	1.00	1.00	1.00	1.00
Upstream Filter(I)	1.00	1.00	1.00	1.00	1.00	1.00
Uniform Delay (d), s/veh	21.6	17.8	49.9	12.8	26.9	34.1
Incr Delay (d2), s/veh	1.2	0.5	3.9	0.1	1.2	16.7
Initial Q Delay(d3),s/veh	0.0	0.0	0.0	0.0	0.0	0.0
%ile Back of Q (50%), veh/ln	8.8	2.1	2.6	5.4	3.8	13.9
Lane Grp Delay (d), s/veh	22.8	18.4	53.8	12.9	28.1	50.8
Lane Grp LOS	C	B	D	B	C	D
Approach Vol, veh/h	1024			992	634	
Approach Delay, s/veh	22.2			20.4	44.6	
Approach LOS	C			C	D	
Timer						
Assigned Phs	4		3	8		
Phs Duration (G+Y+Rc), s	55.0		13.0	68.0		
Change Period (Y+Rc), s	5.0		5.0	5.0		
Max Green Setting (Gmax), s	50.0		18.0	50.0		
Max Q Clear Time (g_c+I1), s	21.1		7.7	15.1		
Green Ext Time (p_c), s	14.2		0.4	15.5		
Intersection Summary						
HCM 2010 Ctrl Delay			26.9			
HCM 2010 LOS			C			
Notes						

























HCM 2010 Signalized Intersection Summary
 101: Paseo del Norte & Loop Rd W/Loop Rd N

Scheme C -- Year 2035 PM
 6/1/2013

												
Movement	EBL	EBT	EBR	WBL	WBT	WBR	SEL	SET	SER	NWL	NWT	NWR
Lane Configurations												
Volume (veh/h)	114	100	246	133	100	137	131	1730	172	262	2200	250
Number	5	2	12	1	6	16	7	4	14	3	8	18
Initial Q (Qb), veh	0	0	0	0	0	0	0	0	0	0	0	0
Ped-Bike Adj(A_pbT)	1.00		1.00	1.00		1.00	1.00		1.00	1.00		1.00
Parking Bus Adj	1.00	1.00	1.00	1.00	1.00	1.00	1.00	1.00	1.00	1.00	1.00	1.00
Adj Sat Flow veh/h/ln	186.3	186.3	186.3	186.3	186.3	186.3	186.3	186.3	193.7	186.3	186.3	193.7
Lanes	1	1	1	1	1	1	1	3	1	1	3	1
Cap, veh/h	262	401	341	244	401	341	159	3012	888	185	3091	911
Arrive On Green	0.22	0.22	0.22	0.22	0.22	0.22	0.09	0.54	0.54	0.21	1.00	1.00
Sat Flow, veh/h	1139	1863	1583	1031	1863	1583	1774	5588	1647	1774	5588	1647
Grp Volume(v), veh/h	114	100	246	133	100	137	131	1730	172	262	2200	250
Grp Sat Flow(s),veh/h/ln	1139	1863	1583	1031	1863	1583	1774	1863	1647	1774	1863	1647
Q Serve(g_s), s	9.8	4.7	15.3	13.0	4.7	7.9	7.7	21.9	5.7	11.0	0.0	0.0
Cycle Q Clear(g_c), s	14.5	4.7	15.3	17.7	4.7	7.9	7.7	21.9	5.7	11.0	0.0	0.0
Prop In Lane	1.00		1.00	1.00		1.00	1.00		1.00	1.00		1.00
Lane Grp Cap(c), veh/h	262	401	341	244	401	341	159	3012	888	185	3091	911
V/C Ratio(X)	0.43	0.25	0.72	0.55	0.25	0.40	0.82	0.57	0.19	1.42	0.71	0.27
Avail Cap(c_a), veh/h	416	652	554	383	652	554	185	3012	888	185	3091	911
HCM Platoon Ratio	1.00	1.00	1.00	1.00	1.00	1.00	1.00	1.00	1.00	2.00	2.00	2.00
Upstream Filter(I)	1.00	1.00	1.00	1.00	1.00	1.00	0.63	0.63	0.63	0.09	0.09	0.09
Uniform Delay (d), s/veh	40.4	34.4	38.6	41.8	34.4	35.7	47.3	16.3	12.5	41.9	0.0	0.0
Incr Delay (d2), s/veh	1.1	0.3	2.9	1.9	0.3	0.8	15.0	0.5	0.3	191.8	0.1	0.1
Initial Q Delay(d3),s/veh	0.0	0.0	0.0	0.0	0.0	0.0	0.0	0.0	0.0	0.0	0.0	0.0
%ile Back of Q (50%), veh/ln	2.9	2.3	6.2	3.6	2.3	3.2	4.1	9.3	2.2	14.1	0.0	0.0
Lane Grp Delay (d), s/veh	41.6	34.7	41.5	43.7	34.7	36.4	62.3	16.8	12.9	233.7	0.1	0.1
Lane Grp LOS	D	C	D	D	C	D	E	B	B	F	A	A
Approach Vol, veh/h		460			370			2033			2712	
Approach Delay, s/veh		40.0			38.6			19.4			22.7	
Approach LOS		D			D			B			C	
Timer												
Assigned Phs		2			6		7	4		3		8
Phs Duration (G+Y+Rc), s		27.8			27.8		14.5	62.0		16.0		63.5
Change Period (Y+Rc), s		5.0			5.0		5.0	5.0		5.0		5.0
Max Green Setting (Gmax), s		37.0			37.0		11.0	57.0		11.0		57.0
Max Q Clear Time (g_c+I1), s		17.3			19.7		9.7	23.9		13.0		2.0
Green Ext Time (p_c), s		3.1			3.0		0.0	31.7		0.0		51.2
Intersection Summary												
HCM 2010 Ctrl Delay			24.0									
HCM 2010 LOS			C									
Notes												





























HCM 2010 Signalized Intersection Summary
 102: Unser Blvd & Loop Rd N

Scheme C -- Year 2035 PM
 6/1/2013

												
Movement	SEL	SET	SER	NWL	NWT	NWR	NEL	NET	NER	SWL	SWT	SWR
Lane Configurations												
Volume (veh/h)	100	100	150	150	100	150	131	775	200	100	791	63
Number	1	6	16	5	2	12	7	4	14	3	8	18
Initial Q (Qb), veh	0	0	0	0	0	0	0	0	0	0	0	0
Ped-Bike Adj(A_pbT)	1.00		1.00	1.00		1.00	1.00		1.00	1.00		1.00
Parking Bus Adj	1.00	1.00	1.00	1.00	1.00	1.00	1.00	1.00	1.00	1.00	1.00	1.00
Adj Sat Flow veh/h/ln	186.3	186.3	186.3	186.3	186.3	186.3	186.3	186.3	186.3	186.3	186.3	186.3
Lanes	1	1	1	1	1	1	1	2	1	1	2	1
Cap, veh/h	261	403	343	261	403	343	458	2568	1091	417	2568	1091
Arrive On Green	0.22	0.22	0.22	0.22	0.22	0.22	0.69	0.69	0.69	0.69	0.69	0.69
Sat Flow, veh/h	1125	1863	1583	1125	1863	1583	644	3725	1583	574	3725	1583
Grp Volume(v), veh/h	100	100	150	150	100	150	131	775	200	100	791	63
Grp Sat Flow(s),veh/h/ln	1125	1863	1583	1125	1863	1583	644	1863	1583	574	1863	1583
Q Serve(g_s), s	8.6	4.7	8.7	13.5	4.7	8.7	10.7	8.6	4.8	8.8	8.9	1.4
Cycle Q Clear(g_c), s	13.3	4.7	8.7	18.2	4.7	8.7	19.6	8.6	4.8	17.4	8.9	1.4
Prop In Lane	1.00		1.00	1.00		1.00	1.00		1.00	1.00		1.00
Lane Grp Cap(c), veh/h	261	403	343	261	403	343	458	2568	1091	417	2568	1091
V/C Ratio(X)	0.38	0.25	0.44	0.57	0.25	0.44	0.29	0.30	0.18	0.24	0.31	0.06
Avail Cap(c_a), veh/h	411	651	553	411	651	553	458	2568	1091	417	2568	1091
HCM Platoon Ratio	1.00	1.00	1.00	1.00	1.00	1.00	1.00	1.00	1.00	1.00	1.00	1.00
Upstream Filter(I)	1.00	1.00	1.00	0.99	0.99	0.99	0.53	0.53	0.53	1.00	1.00	1.00
Uniform Delay (d), s/veh	39.9	34.4	35.9	41.9	34.4	35.9	10.4	6.5	5.9	9.9	6.5	5.3
Incr Delay (d2), s/veh	0.9	0.3	0.9	2.0	0.3	0.9	0.8	0.2	0.2	1.4	0.3	0.1
Initial Q Delay(d3),s/veh	0.0	0.0	0.0	0.0	0.0	0.0	0.0	0.0	0.0	0.0	0.0	0.0
%ile Back of Q (50%), veh/ln	2.5	2.3	3.5	4.0	2.3	3.5	1.6	3.3	1.6	1.2	3.4	0.5
Lane Grp Delay (d), s/veh	40.8	34.7	36.8	43.9	34.7	36.8	11.2	6.6	6.1	11.2	6.8	5.4
Lane Grp LOS	D	C	D	D	C	D	B	A	A	B	A	A
Approach Vol, veh/h		350			400			1106			954	
Approach Delay, s/veh		37.3			38.9			7.1			7.2	
Approach LOS		D			D			A			A	
Timer												
Assigned Phs		6			2			4			8	
Phs Duration (G+Y+Rc), s		27.9			27.9			78.0			78.0	
Change Period (Y+Rc), s		5.0			5.0			5.0			5.0	
Max Green Setting (Gmax), s		37.0			37.0			73.0			73.0	
Max Q Clear Time (g_c+I1), s		15.3			20.2			21.6			19.4	
Green Ext Time (p_c), s		2.9			2.7			18.4			18.6	
Intersection Summary												
HCM 2010 Ctrl Delay			15.4									
HCM 2010 LOS			B									
Notes												

























HCM 2010 Signalized Intersection Summary
 103: Avenida de Jaimito/Transit Blvd & Paseo del Norte

Scheme C -- Year 2035 PM
 6/1/2013

												
Movement	SEL	SET	SER	NWL	NWT	NWR	NEL	NET	NER	SWL	SWT	SWR
Lane Configurations		  			  							
Volume (veh/h)	200	1800	250	262	2233	343	135	100	272	178	100	293
Number	7	4	14	3	8	18	5	2	12	1	6	16
Initial Q (Qb), veh	0	0	0	0	0	0	0	0	0	0	0	0
Ped-Bike Adj(A_pbT)	1.00		1.00	1.00		1.00	1.00		1.00	1.00		1.00
Parking Bus Adj	1.00	1.00	1.00	1.00	1.00	1.00	1.00	1.00	1.00	1.00	1.00	1.00
Adj Sat Flow veh/h/ln	167.6	167.6	174.4	167.6	167.6	174.4	167.6	167.6	167.6	167.6	167.6	167.6
Lanes	1	3	1	1	3	1	1	1	1	1	1	1
Cap, veh/h	181	2412	711	181	2412	711	267	463	394	271	463	394
Arrive On Green	0.11	0.48	0.48	0.11	0.48	0.48	0.28	0.28	0.28	0.28	0.28	0.28
Sat Flow, veh/h	1597	5029	1482	1597	5029	1482	888	1676	1425	906	1676	1425
Grp Volume(v), veh/h	200	1800	250	262	2233	343	135	100	272	178	100	293
Grp Sat Flow(s),veh/h/ln	1597	1676	1482	1597	1676	1482	888	1676	1425	906	1676	1425
Q Serve(g_s), s	13.0	33.3	12.1	13.0	47.7	18.0	15.8	5.3	19.6	21.6	5.3	21.5
Cycle Q Clear(g_c), s	13.0	33.3	12.1	13.0	47.7	18.0	21.1	5.3	19.6	26.9	5.3	21.5
Prop In Lane	1.00		1.00	1.00		1.00	1.00		1.00	1.00		1.00
Lane Grp Cap(c), veh/h	181	2412	711	181	2412	711	267	463	394	271	463	394
V/C Ratio(X)	1.11	0.75	0.35	1.45	0.93	0.48	0.50	0.22	0.69	0.66	0.22	0.74
Avail Cap(c_a), veh/h	181	2412	711	181	2412	711	309	541	460	313	541	460
HCM Platoon Ratio	1.00	1.00	1.00	1.00	1.00	1.00	1.00	1.00	1.00	1.00	1.00	1.00
Upstream Filter(I)	0.33	0.33	0.33	1.00	1.00	1.00	1.00	1.00	1.00	1.00	1.00	1.00
Uniform Delay (d), s/veh	50.8	24.2	18.7	50.8	27.9	20.2	40.0	31.9	37.1	42.3	31.9	37.8
Incr Delay (d2), s/veh	70.7	0.7	0.5	229.7	7.6	2.3	1.5	0.2	3.6	4.0	0.2	5.5
Initial Q Delay(d3),s/veh	0.0	0.0	0.0	0.0	0.0	0.0	0.0	0.0	0.0	0.0	0.0	0.0
%ile Back of Q (50%), veh/ln	8.8	13.3	4.3	16.8	20.5	6.8	3.7	2.3	7.3	5.3	2.3	8.2
Lane Grp Delay (d), s/veh	121.6	24.9	19.1	280.5	35.5	22.6	41.5	32.2	40.7	46.2	32.2	43.3
Lane Grp LOS	F	C	B	F	D	C	D	C	D	D	C	D
Approach Vol, veh/h		2250			2838			507			571	
Approach Delay, s/veh		32.9			56.6			39.2			42.3	
Approach LOS		C			E			D			D	
Timer												
Assigned Phs	7	4		3	8			2			6	
Phs Duration (G+Y+Rc), s	18.0	60.0		18.0	60.0			36.7			36.7	
Change Period (Y+Rc), s	5.0	5.0		5.0	5.0			5.0			5.0	
Max Green Setting (Gmax), s	13.0	55.0		13.0	55.0			37.0			37.0	
Max Q Clear Time (g_c+I1), s	15.0	35.3		15.0	49.7			23.1			28.9	
Green Ext Time (p_c), s	0.0	19.3		0.0	5.3			3.7			2.8	
Intersection Summary												
HCM 2010 Ctrl Delay			45.2									
HCM 2010 LOS			D									
Notes												

HCM 2010 Signalized Intersection Summary
 104: Unser Blvd & Loop Rd W/Avenida de Jaimito

Scheme C -- Year 2035 PM
 6/1/2013

												
Movement	EBL	EBT	EBR	WBL	WBT	WBR	NBL	NBT	NBR	SBL	SBT	SBR
Lane Configurations												
Volume (veh/h)	50	100	180	180	100	100	121	1105	202	50	800	200
Number	7	4	14	3	8	18	5	2	12	1	6	16
Initial Q (Qb), veh	0	0	0	0	0	0	0	0	0	0	0	0
Ped-Bike Adj(A_pbT)	1.00		1.00	1.00		1.00	1.00		1.00	1.00		1.00
Parking Bus Adj	1.00	1.00	1.00	1.00	1.00	1.00	1.00	1.00	1.00	1.00	1.00	1.00
Adj Sat Flow veh/h/ln	186.3	186.3	186.3	186.3	186.3	186.3	186.3	186.3	186.3	186.3	186.3	186.3
Lanes	1	1	1	1	1	1	1	2	1	1	2	1
Cap, veh/h	435	639	544	410	639	544	316	2059	875	228	2059	875
Arrive On Green	0.34	0.34	0.34	0.34	0.34	0.34	0.55	0.55	0.55	0.55	0.55	0.55
Sat Flow, veh/h	1178	1863	1583	1095	1863	1583	561	3725	1583	419	3725	1583
Grp Volume(v), veh/h	50	100	180	180	100	100	121	1105	202	50	800	200
Grp Sat Flow(s),veh/h/ln	1178	1863	1583	1095	1863	1583	561	1863	1583	419	1863	1583
Q Serve(g_s), s	3.0	3.6	8.1	13.1	3.6	4.3	15.1	18.1	6.3	8.3	11.8	6.2
Cycle Q Clear(g_c), s	6.5	3.6	8.1	16.7	3.6	4.3	26.8	18.1	6.3	26.4	11.8	6.2
Prop In Lane	1.00		1.00	1.00		1.00	1.00		1.00	1.00		1.00
Lane Grp Cap(c), veh/h	435	639	544	410	639	544	316	2059	875	228	2059	875
V/C Ratio(X)	0.11	0.16	0.33	0.44	0.16	0.18	0.38	0.54	0.23	0.22	0.39	0.23
Avail Cap(c_a), veh/h	435	639	544	410	639	544	456	2984	1268	332	2984	1268
HCM Platoon Ratio	1.00	1.00	1.00	1.00	1.00	1.00	1.00	1.00	1.00	1.00	1.00	1.00
Upstream Filter(I)	1.00	1.00	1.00	1.00	1.00	1.00	0.46	0.46	0.46	0.66	0.66	0.66
Uniform Delay (d), s/veh	24.2	21.9	23.4	27.7	21.9	22.1	19.9	13.7	11.0	22.1	12.2	11.0
Incr Delay (d2), s/veh	0.5	0.5	1.6	3.4	0.5	0.7	0.4	0.1	0.1	0.3	0.1	0.1
Initial Q Delay(d3),s/veh	0.0	0.0	0.0	0.0	0.0	0.0	0.0	0.0	0.0	0.0	0.0	0.0
%ile Back of Q (50%), veh/ln	0.9	1.8	3.4	3.9	1.8	1.8	2.0	7.4	2.1	0.9	4.8	2.1
Lane Grp Delay (d), s/veh	24.7	22.4	25.0	31.1	22.4	22.9	20.2	13.8	11.1	22.4	12.3	11.1
Lane Grp LOS	C	C	C	C	C	C	C	B	B	C	B	B
Approach Vol, veh/h		330			380			1428			1050	
Approach Delay, s/veh		24.2			26.6			13.9			12.6	
Approach LOS		C			C			B			B	
Timer												
Assigned Phs		4			8			2			6	
Phs Duration (G+Y+Rc), s		38.0			38.0			58.1			58.1	
Change Period (Y+Rc), s		5.0			5.0			5.0			5.0	
Max Green Setting (Gmax), s		33.0			33.0			77.0			77.0	
Max Q Clear Time (g_c+I1), s		10.1			18.7			28.8			28.4	
Green Ext Time (p_c), s		2.8			2.5			24.3			24.4	
Intersection Summary												
HCM 2010 Ctrl Delay				16.1								
HCM 2010 LOS				B								
Notes												

Paseo del Norte

























Direction	EB	WB	All
Average Speed (mph)	24	20	22
Total Travel Time (hr)	235	305	539
Distance Traveled (mi)	5631	6070	11701
Performance Index	130.2	198.6	328.8

Unser Blvd

Direction	EB	NB	SW	All
Average Speed (mph)	24	23	21	22
Total Travel Time (hr)	11	58	65	134
Distance Traveled (mi)	267	1301	1392	2960
Performance Index	6.7	37.2	43.1	87.0

























HCM 2010 Signalized Intersection Summary
 11: Universe & Paseo del Norte

Scheme D -- Year 2035 PM
 6/6/2013

												
Movement	EBL	EBT	EBR	WBL	WBT	WBR	NBL	NBT	NBR	SBL	SBT	SBR
Lane Configurations												
Volume (veh/h)	150	1832	54	100	2101	250	104	500	50	150	400	150
Number	7	4	14	3	8	18	5	2	12	1	6	16
Initial Q (Qb), veh	0	0	0	0	0	0	0	0	0	0	0	0
Ped-Bike Adj(A_pbT)	1.00		1.00	1.00		1.00	1.00		1.00	1.00		1.00
Parking Bus Adj	1.00	1.00	1.00	1.00	1.00	1.00	1.00	1.00	1.00	1.00	1.00	1.00
Adj Sat Flow veh/h/ln	186.3	186.3	186.3	186.3	186.3	186.3	186.3	186.3	186.3	186.3	186.3	186.3
Lanes	2	3	1	2	3	1	2	2	1	2	2	1
Cap, veh/h	212	2847	807	157	2730	774	160	736	313	212	792	337
Arrive On Green	0.06	0.51	0.51	0.05	0.49	0.49	0.09	0.39	0.39	0.06	0.21	0.21
Sat Flow, veh/h	3442	5588	1583	3442	5588	1583	3442	3725	1583	3442	3725	1583
Grp Volume(v), veh/h	150	1832	54	100	2101	250	104	500	50	150	400	150
Grp Sat Flow(s),veh/h/ln	1721	1863	1583	1721	1863	1583	1721	1863	1583	1721	1863	1583
Q Serve(g_s), s	4.4	24.5	1.8	2.9	31.5	6.8	3.0	11.4	2.1	4.4	9.7	6.7
Cycle Q Clear(g_c), s	4.4	24.5	1.8	2.9	31.5	6.8	3.0	11.4	2.1	4.4	9.7	6.7
Prop In Lane	1.00		1.00	1.00		1.00	1.00		1.00	1.00		1.00
Lane Grp Cap(c), veh/h	212	2847	807	157	2730	774	160	736	313	212	792	337
V/C Ratio(X)	0.71	0.64	0.07	0.64	0.77	0.32	0.65	0.68	0.16	0.71	0.51	0.45
Avail Cap(c_a), veh/h	235	2847	807	235	2730	774	235	1347	572	235	1347	572
HCM Platoon Ratio	1.00	1.00	1.00	1.00	1.00	1.00	2.00	2.00	2.00	1.00	1.00	1.00
Upstream Filter(I)	1.00	1.00	1.00	0.65	0.65	0.65	1.00	1.00	1.00	1.00	1.00	1.00
Uniform Delay (d), s/veh	47.1	18.3	12.7	48.0	21.4	7.7	45.6	28.3	25.5	47.1	35.5	22.3
Incr Delay (d2), s/veh	8.3	0.5	0.0	2.8	1.4	0.7	4.4	1.1	0.2	8.3	0.5	0.9
Initial Q Delay(d3),s/veh	0.0	0.0	0.0	0.0	0.0	0.0	0.0	0.0	0.0	0.0	0.0	0.0
%ile Back of Q (50%), veh/ln	2.2	10.6	0.6	1.3	14.0	2.4	1.3	4.4	0.8	2.2	4.5	2.6
Lane Grp Delay (d), s/veh	55.4	18.8	12.8	50.8	22.9	8.5	49.9	29.4	25.7	55.4	36.0	23.2
Lane Grp LOS	E	B	B	D	C	A	D	C	C	E	D	C
Approach Vol, veh/h		2036			2451			654			700	
Approach Delay, s/veh		21.4			22.5			32.4			37.4	
Approach LOS		C			C			C			D	
Timer												
Assigned Phs	7	4		3	8		5	2		1	6	
Phs Duration (G+Y+Rc), s	11.3	57.1		9.2	55.0		9.3	25.2		10.8	26.8	
Change Period (Y+Rc), s	5.0	5.0		4.5	5.0		4.5	5.0		4.5	5.0	
Max Green Setting (Gmax), s	7.0	50.0		7.0	50.0		7.0	37.0		7.0	37.0	
Max Q Clear Time (g_c+I1), s	6.4	26.5		4.9	33.5		5.0	13.4		6.4	11.7	
Green Ext Time (p_c), s	0.0	14.9		0.0	12.9		0.0	6.9		0.0	7.0	
Intersection Summary												
HCM 2010 Ctrl Delay			25.0									
HCM 2010 LOS			C									
Notes												

























HCM 2010 Signalized Intersection Summary
 12: Unser Blvd & Paseo del Norte

Scheme D -- Year 2035 PM
 6/6/2013







												
Movement	SEL	SET	SER	NWL	NWT	NWR	NEL	NET	NER	SWL	SWT	SWR
Lane Configurations												
Volume (veh/h)	100	1900	109	150	2411	100	150	905	200	150	792	150
Number	7	4	14	3	8	18	5	2	12	1	6	16
Initial Q (Qb), veh	0	0	0	0	0	0	0	0	0	0	0	0
Ped-Bike Adj(A_pbT)	1.00		0.98	1.00		0.98	0.99		0.97	1.00		0.97
Parking Bus Adj	1.00	1.00	1.00	1.00	1.00	1.00	1.00	1.00	1.00	1.00	1.00	1.00
Adj Sat Flow veh/h/ln	186.3	186.3	186.3	186.3	186.3	186.3	186.3	186.3	186.3	186.3	186.3	186.3
Lanes	2	3	1	2	3	1	2	2	1	2	2	1
Cap, veh/h	155	2222	615	210	2311	715	498	1184	585	386	1183	560
Arrive On Green	0.05	0.40	0.40	0.06	0.41	0.41	0.05	0.32	0.32	0.09	0.64	0.64
Sat Flow, veh/h	3442	5588	1547	3442	5588	1549	3442	3725	1538	3442	3725	1538
Grp Volume(v), veh/h	100	1900	109	150	2411	100	150	905	200	150	792	150
Grp Sat Flow(s),veh/h/ln	1721	1863	1547	1721	1863	1549	1721	1863	1538	1721	1863	1538
Q Serve(g_s), s	3.2	35.1	5.2	4.8	46.8	4.2	3.3	24.8	10.5	3.3	15.3	4.7
Cycle Q Clear(g_c), s	3.2	35.1	5.2	4.8	46.8	4.2	3.3	24.8	10.5	3.3	15.3	4.7
Prop In Lane	1.00		1.00	1.00		1.00	1.00		1.00	1.00		1.00
Lane Grp Cap(c), veh/h	155	2222	615	210	2311	715	498	1184	585	386	1183	560
V/C Ratio(X)	0.65	0.86	0.18	0.72	1.04	0.14	0.30	0.76	0.34	0.39	0.67	0.27
Avail Cap(c_a), veh/h	304	2222	615	304	2311	715	579	1218	599	468	1218	574
HCM Platoon Ratio	1.00	1.00	1.00	1.00	1.00	1.00	1.00	1.00	1.00	2.00	2.00	2.00
Upstream Filter(I)	0.62	0.62	0.62	0.44	0.44	0.44	0.72	0.72	0.72	0.92	0.92	0.92
Uniform Delay (d), s/veh	53.2	31.1	22.1	52.2	33.2	17.6	25.1	34.8	25.1	25.7	16.9	13.1
Incr Delay (d2), s/veh	2.8	2.9	0.4	2.0	25.7	0.2	0.2	2.1	0.2	0.6	1.3	0.2
Initial Q Delay(d3),s/veh	0.0	0.0	0.0	0.0	0.0	0.0	0.0	0.0	0.0	0.0	0.0	0.0
%ile Back of Q (50%), veh/ln	1.5	16.4	2.0	2.2	26.5	1.5	1.4	11.8	3.9	1.3	4.7	1.5
Lane Grp Delay (d), s/veh	55.9	34.0	22.5	54.2	58.9	17.8	25.3	36.9	25.4	26.3	18.1	13.3
Lane Grp LOS	E	C	C	D	F	B	C	D	C	C	B	B
Approach Vol, veh/h		2109			2661			1255			1092	
Approach Delay, s/veh		34.4			57.1			33.7			18.6	
Approach LOS		C			E			C			B	
Timer												
Assigned Phs	7	4		3	8		5	2		1	6	
Phs Duration (G+Y+Rc), s	10.1	50.0		11.9	51.8		10.3	41.0		10.3	41.0	
Change Period (Y+Rc), s	5.0	5.0		5.0	5.0		5.0	5.0		5.0	5.0	
Max Green Setting (Gmax), s	10.0	45.0		10.0	45.0		8.0	37.0		8.0	37.0	
Max Q Clear Time (g_c+I1), s	5.2	37.1		6.8	48.8		5.3	26.8		5.3	17.3	
Green Ext Time (p_c), s	0.1	7.8		0.1	0.0		0.1	7.5		0.1	12.2	
Intersection Summary												
HCM 2010 Ctrl Delay			40.3									
HCM 2010 LOS			D									
Notes												

HCM 2010 Signalized Intersection Summary
 13: Kimmick Rd & Paseo del Norte

Scheme D -- Year 2035 PM
 6/6/2013

























												
Movement	EBL	EBT	EBR	WBL	WBT	WBR	NBL	NBT	NBR	SBL	SBT	SBR
Lane Configurations												
Volume (veh/h)	132	2018	100	200	2456	243	141	150	193	100	150	172
Number	7	4	14	3	8	18	5	2	12	1	6	16
Initial Q (Qb), veh	0	0	0	0	0	0	0	0	0	0	0	0
Ped-Bike Adj(A_pbT)	1.00		0.99	1.00		0.99	0.99		0.98	0.99		0.98
Parking Bus Adj	1.00	1.00	1.00	1.00	1.00	1.00	1.00	1.00	1.00	1.00	1.00	1.00
Adj Sat Flow veh/h/ln	186.3	186.3	186.3	186.3	186.3	193.7	186.3	186.3	186.3	186.3	186.3	186.3
Lanes	2	3	1	2	3	1	1	1	1	1	1	1
Cap, veh/h	197	2502	702	270	2619	764	326	429	357	323	429	357
Arrive On Green	0.06	0.45	0.45	0.08	0.47	0.47	0.05	0.23	0.23	0.05	0.23	0.23
Sat Flow, veh/h	3442	5588	1567	3442	5588	1631	1774	1863	1552	1774	1863	1552
Grp Volume(v), veh/h	132	2018	100	200	2456	243	141	150	193	100	150	172
Grp Sat Flow(s),veh/h/ln	1721	1863	1567	1721	1863	1631	1774	1863	1552	1774	1863	1552
Q Serve(g_s), s	3.9	32.0	3.9	5.8	42.7	9.5	5.0	6.9	11.2	4.4	6.9	9.8
Cycle Q Clear(g_c), s	3.9	32.0	3.9	5.8	42.7	9.5	5.0	6.9	11.2	4.4	6.9	9.8
Prop In Lane	1.00		1.00	1.00		1.00	1.00		1.00	1.00		1.00
Lane Grp Cap(c), veh/h	197	2502	702	270	2619	764	326	429	357	323	429	357
V/C Ratio(X)	0.67	0.81	0.14	0.74	0.94	0.32	0.43	0.35	0.54	0.31	0.35	0.48
Avail Cap(c_a), veh/h	403	2507	703	403	2619	764	326	672	560	323	672	560
HCM Platoon Ratio	1.00	1.00	1.00	1.00	1.00	1.00	1.00	1.00	1.00	1.00	1.00	1.00
Upstream Filter(I)	0.81	0.81	0.81	1.00	1.00	1.00	1.00	1.00	1.00	1.00	1.00	1.00
Uniform Delay (d), s/veh	47.4	24.5	16.7	46.2	25.8	17.0	30.6	33.0	34.7	28.5	33.0	34.2
Incr Delay (d2), s/veh	3.2	2.4	0.3	4.0	8.0	1.1	0.9	0.5	1.3	0.5	0.5	1.0
Initial Q Delay(d3),s/veh	0.0	0.0	0.0	0.0	0.0	0.0	0.0	0.0	0.0	0.0	0.0	0.0
%ile Back of Q (50%), veh/ln	1.8	14.6	1.5	2.7	20.6	3.7	0.8	3.3	4.4	2.0	3.3	3.8
Lane Grp Delay (d), s/veh	50.5	26.8	17.0	50.2	33.9	18.1	31.5	33.5	36.0	29.0	33.5	35.2
Lane Grp LOS	D	C	B	D	C	B	C	C	D	C	C	D
Approach Vol, veh/h		2250			2899			484			422	
Approach Delay, s/veh		27.8			33.7			33.9			33.1	
Approach LOS		C			C			C			C	
Timer												
Assigned Phs	7	4		3	8		5	2		1	6	
Phs Duration (G+Y+Rc), s	10.9	50.9		13.0	53.0		10.0	28.6		10.0	28.6	
Change Period (Y+Rc), s	5.0	5.0		5.0	5.0		5.0	5.0		5.0	5.0	
Max Green Setting (Gmax), s	12.0	46.0		12.0	46.0		5.0	37.0		5.0	37.0	
Max Q Clear Time (g_c+I1), s	5.9	34.0		7.8	44.7		7.0	13.2		6.4	11.8	
Green Ext Time (p_c), s	0.2	11.9		0.2	1.3		0.0	3.1		0.0	3.1	
Intersection Summary												
HCM 2010 Ctrl Delay			31.5									
HCM 2010 LOS			C									
Notes												

HCM 2010 Signalized Intersection Summary
 14: Transit Blvd & Unser Blvd

						
Movement	EBT	EBR	WBL	WBT	NBL	NBR
Lane Configurations	↑↑	↑	↑↑	↑↑	↑	↑
Volume (veh/h)	999	100	182	810	175	309
Number	4	14	3	8	5	12
Initial Q (Qb), veh	0	0	0	0	0	0
Ped-Bike Adj(A_pbT)		0.98	1.00		1.00	1.00
Parking Bus Adj	1.00	1.00	1.00	1.00	1.00	1.00
Adj Sat Flow veh/h/ln	186.3	186.3	186.3	186.3	186.3	186.3
Lanes	2	1	2	2	1	1
Cap, veh/h	1693	708	252	2134	596	532
Arrive On Green	0.45	0.45	0.07	0.57	0.34	0.34
Sat Flow, veh/h	3725	1557	3442	3725	1774	1583
Grp Volume(v), veh/h	999	100	182	810	175	309
Grp Sat Flow(s),veh/h/ln	1863	1557	1721	1863	1774	1583
Q Serve(g_s), s	22.0	4.1	5.7	13.1	8.0	17.7
Cycle Q Clear(g_c), s	22.0	4.1	5.7	13.1	8.0	17.7
Prop In Lane		1.00	1.00		1.00	1.00
Lane Grp Cap(c), veh/h	1693	708	252	2134	596	532
V/C Ratio(X)	0.59	0.14	0.72	0.38	0.29	0.58
Avail Cap(c_a), veh/h	1693	708	563	2134	596	532
HCM Platoon Ratio	1.00	1.00	1.00	1.00	1.00	1.00
Upstream Filter(I)	1.00	1.00	1.00	1.00	1.00	1.00
Uniform Delay (d), s/veh	22.4	17.5	49.9	12.8	26.9	30.1
Incr Delay (d2), s/veh	1.5	0.4	3.9	0.1	1.2	4.6
Initial Q Delay(d3),s/veh	0.0	0.0	0.0	0.0	0.0	0.0
%ile Back of Q (50%), veh/ln	10.2	1.6	2.6	5.4	3.8	7.5
Lane Grp Delay (d), s/veh	23.9	17.9	53.8	12.9	28.1	34.7
Lane Grp LOS	C	B	D	B	C	C
Approach Vol, veh/h	1099			992	484	
Approach Delay, s/veh	23.4			20.4	32.3	
Approach LOS	C			C	C	
Timer						
Assigned Phs	4		3	8		
Phs Duration (G+Y+Rc), s	55.0		13.0	68.0		
Change Period (Y+Rc), s	5.0		5.0	5.0		
Max Green Setting (Gmax), s	50.0		18.0	50.0		
Max Q Clear Time (g_c+I1), s	24.0		7.7	15.1		
Green Ext Time (p_c), s	14.2		0.4	16.5		
Intersection Summary						
HCM 2010 Ctrl Delay			23.9			
HCM 2010 LOS			C			
Notes						

























HCM 2010 Signalized Intersection Summary
101: Paseo del Norte & Loop Rd W

Scheme D -- Year 2035 PM
6/6/2013

												
Movement	EBL	EBT	EBR	WBL	WBT	WBR	SEL	SET	SER	NWL	NWT	NWR
Lane Configurations												
Volume (veh/h)	114	100	246	133	100	137	131	1730	172	261	2200	250
Number	5	2	12	1	6	16	7	4	14	3	8	18
Initial Q (Qb), veh	0	0	0	0	0	0	0	0	0	0	0	0
Ped-Bike Adj(A_pbT)	0.98		0.98	0.99		0.98	1.00		0.98	1.00		0.99
Parking Bus Adj	1.00	1.00	1.00	1.00	1.00	1.00	1.00	1.00	1.00	1.00	1.00	1.00
Adj Sat Flow veh/h/ln	186.3	186.3	186.3	186.3	186.3	186.3	186.3	186.3	193.7	186.3	186.3	193.7
Lanes	1	1	1	1	1	1	1	3	1	1	3	1
Cap, veh/h	312	490	407	289	490	407	169	2823	815	174	2837	826
Arrive On Green	0.26	0.26	0.26	0.26	0.26	0.26	0.10	0.51	0.51	0.20	1.00	1.00
Sat Flow, veh/h	1121	1863	1547	1017	1863	1547	1774	5588	1614	1774	5588	1627
Grp Volume(v), veh/h	114	100	246	133	100	137	131	1730	172	261	2200	250
Grp Sat Flow(s),veh/h/ln	1121	1863	1547	1017	1863	1547	1774	1863	1614	1774	1863	1627
Q Serve(g_s), s	9.9	4.7	15.6	13.1	4.7	8.0	8.1	24.9	6.6	11.0	0.0	0.0
Cycle Q Clear(g_c), s	14.6	4.7	15.6	17.8	4.7	8.0	8.1	24.9	6.6	11.0	0.0	0.0
Prop In Lane	1.00		1.00	1.00		1.00	1.00		1.00	1.00		1.00
Lane Grp Cap(c), veh/h	312	490	407	289	490	407	169	2823	815	174	2837	826
V/C Ratio(X)	0.36	0.20	0.60	0.46	0.20	0.34	0.77	0.61	0.21	1.50	0.78	0.30
Avail Cap(c_a), veh/h	387	614	510	357	614	510	174	2837	819	174	2837	826
HCM Platoon Ratio	1.00	1.00	1.00	1.00	1.00	1.00	1.00	1.00	1.00	2.00	2.00	2.00
Upstream Filter(I)	1.00	1.00	1.00	1.00	1.00	1.00	0.63	0.63	0.63	0.09	0.09	0.09
Uniform Delay (d), s/veh	37.9	32.2	36.2	39.1	32.2	33.4	49.6	19.9	15.4	45.1	0.0	0.0
Incr Delay (d2), s/veh	0.7	0.2	1.4	1.1	0.2	0.5	12.4	0.2	0.1	228.4	0.2	0.1
Initial Q Delay(d3),s/veh	0.0	0.0	0.0	0.0	0.0	0.0	0.0	0.0	0.0	0.0	0.0	0.0
%ile Back of Q (50%), veh/ln	2.9	2.2	6.1	3.5	2.2	3.1	4.2	11.0	2.5	15.4	0.1	0.0
Lane Grp Delay (d), s/veh	38.6	32.4	37.7	40.3	32.4	33.9	62.0	20.1	15.5	273.6	0.2	0.1
Lane Grp LOS	D	C	D	D	C	C	E	C	B	F	A	A
Approach Vol, veh/h		460			370			2033			2711	
Approach Delay, s/veh		36.8			35.8			22.5			26.5	
Approach LOS		D			D			C			C	
Timer												
Assigned Phs		2			6		7	4		3		8
Phs Duration (G+Y+Rc), s		34.5			34.5		15.7	61.7		16.0		62.0
Change Period (Y+Rc), s		5.0			5.0		5.0	5.0		5.0		5.0
Max Green Setting (Gmax), s		37.0			37.0		11.0	57.0		11.0		57.0
Max Q Clear Time (g_c+I1), s		17.6			19.8		10.1	26.9		13.0		2.0
Green Ext Time (p_c), s		3.2			3.1		0.8	16.6		0.0		31.6
Intersection Summary												
HCM 2010 Ctrl Delay			26.5									
HCM 2010 LOS			C									
Notes												































HCM 2010 Signalized Intersection Summary
 102: Unser Blvd & Loop Rd N

Scheme D -- Year 2035 PM
 6/6/2013

												
Movement	SEL	SET	SER	NWL	NWT	NWR	NEL	NET	NER	SWL	SWT	SWR
Lane Configurations												
Volume (veh/h)	100	100	150	150	100	150	131	850	125	100	791	63
Number	1	6	16	5	2	12	7	4	14	3	8	18
Initial Q (Qb), veh	0	0	0	0	0	0	0	0	0	0	0	0
Ped-Bike Adj(A_pbT)	1.00		1.00	1.00		1.00	1.00		1.00	1.00		1.00
Parking Bus Adj	1.00	1.00	1.00	1.00	1.00	1.00	1.00	1.00	1.00	1.00	1.00	1.00
Adj Sat Flow veh/h/ln	186.3	186.3	186.3	186.3	186.3	186.3	186.3	186.3	186.3	186.3	186.3	186.3
Lanes	1	1	1	1	1	1	1	2	1	1	2	1
Cap, veh/h	261	403	343	261	403	343	458	2568	1091	411	2568	1091
Arrive On Green	0.22	0.22	0.22	0.22	0.22	0.22	0.69	0.69	0.69	0.69	0.69	0.69
Sat Flow, veh/h	1125	1863	1583	1125	1863	1583	644	3725	1583	574	3725	1583
Grp Volume(v), veh/h	100	100	150	150	100	150	131	850	125	100	791	63
Grp Sat Flow(s),veh/h/ln	1125	1863	1583	1125	1863	1583	644	1863	1583	574	1863	1583
Q Serve(g_s), s	8.6	4.7	8.7	13.5	4.7	8.7	10.7	9.7	2.8	9.0	8.9	1.4
Cycle Q Clear(g_c), s	13.3	4.7	8.7	18.2	4.7	8.7	19.6	9.7	2.8	18.7	8.9	1.4
Prop In Lane	1.00		1.00	1.00		1.00	1.00		1.00	1.00		1.00
Lane Grp Cap(c), veh/h	261	403	343	261	403	343	458	2568	1091	411	2568	1091
V/C Ratio(X)	0.38	0.25	0.44	0.57	0.25	0.44	0.29	0.33	0.11	0.24	0.31	0.06
Avail Cap(c_a), veh/h	411	651	553	411	651	553	458	2568	1091	411	2568	1091
HCM Platoon Ratio	1.00	1.00	1.00	1.00	1.00	1.00	1.00	1.00	1.00	1.00	1.00	1.00
Upstream Filter(I)	1.00	1.00	1.00	1.00	1.00	1.00	0.53	0.53	0.53	1.00	1.00	1.00
Uniform Delay (d), s/veh	39.9	34.4	35.9	41.9	34.4	35.9	10.4	6.6	5.6	10.4	6.5	5.3
Incr Delay (d2), s/veh	0.9	0.3	0.9	2.0	0.3	0.9	0.8	0.2	0.1	1.4	0.3	0.1
Initial Q Delay(d3),s/veh	0.0	0.0	0.0	0.0	0.0	0.0	0.0	0.0	0.0	0.0	0.0	0.0
%ile Back of Q (50%), veh/ln	2.5	2.3	3.5	4.0	2.3	3.5	1.6	3.7	0.9	1.3	3.4	0.5
Lane Grp Delay (d), s/veh	40.8	34.7	36.8	43.9	34.7	36.8	11.2	6.8	5.7	11.8	6.8	5.4
Lane Grp LOS	D	C	D	D	C	D	B	A	A	B	A	A
Approach Vol, veh/h		350			400			1106			954	
Approach Delay, s/veh		37.3			38.9			7.2			7.2	
Approach LOS		D			D			A			A	
Timer												
Assigned Phs		6			2			4			8	
Phs Duration (G+Y+Rc), s		27.9			27.9			78.0			78.0	
Change Period (Y+Rc), s		5.0			5.0			5.0			5.0	
Max Green Setting (Gmax), s		37.0			37.0			73.0			73.0	
Max Q Clear Time (g_c+I1), s		15.3			20.2			21.6			20.7	
Green Ext Time (p_c), s		2.9			2.7			19.0			19.1	
Intersection Summary												
HCM 2010 Ctrl Delay			15.5									
HCM 2010 LOS			B									
Notes												

























HCM 2010 Signalized Intersection Summary
 103: Loop Rd E/Loop Rd East & Paseo del Norte

Scheme D -- Year 2035 PM
 6/6/2013

												
Movement	SEL	SET	SER	NWL	NWT	NWR	NEL	NET	NER	SWL	SWT	SWR
Lane Configurations	 	  		 	  							
Volume (veh/h)	100	1900	250	262	2233	343	135	100	272	78	100	293
Number	7	4	14	3	8	18	5	2	12	1	6	16
Initial Q (Qb), veh	0	0	0	0	0	0	0	0	0	0	0	0
Ped-Bike Adj(A_pbT)	1.00		0.99	1.00		0.99	0.99		0.98	0.99		0.98
Parking Bus Adj	1.00	1.00	1.00	1.00	1.00	1.00	1.00	1.00	1.00	1.00	1.00	1.00
Adj Sat Flow veh/h/ln	167.6	167.6	174.4	167.6	167.6	174.4	167.6	167.6	167.6	167.6	167.6	167.6
Lanes	2	3	1	2	3	1	1	1	1	1	1	1
Cap, veh/h	316	2441	710	316	2441	710	270	470	391	274	470	391
Arrive On Green	0.10	0.49	0.49	0.10	0.49	0.49	0.28	0.28	0.28	0.28	0.28	0.28
Sat Flow, veh/h	3097	5029	1464	3097	5029	1464	878	1676	1395	895	1676	1395
Grp Volume(v), veh/h	100	1900	250	262	2233	343	135	100	272	78	100	293
Grp Sat Flow(s),veh/h/ln	1549	1676	1464	1549	1676	1464	878	1676	1395	895	1676	1395
Q Serve(g_s), s	3.4	35.4	12.0	9.4	46.6	17.8	15.8	5.2	19.8	8.3	5.2	21.7
Cycle Q Clear(g_c), s	3.4	35.4	12.0	9.4	46.6	17.8	20.9	5.2	19.8	13.5	5.2	21.7
Prop In Lane	1.00		1.00	1.00		1.00	1.00		1.00	1.00		1.00
Lane Grp Cap(c), veh/h	316	2441	710	316	2441	710	270	470	391	274	470	391
V/C Ratio(X)	0.32	0.78	0.35	0.83	0.91	0.48	0.50	0.21	0.70	0.29	0.21	0.75
Avail Cap(c_a), veh/h	355	2441	710	355	2441	710	310	547	455	315	547	455
HCM Platoon Ratio	1.00	1.00	1.00	1.00	1.00	1.00	1.00	1.00	1.00	1.00	1.00	1.00
Upstream Filter(I)	0.33	0.33	0.33	0.65	0.65	0.65	1.00	1.00	1.00	1.00	1.00	1.00
Uniform Delay (d), s/veh	47.2	24.1	18.1	49.9	27.0	19.6	39.2	31.2	36.4	36.3	31.2	37.1
Incr Delay (d2), s/veh	0.2	0.9	0.5	9.4	4.6	1.5	1.4	0.2	3.8	0.6	0.2	5.8
Initial Q Delay(d3),s/veh	0.0	0.0	0.0	0.0	0.0	0.0	0.0	0.0	0.0	0.0	0.0	0.0
%ile Back of Q (50%), veh/ln	1.3	14.3	4.3	4.1	19.4	6.5	3.6	2.2	7.2	1.9	2.2	8.1
Lane Grp Delay (d), s/veh	47.4	25.0	18.6	59.4	31.6	21.1	40.6	31.4	40.2	36.9	31.4	42.9
Lane Grp LOS	D	C	B	E	C	C	D	C	D	D	C	D
Approach Vol, veh/h		2250			2838			507			471	
Approach Delay, s/veh		25.3			32.9			38.6			39.5	
Approach LOS		C			C			D			D	
Timer												
Assigned Phs	7	4		3	8			2			6	
Phs Duration (G+Y+Rc), s	16.5	60.0		16.5	60.0			36.8			36.8	
Change Period (Y+Rc), s	5.0	5.0		5.0	5.0			5.0			5.0	
Max Green Setting (Gmax), s	13.0	55.0		13.0	55.0			37.0			37.0	
Max Q Clear Time (g_c+I1), s	5.4	37.4		11.4	48.6			22.9			23.7	
Green Ext Time (p_c), s	6.4	12.9		0.1	5.8			3.5			3.4	
Intersection Summary												
HCM 2010 Ctrl Delay			31.0									
HCM 2010 LOS			C									
Notes												

HCM 2010 Signalized Intersection Summary
 104: Unser Blvd & Loop Rd S

Scheme D -- Year 2035 PM
 6/6/2013

												
Movement	EBL	EBT	EBR	WBL	WBT	WBR	NBL	NBT	NBR	SBL	SBT	SBR
Lane Configurations												
Volume (veh/h)	50	100	180	180	100	100	121	1105	202	50	800	201
Number	7	4	14	3	8	18	5	2	12	1	6	16
Initial Q (Qb), veh	0	0	0	0	0	0	0	0	0	0	0	0
Ped-Bike Adj(A_pbT)	1.00		1.00	1.00		1.00	1.00		1.00	1.00		1.00
Parking Bus Adj	1.00	1.00	1.00	1.00	1.00	1.00	1.00	1.00	1.00	1.00	1.00	1.00
Adj Sat Flow veh/h/ln	186.3	186.3	186.3	186.3	186.3	186.3	186.3	186.3	186.3	186.3	186.3	186.3
Lanes	1	1	1	1	1	1	1	2	1	1	2	1
Cap, veh/h	435	639	543	410	639	543	316	2059	875	228	2059	875
Arrive On Green	0.34	0.34	0.34	0.34	0.34	0.34	0.55	0.55	0.55	0.55	0.55	0.55
Sat Flow, veh/h	1178	1863	1583	1095	1863	1583	561	3725	1583	419	3725	1583
Grp Volume(v), veh/h	50	100	180	180	100	100	121	1105	202	50	800	201
Grp Sat Flow(s),veh/h/ln	1178	1863	1583	1095	1863	1583	561	1863	1583	419	1863	1583
Q Serve(g_s), s	3.0	3.6	8.1	13.1	3.6	4.3	15.1	18.1	6.3	8.3	11.8	6.3
Cycle Q Clear(g_c), s	6.5	3.6	8.1	16.7	3.6	4.3	26.8	18.1	6.3	26.4	11.8	6.3
Prop In Lane	1.00		1.00	1.00		1.00	1.00		1.00	1.00		1.00
Lane Grp Cap(c), veh/h	435	639	543	410	639	543	316	2059	875	228	2059	875
V/C Ratio(X)	0.11	0.16	0.33	0.44	0.16	0.18	0.38	0.54	0.23	0.22	0.39	0.23
Avail Cap(c_a), veh/h	435	639	543	410	639	543	455	2984	1268	332	2984	1268
HCM Platoon Ratio	1.00	1.00	1.00	1.00	1.00	1.00	1.00	1.00	1.00	1.00	1.00	1.00
Upstream Filter(I)	1.00	1.00	1.00	1.00	1.00	1.00	0.46	0.46	0.46	0.66	0.66	0.66
Uniform Delay (d), s/veh	24.2	21.9	23.4	27.7	21.9	22.1	19.9	13.7	11.0	22.1	12.2	11.0
Incr Delay (d2), s/veh	0.5	0.5	1.6	3.4	0.5	0.7	0.4	0.1	0.1	0.3	0.1	0.1
Initial Q Delay(d3),s/veh	0.0	0.0	0.0	0.0	0.0	0.0	0.0	0.0	0.0	0.0	0.0	0.0
%ile Back of Q (50%), veh/ln	0.9	1.8	3.4	3.9	1.8	1.8	2.0	7.4	2.1	0.9	4.8	2.1
Lane Grp Delay (d), s/veh	24.7	22.4	25.0	31.1	22.4	22.9	20.2	13.8	11.1	22.4	12.3	11.1
Lane Grp LOS	C	C	C	C	C	C	C	B	B	C	B	B
Approach Vol, veh/h		330			380			1428			1051	
Approach Delay, s/veh		24.2			26.7			13.9			12.6	
Approach LOS		C			C			B			B	
Timer												
Assigned Phs		4			8			2			6	
Phs Duration (G+Y+Rc), s		38.0			38.0			58.1			58.1	
Change Period (Y+Rc), s		5.0			5.0			5.0			5.0	
Max Green Setting (Gmax), s		33.0			33.0			77.0			77.0	
Max Q Clear Time (g_c+I1), s		10.1			18.7			28.8			28.4	
Green Ext Time (p_c), s		2.8			2.5			24.3			24.4	
Intersection Summary												
HCM 2010 Ctrl Delay				16.1								
HCM 2010 LOS				B								
Notes												

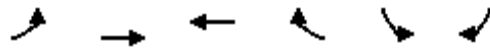

Movement	EBL	EBT	WBT	WBR	SBL	SBR
Lane Configurations						
Volume (veh/h)	150	2100	2626	143	150	212
Number	7	4	8	18	1	16
Initial Q (Qb), veh	0	0	0	0	0	0
Ped-Bike Adj(A_pbT)	1.00			1.00	1.00	1.00
Parking Bus Adj	1.00	1.00	1.00	1.00	1.00	1.00
Adj Sat Flow veh/h/ln	186.3	186.3	186.3	186.3	186.3	186.3
Lanes	2	3	3	1	1	1
Cap, veh/h	288	4123	4123	1168	286	255
Arrive On Green	0.74	0.74	1.00	1.00	0.16	0.16
Sat Flow, veh/h	194	5588	5588	1583	1774	1583
Grp Volume(v), veh/h	150	2100	2626	143	150	212
Grp Sat Flow(s),veh/h/ln	97	1863	1863	1583	1774	1583
Q Serve(g_s), s	73.0	15.6	0.0	0.0	7.7	12.8
Cycle Q Clear(g_c), s	73.0	15.6	0.0	0.0	7.7	12.8
Prop In Lane	1.00			1.00	1.00	1.00
Lane Grp Cap(c), veh/h	288	4123	4123	1168	286	255
V/C Ratio(X)	0.52	0.51	0.64	0.12	0.52	0.83
Avail Cap(c_a), veh/h	288	4123	4123	1168	663	592
HCM Platoon Ratio	1.00	1.00	2.00	2.00	1.00	1.00
Upstream Filter(I)	0.61	0.61	0.39	0.39	1.00	1.00
Uniform Delay (d), s/veh	14.7	5.5	0.0	0.0	38.0	40.2
Incr Delay (d2), s/veh	1.0	0.1	0.3	0.1	1.5	6.9
Initial Q Delay(d3),s/veh	0.0	0.0	0.0	0.0	0.0	0.0
%ile Back of Q (50%), veh/ln	1.6	5.3	0.1	0.0	3.6	5.6
Lane Grp Delay (d), s/veh	15.7	5.5	0.3	0.1	39.5	47.0
Lane Grp LOS	B	A	A	A	D	D
Approach Vol, veh/h		2250	2769		362	
Approach Delay, s/veh		6.2	0.3		43.9	
Approach LOS		A	A		D	
Timer						
Assigned Phs		4	8			
Phs Duration (G+Y+Rc), s		78.0	78.0			
Change Period (Y+Rc), s		5.0	5.0			
Max Green Setting (Gmax), s		73.0	73.0			
Max Q Clear Time (g_c+I1), s		75.0	2.0			
Green Ext Time (p_c), s		0.0	68.9			
Intersection Summary						
HCM 2010 Ctrl Delay			5.7			
HCM 2010 LOS			A			
Notes						

Appendix B

Synchro Outputs: Signal Phasing

Timing Report, Sorted By Phase
11: Universe & Paseo del Norte

Scheme A -- Year 2035 PM

6/1/2013

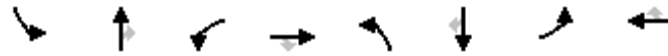

Phase Number	1	2	3	4	5	6	7	8
Movement	SBL	NBT	WBL	EBT	NBL	SBT	EBL	WBT
Lead/Lag	Lead	Lag	Lead	Lag	Lead	Lag	Lag	Lead
Lead-Lag Optimize	Yes	Yes	Yes	Yes	Yes	Yes	Yes	Yes
Recall Mode	None	None	None	None	None	None	None	C-Max
Maximum Split (s)	11.5	42	11.5	55	11.5	42	11.5	55
Maximum Split (%)	9.6%	35.0%	9.6%	45.8%	9.6%	35.0%	9.6%	45.8%
Minimum Split (s)	9	42	9	35	9	42	9	35
Yellow Time (s)	3.5	4	3.5	4	3.5	4	3.5	4
All-Red Time (s)	1	1	1	1	1	1	1	1
Minimum Initial (s)	4	4	4	4	4	4	4	4
Vehicle Extension (s)	3	3	3	3	3	3	3	3
Minimum Gap (s)	3	3	3	3	3	3	3	3
Time Before Reduce (s)	0	0	0	0	0	0	0	0
Time To Reduce (s)	0	0	0	0	0	0	0	0
Walk Time (s)		7		7		7		7
Flash Dont Walk (s)		30		23		30		23
Dual Entry	No	Yes	No	Yes	No	Yes	No	Yes
Inhibit Max	Yes	Yes	Yes	Yes	Yes	Yes	Yes	Yes
Start Time (s)	6.5	18	60	71.5	6.5	18	115	60
End Time (s)	18	60	71.5	6.5	18	60	6.5	115
Yield/Force Off (s)	13.5	55	67	1.5	13.5	55	2	110
Yield/Force Off 170(s)	13.5	25	67	98.5	13.5	25	2	87
Local Start Time (s)	66.5	78	0	11.5	66.5	78	55	0
Local Yield (s)	73.5	115	7	61.5	73.5	115	62	50
Local Yield 170(s)	73.5	85	7	38.5	73.5	85	62	27

Intersection Summary

Cycle Length	120
Control Type	Actuated-Coordinated
Natural Cycle	115
Offset: 60 (50%), Referenced to phase 8:WBT, Start of Green	

Splits and Phases: 11: Universe & Paseo del Norte

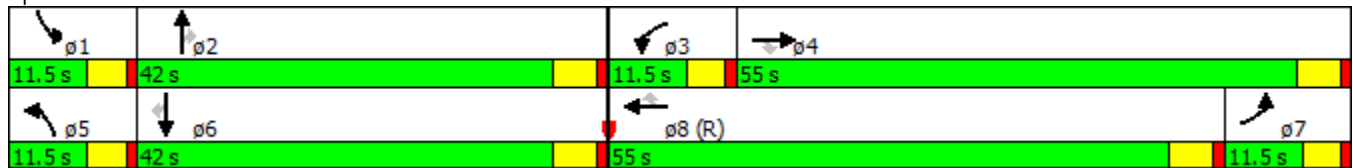

Timing Report, Sorted By Phase
12: Unser Blvd & Paseo del Norte

Scheme A -- Year 2035 PM

6/1/2013



Phase Number	1	2	3	4	5	6	7	8
Movement	SWL	NETL	NWL	SET	NEL	SWTL	SEL	NWT
Lead/Lag	Lead	Lag	Lead	Lag	Lead	Lag	Lead	Lag
Lead-Lag Optimize	Yes	Yes	Yes	Yes	Yes	Yes	Yes	Yes
Recall Mode	None	None	None	Max	None	None	None	C-Max
Maximum Split (s)	13	42	15	50	13	42	15	50
Maximum Split (%)	10.8%	35.0%	12.5%	41.7%	10.8%	35.0%	12.5%	41.7%
Minimum Split (s)	9	42	9	41	9	42	9	41
Yellow Time (s)	4	4	4	4	4	4	4	4
All-Red Time (s)	1	1	1	1	1	1	1	1
Minimum Initial (s)	4	4	4	4	4	4	4	4
Vehicle Extension (s)	3	3	3	3	3	3	3	3
Minimum Gap (s)	3	3	3	3	3	3	3	3
Time Before Reduce (s)	0	0	0	0	0	0	0	0
Time To Reduce (s)	0	0	0	0	0	0	0	0
Walk Time (s)		7		7		7		7
Flash Dont Walk (s)		30		29		30		29
Dual Entry	No	Yes	No	Yes	No	Yes	No	Yes
Inhibit Max	Yes	Yes	Yes	Yes	Yes	Yes	Yes	Yes
Start Time (s)	50	63	105	0	50	63	105	0
End Time (s)	63	105	0	50	63	105	0	50
Yield/Force Off (s)	58	100	115	45	58	100	115	45
Yield/Force Off 170(s)	58	70	115	16	58	70	115	16
Local Start Time (s)	50	63	105	0	50	63	105	0
Local Yield (s)	58	100	115	45	58	100	115	45
Local Yield 170(s)	58	70	115	16	58	70	115	16

Intersection Summary

Cycle Length	120
Control Type	Actuated-Coordinated
Natural Cycle	125
Offset: 0 (0%), Referenced to phase 8:NWT, Start of Green, Master Intersection	

Splits and Phases: 12: Unser Blvd & Paseo del Norte

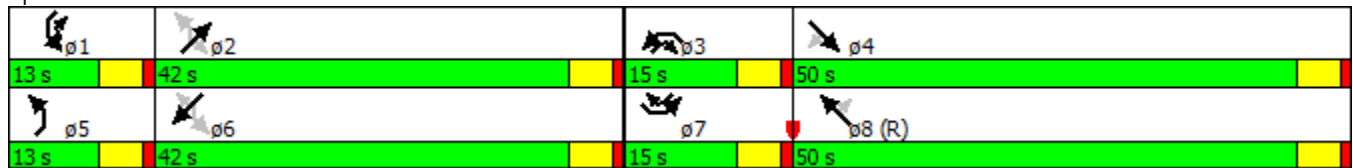

Timing Report, Sorted By Phase
 13: Kimmick Rd & Paseo del Norte

Scheme A -- Year 2035 PM

6/1/2013

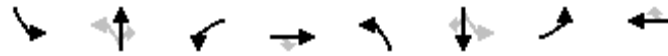

Phase Number	1	2	3	4	5	6	7	8
Movement	SBL	NBTL	WBL	EBT	NBL	SBTL	EBL	WBT
Lead/Lag	Lead	Lag	Lead	Lag	Lead	Lag	Lead	Lag
Lead-Lag Optimize	Yes	Yes			Yes	Yes	Yes	
Recall Mode	None	None	None	C-Min	None	None	None	C-Max
Maximum Split (s)	10	42	17	51	10	42	17	51
Maximum Split (%)	8.3%	35.0%	14.2%	42.5%	8.3%	35.0%	14.2%	42.5%
Minimum Split (s)	9	42	9.5	23	9	42	9.5	23
Yellow Time (s)	4	4	4	4	4	4	4	4
All-Red Time (s)	1	1	1	1	1	1	1	1
Minimum Initial (s)	4	4	4	4	4	4	4	4
Vehicle Extension (s)	3	3	3	3	3	3	3	3
Minimum Gap (s)	3	3	3	3	3	3	3	3
Time Before Reduce (s)	0	0	0	0	0	0	0	0
Time To Reduce (s)	0	0	0	0	0	0	0	0
Walk Time (s)		7		7		7		7
Flash Dont Walk (s)		30		11		30		11
Dual Entry	No	Yes	No	Yes	No	Yes	No	Yes
Inhibit Max	Yes	Yes	Yes	Yes	Yes	Yes	Yes	Yes
Start Time (s)	111	1	43	60	111	1	43	60
End Time (s)	1	43	60	111	1	43	60	111
Yield/Force Off (s)	116	38	55	106	116	38	55	106
Yield/Force Off 170(s)	116	8	55	95	116	8	55	95
Local Start Time (s)	51	61	103	0	51	61	103	0
Local Yield (s)	56	98	115	46	56	98	115	46
Local Yield 170(s)	56	68	115	35	56	68	115	35

Intersection Summary

Cycle Length	120
Control Type	Actuated-Coordinated
Natural Cycle	135
Offset: 60 (50%), Referenced to phase 4:EBT and 8:WBT, Start of Green	

Splits and Phases: 13: Kimmick Rd & Paseo del Norte

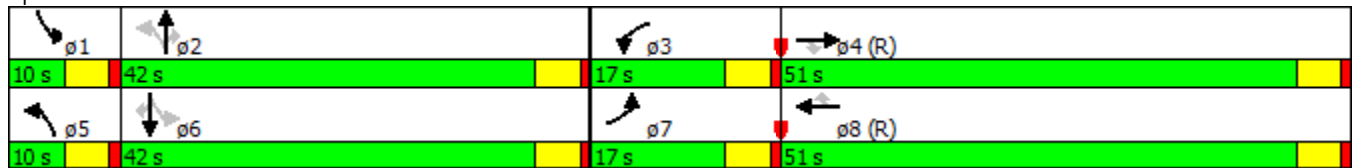

Timing Report, Sorted By Phase
14: Transit Blvd & Unser Blvd

Scheme A -- Year 2035 PM

6/1/2013

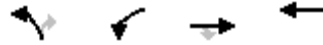

Phase Number	2	3	4	8
Movement	NBL	WBL	EBT	WBT
Lead/Lag		Lead	Lag	
Lead-Lag Optimize		Yes	Yes	
Recall Mode	Max	None	C-Max	None
Maximum Split (s)	42	23	55	55
Maximum Split (%)	35.0%	19.2%	45.8%	45.8%
Minimum Split (s)	37	9.5	23	23
Yellow Time (s)	4	4	4	4
All-Red Time (s)	1	1	1	1
Minimum Initial (s)	4	4	4	4
Vehicle Extension (s)	3	3	3	3
Minimum Gap (s)	3	3	3	3
Time Before Reduce (s)	0	0	0	0
Time To Reduce (s)	0	0	0	0
Walk Time (s)	7		7	7
Flash Dont Walk (s)	25		11	11
Dual Entry	Yes	No	Yes	Yes
Inhibit Max	Yes	Yes	Yes	Yes
Start Time (s)	55	97	0	97
End Time (s)	97	0	55	55
Yield/Force Off (s)	92	115	50	50
Yield/Force Off 170(s)	67	115	39	39
Local Start Time (s)	55	97	0	97
Local Yield (s)	92	115	50	50
Local Yield 170(s)	67	115	39	39

Intersection Summary

Cycle Length	120
Control Type	Actuated-Coordinated
Natural Cycle	75
Offset: 0 (0%), Referenced to phase 4:EBT, Start of Green	

Splits and Phases: 14: Transit Blvd & Unser Blvd

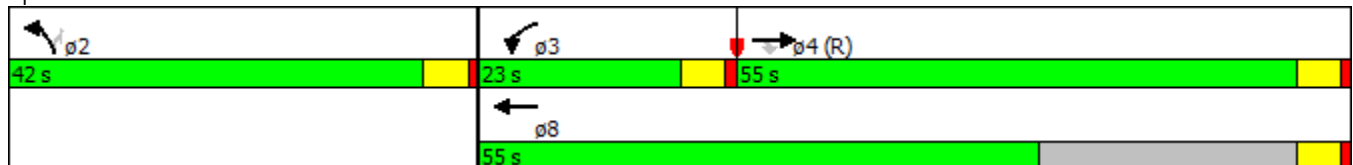

Timing Report, Sorted By Phase
 101: Paseo del Norte & Loop Rd W/Loop Rd N

Scheme A -- Year 2035 PM
 6/1/2013



Phase Number	2	3	4	6	7	8
Movement	EBTL	NWL	SET	WBTL	SEL	NWT
Lead/Lag		Lead	Lag		Lag	Lead
Lead-Lag Optimize		Yes	Yes		Yes	Yes
Recall Mode	None	None	Min	None	None	C-Max
Maximum Split (s)	42	16	62	42	16	62
Maximum Split (%)	35.0%	13.3%	51.7%	35.0%	13.3%	51.7%
Minimum Split (s)	27	9	27	42	9	42
Yellow Time (s)	4	4	4	4	4	4
All-Red Time (s)	1	1	1	1	1	1
Minimum Initial (s)	4	4	4	4	4	4
Vehicle Extension (s)	3	3	3	3	3	3
Minimum Gap (s)	3	3	3	3	3	3
Time Before Reduce (s)	0	0	0	0	0	0
Time To Reduce (s)	0	0	0	0	0	0
Walk Time (s)	7		7	7		7
Flash Dont Walk (s)	15		15	30		30
Dual Entry	Yes	No	Yes	Yes	No	Yes
Inhibit Max	Yes	Yes	Yes	Yes	Yes	Yes
Start Time (s)	98	20	36	98	82	20
End Time (s)	20	36	98	20	98	82
Yield/Force Off (s)	15	31	93	15	93	77
Yield/Force Off 170(s)	0	31	93	105	93	47
Local Start Time (s)	78	0	16	78	62	0
Local Yield (s)	115	11	73	115	73	57
Local Yield 170(s)	100	11	73	85	73	27

Intersection Summary

Cycle Length	120
Control Type	Actuated-Coordinated
Natural Cycle	105
Offset: 20 (17%), Referenced to phase 8:NWT, Start of Green	

Splits and Phases: 101: Paseo del Norte & Loop Rd W/Loop Rd N

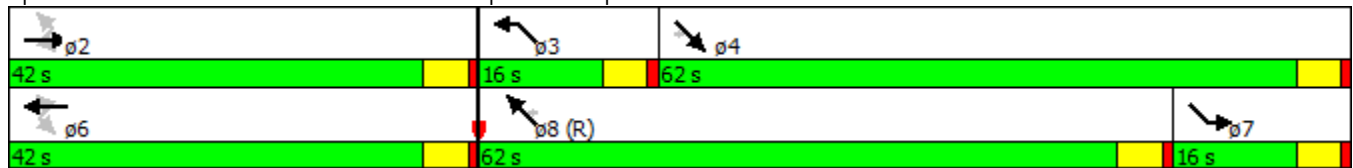

Timing Report, Sorted By Phase
102: Unser Blvd & Loop Rd N



Phase Number	2	4	6	8
Movement	NWTL	NETL	SETL	SWTL
Lead/Lag				
Lead-Lag Optimize				
Recall Mode	None	C-Max	None	C-Max
Maximum Split (s)	42	78	42	78
Maximum Split (%)	35.0%	65.0%	35.0%	65.0%
Minimum Split (s)	23	23	23	23
Yellow Time (s)	4	4	4	4
All-Red Time (s)	1	1	1	1
Minimum Initial (s)	4	4	4	4
Vehicle Extension (s)	3	3	3	3
Minimum Gap (s)	3	3	3	3
Time Before Reduce (s)	0	0	0	0
Time To Reduce (s)	0	0	0	0
Walk Time (s)	7	7	7	7
Flash Dont Walk (s)	11	11	11	11
Dual Entry	Yes	Yes	Yes	Yes
Inhibit Max	Yes	Yes	Yes	Yes
Start Time (s)	18	60	18	60
End Time (s)	60	18	60	18
Yield/Force Off (s)	55	13	55	13
Yield/Force Off 170(s)	44	2	44	2
Local Start Time (s)	78	0	78	0
Local Yield (s)	115	73	115	73
Local Yield 170(s)	104	62	104	62

Intersection Summary

Cycle Length	120
Control Type	Actuated-Coordinated
Natural Cycle	50
Offset: 60 (50%), Referenced to phase 4:NETL and 8:SWTL, Start of Green	

Splits and Phases: 102: Unser Blvd & Loop Rd N

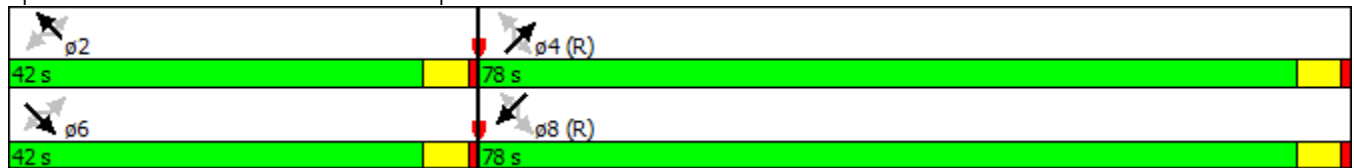

Timing Report, Sorted By Phase
 103: Avenita de Jaimito/Loop Rd East & Paseo del Norte

Scheme A -- Year 2035 PM
 6/1/2013



Phase Number	2	3	4	6	7	8
Movement	NETL	NWL	SET	SWTL	SEL	NWT
Lead/Lag		Lead	Lag		Lag	Lead
Lead-Lag Optimize		Yes	Yes			
Recall Mode	None	None	Max	None	None	C-Max
Maximum Split (s)	42	18	60	42	18	60
Maximum Split (%)	35.0%	15.0%	50.0%	35.0%	15.0%	50.0%
Minimum Split (s)	42	9	27	42	9	27
Yellow Time (s)	4	4	4	4	4	4
All-Red Time (s)	1	1	1	1	1	1
Minimum Initial (s)	4	4	4	4	4	4
Vehicle Extension (s)	3	3	3	3	3	3
Minimum Gap (s)	3	3	3	3	3	3
Time Before Reduce (s)	0	0	0	0	0	0
Time To Reduce (s)	0	0	0	0	0	0
Walk Time (s)	7		7	7		7
Flash Dont Walk (s)	30		15	30		15
Dual Entry	Yes	No	Yes	Yes	No	Yes
Inhibit Max	Yes	Yes	Yes	Yes	Yes	Yes
Start Time (s)	88	10	28	88	70	10
End Time (s)	10	28	88	10	88	70
Yield/Force Off (s)	5	23	83	5	83	65
Yield/Force Off 170(s)	95	23	68	95	83	50
Local Start Time (s)	78	0	18	78	60	0
Local Yield (s)	115	13	73	115	73	55
Local Yield 170(s)	85	13	58	85	73	40

Intersection Summary

Cycle Length	120
Control Type	Actuated-Coordinated
Natural Cycle	110
Offset: 10 (8%), Referenced to phase 8:NWT, Start of Green	

Splits and Phases: 103: Avenita de Jaimito/Loop Rd East & Paseo del Norte

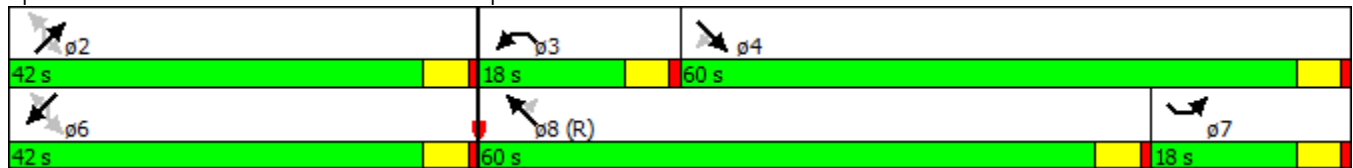

Timing Report, Sorted By Phase
 104: Unser Blvd & Loop Rd W/Avenida de Jaimito

Scheme A -- Year 2035 PM

6/1/2013



Phase Number	2	4	6	8
Movement	NBTL	EBTL	SBTL	WBTL
Lead/Lag				
Lead-Lag Optimize				
Recall Mode	None	C-Max	None	C-Max
Maximum Split (s)	82	38	82	38
Maximum Split (%)	68.3%	31.7%	68.3%	31.7%
Minimum Split (s)	23	23	23	23
Yellow Time (s)	4	4	4	4
All-Red Time (s)	1	1	1	1
Minimum Initial (s)	4	4	4	4
Vehicle Extension (s)	3	3	3	3
Minimum Gap (s)	3	3	3	3
Time Before Reduce (s)	0	0	0	0
Time To Reduce (s)	0	0	0	0
Walk Time (s)	7	7	7	7
Flash Dont Walk (s)	11	11	11	11
Dual Entry	Yes	Yes	Yes	Yes
Inhibit Max	Yes	Yes	Yes	Yes
Start Time (s)	38	0	38	0
End Time (s)	0	38	0	38
Yield/Force Off (s)	115	33	115	33
Yield/Force Off 170(s)	104	22	104	22
Local Start Time (s)	38	0	38	0
Local Yield (s)	115	33	115	33
Local Yield 170(s)	104	22	104	22

Intersection Summary

Cycle Length	120
Control Type	Actuated-Coordinated
Natural Cycle	50
Offset: 0 (0%), Referenced to phase 4:EBTL and 8:WBTL, Start of Green	

Splits and Phases: 104: Unser Blvd & Loop Rd W/Avenida de Jaimito

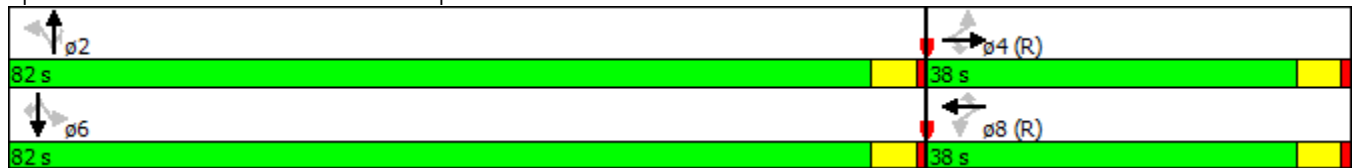

Timing Report, Sorted By Phase
11: Universe & Paseo del Norte

Scheme B -- Year 2035 PM

6/1/2013



Phase Number	1	2	3	4	5	6	7	8
Movement	SBL	NBT	WBL	EBT	NBL	SBT	EBL	WBT
Lead/Lag	Lead	Lag	Lead	Lag	Lead	Lag	Lag	Lead
Lead-Lag Optimize	Yes	Yes	Yes	Yes	Yes	Yes	Yes	Yes
Recall Mode	None	None	None	None	None	None	None	C-Max
Maximum Split (s)	11.5	42	11.5	55	11.5	42	11.5	55
Maximum Split (%)	9.6%	35.0%	9.6%	45.8%	9.6%	35.0%	9.6%	45.8%
Minimum Split (s)	9	42	9	35	9	42	9	35
Yellow Time (s)	3.5	4	3.5	4	3.5	4	3.5	4
All-Red Time (s)	1	1	1	1	1	1	1	1
Minimum Initial (s)	4	4	4	4	4	4	4	4
Vehicle Extension (s)	3	3	3	3	3	3	3	3
Minimum Gap (s)	3	3	3	3	3	3	3	3
Time Before Reduce (s)	0	0	0	0	0	0	0	0
Time To Reduce (s)	0	0	0	0	0	0	0	0
Walk Time (s)		7		7		7		7
Flash Dont Walk (s)		30		23		30		23
Dual Entry	No	Yes	No	Yes	No	Yes	No	Yes
Inhibit Max	Yes	Yes	Yes	Yes	Yes	Yes	Yes	Yes
Start Time (s)	6.5	18	60	71.5	6.5	18	115	60
End Time (s)	18	60	71.5	6.5	18	60	6.5	115
Yield/Force Off (s)	13.5	55	67	1.5	13.5	55	2	110
Yield/Force Off 170(s)	13.5	25	67	98.5	13.5	25	2	87
Local Start Time (s)	66.5	78	0	11.5	66.5	78	55	0
Local Yield (s)	73.5	115	7	61.5	73.5	115	62	50
Local Yield 170(s)	73.5	85	7	38.5	73.5	85	62	27

Intersection Summary

Cycle Length	120
Control Type	Actuated-Coordinated
Natural Cycle	115
Offset: 60 (50%), Referenced to phase 8:WBT, Start of Green	

Splits and Phases: 11: Universe & Paseo del Norte

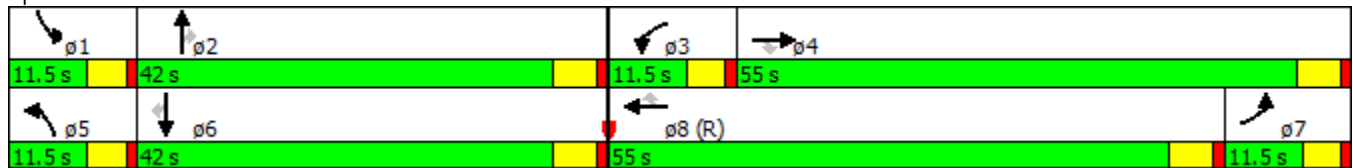

Timing Report, Sorted By Phase
12: Unser Blvd & Paseo del Norte

Scheme B -- Year 2035 PM

6/1/2013



Phase Number	1	2	3	4	5	6	7	8
Movement	SWL	NETL	NWL	SET	NEL	SWTL	SEL	NWT
Lead/Lag	Lead	Lag	Lead	Lag	Lead	Lag	Lead	Lag
Lead-Lag Optimize	Yes	Yes	Yes	Yes	Yes	Yes	Yes	Yes
Recall Mode	None	None	None	Max	None	None	None	C-Max
Maximum Split (s)	13	42	20	45	13	42	20	45
Maximum Split (%)	10.8%	35.0%	16.7%	37.5%	10.8%	35.0%	16.7%	37.5%
Minimum Split (s)	9	42	9	41	9	42	9	41
Yellow Time (s)	4	4	4	4	4	4	4	4
All-Red Time (s)	1	1	1	1	1	1	1	1
Minimum Initial (s)	4	4	4	4	4	4	4	4
Vehicle Extension (s)	3	3	3	3	3	3	3	3
Minimum Gap (s)	3	3	3	3	3	3	3	3
Time Before Reduce (s)	0	0	0	0	0	0	0	0
Time To Reduce (s)	0	0	0	0	0	0	0	0
Walk Time (s)		7		7		7		7
Flash Dont Walk (s)		30		29		30		29
Dual Entry	No	Yes	No	Yes	No	Yes	No	Yes
Inhibit Max	Yes	Yes	Yes	Yes	Yes	Yes	Yes	Yes
Start Time (s)	45	58	100	0	45	58	100	0
End Time (s)	58	100	0	45	58	100	0	45
Yield/Force Off (s)	53	95	115	40	53	95	115	40
Yield/Force Off 170(s)	53	65	115	11	53	65	115	11
Local Start Time (s)	45	58	100	0	45	58	100	0
Local Yield (s)	53	95	115	40	53	95	115	40
Local Yield 170(s)	53	65	115	11	53	65	115	11

Intersection Summary

Cycle Length	120
Control Type	Actuated-Coordinated
Natural Cycle	135
Offset: 0 (0%), Referenced to phase 8:NWT, Start of Green, Master Intersection	

Splits and Phases: 12: Unser Blvd & Paseo del Norte

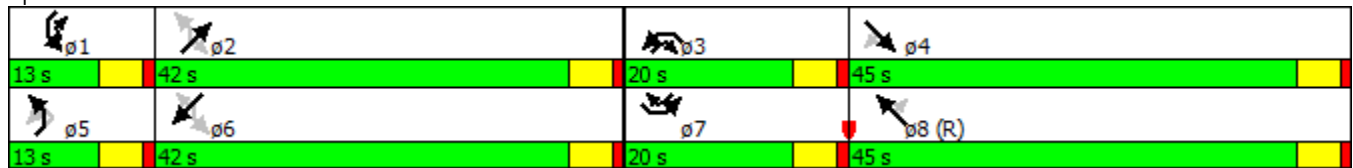

Timing Report, Sorted By Phase
 13: Kimmick Rd & Paseo del Norte

Scheme B -- Year 2035 PM

6/1/2013

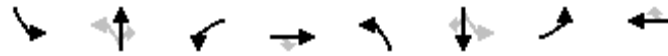

Phase Number	1	2	3	4	5	6	7	8
Movement	SBL	NBTL	WBL	EBT	NBL	SBTL	EBL	WBT
Lead/Lag	Lead	Lag	Lead	Lag	Lead	Lag	Lead	Lag
Lead-Lag Optimize	Yes	Yes			Yes	Yes	Yes	
Recall Mode	None	None	None	C-Min	None	None	None	C-Max
Maximum Split (s)	12	42	15	51	12	42	15	51
Maximum Split (%)	10.0%	35.0%	12.5%	42.5%	10.0%	35.0%	12.5%	42.5%
Minimum Split (s)	9	42	9.5	23	9	42	9.5	23
Yellow Time (s)	4	4	4	4	4	4	4	4
All-Red Time (s)	1	1	1	1	1	1	1	1
Minimum Initial (s)	4	4	4	4	4	4	4	4
Vehicle Extension (s)	3	3	3	3	3	3	3	3
Minimum Gap (s)	3	3	3	3	3	3	3	3
Time Before Reduce (s)	0	0	0	0	0	0	0	0
Time To Reduce (s)	0	0	0	0	0	0	0	0
Walk Time (s)		7		7		7		7
Flash Dont Walk (s)		30		11		30		11
Dual Entry	No	Yes	No	Yes	No	Yes	No	Yes
Inhibit Max	Yes	Yes	Yes	Yes	Yes	Yes	Yes	Yes
Start Time (s)	111	3	45	60	111	3	45	60
End Time (s)	3	45	60	111	3	45	60	111
Yield/Force Off (s)	118	40	55	106	118	40	55	106
Yield/Force Off 170(s)	118	10	55	95	118	10	55	95
Local Start Time (s)	51	63	105	0	51	63	105	0
Local Yield (s)	58	100	115	46	58	100	115	46
Local Yield 170(s)	58	70	115	35	58	70	115	35

Intersection Summary

Cycle Length	120
Control Type	Actuated-Coordinated
Natural Cycle	145
Offset: 60 (50%), Referenced to phase 4:EBT and 8:WBT, Start of Green	

Splits and Phases: 13: Kimmick Rd & Paseo del Norte

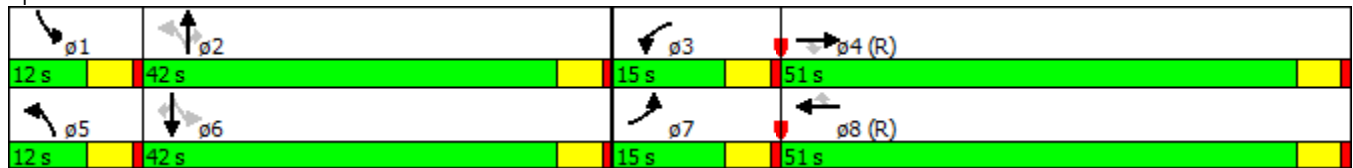

Timing Report, Sorted By Phase
14: Transit Blvd & Unser Blvd



Phase Number	2	3	4	7	8
Movement	NBL	WBL	EBT	EBU	WBT
Lead/Lag		Lead	Lag	Lead	Lag
Lead-Lag Optimize		Yes	Yes	Yes	Yes
Recall Mode	Max	None	C-Max	None	None
Maximum Split (s)	42	23	55	23	55
Maximum Split (%)	35.0%	19.2%	45.8%	19.2%	45.8%
Minimum Split (s)	37	9.5	23	9	23
Yellow Time (s)	4	4	4	4	4
All-Red Time (s)	1	1	1	1	1
Minimum Initial (s)	4	4	4	4	4
Vehicle Extension (s)	3	3	3	3	3
Minimum Gap (s)	3	3	3	3	3
Time Before Reduce (s)	0	0	0	0	0
Time To Reduce (s)	0	0	0	0	0
Walk Time (s)	7		7		7
Flash Dont Walk (s)	25		11		11
Dual Entry	Yes	No	Yes	No	Yes
Inhibit Max	Yes	Yes	Yes	Yes	Yes
Start Time (s)	55	97	0	97	0
End Time (s)	97	0	55	0	55
Yield/Force Off (s)	92	115	50	115	50
Yield/Force Off 170(s)	67	115	39	115	39
Local Start Time (s)	55	97	0	97	0
Local Yield (s)	92	115	50	115	50
Local Yield 170(s)	67	115	39	115	39

Intersection Summary

Cycle Length	120
Control Type	Actuated-Coordinated
Natural Cycle	75
Offset: 0 (0%), Referenced to phase 4:EBT, Start of Green	

Splits and Phases: 14: Transit Blvd & Unser Blvd

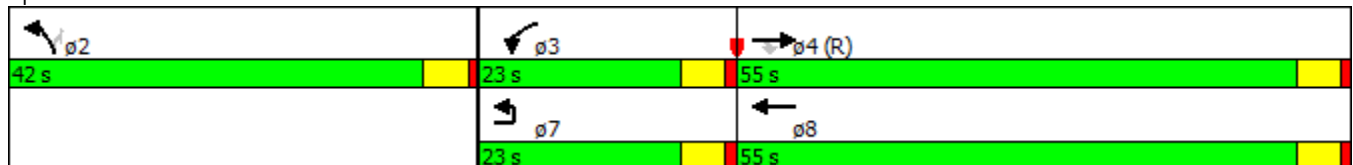

Timing Report, Sorted By Phase
11: Universe & Paseo del Norte

Scheme C -- Year 2035 PM

6/1/2013



Phase Number	1	2	3	4	5	6	7	8
Movement	SBL	NBT	WBL	EBT	NBL	SBT	EBL	WBT
Lead/Lag	Lead	Lag	Lead	Lag	Lead	Lag	Lag	Lead
Lead-Lag Optimize	Yes	Yes	Yes	Yes	Yes	Yes	Yes	Yes
Recall Mode	None	None	None	None	None	None	None	C-Max
Maximum Split (s)	11.5	42	11.5	55	11.5	42	11.5	55
Maximum Split (%)	9.6%	35.0%	9.6%	45.8%	9.6%	35.0%	9.6%	45.8%
Minimum Split (s)	9	42	9	35	9	42	9	35
Yellow Time (s)	3.5	4	3.5	4	3.5	4	3.5	4
All-Red Time (s)	1	1	1	1	1	1	1	1
Minimum Initial (s)	4	4	4	4	4	4	4	4
Vehicle Extension (s)	3	3	3	3	3	3	3	3
Minimum Gap (s)	3	3	3	3	3	3	3	3
Time Before Reduce (s)	0	0	0	0	0	0	0	0
Time To Reduce (s)	0	0	0	0	0	0	0	0
Walk Time (s)		7		7		7		7
Flash Dont Walk (s)		30		23		30		23
Dual Entry	No	Yes	No	Yes	No	Yes	No	Yes
Inhibit Max	Yes	Yes	Yes	Yes	Yes	Yes	Yes	Yes
Start Time (s)	6.5	18	60	71.5	6.5	18	115	60
End Time (s)	18	60	71.5	6.5	18	60	6.5	115
Yield/Force Off (s)	13.5	55	67	1.5	13.5	55	2	110
Yield/Force Off 170(s)	13.5	25	67	98.5	13.5	25	2	87
Local Start Time (s)	66.5	78	0	11.5	66.5	78	55	0
Local Yield (s)	73.5	115	7	61.5	73.5	115	62	50
Local Yield 170(s)	73.5	85	7	38.5	73.5	85	62	27

Intersection Summary

Cycle Length	120
Control Type	Actuated-Coordinated
Natural Cycle	115
Offset: 60 (50%), Referenced to phase 8:WBT, Start of Green	

Splits and Phases: 11: Universe & Paseo del Norte

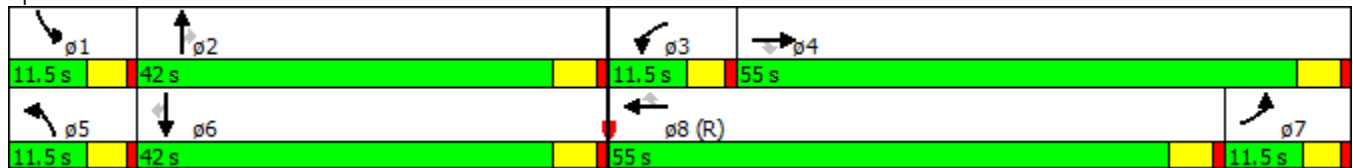

Timing Report, Sorted By Phase
12: Unser Blvd & Paseo del Norte

Scheme C -- Year 2035 PM

6/1/2013

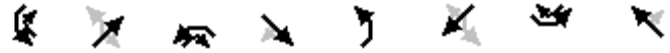

Phase Number	1	2	3	4	5	6	7	8
Movement	SWL	NETL	NWL	SET	NEL	SWTL	SEL	NWT
Lead/Lag	Lead	Lag	Lead	Lag	Lead	Lag	Lead	Lag
Lead-Lag Optimize	Yes	Yes	Yes	Yes	Yes	Yes	Yes	Yes
Recall Mode	None	None	None	Max	None	None	None	C-Max
Maximum Split (s)	13	42	15	50	13	42	15	50
Maximum Split (%)	10.8%	35.0%	12.5%	41.7%	10.8%	35.0%	12.5%	41.7%
Minimum Split (s)	9	42	9	41	9	42	9	41
Yellow Time (s)	4	4	4	4	4	4	4	4
All-Red Time (s)	1	1	1	1	1	1	1	1
Minimum Initial (s)	4	4	4	4	4	4	4	4
Vehicle Extension (s)	3	3	3	3	3	3	3	3
Minimum Gap (s)	3	3	3	3	3	3	3	3
Time Before Reduce (s)	0	0	0	0	0	0	0	0
Time To Reduce (s)	0	0	0	0	0	0	0	0
Walk Time (s)		7		7		7		7
Flash Dont Walk (s)		30		29		30		29
Dual Entry	No	Yes	No	Yes	No	Yes	No	Yes
Inhibit Max	Yes	Yes	Yes	Yes	Yes	Yes	Yes	Yes
Start Time (s)	50	63	105	0	50	63	105	0
End Time (s)	63	105	0	50	63	105	0	50
Yield/Force Off (s)	58	100	115	45	58	100	115	45
Yield/Force Off 170(s)	58	70	115	16	58	70	115	16
Local Start Time (s)	50	63	105	0	50	63	105	0
Local Yield (s)	58	100	115	45	58	100	115	45
Local Yield 170(s)	58	70	115	16	58	70	115	16

Intersection Summary

Cycle Length	120
Control Type	Actuated-Coordinated
Natural Cycle	125
Offset: 0 (0%), Referenced to phase 8:NWT, Start of Green, Master Intersection	

Splits and Phases: 12: Unser Blvd & Paseo del Norte

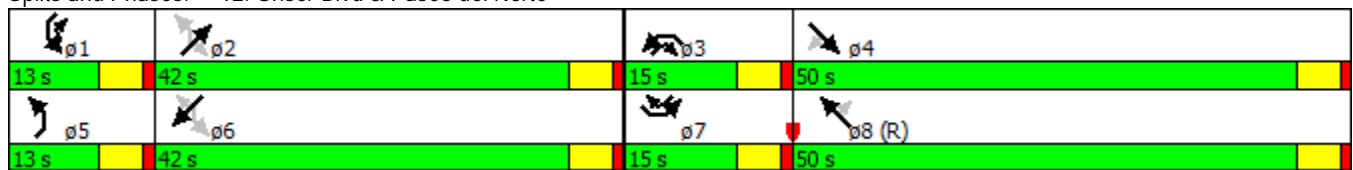

Timing Report, Sorted By Phase
 13: Kimmick Rd & Paseo del Norte

Scheme C -- Year 2035 PM

6/1/2013



Phase Number	1	2	3	4	5	6	7	8
Movement	SBL	NBTL	WBL	EBT	NBL	SBTL	EBL	WBT
Lead/Lag	Lead	Lag	Lead	Lag	Lead	Lag	Lead	Lag
Lead-Lag Optimize	Yes	Yes			Yes	Yes	Yes	
Recall Mode	None	None	None	C-Min	None	None	None	C-Max
Maximum Split (s)	12	42	15	51	12	42	15	51
Maximum Split (%)	10.0%	35.0%	12.5%	42.5%	10.0%	35.0%	12.5%	42.5%
Minimum Split (s)	9	42	9.5	23	9	42	9.5	23
Yellow Time (s)	4	4	4	4	4	4	4	4
All-Red Time (s)	1	1	1	1	1	1	1	1
Minimum Initial (s)	4	4	4	4	4	4	4	4
Vehicle Extension (s)	3	3	3	3	3	3	3	3
Minimum Gap (s)	3	3	3	3	3	3	3	3
Time Before Reduce (s)	0	0	0	0	0	0	0	0
Time To Reduce (s)	0	0	0	0	0	0	0	0
Walk Time (s)		7		7		7		7
Flash Dont Walk (s)		30		11		30		11
Dual Entry	No	Yes	No	Yes	No	Yes	No	Yes
Inhibit Max	Yes	Yes	Yes	Yes	Yes	Yes	Yes	Yes
Start Time (s)	111	3	45	60	111	3	45	60
End Time (s)	3	45	60	111	3	45	60	111
Yield/Force Off (s)	118	40	55	106	118	40	55	106
Yield/Force Off 170(s)	118	10	55	95	118	10	55	95
Local Start Time (s)	51	63	105	0	51	63	105	0
Local Yield (s)	58	100	115	46	58	100	115	46
Local Yield 170(s)	58	70	115	35	58	70	115	35

Intersection Summary

Cycle Length	120
Control Type	Actuated-Coordinated
Natural Cycle	135
Offset: 60 (50%), Referenced to phase 4:EBT and 8:WBT, Start of Green	

Splits and Phases: 13: Kimmick Rd & Paseo del Norte

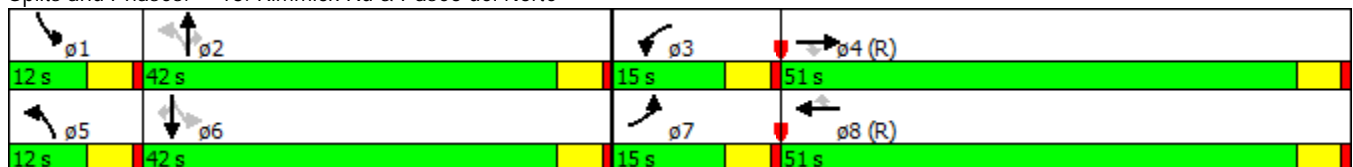

Timing Report, Sorted By Phase
 14: Transit Blvd & Unser Blvd



Phase Number	2	3	4	8
Movement	NBL	WBL	EBT	WBT
Lead/Lag		Lead	Lag	
Lead-Lag Optimize		Yes	Yes	
Recall Mode	Max	None	C-Max	None
Maximum Split (s)	42	23	55	55
Maximum Split (%)	35.0%	19.2%	45.8%	45.8%
Minimum Split (s)	37	9.5	23	23
Yellow Time (s)	4	4	4	4
All-Red Time (s)	1	1	1	1
Minimum Initial (s)	4	4	4	4
Vehicle Extension (s)	3	3	3	3
Minimum Gap (s)	3	3	3	3
Time Before Reduce (s)	0	0	0	0
Time To Reduce (s)	0	0	0	0
Walk Time (s)	7		7	7
Flash Dont Walk (s)	25		11	11
Dual Entry	Yes	No	Yes	Yes
Inhibit Max	Yes	Yes	Yes	Yes
Start Time (s)	55	97	0	97
End Time (s)	97	0	55	55
Yield/Force Off (s)	92	115	50	50
Yield/Force Off 170(s)	67	115	39	39
Local Start Time (s)	55	97	0	97
Local Yield (s)	92	115	50	50
Local Yield 170(s)	67	115	39	39

Intersection Summary

Cycle Length	120
Control Type	Actuated-Coordinated
Natural Cycle	75
Offset: 0 (0%), Referenced to phase 4:EBT, Start of Green	

Splits and Phases: 14: Transit Blvd & Unser Blvd

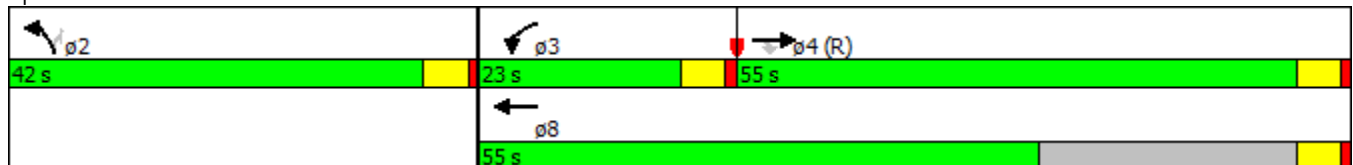

Timing Report, Sorted By Phase
 101: Paseo del Norte & Loop Rd W/Loop Rd N

Scheme C -- Year 2035 PM
 6/1/2013



Phase Number	2	3	4	6	7	8
Movement	EBTL	NWL	SET	WBTL	SEL	NWT
Lead/Lag		Lead	Lag		Lag	Lead
Lead-Lag Optimize		Yes	Yes		Yes	Yes
Recall Mode	None	None	Min	None	None	C-Max
Maximum Split (s)	42	16	62	42	16	62
Maximum Split (%)	35.0%	13.3%	51.7%	35.0%	13.3%	51.7%
Minimum Split (s)	27	9	27	42	9	42
Yellow Time (s)	4	4	4	4	4	4
All-Red Time (s)	1	1	1	1	1	1
Minimum Initial (s)	4	4	4	4	4	4
Vehicle Extension (s)	3	3	3	3	3	3
Minimum Gap (s)	3	3	3	3	3	3
Time Before Reduce (s)	0	0	0	0	0	0
Time To Reduce (s)	0	0	0	0	0	0
Walk Time (s)	7		7	7		7
Flash Dont Walk (s)	15		15	30		30
Dual Entry	Yes	No	Yes	Yes	No	Yes
Inhibit Max	Yes	Yes	Yes	Yes	Yes	Yes
Start Time (s)	98	20	36	98	82	20
End Time (s)	20	36	98	20	98	82
Yield/Force Off (s)	15	31	93	15	93	77
Yield/Force Off 170(s)	0	31	93	105	93	47
Local Start Time (s)	78	0	16	78	62	0
Local Yield (s)	115	11	73	115	73	57
Local Yield 170(s)	100	11	73	85	73	27

Intersection Summary

Cycle Length	120
Control Type	Actuated-Coordinated
Natural Cycle	105
Offset: 20 (17%), Referenced to phase 8:NWT, Start of Green	

Splits and Phases: 101: Paseo del Norte & Loop Rd W/Loop Rd N

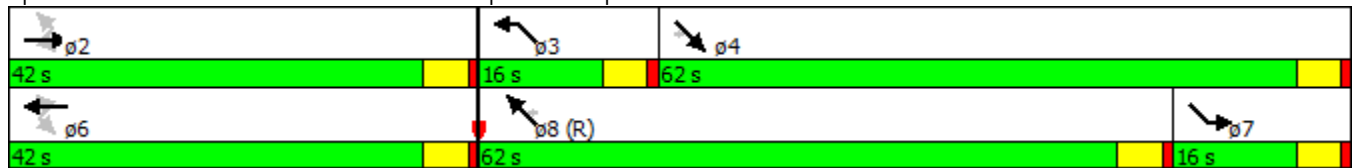

Timing Report, Sorted By Phase
102: Unser Blvd & Loop Rd N



Phase Number	2	4	6	8
Movement	NWTL	NETL	SETL	SWTL
Lead/Lag				
Lead-Lag Optimize				
Recall Mode	None	C-Max	None	C-Max
Maximum Split (s)	42	78	42	78
Maximum Split (%)	35.0%	65.0%	35.0%	65.0%
Minimum Split (s)	23	23	23	23
Yellow Time (s)	4	4	4	4
All-Red Time (s)	1	1	1	1
Minimum Initial (s)	4	4	4	4
Vehicle Extension (s)	3	3	3	3
Minimum Gap (s)	3	3	3	3
Time Before Reduce (s)	0	0	0	0
Time To Reduce (s)	0	0	0	0
Walk Time (s)	7	7	7	7
Flash Dont Walk (s)	11	11	11	11
Dual Entry	Yes	Yes	Yes	Yes
Inhibit Max	Yes	Yes	Yes	Yes
Start Time (s)	18	60	18	60
End Time (s)	60	18	60	18
Yield/Force Off (s)	55	13	55	13
Yield/Force Off 170(s)	44	2	44	2
Local Start Time (s)	78	0	78	0
Local Yield (s)	115	73	115	73
Local Yield 170(s)	104	62	104	62

Intersection Summary

Cycle Length	120
Control Type	Actuated-Coordinated
Natural Cycle	50
Offset: 60 (50%), Referenced to phase 4:NETL and 8:SWTL, Start of Green	

Splits and Phases: 102: Unser Blvd & Loop Rd N

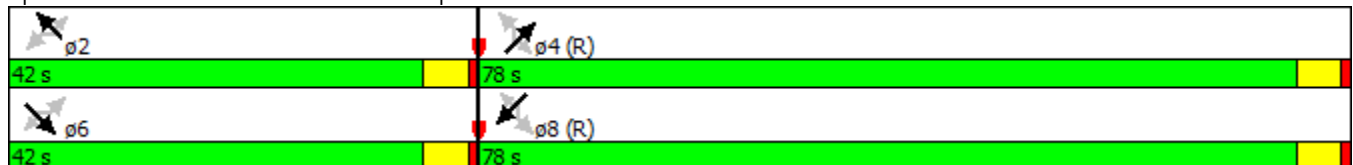

Timing Report, Sorted By Phase
 103: Avenita de Jaimito/Transit Blvd & Paseo del Norte

Scheme C -- Year 2035 PM
 6/1/2013



Phase Number	2	3	4	6	7	8
Movement	NETL	NWL	SET	SWTL	SEL	NWT
Lead/Lag		Lead	Lag		Lag	Lead
Lead-Lag Optimize		Yes	Yes			
Recall Mode	None	None	Max	None	None	C-Max
Maximum Split (s)	42	18	60	42	18	60
Maximum Split (%)	35.0%	15.0%	50.0%	35.0%	15.0%	50.0%
Minimum Split (s)	42	9	27	42	9	27
Yellow Time (s)	4	4	4	4	4	4
All-Red Time (s)	1	1	1	1	1	1
Minimum Initial (s)	4	4	4	4	4	4
Vehicle Extension (s)	3	3	3	3	3	3
Minimum Gap (s)	3	3	3	3	3	3
Time Before Reduce (s)	0	0	0	0	0	0
Time To Reduce (s)	0	0	0	0	0	0
Walk Time (s)	7		7	7		7
Flash Dont Walk (s)	30		15	30		15
Dual Entry	Yes	No	Yes	Yes	No	Yes
Inhibit Max	Yes	Yes	Yes	Yes	Yes	Yes
Start Time (s)	98	20	38	98	80	20
End Time (s)	20	38	98	20	98	80
Yield/Force Off (s)	15	33	93	15	93	75
Yield/Force Off 170(s)	105	33	78	105	93	60
Local Start Time (s)	78	0	18	78	60	0
Local Yield (s)	115	13	73	115	73	55
Local Yield 170(s)	85	13	58	85	73	40

Intersection Summary

Cycle Length	120
Control Type	Actuated-Coordinated
Natural Cycle	110
Offset: 20 (17%), Referenced to phase 8:NWT, Start of Green	

Splits and Phases: 103: Avenita de Jaimito/Transit Blvd & Paseo del Norte

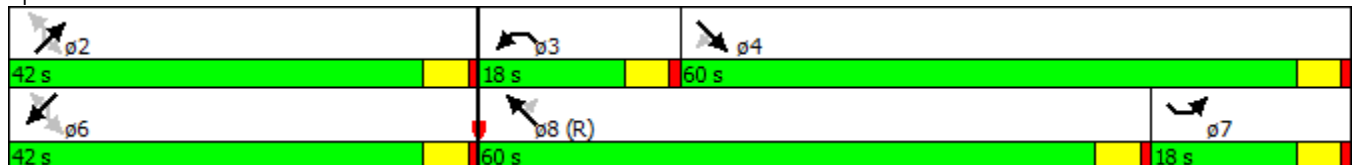

Timing Report, Sorted By Phase
 104: Unser Blvd & Loop Rd W/Avenida de Jaimito

Scheme C -- Year 2035 PM

6/1/2013



Phase Number	2	4	6	8
Movement	NBTL	EBTL	SBTL	WBTL
Lead/Lag				
Lead-Lag Optimize				
Recall Mode	None	C-Max	None	C-Max
Maximum Split (s)	82	38	82	38
Maximum Split (%)	68.3%	31.7%	68.3%	31.7%
Minimum Split (s)	23	23	23	23
Yellow Time (s)	4	4	4	4
All-Red Time (s)	1	1	1	1
Minimum Initial (s)	4	4	4	4
Vehicle Extension (s)	3	3	3	3
Minimum Gap (s)	3	3	3	3
Time Before Reduce (s)	0	0	0	0
Time To Reduce (s)	0	0	0	0
Walk Time (s)	7	7	7	7
Flash Dont Walk (s)	11	11	11	11
Dual Entry	Yes	Yes	Yes	Yes
Inhibit Max	Yes	Yes	Yes	Yes
Start Time (s)	38	0	38	0
End Time (s)	0	38	0	38
Yield/Force Off (s)	115	33	115	33
Yield/Force Off 170(s)	104	22	104	22
Local Start Time (s)	38	0	38	0
Local Yield (s)	115	33	115	33
Local Yield 170(s)	104	22	104	22

Intersection Summary

Cycle Length	120
Control Type	Actuated-Coordinated
Natural Cycle	50
Offset: 0 (0%), Referenced to phase 4:EBTL and 8:WBTL, Start of Green	

Splits and Phases: 104: Unser Blvd & Loop Rd W/Avenida de Jaimito



Timing Report, Sorted By Phase
11: Universe & Paseo del Norte

Scheme D -- Year 2035 PM

6/6/2013



Phase Number	1	2	3	4	5	6	7	8
Movement	SBL	NBT	WBL	EBT	NBL	SBT	EBL	WBT
Lead/Lag	Lead	Lag	Lead	Lag	Lead	Lag	Lag	Lead
Lead-Lag Optimize	Yes	Yes	Yes	Yes	Yes	Yes	Yes	Yes
Recall Mode	None	None	None	None	None	None	None	C-Max
Maximum Split (s)	11.5	42	11.5	55	11.5	42	11.5	55
Maximum Split (%)	9.6%	35.0%	9.6%	45.8%	9.6%	35.0%	9.6%	45.8%
Minimum Split (s)	9	42	9	35	9	42	9	35
Yellow Time (s)	3.5	4	3.5	4	3.5	4	3.5	4
All-Red Time (s)	1	1	1	1	1	1	1	1
Minimum Initial (s)	4	4	4	4	4	4	4	4
Vehicle Extension (s)	3	3	3	3	3	3	3	3
Minimum Gap (s)	3	3	3	3	3	3	3	3
Time Before Reduce (s)	0	0	0	0	0	0	0	0
Time To Reduce (s)	0	0	0	0	0	0	0	0
Walk Time (s)		7		7		7		7
Flash Dont Walk (s)		30		23		30		23
Dual Entry	No	Yes	No	Yes	No	Yes	No	Yes
Inhibit Max	Yes	Yes	Yes	Yes	Yes	Yes	Yes	Yes
Start Time (s)	6.5	18	60	71.5	6.5	18	115	60
End Time (s)	18	60	71.5	6.5	18	60	6.5	115
Yield/Force Off (s)	13.5	55	67	1.5	13.5	55	2	110
Yield/Force Off 170(s)	13.5	25	67	98.5	13.5	25	2	87
Local Start Time (s)	66.5	78	0	11.5	66.5	78	55	0
Local Yield (s)	73.5	115	7	61.5	73.5	115	62	50
Local Yield 170(s)	73.5	85	7	38.5	73.5	85	62	27

Intersection Summary

Cycle Length	120
Control Type	Actuated-Coordinated
Natural Cycle	115
Offset: 60 (50%), Referenced to phase 8:WBT, Start of Green	

Splits and Phases: 11: Universe & Paseo del Norte

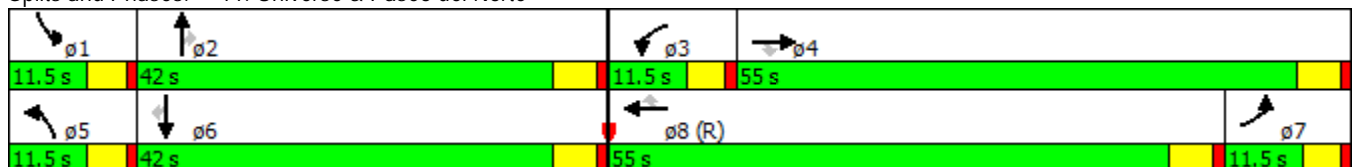

Timing Report, Sorted By Phase
12: Unser Blvd & Paseo del Norte

Scheme D -- Year 2035 PM

6/6/2013



Phase Number	1	2	3	4	5	6	7	8
Movement	SWL	NETL	NWL	SET	NEL	SWTL	SEL	NWT
Lead/Lag	Lead	Lag	Lead	Lag	Lead	Lag	Lead	Lag
Lead-Lag Optimize	Yes	Yes	Yes	Yes	Yes	Yes	Yes	Yes
Recall Mode	None	None	None	Max	None	None	None	C-Max
Maximum Split (s)	13	42	15	50	13	42	15	50
Maximum Split (%)	10.8%	35.0%	12.5%	41.7%	10.8%	35.0%	12.5%	41.7%
Minimum Split (s)	9	42	9	41	9	42	9	41
Yellow Time (s)	4	4	4	4	4	4	4	4
All-Red Time (s)	1	1	1	1	1	1	1	1
Minimum Initial (s)	4	4	4	4	4	4	4	4
Vehicle Extension (s)	3	3	3	3	3	3	3	3
Minimum Gap (s)	3	3	3	3	3	3	3	3
Time Before Reduce (s)	0	0	0	0	0	0	0	0
Time To Reduce (s)	0	0	0	0	0	0	0	0
Walk Time (s)		7		7		7		7
Flash Dont Walk (s)		30		29		30		29
Dual Entry	No	Yes	No	Yes	No	Yes	No	Yes
Inhibit Max	Yes	Yes	Yes	Yes	Yes	Yes	Yes	Yes
Start Time (s)	50	63	105	0	50	63	105	0
End Time (s)	63	105	0	50	63	105	0	50
Yield/Force Off (s)	58	100	115	45	58	100	115	45
Yield/Force Off 170(s)	58	70	115	16	58	70	115	16
Local Start Time (s)	50	63	105	0	50	63	105	0
Local Yield (s)	58	100	115	45	58	100	115	45
Local Yield 170(s)	58	70	115	16	58	70	115	16

Intersection Summary

Cycle Length	120
Control Type	Actuated-Coordinated
Natural Cycle	125
Offset: 0 (0%), Referenced to phase 8:NWT, Start of Green, Master Intersection	

Splits and Phases: 12: Unser Blvd & Paseo del Norte

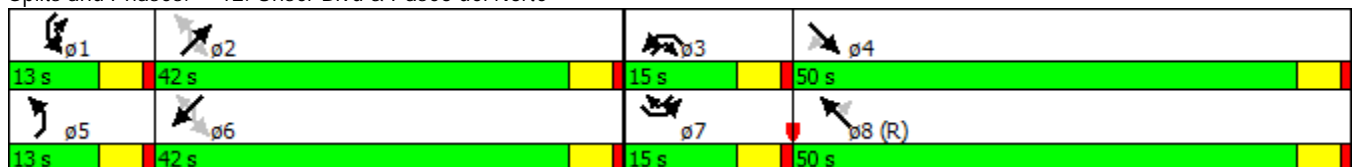

Timing Report, Sorted By Phase
 13: Kimmick Rd & Paseo del Norte

Scheme D -- Year 2035 PM

6/6/2013

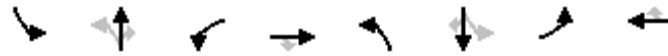

Phase Number	1	2	3	4	5	6	7	8
Movement	SBL	NBTL	WBL	EBT	NBL	SBTL	EBL	WBT
Lead/Lag	Lead	Lag	Lead	Lag	Lead	Lag	Lead	Lag
Lead-Lag Optimize	Yes	Yes			Yes	Yes	Yes	
Recall Mode	None	None	None	C-Min	None	None	None	C-Max
Maximum Split (s)	10	42	17	51	10	42	17	51
Maximum Split (%)	8.3%	35.0%	14.2%	42.5%	8.3%	35.0%	14.2%	42.5%
Minimum Split (s)	9	42	9.5	23	9	42	9.5	23
Yellow Time (s)	4	4	4	4	4	4	4	4
All-Red Time (s)	1	1	1	1	1	1	1	1
Minimum Initial (s)	4	4	4	4	4	4	4	4
Vehicle Extension (s)	3	3	3	3	3	3	3	3
Minimum Gap (s)	3	3	3	3	3	3	3	3
Time Before Reduce (s)	0	0	0	0	0	0	0	0
Time To Reduce (s)	0	0	0	0	0	0	0	0
Walk Time (s)		7		7		7		7
Flash Dont Walk (s)		30		11		30		11
Dual Entry	No	Yes	No	Yes	No	Yes	No	Yes
Inhibit Max	Yes	Yes	Yes	Yes	Yes	Yes	Yes	Yes
Start Time (s)	111	1	43	60	111	1	43	60
End Time (s)	1	43	60	111	1	43	60	111
Yield/Force Off (s)	116	38	55	106	116	38	55	106
Yield/Force Off 170(s)	116	8	55	95	116	8	55	95
Local Start Time (s)	51	61	103	0	51	61	103	0
Local Yield (s)	56	98	115	46	56	98	115	46
Local Yield 170(s)	56	68	115	35	56	68	115	35

Intersection Summary

Cycle Length	120
Control Type	Actuated-Coordinated
Natural Cycle	135
Offset: 60 (50%), Referenced to phase 4:EBT and 8:WBT, Start of Green	

Splits and Phases: 13: Kimmick Rd & Paseo del Norte

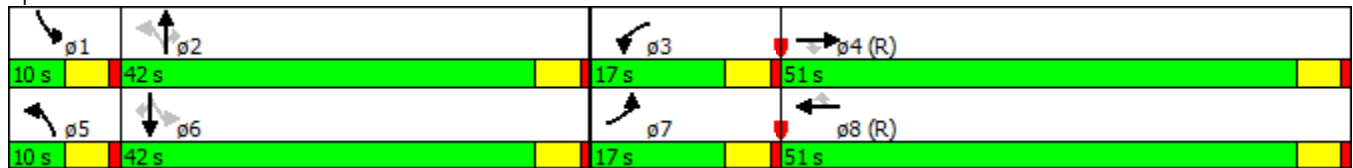

Timing Report, Sorted By Phase
 14: Transit Blvd & Unser Blvd



Phase Number	2	3	4	8
Movement	NBL	WBL	EBT	WBT
Lead/Lag		Lead	Lag	
Lead-Lag Optimize		Yes	Yes	
Recall Mode	Max	None	C-Max	None
Maximum Split (s)	42	23	55	55
Maximum Split (%)	35.0%	19.2%	45.8%	45.8%
Minimum Split (s)	37	9.5	23	23
Yellow Time (s)	4	4	4	4
All-Red Time (s)	1	1	1	1
Minimum Initial (s)	4	4	4	4
Vehicle Extension (s)	3	3	3	3
Minimum Gap (s)	3	3	3	3
Time Before Reduce (s)	0	0	0	0
Time To Reduce (s)	0	0	0	0
Walk Time (s)	7		7	7
Flash Dont Walk (s)	25		11	11
Dual Entry	Yes	No	Yes	Yes
Inhibit Max	Yes	Yes	Yes	Yes
Start Time (s)	55	97	0	97
End Time (s)	97	0	55	55
Yield/Force Off (s)	92	115	50	50
Yield/Force Off 170(s)	67	115	39	39
Local Start Time (s)	55	97	0	97
Local Yield (s)	92	115	50	50
Local Yield 170(s)	67	115	39	39

Intersection Summary

Cycle Length	120
Control Type	Actuated-Coordinated
Natural Cycle	75
Offset: 0 (0%), Referenced to phase 4:EBT, Start of Green	

Splits and Phases: 14: Transit Blvd & Unser Blvd

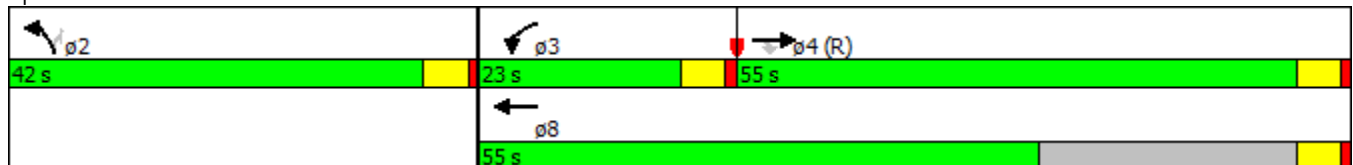

Timing Report, Sorted By Phase
 101: Paseo del Norte & Loop Rd W

Scheme D -- Year 2035 PM
 6/6/2013



Phase Number	2	3	4	6	7	8
Movement	EBTL	NWL	SET	WBTL	SEL	NWT
Lead/Lag		Lead	Lag		Lag	Lead
Lead-Lag Optimize		Yes	Yes		Yes	Yes
Recall Mode	None	None	Min	None	None	C-Max
Maximum Split (s)	42	16	62	42	16	62
Maximum Split (%)	35.0%	13.3%	51.7%	35.0%	13.3%	51.7%
Minimum Split (s)	27	9	27	42	9	42
Yellow Time (s)	4	4	4	4	4	4
All-Red Time (s)	1	1	1	1	1	1
Minimum Initial (s)	4	4	4	4	4	4
Vehicle Extension (s)	3	3	3	3	3	3
Minimum Gap (s)	3	3	3	3	3	3
Time Before Reduce (s)	0	0	0	0	0	0
Time To Reduce (s)	0	0	0	0	0	0
Walk Time (s)	7		7	7		7
Flash Dont Walk (s)	15		15	30		30
Dual Entry	Yes	No	Yes	Yes	No	Yes
Inhibit Max	Yes	Yes	Yes	Yes	Yes	Yes
Start Time (s)	98	20	36	98	82	20
End Time (s)	20	36	98	20	98	82
Yield/Force Off (s)	15	31	93	15	93	77
Yield/Force Off 170(s)	0	31	93	105	93	47
Local Start Time (s)	78	0	16	78	62	0
Local Yield (s)	115	11	73	115	73	57
Local Yield 170(s)	100	11	73	85	73	27

Intersection Summary

Cycle Length	120
Control Type	Actuated-Coordinated
Natural Cycle	105
Offset: 20 (17%), Referenced to phase 8:NWT, Start of Green	

Splits and Phases: 101: Paseo del Norte & Loop Rd W

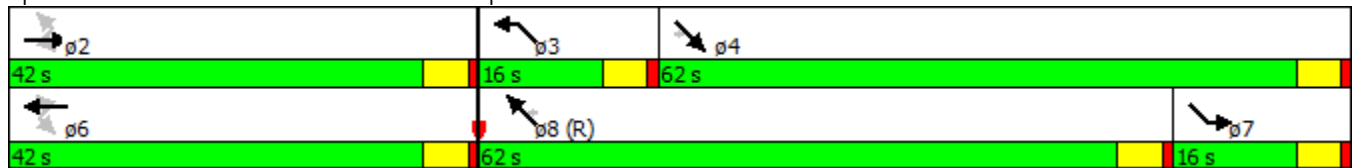

Timing Report, Sorted By Phase
 102: Unser Blvd & Loop Rd N



Phase Number	2	4	6	8
Movement	NWTL	NETL	SETL	SWTL
Lead/Lag				
Lead-Lag Optimize				
Recall Mode	None	C-Max	None	C-Max
Maximum Split (s)	42	78	42	78
Maximum Split (%)	35.0%	65.0%	35.0%	65.0%
Minimum Split (s)	23	23	23	23
Yellow Time (s)	4	4	4	4
All-Red Time (s)	1	1	1	1
Minimum Initial (s)	4	4	4	4
Vehicle Extension (s)	3	3	3	3
Minimum Gap (s)	3	3	3	3
Time Before Reduce (s)	0	0	0	0
Time To Reduce (s)	0	0	0	0
Walk Time (s)	7	7	7	7
Flash Dont Walk (s)	11	11	11	11
Dual Entry	Yes	Yes	Yes	Yes
Inhibit Max	Yes	Yes	Yes	Yes
Start Time (s)	18	60	18	60
End Time (s)	60	18	60	18
Yield/Force Off (s)	55	13	55	13
Yield/Force Off 170(s)	44	2	44	2
Local Start Time (s)	78	0	78	0
Local Yield (s)	115	73	115	73
Local Yield 170(s)	104	62	104	62

Intersection Summary

Cycle Length	120
Control Type	Actuated-Coordinated
Natural Cycle	50
Offset: 60 (50%), Referenced to phase 4:NETL and 8:SWTL, Start of Green	

Splits and Phases: 102: Unser Blvd & Loop Rd N

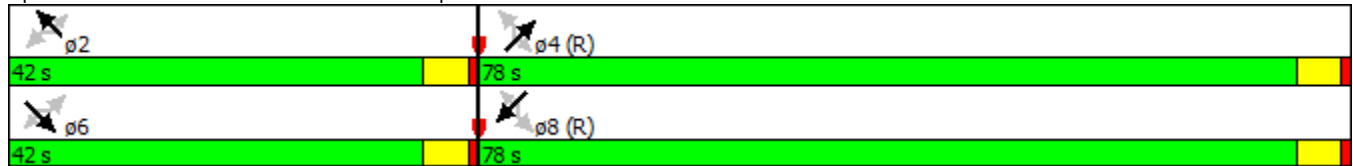

Timing Report, Sorted By Phase
 103: Loop Rd E/Loop Rd East & Paseo del Norte

Scheme D -- Year 2035 PM
 6/6/2013



Phase Number	2	3	4	6	7	8
Movement	NETL	NWL	SET	SWTL	SEL	NWT
Lead/Lag		Lead	Lag		Lag	Lead
Lead-Lag Optimize		Yes	Yes			
Recall Mode	None	None	Max	None	None	C-Max
Maximum Split (s)	42	18	60	42	18	60
Maximum Split (%)	35.0%	15.0%	50.0%	35.0%	15.0%	50.0%
Minimum Split (s)	42	9	27	42	9	27
Yellow Time (s)	4	4	4	4	4	4
All-Red Time (s)	1	1	1	1	1	1
Minimum Initial (s)	4	4	4	4	4	4
Vehicle Extension (s)	3	3	3	3	3	3
Minimum Gap (s)	3	3	3	3	3	3
Time Before Reduce (s)	0	0	0	0	0	0
Time To Reduce (s)	0	0	0	0	0	0
Walk Time (s)	7		7	7		7
Flash Dont Walk (s)	30		15	30		15
Dual Entry	Yes	No	Yes	Yes	No	Yes
Inhibit Max	Yes	Yes	Yes	Yes	Yes	Yes
Start Time (s)	88	10	28	88	70	10
End Time (s)	10	28	88	10	88	70
Yield/Force Off (s)	5	23	83	5	83	65
Yield/Force Off 170(s)	95	23	68	95	83	50
Local Start Time (s)	78	0	18	78	60	0
Local Yield (s)	115	13	73	115	73	55
Local Yield 170(s)	85	13	58	85	73	40

Intersection Summary

Cycle Length	120
Control Type	Actuated-Coordinated
Natural Cycle	110
Offset: 10 (8%), Referenced to phase 8:NWT, Start of Green	

Splits and Phases: 103: Loop Rd E/Loop Rd East & Paseo del Norte

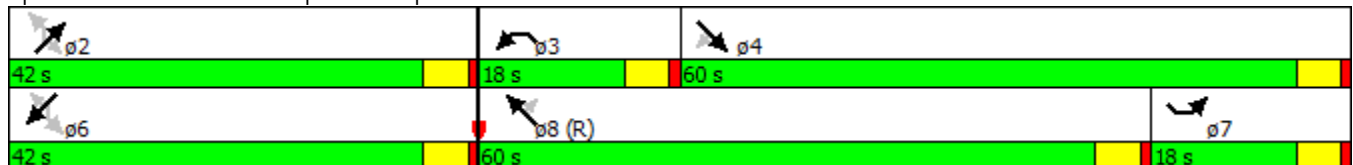

Timing Report, Sorted By Phase
104: Unser Blvd & Loop Rd S



Phase Number	2	4	6	8
Movement	NBTL	EBTL	SBTL	WBTL
Lead/Lag				
Lead-Lag Optimize				
Recall Mode	None	C-Max	None	C-Max
Maximum Split (s)	82	38	82	38
Maximum Split (%)	68.3%	31.7%	68.3%	31.7%
Minimum Split (s)	23	23	23	23
Yellow Time (s)	4	4	4	4
All-Red Time (s)	1	1	1	1
Minimum Initial (s)	4	4	4	4
Vehicle Extension (s)	3	3	3	3
Minimum Gap (s)	3	3	3	3
Time Before Reduce (s)	0	0	0	0
Time To Reduce (s)	0	0	0	0
Walk Time (s)	7	7	7	7
Flash Dont Walk (s)	11	11	11	11
Dual Entry	Yes	Yes	Yes	Yes
Inhibit Max	Yes	Yes	Yes	Yes
Start Time (s)	38	0	38	0
End Time (s)	0	38	0	38
Yield/Force Off (s)	115	33	115	33
Yield/Force Off 170(s)	104	22	104	22
Local Start Time (s)	38	0	38	0
Local Yield (s)	115	33	115	33
Local Yield 170(s)	104	22	104	22

Intersection Summary

Cycle Length	120
Control Type	Actuated-Coordinated
Natural Cycle	50
Offset: 0 (0%), Referenced to phase 4:EBTL and 8:WBTL, Start of Green	

Splits and Phases: 104: Unser Blvd & Loop Rd S



Timing Report, Sorted By Phase
 105: Paseo del Norte & Transit Blvd

Scheme D -- Year 2035 PM

6/6/2013



Phase Number	4	6	8
Movement	EBTL	SBL	WBT
Lead/Lag			
Lead-Lag Optimize			
Recall Mode	None	None	C-Max
Maximum Split (s)	78	42	78
Maximum Split (%)	65.0%	35.0%	65.0%
Minimum Split (s)	23	23	23
Yellow Time (s)	4	4	4
All-Red Time (s)	1	1	1
Minimum Initial (s)	4	4	4
Vehicle Extension (s)	3	3	3
Minimum Gap (s)	3	3	3
Time Before Reduce (s)	0	0	0
Time To Reduce (s)	0	0	0
Walk Time (s)	7	7	7
Flash Dont Walk (s)	11	11	11
Dual Entry	Yes	Yes	Yes
Inhibit Max	Yes	Yes	Yes
Start Time (s)	30	108	30
End Time (s)	108	30	108
Yield/Force Off (s)	103	25	103
Yield/Force Off 170(s)	92	14	92
Local Start Time (s)	0	78	0
Local Yield (s)	73	115	73
Local Yield 170(s)	62	104	62

Intersection Summary

Cycle Length	120
Control Type	Actuated-Coordinated
Natural Cycle	60
Offset: 30 (25%), Referenced to phase 8:WBT, Start of Green	

Splits and Phases: 105: Paseo del Norte & Transit Blvd

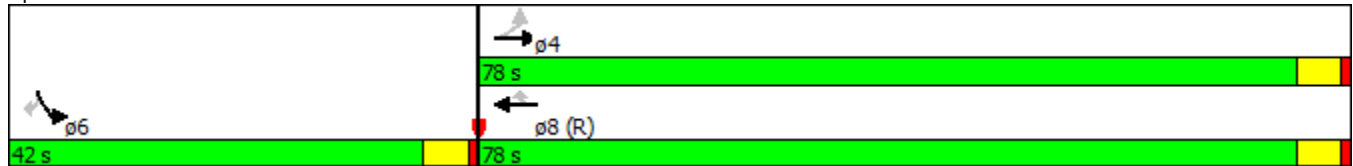

Appendix C

Arterial Level of Service

Arterial Level of Service: NW Paseo del Norte

Cross Street	Arterial Class	Flow Speed	Running Time	Signal Delay	Travel Time (s)	Dist (mi)	Arterial Speed	Arterial LOS
	II	45	11.0	2.9	13.9	0.10	26.2	C
Kimmick Rd	II	45	51.7	29.9	81.6	0.65	28.5	B
Loop Rd East	II	45	50.4	30.2	80.6	0.63	28.1	B
Unser Blvd	II	45	24.4	136.7	161.1	0.22	5.0	F
Loop Rd N	II	45	27.8	5.7	33.5	0.28	30.1	B
Universe	II	45	29.0	13.5	42.5	0.29	24.8	C
Total	II		194.3	218.9	413.2	2.17	18.9	D

Arterial Level of Service: EB Paseo del Norte

Cross Street	Arterial Class	Flow Speed	Running Time	Signal Delay	Travel Time (s)	Dist (mi)	Arterial Speed	Arterial LOS
Universe	II	45	44.6	26.0	70.6	0.51	25.9	C
Loop Rd W	II	45	29.0	46.0	75.0	0.29	14.0	E
Unser Blvd	II	45	27.8	65.2	93.0	0.28	10.9	F
Avenida de Jaimito	II	45	24.4	11.6	36.0	0.22	22.4	C
Kimmick Rd	II	45	50.4	21.7	72.1	0.63	31.4	B
	II	45	51.7	1.2	52.9	0.65	44.0	A
Total	II		227.9	171.7	399.6	2.58	23.2	C

Arterial Level of Service: NB Unser Blvd

Cross Street	Arterial Class	Flow Speed	Running Time	Signal Delay	Travel Time (s)	Dist (mi)	Arterial Speed	Arterial LOS
Rose Parks	II	45	3.8	24.9	28.7	0.03	4.4	F
Avenida de Jaimito	II	45	44.6	28.6	73.2	0.51	24.9	C
Paseo del Norte	II	45	24.3	30.6	54.9	0.22	14.6	E
Loop Rd N	II	45	24.4	1.2	25.6	0.22	31.5	B
Transit Blvd	II	40	26.7	15.6	42.3	0.24	20.6	D
Total	II		123.8	100.9	224.7	1.23	19.7	D

Arterial Level of Service: SB Unser Blvd

Cross Street	Arterial Class	Flow Speed	Running Time	Signal Delay	Travel Time (s)	Dist (mi)	Arterial Speed	Arterial LOS
Transit Blvd	II	45	10.3	12.6	22.9	0.09	14.9	E
Loop Rd N	II	44	25.2	5.1	30.3	0.24	28.8	B
Paseo del Norte	II	45	24.4	39.5	63.9	0.22	12.6	F
Loop Rd W	II	45	24.3	39.8	64.1	0.22	12.5	F
Rose Parks	II	45	44.6	20.0	64.6	0.51	28.3	B
Total	II		128.8	117.0	245.8	1.29	18.9	D

Arterial Level of Service: EB Paseo del Norte

Cross Street	Arterial Class	Flow Speed	Running Time	Signal Delay	Travel Time (s)	Dist (mi)	Arterial Speed	Arterial LOS
Universe	II	45	44.6	26.0	70.6	0.51	25.9	C
Unser Blvd	II	45	45.8	53.8	99.6	0.57	20.7	D
Kimmick Rd	II	45	43.0	24.0	67.0	0.49	26.2	C
	II	45	59.2	0.8	60.0	0.74	44.5	A
Total	II		192.6	104.6	297.2	2.31	28.0	C

Arterial Level of Service: WB Paseo del Norte

Cross Street	Arterial Class	Flow Speed	Running Time	Signal Delay	Travel Time (s)	Dist (mi)	Arterial Speed	Arterial LOS
	II	45	11.0	2.9	13.9	0.10	26.2	C
Kimmick Rd	II	45	59.2	114.2	173.4	0.74	15.4	E
Unser Blvd	II	45	28.2	150.8	179.0	0.28	5.7	F
Universe	II	45	45.8	10.7	56.5	0.57	36.5	A
Total	II		144.2	278.6	422.8	1.70	14.5	E

Arterial Level of Service: EB Unser Blvd

Cross Street	Arterial Class	Flow Speed	Running Time	Signal Delay	Travel Time (s)	Dist (mi)	Arterial Speed	Arterial LOS
Rose Parks	II	45	3.8	24.9	28.7	0.03	4.4	F
Paseo del Norte	II	45	31.9	49.8	81.7	0.32	14.2	E
Transit Blvd	II	43	39.8	15.2	55.0	0.44	28.6	B
Total	II		75.5	89.9	165.4	0.79	17.3	D

Arterial Level of Service: WB Unser Blvd

Cross Street	Arterial Class	Flow Speed	Running Time	Signal Delay	Travel Time (s)	Dist (mi)	Arterial Speed	Arterial LOS
Transit Blvd	II	45	42.9	25.4	68.3	0.47	24.9	C
Paseo del Norte	II	45	39.8	40.6	80.4	0.44	19.6	D
Rose Parks	II	45	36.5	20.0	56.5	0.39	24.8	C
Total	II		119.2	86.0	205.2	1.30	22.8	C

Arterial Level of Service: NW Paseo del Norte

Cross Street	Arterial Class	Flow Speed	Running Time	Signal Delay	Travel Time (s)	Dist (mi)	Arterial Speed	Arterial LOS
Transit Blvd	II	45	43.8	44.6	88.4	0.50	20.3	D
Unser Blvd	II	45	28.5	144.4	172.9	0.27	5.7	F
Loop Rd N	II	45	27.8	5.4	33.2	0.28	30.4	B
Universe	II	45	29.0	13.4	42.4	0.29	24.8	C
Total	II		129.1	207.8	336.9	1.35	14.4	E

Arterial Level of Service: SE Paseo del Norte

Cross Street	Arterial Class	Flow Speed	Running Time	Signal Delay	Travel Time (s)	Dist (mi)	Arterial Speed	Arterial LOS
Universe	II	45	44.6	26.0	70.6	0.51	25.9	C
Loop Rd W	II	45	29.0	46.0	75.0	0.29	14.0	E
Unser Blvd	II	45	27.8	65.2	93.0	0.28	10.9	F
Avenida de Jaimito	II	45	28.5	14.9	43.4	0.27	22.8	C
Total	II		129.9	152.1	282.0	1.35	17.3	D

Arterial Level of Service: NE Unser Blvd

Cross Street	Arterial Class	Flow Speed	Running Time	Signal Delay	Travel Time (s)	Dist (mi)	Arterial Speed	Arterial LOS
Avenida de Jaimito	II	45	36.5	28.6	65.1	0.39	21.5	D
Paseo del Norte	II	45	31.9	30.4	62.3	0.32	18.6	D
Loop Rd N	II	45	25.9	1.4	27.3	0.25	32.8	B
Total	II		94.3	60.4	154.7	0.96	22.3	C

Arterial Level of Service: SW Unser Blvd

Cross Street	Arterial Class	Flow Speed	Running Time	Signal Delay	Travel Time (s)	Dist (mi)	Arterial Speed	Arterial LOS
Loop Rd N	II	44	26.4	5.3	31.7	0.25	28.8	B
Paseo del Norte	II	45	25.9	39.9	65.8	0.25	13.6	E
Loop Rd W	II	45	31.9	48.4	80.3	0.32	14.4	E
Total	II		84.2	93.6	177.8	0.82	16.7	E

Arterial Level of Service: EB Paseo del Norte

Cross Street	Arterial Class	Flow Speed	Running Time	Signal Delay	Travel Time (s)	Dist (mi)	Arterial Speed	Arterial LOS
Universe	II	45	44.6	26.0	70.6	0.51	25.9	C
Loop Rd W	II	45	29.0	46.0	75.0	0.29	14.0	E
Unser Blvd	II	45	27.8	65.2	93.0	0.28	10.9	F
Loop Rd E	II	45	24.4	10.3	34.7	0.22	23.2	C
Transit Blvd	II	45	28.3	3.0	31.3	0.29	32.9	B
Kimmick Rd	II	45	33.0	19.5	52.5	0.34	23.5	C
	II	45	51.7	1.4	53.1	0.65	43.8	A
Total	II		238.8	171.4	410.2	2.58	22.6	C

Arterial Level of Service: WB Paseo del Norte

Cross Street	Arterial Class	Flow Speed	Running Time	Signal Delay	Travel Time (s)	Dist (mi)	Arterial Speed	Arterial LOS
	II	45	11.0	2.9	13.9	0.10	26.2	C
Kimmick Rd	II	45	51.7	28.1	79.8	0.65	29.2	B
Transit Blvd	II	45	33.0	15.9	48.9	0.34	25.3	C
Loop Rd East	II	45	28.3	26.0	54.3	0.29	18.9	D
Unser Blvd	II	45	24.4	135.8	160.2	0.22	5.0	F
Loop Rd W	II	45	27.8	5.7	33.5	0.28	30.1	B
Universe	II	45	29.0	13.6	42.6	0.29	24.7	C
Total	II		205.2	228.0	433.2	2.17	18.1	D

Arterial Level of Service: NB Unser Blvd

Cross Street	Arterial Class	Flow Speed	Running Time	Signal Delay	Travel Time (s)	Dist (mi)	Arterial Speed	Arterial LOS
Rose Parks	II	45	3.8	24.9	28.7	0.03	4.4	F
Loop Rd S	II	45	44.6	28.6	73.2	0.51	24.9	C
Paseo del Norte	II	45	24.3	30.5	54.8	0.22	14.6	E
Loop Rd N	II	45	24.4	1.2	25.6	0.22	31.5	B
Transit Blvd	II	40	26.7	15.9	42.6	0.24	20.5	D
Total	II		123.8	101.1	224.9	1.23	19.7	D

Arterial Level of Service: SB Unser Blvd

Cross Street	Arterial Class	Flow Speed	Running Time	Signal Delay	Travel Time (s)	Dist (mi)	Arterial Speed	Arterial LOS
Transit Blvd	II	45	10.3	12.6	22.9	0.09	14.9	E
Loop Rd N	II	44	25.2	5.1	30.3	0.24	28.8	B
Paseo del Norte	II	45	24.4	39.6	64.0	0.22	12.6	F
Loop Rd S	II	45	24.3	39.8	64.1	0.22	12.5	F
Rose Parks	II	45	44.6	20.0	64.6	0.51	28.3	B
Total	II		128.8	117.1	245.9	1.29	18.9	D

Appendix D

Turning Movements (Scheme A)

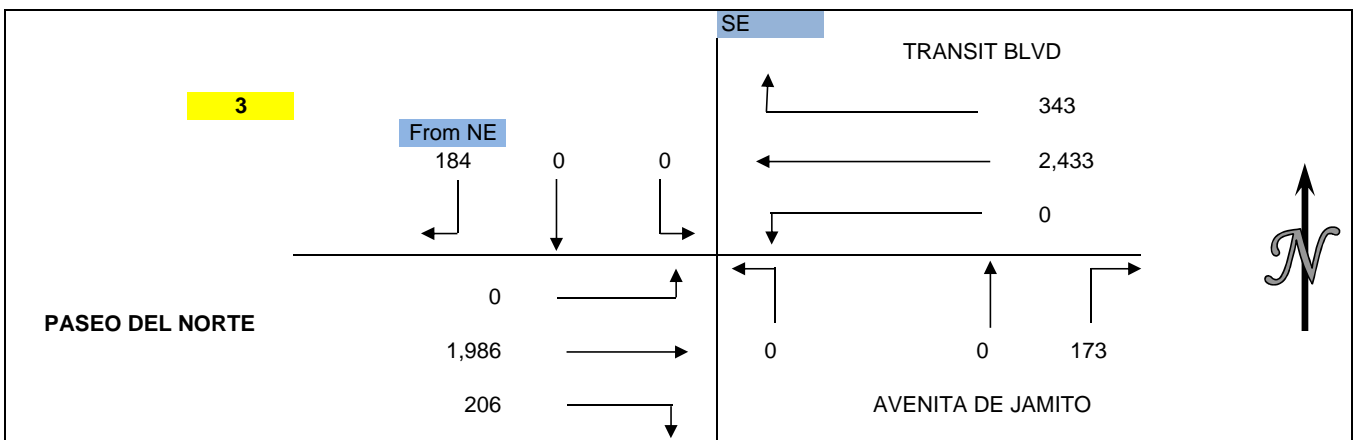
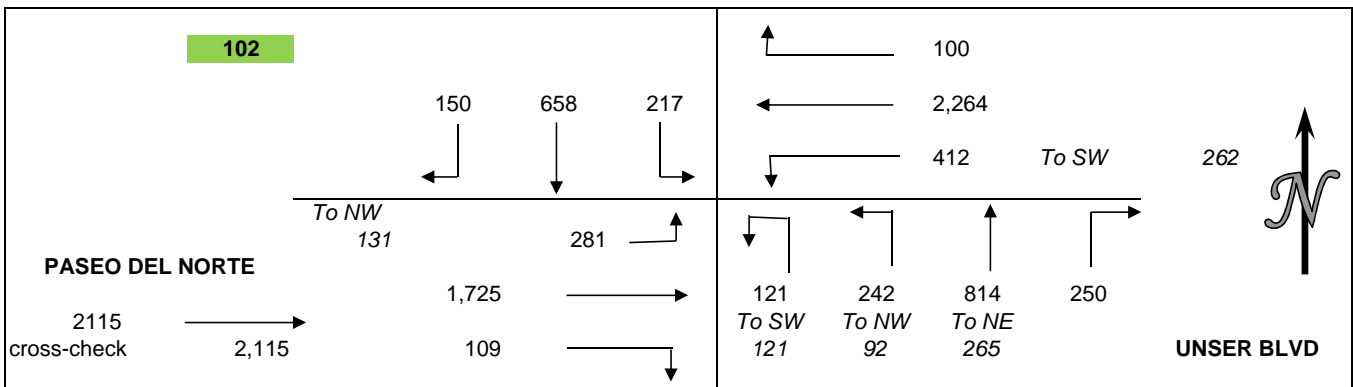
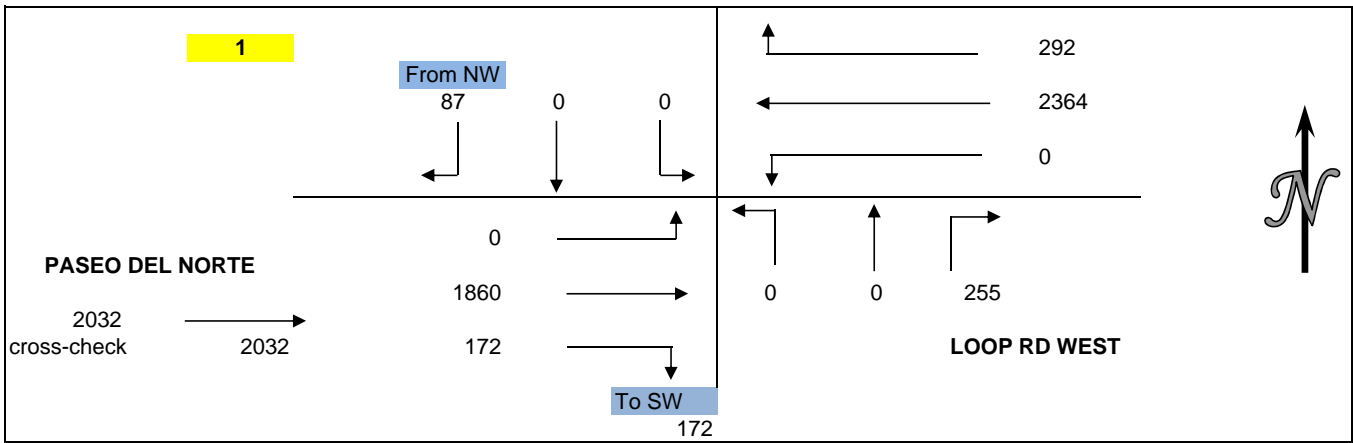
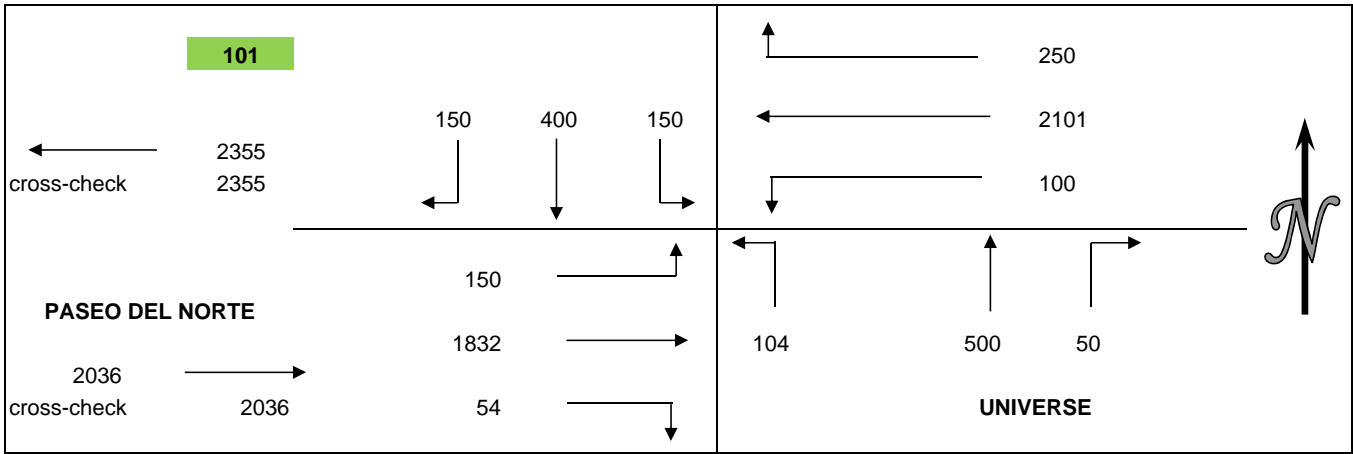

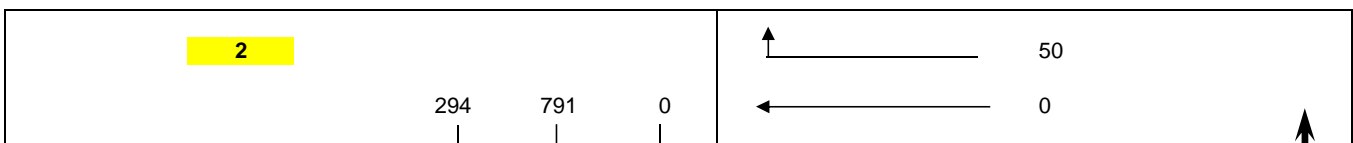
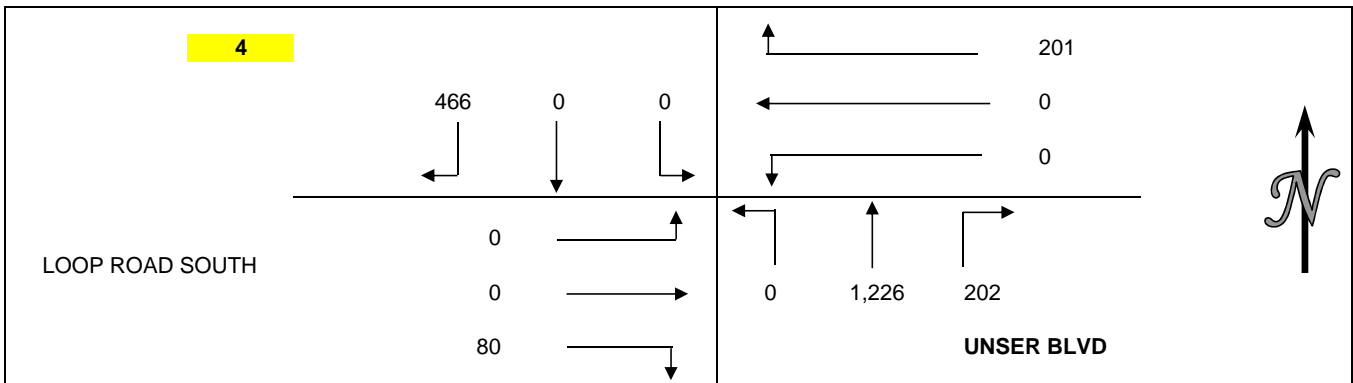
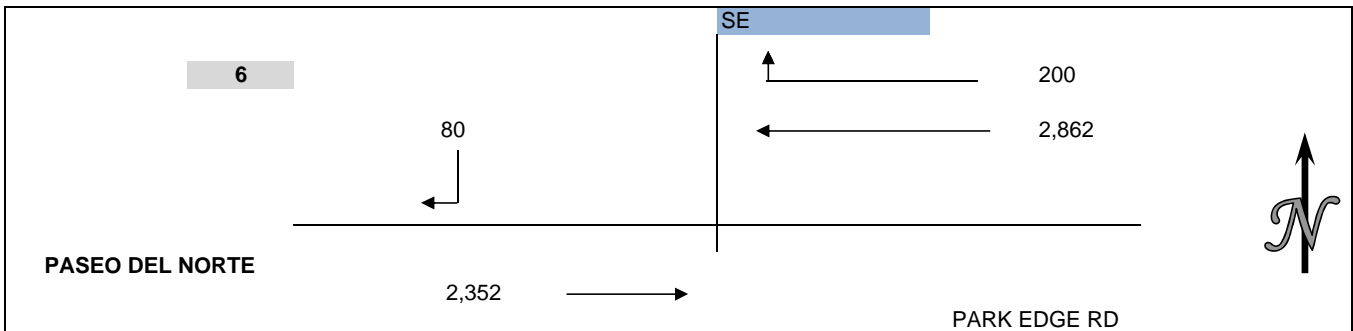
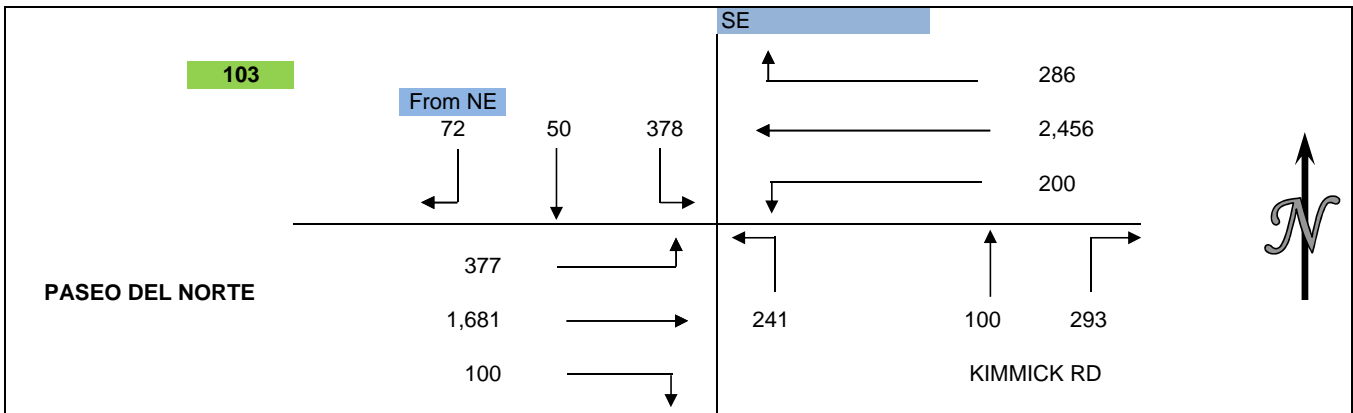
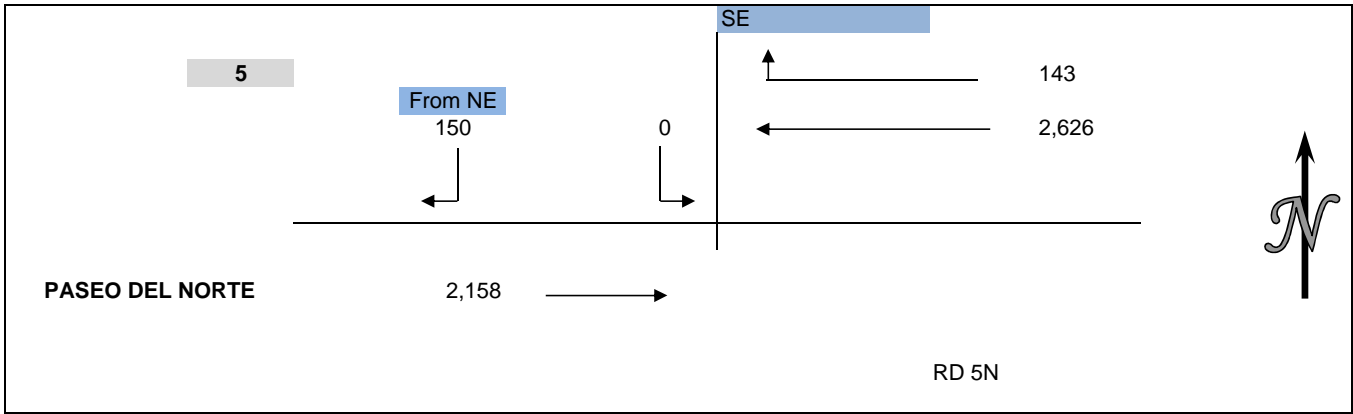

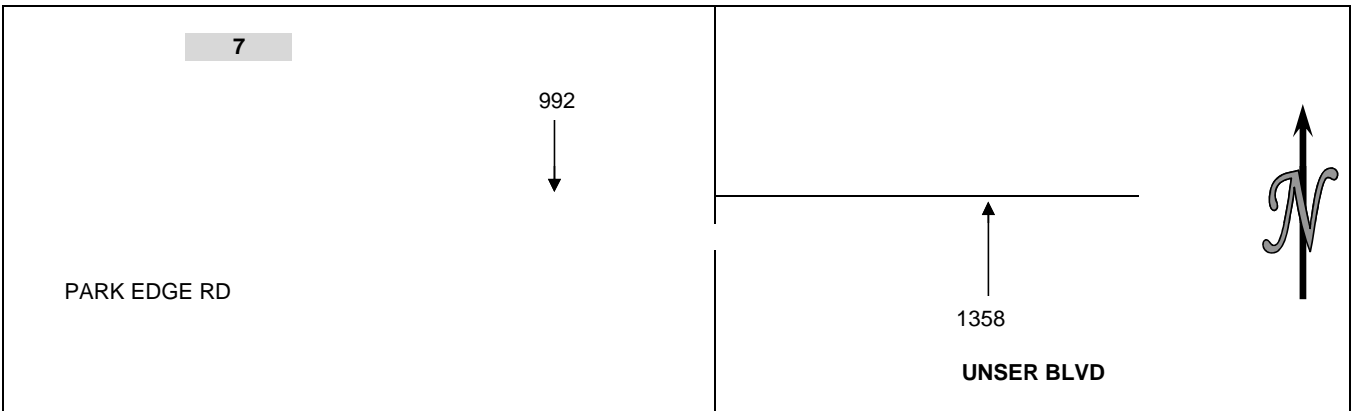
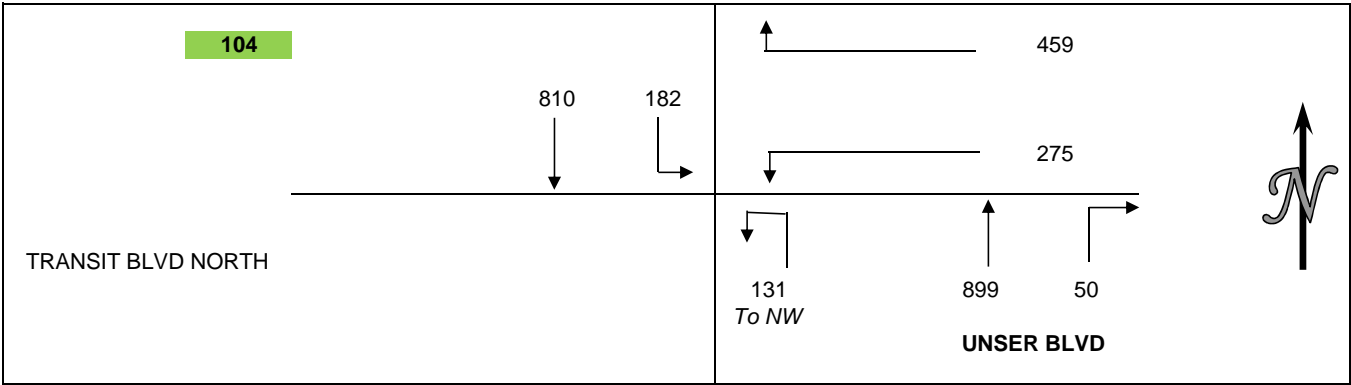
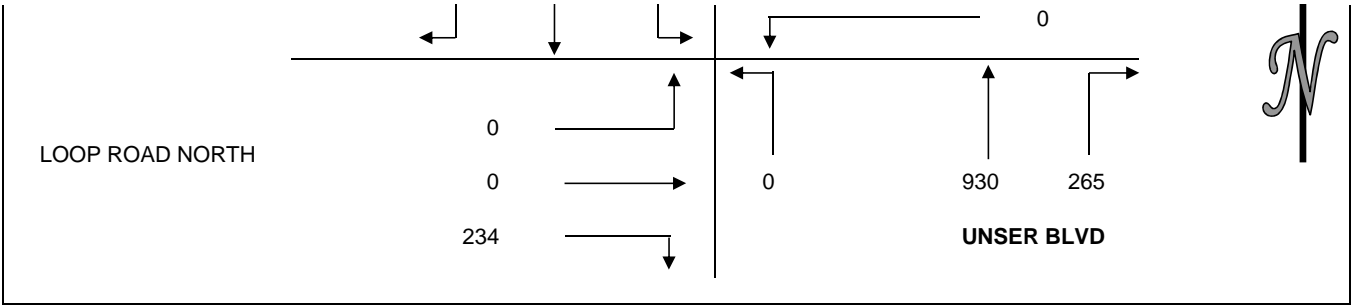

Time/Space Diagrams – Scheme B (1/2 mile spacing by Policy)

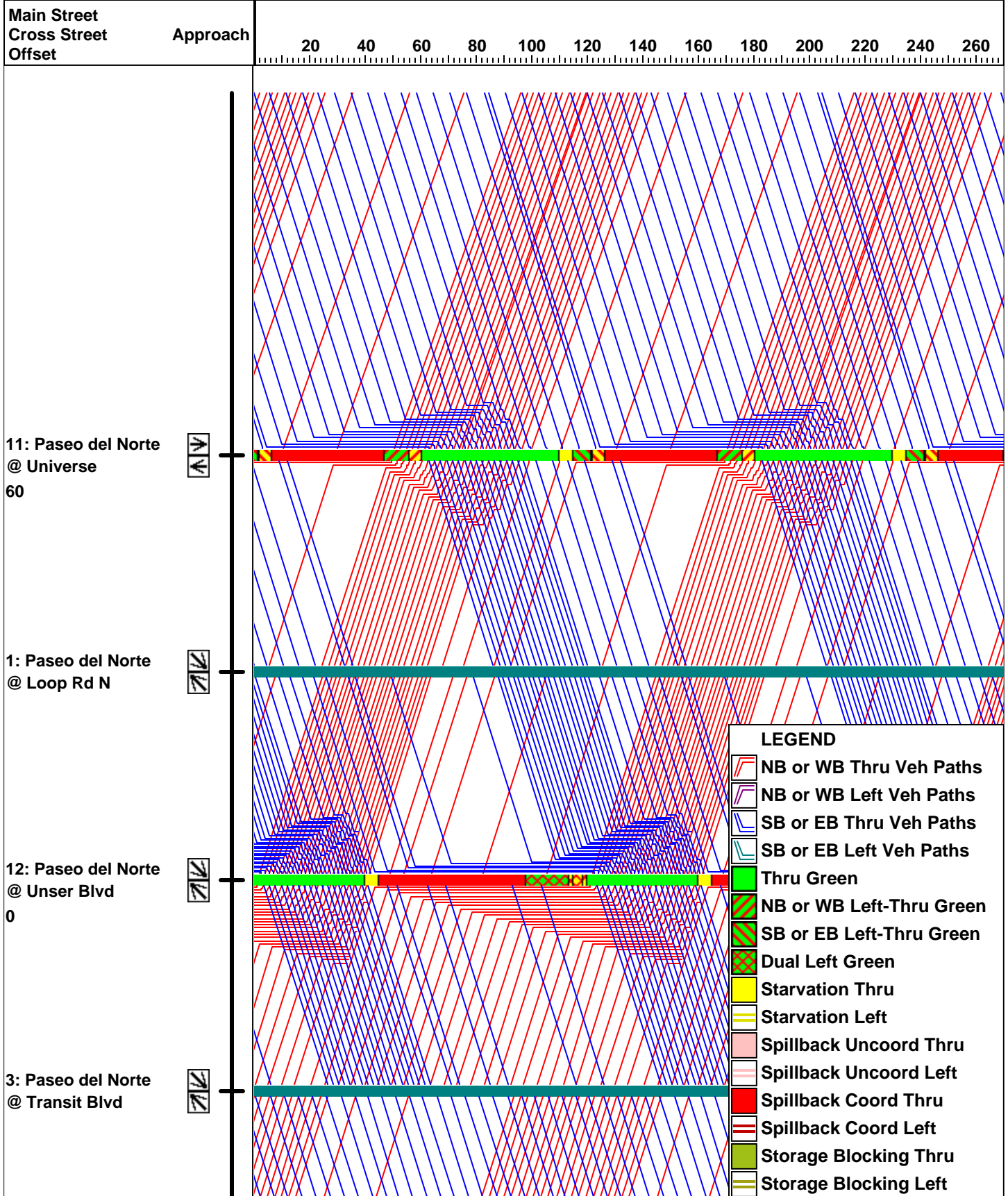

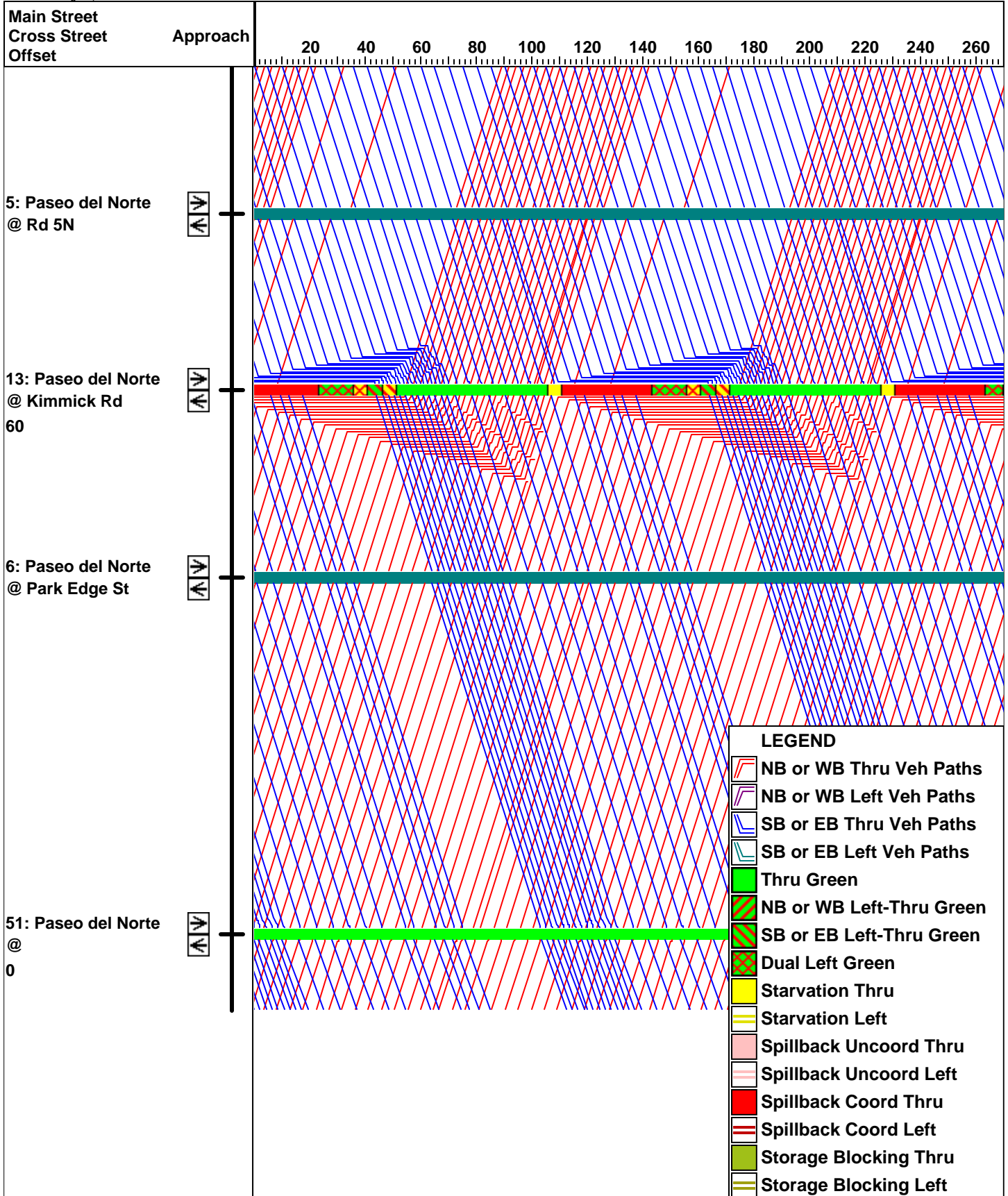

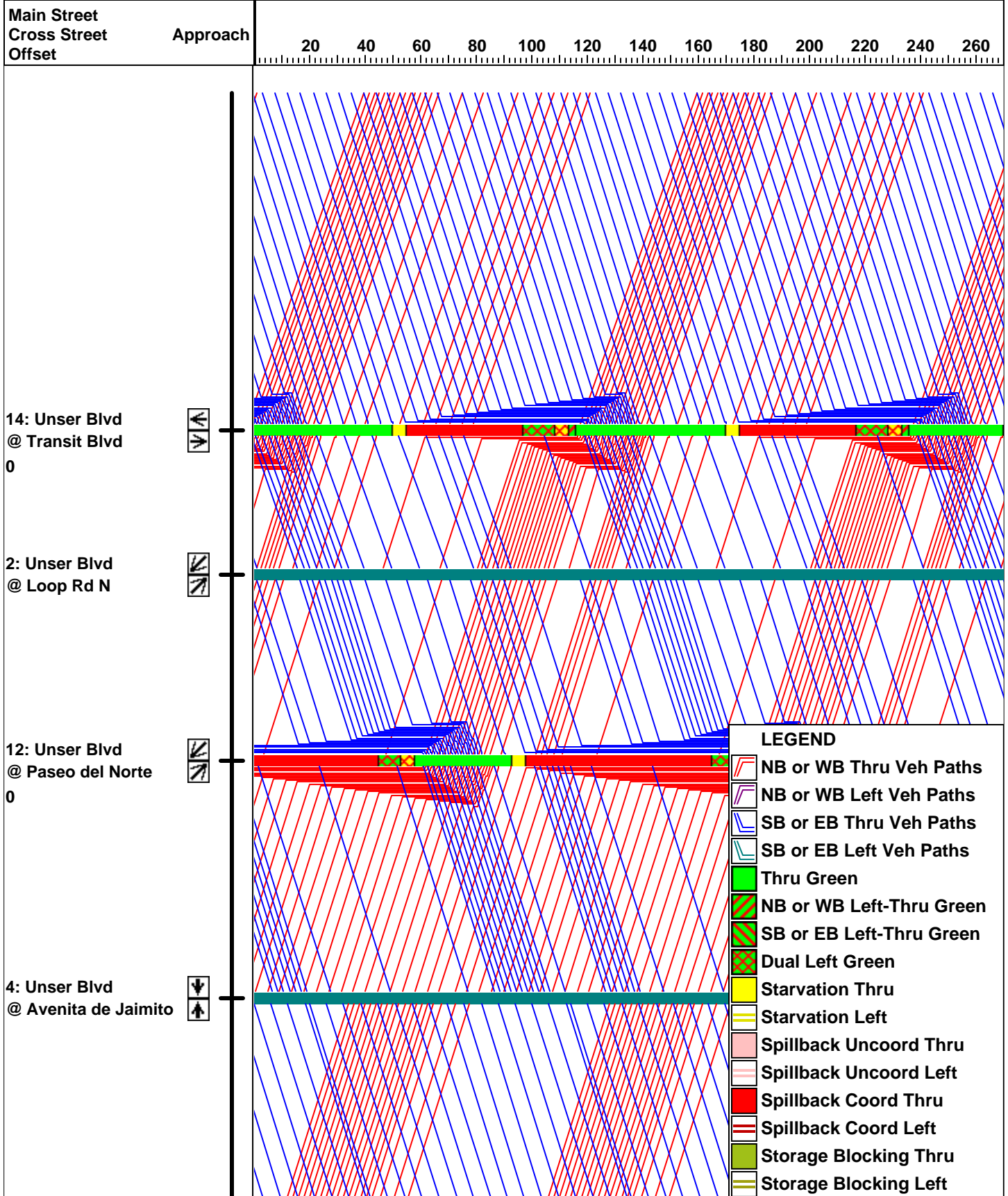

Time/Space Diagrams – Scheme D (City Spacing Request)

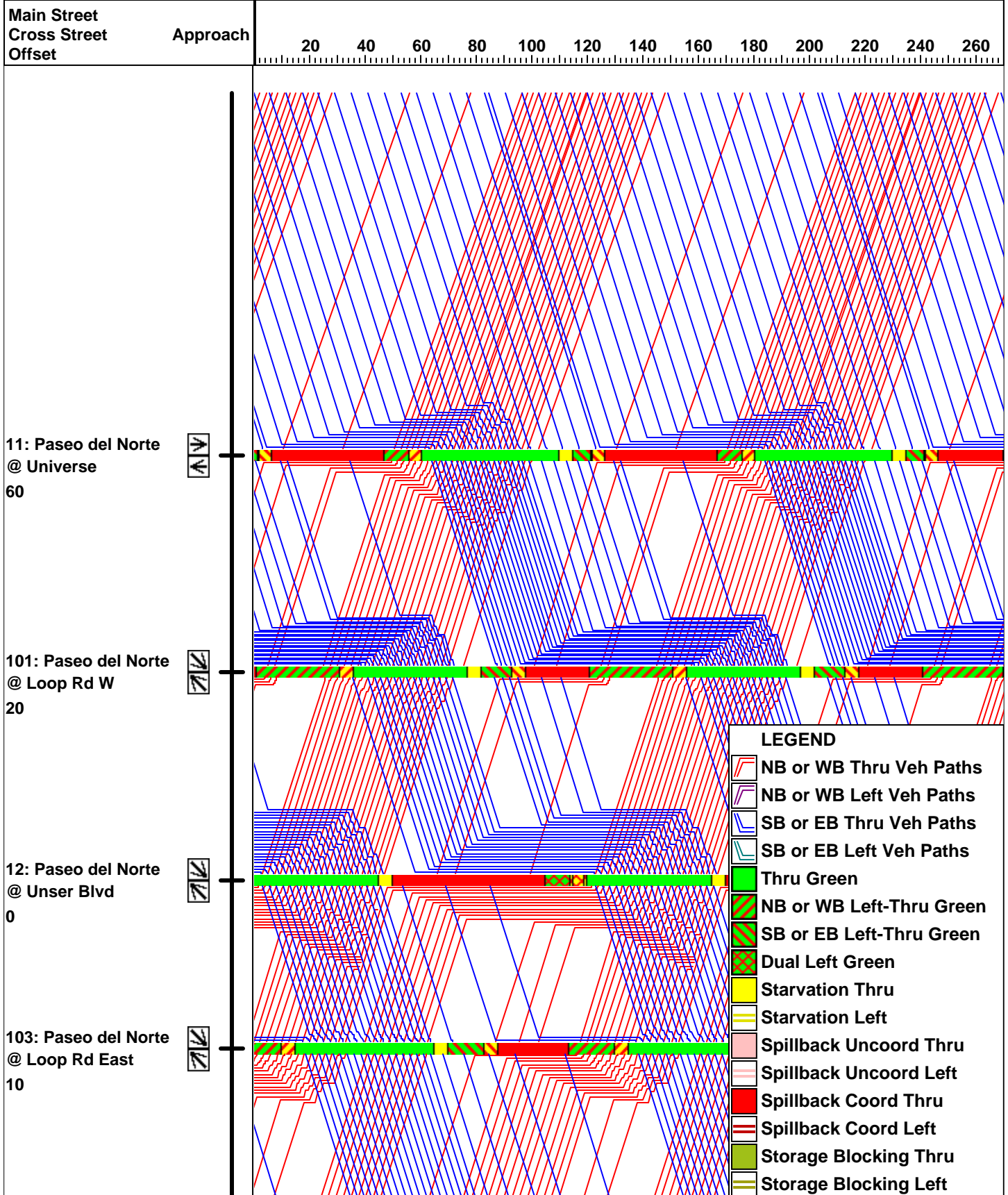

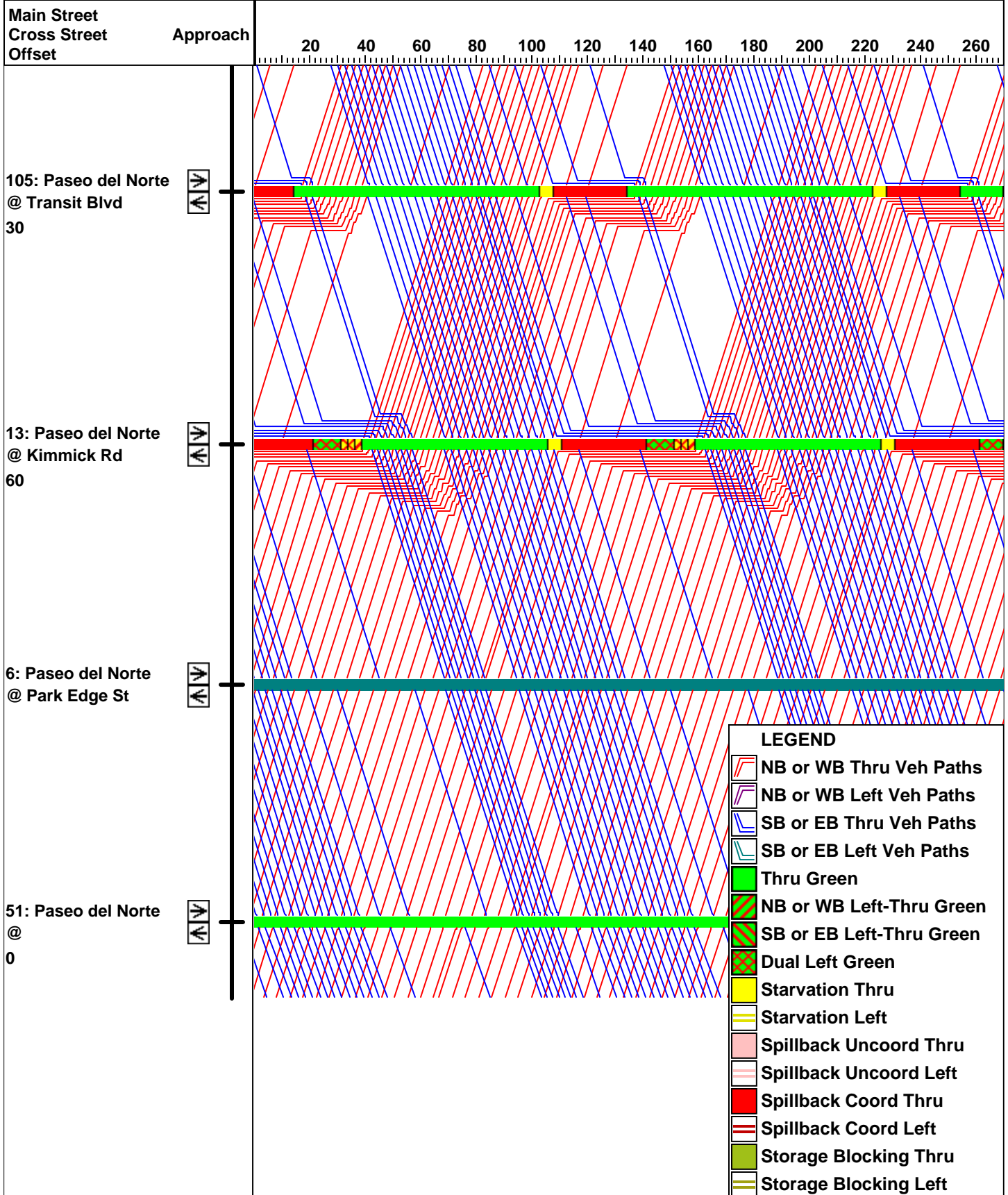

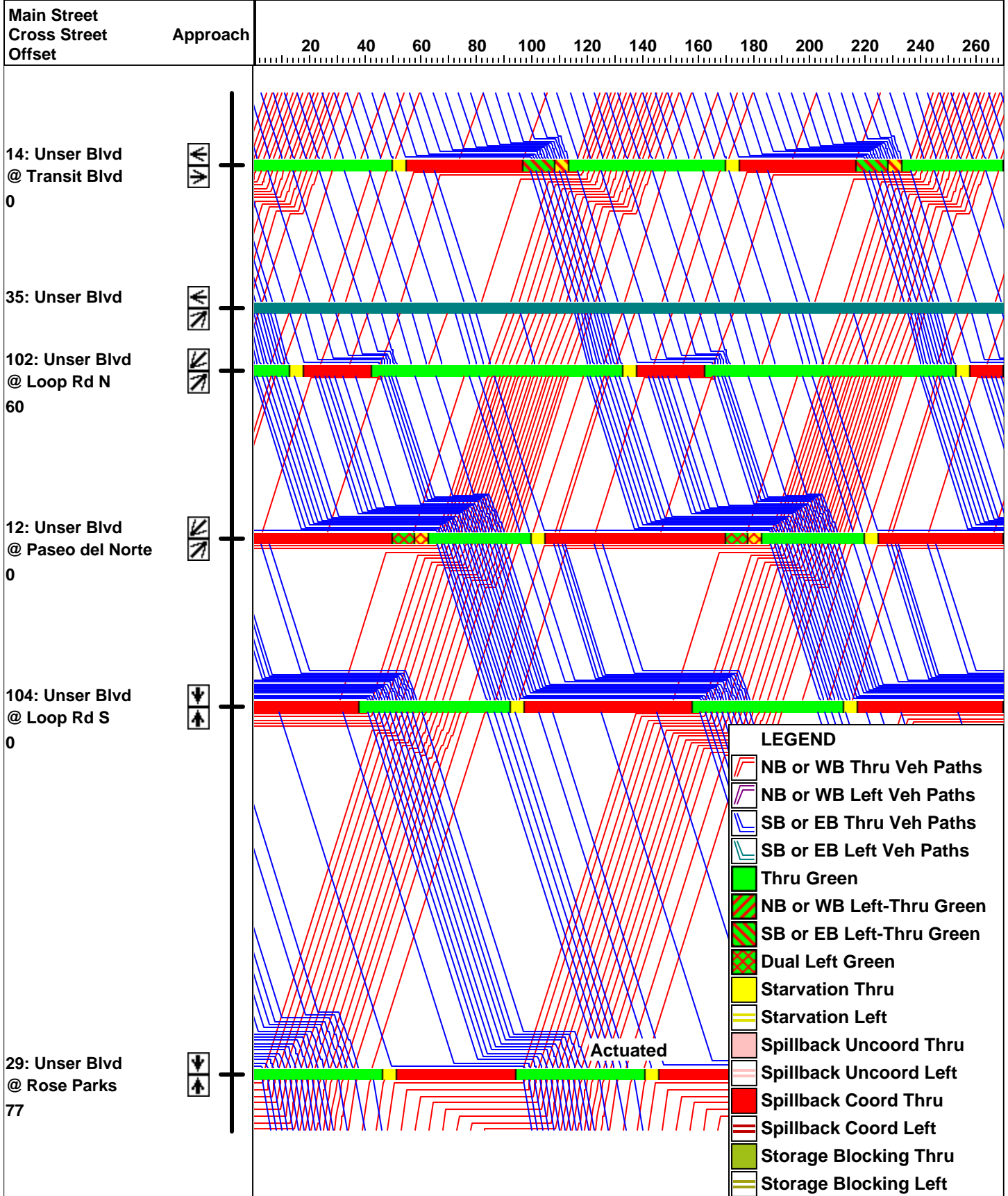

This Page Left Intentionally Blank

Appendix D

Private Preservation Options

APPENDIX

Appendix D. Private Preservation Options

ALTERNATIVE STRATEGIES FOR PRESERVING ROCK OUTCROPPINGS IN VOLCANO HILLS

Anita P. Miller
Assistant City Attorney

October 5, 2011

I. Transfer of Development Rights

A Transfer of Development Rights (“TDR”) strategy was considered in the 1990s in Albuquerque as a means of preserving significant natural and/or archaeological features on subdivided private land on the West Side of Albuquerque. One of the catalysts for the study was the petroglyphs which are located adjacent to already subdivided land. The Petroglyphs National Monument was becoming a reality, and the City did not want to see subdivision sprawl engulf private land near the Monument.

A Feasibility and Planning Analysis of TDRs in this context was prepared by Eric Damian Kelly, then a land use attorney and planner on contract with the City. At the time that the study was prepared, there was neither a state statute nor an Albuquerque ordinance governing TDRs. In 2003, NMSA 1978, §5-8-43 was adopted by the Legislature to provide guidance to counties and municipalities in regulating transfer of development rights.

- A. The purpose of this section is to
 - (1) clarify an application of existing authority;
 - (2) provide guidelines for counties and municipalities to regulate transfer of development rights consistent with comprehensive plans;
 - (3) encourage the conservation of ecological, agricultural and historical land; and
 - (4) require public notification of transfers of development rights.
- B. A municipality or county may, by ordinance, provide for voluntary transfer of all, or partial development rights from one parcel of land to another parcel of land.
- C. The ordinance shall identify on a zoning map areas from which development rights may be transferred and areas to which development rights may be transferred.
- D. The ordinance shall provide for:
 - (1) the voluntary transfer of a development right from one parcel of land to increase the intensity of development of another parcel of land;
 - (2) joint powers agreements, if applicable, for administration of transfers of development rights across jurisdictional boundaries;
 - (3) the method of transfer of development rights, including methods of determining the accounting for the rights transferred;

Appendix D. Private Preservation Options

- (4) the reasonable rules to effect and control transfers and ensure compliance with the provisions of the ordinance; and
 - (5) public notification to the areas to which development rights may be transferred.
- E. Transference of a development right shall be in writing and executed by the owner of the parcel from which the development right is being transferred and acknowledged by the transferor. A development right shall not be subject to condemnation.
- F. As used in the section, “development right” means the rights permitted on a lot, parcel or area of land under a zoning ordinance or local law respecting permissible use, area, density or height of improvements executed thereon, and development rights may be calculated and allocated in accordance with density or height limitations or any criteria that will effectively quantify a development right in a reasonable and uniform manner.
- G. Nothing in this section shall be construed to authorize a municipality or a county to impair existing property rights.

Neither Albuquerque nor Bernalillo County has adopted TDR ordinances. It should be noted that in the *Feasibility and Planning Analysis*, Eric Kelly determined that New Mexico municipalities and counties could adopt TDR programs without a statute or local ordinance, based on already adopted planning and zoning statutes and ordinances.

“Transferable development rights” are rights to develop property that are valued based on existing zoning, or based on market potential of the property as developed. The TDR process is usually used to preserve historic property, archaeological sites, and open space; to preserve agricultural land from development; or to create incentives for high-density development in another area of a municipality.

Kelly sees “cluster zoning” as a simple example of TDR. In cluster zoning, a landowner may develop a part of his property at a high density, leaving the rest of the property as undeveloped open space. Since only one property is involved, cluster zoning doesn’t usually create controversy, although neighboring property owners adjacent to a receiving area which will be more dense than their properties may object based on the impact that this development might have on their neighboring property values.

Likewise, when a TDR process is applied to an undeveloped property currently in agriculture, but there also is designated land elsewhere in the jurisdiction for dense development, the process succeeds. The agricultural land is retained, and the farmer reaps the economic benefit of higher valued developed property.

TDRs often become controversial when the existing zoning in a receiving area is changed to enable development rights to be transferred into it. Therefore, TDRs work best when both the sending area and receiving area haven’t been permanently zoned or are in a “holding area,” and are designated as part of a planning process. TDRs, then, might succeed in preserving rock outcroppings in Volcano Heights if an underdeveloped receiving area for development rights transferred in order to preserve the rocks is designated in the current planning process.

APPENDIX

Appendix D. Private Preservation Options

It should be noted that a variation of TDR, “Purchase of Development Rights” (“PDR”) has successfully been implemented in Massachusetts. The state purchased development rights from farmers on land which it wished to remain in agriculture. A variation of PDR can be found in Chicago, where development rights in the Hyde Park area were purchased by the City, and placed in a “bank”. Developers could then purchase them from the “bank”, and utilize them to create more dense development in a new area which the City wanted to see densely developed.

In the context of Albuquerque, owners of land containing rock outcroppings that are designated for preservation might also transfer their development rights to redevelopment areas elsewhere in the City. Redevelopment areas recently have been rezoned for higher density mixed uses, which might make them appropriate as “receiving areas.”

Kelly mentions that a TDR program can be defeated by popular opposition when an existing zoning designation is changed to accommodate receipt of development rights. It is assumed that the original zoning served the health, safety and general welfare of the area. When the area receives development rights and thus higher densities, the justification for the lower densities of adjacent properties no longer exists, and property owners in adjacent neighborhoods believe that their property values will plummet.

When Eric Kelly prepared his study in the 1990s, his conclusion was that they wouldn’t work in Albuquerque, except when a property owner had sufficient land to “receive” higher density. In those days, even cluster development in the developed areas of the City was met with harsh opposition from adjacent and nearby neighborhood associations. Whether a TDR program, with receiving areas designated elsewhere in the City, would succeed today, given today’s growing preference for higher density development,

is open to question. Kelly suggested that conservation easements might provide a better strategy for preserving land without the City actually owning it.

II. Conservation Easements

In New Mexico, “conservation easements” are defined as “Land Use Easements,” as follows:

NMSA 1978, §47-12-1 (1991)

- H. “land use easement” means a holder’s nonpossessory interest in real property imposing any limitation or affirmative obligation the purpose of which includes retaining or protecting natural or open space values of real property, assuring the availability of real property for agricultural, forest, recreational or open space use or protecting natural resources;

At A. of the statute,

“holder” means any non-profit corporation, nonprofit association or nonprofit trust, the purposes or powers of which include retaining or protecting the natural or open space values of real property, assuring the availability of real property for agricultural, forest, recreational or open space use, protecting natural resources or maintaining production uses of real property.

Local governments qualify as “holders.” Thus the City could protect the rock outcroppings in Volcano Heights by obtaining conservation easements on areas of land containing those

Appendix D. Private Preservation Options

rock outcroppings identified as desirable to preserve. The easements are recorded, and are governed by their specific terms. Their terms could include conditions for termination, as well as other limitations if so desired. The owner of the property would continue to own the land burdened by the easement, and would be responsible for its care and maintenance, but would not be able to develop it. The New Mexico Tax Code gives tax benefits to the landowner whose property is burdened by the easement, as does the Internal Revenue Code.

The property owner could fence in the property burdened by the easement and exclude the public; it's still his private property. If a property owner is going to develop the property as a shopping center or office park, inviting the public in, he could also invite citizens to the area protected by the easement. Terminology in the drafted easement could reflect the property owner's particular responsibilities as negotiated.

Although the Open Space Division would like to see the rock outcroppings purchased outright by the City, given budgetary limitations, obtaining a conservation easement would preserve them from development, pending availability of funds for their purchase. If such funds never were available, at the very least they'd be preserved.

It should be noted that Santa Fe County, as a result of two successful bond issues, was able to purchase land in the Galisteo Basin which contained archaeological sites. When it realized that there was additional land which also had archaeological value, and didn't have funding to purchase it as well, it utilized a conservation easement to protect it from development. A third bond issue provided sufficient funds for purchase of the land, and the easement was terminated. Thus Albuquerque could "tie up" the rock outcroppings pending obtaining funding for purchase of the sites. If preservation is the ultimate goal, lack of public access is a small price to pay.

Conclusion

If there are areas in Volcano Heights where TDRs would "work," either on the property where rocks are to be preserved or another property within the Plan area or in a specific zone where mixed use zoning and density are encouraged, existing incentives, such as increased density on the receiving site might be utilized to "reward" a property owner for transferring development rights. Certainly neighborhood associations would oppose the creation of receiving areas on Albuquerque's east side, although they might be acceptable on large redevelopment sites that might encourage high density development.

Conservation easements are easier to administer and create than TDRs. Considering that the Open Space Division prefers acquisition of property which it has designated as open space, but cannot now afford to purchase, conservation easements could preserve the designated property until funding is available to purchase it. On October 4th Albuquerque citizens voted down one of the Mayor's proposals for bond issues, reflecting public opposition to two public projects. In the current economic climate, it's likely that bond issues for purchase of open space might also be voted down. Conservation easements at least provide a method for preserving designated open space when funding isn't available to purchase it.

APPENDIX

Appendix D. Private Preservation Options

Conservation Easement for Rock Outcropping (Sample)

This Deed of Conservation Easement is granted on the day of ____ by ____ concerning the address of ____ to the City of Albuquerque for the purpose of forever conserving the cultural values of said property.

Recitals:

Significance:

The property contains special cultural significance to Pueblo people, including several nearby tribal nations. This land consists of open space containing various rock outcroppings scattered throughout. The preservation of these outcroppings shall be preserved pursuant to the NM Cultural Properties Preservation Easement Act, NMSA 1978, Sections 47-12A-1 through 47-12A-6. This act aids the landowner who wishes to voluntarily donate a conservation easement intended to restrict the use of this specified parcel so as to maintain in perpetuity the significant cultural and/or geological aspects of this land. Conserving the property is consistent with and important to the environment, culture, and economy of the surrounding area because the development of the property would jeopardize the cultural significance of the area to native people. These sites provide Pueblo people with spiritual areas to hold sacred rituals and ceremonies that have held great cultural significance for countless generations. It is important to hold these areas open to future generations of interested parties to keep the spiritual significance of the area alive.

Qualifications:

The City of Albuquerque is a qualified “holder” as described by NMSA 1978, Section 47-12A-2 and an eligible holder pursuant to the Land Conservation Incentives Act NMSA 1978, Sections 75-9-1 to 75-9-6 (2003).

Intent of Conveyance:

The land owner intends to make a charitable gift of the development interest conveyed by this deed for the purpose of assuring that under the holder’s perpetual oversight, the conservation values will be maintained forever and that any misuse of the property inconsistent with the conservation values will be corrected or prevented. The intent of this conveyance is to permit all other uses of the land not inconsistent with the conservation values as determined by the City of Albuquerque in its sole discretion that are not expressly prohibited in this deed. Nothing in this deed is intended to compel the property holder to use the property in any way other than maintaining protection and conservation values. Conveyance of this deed will not adversely affect the property owner’s property rights to develop the remainder of the property not covered by the conservation easement.

Appendix D. Private Preservation Options

Agreement:

Now therefore, in consideration of the mutual promises and covenants contained herein, the landowner voluntarily grants and conveys the land in trust to the City of Albuquerque, and the City of Albuquerque voluntarily accepts a perpetual “land use easement” over the property herein described as subject to the easement as defined by NMSA 1978, Section 47-12A-2B of the Cultural Properties Preservation Easement Act, which is also a “qualified real property interest” as defined by the C.F.R. 170(h)(2)(c), the conveyance of which is a “charitable contribution” as defined by C.F.R. 170(h).

Property Rights Retained by Owner:

Landowner reserves to himself/herself, and to his/her personal representatives, heirs successors, and assigns, all rights not expressly prohibited or limited by this easement, including all ownership rights of the Property, the right to include or exclude others, the right to sell or otherwise transfer ownership, and the right to mortgage the Property so long as the Mortgage is subordinated to this Deed.

General Uses of the Property: The landowner shall not perform nor knowingly allow others to perform acts that are inconsistent with the conservation or preservation purposes enumerated by this deed. The City of Albuquerque and the landowner acknowledge that any uses of the property or improvements of the property enumerated in this deed are consistent with the Conservation purposes. The landowner agrees that any other use of the land that is inconsistent with the law imposed on the Property is not protected by this deed.

Various Specific Uses:

- A. Subdivisions: The landowner and the City of Albuquerque agree that the property must be sold or transferred as a single unit and that any further subdivision of the Property is prohibited, unless approved by the City of Albuquerque, in its sole discretion. Any adjustments to the lot lines must be approved by the City of Albuquerque. If the property is transferred or sold, the landowner must provide to the City the address and name of the grantee.
- B. Construction: Any existing structure on the Property can be repaired, maintained, or replaced in its current location, but construction of new structures on the Property is prohibited unless at least 30 days prior to undertaking any construction, and prior to applying for a building permit for such construction, the landowner shall notify the City of Albuquerque in writing and provide the City of Albuquerque with the opportunity to review the plans for such construction for compliance with the terms of this deed. The City has the power to deny any such development that does not meet the terms of this deed.
- C. Water Rights: The voluntary separation of water rights from the Property is hereby prohibited, except as provided herein. The landowner shall take all prudent measures to ensure that forfeiture or abandonment do not occur for the Property, including maintaining timely payments, beneficial use and participation in conservation programs. If for any reason the landowner cannot beneficially use the water rights on the Property, the rights can be transferred to the City of Albuquerque for purposes of conservation or elsewhere as long as it is consistent with the conservation purposes of this easement. If transferred elsewhere, the landowner must receive written consent by the City of Albuquerque to lease or transfer the rights.

APPENDIX

Appendix D. Private Preservation Options

- D. Agriculture: All agricultural practices should be conducted in a sustainable manner. This includes ranching, farming and other agricultural practices. Agricultural practices shall use stewardship and management practices generally consistent with the standards of the U.S. Natural Resources Conservation Service or other commonly accepted sound management practices approved by the City to meet the conservation purpose of this deed.
- E. Timber: The cutting of any timber from on the Property is strictly prohibited except for fire management, to control insects or disease, to prevent personal injury and property damage, to maintain the character and nature of the existing natural habitat, and/or to prevent encroachment into agricultural fields and pastures.
- F. Utilities: The construction of new utilities on the property is prohibited without the prior written approval of the City of Albuquerque. This includes underground utilities.
- G. Roads: The construction of new roads shall be prohibited from the Property. If for some reason there is a specific need for a road, the landowner may present the City of Albuquerque with plans at least 30 days prior to receiving any permits or beginning any actual construction and must receive written consent from the City of Albuquerque to proceed.
- H. Off-road Vehicle Use: The use of any motorized vehicle is prohibited on the property except for the purposes of maintenance, conservation, agriculture, or emergency access.
- I. Impervious Surfaces: The construction of any permanent, impervious surface such as pavement or asphalt is prohibited except for those approved pursuant to paragraph G of this deed.
- J. Mining: The mining of gravel, rock, sand soil and other minerals is prohibited as consistent with the conservation values proposed in this deed.
- K. Refuse: The dumping, storing, or accumulation of any form of refuse is strictly prohibited from the property. Should any refuse be found on the property it is the landowner's duty to remove it. This prohibition does not apply to any form of composting as long as it is done in a manner consistent with the Conservation values expressed in this deed.
- L. Hazardous Materials: The storage, release, or treatment of hazardous chemicals on, from, or under the property is prohibited. For the purposes of this deed, any "Hazardous material" shall be any hazardous or toxic, material or waste considered hazardous according to any state, federal, or local laws.
- M. Commercial Activity:
 - a. Generally: Any commercial activity including producing, buying, selling or trading of goods or services shall be prohibited with the exceptions of recreational or home activities described below.
 - b. Commercial Recreational Activities: Use of the property other than "de minimis" uses as described in the Code of Federal Regulations (C.F.R.) 2031(c)(8)(B) are prohibited.
 - c. Commercial Home Activities: This deed does not prohibit home commercial activities legally permitted within the home by local zoning laws, as long as they are consistent with the conservation values in this deed.

Appendix D. Private Preservation Options

- N. Recreation: Only low-impact recreational activities are permitted, such as rock study, wildlife viewing, hiking, biking, horse-back riding, snowshoeing, or cross country skiing not inconsistent with the conservation values of this deed. Recreational facilities may only be constructed in accordance with the restrictions pursuant to section B of this Deed. The use of motorized vehicles for recreational purposes is prohibited pursuant to section H of this deed.
- O. Public Access: This deed is not intended to allow public access to the property, and the landowner maintains his/her property right to exclude any trespassers, as well as his/her right to include any public access he/she sees fit in accordance with the conservation values expressed in this deed. The City of Albuquerque maintains no obligation to take any actions to prevent trespassers on the property.
- P. Signs: The use of signs shall be prohibited other than those warning trespassers of private land, signs that explain it is in the care of the City of Albuquerque, for sale signs, or any notice or postings required by law. The signs shall not exceed two by two feet, be made of reflective material, or be artificially illuminated.

Duration of the Deed: This deed shall last with the title of the land in perpetuity, and every provision of the deed shall likewise apply to any heirs, assigns, successors, executors, administrators, and all other successors. The transfer of title shall excuse the grantor of the obligations of the provisions of this deed except those for which he/she is liable before the transfer of title. The City of Albuquerque maintains the right to review the provisions of the deed and shall do so every five years and shall be at liberty to cancel or transfer their position as a holder for this easement.

Responsibilities of Landowner: Other than as specified herein, this deed is not intended to impose any legal or other responsibility on the City of Albuquerque, or in any way to affect any obligation of the landowner as owner of the property. Unless otherwise specified below, nothing in this Deed shall require the landowner to take any action to restore the condition of the property after any Act of God or other event over which landowner had no control. The landowner shall continue to be solely responsible, and the City of Albuquerque shall have no obligation for the upkeep and maintenance of the property. The landowner acknowledges that nothing in this Deed relieves the landowner of any obligation or restriction on the use of the Property imposed by law. Among other things, this shall apply to:

- a. Taxes: The landowner is solely responsible for the payment of all taxes and assessments levied against the property. If for any reason the City of Albuquerque is forced to pay any taxes or assessments on its interest in the Property, the landowner shall reimburse the City of Albuquerque for the full amount, and such payment shall constitute a lien on the property.
- b. Upkeep and Maintenance: The landowner shall be solely responsible for the upkeep and maintenance of the property.
- c. Liability and Indemnification: The landowner shall be solely responsible for any liability arising from or related to the property, including injury or damage to any person or organization related directly or indirectly to the action or omission by the landowner. If for any reason the City of Albuquerque has to pay for any damages, the landowner shall indemnify and reimburse the City for the amount as well as any attorney fees resulting from the costs of defending itself. The landowner shall not have to reimburse the City of Albuquerque if the City is to be the proximate cause of the injury.

APPENDIX

Appendix D. Private Preservation Options

- d. Insurance: The landowner warrants that the City of Albuquerque is and will continue to be an additional insured on the landowner's liability insurance policy covering the property. The landowner shall provide certificates of such insurance to the City of Albuquerque within thirty days after the date of recordation of this deed and subsequently, upon the City of Albuquerque's written request. Landowner shall advise the City of Albuquerque at least thirty days in advance of cancellation of any insurance policy.

Landowner Warranties:

- a. Title warranty: The landowner warrants that he/she has good and sufficient title to the property, and that there are no liens on, leases to, pending or threatened litigation relating to the Property, or other interests in the property, including verbal agreements, that have not been disclosed to the City of Albuquerque in writing. The landowner hereby promises to defend the property and the easement against all claims from persons claiming by, through, or under the landowner. In the event any cloud of title exists, the landowner shall be responsible for procuring a release of claim signed by the relevant parties.

- a. *If the landowner has a mortgage on property:* The landowner warrants that he/she has good and sufficient title to the property, that the lien on the property held by _____ dated _____, has been subordinated to this deed, and that there are no other liens on, leases to, or other interests in the property that have not been disclosed to the City of Albuquerque in writing. The landowner hereby promises to defend the property and the easement against all claims from persons claiming by, through, or under the landowner.

- b. Environmental Warranty: The landowner warrants that he/she has no knowledge of a release or threatened release of hazardous material on the property. The landowner will indemnify, defend, and hold harmless the City of Albuquerque against any litigation, claims, costs, damages, losses, or any other expenses of any kind arising from the release of hazardous material on the property. Nothing in this deed is intended to convey any sort of day-to-day managerial right to the City of Albuquerque from the landowner. The owner of the property retains the right to manage the property, subject to restrictions in this easement and any federal, state, or local laws, regulations or ordinances governing environmental conditions on the property.

Inspection: The City of Albuquerque maintains the right to inspect the property as long as the City gives the landowner reasonable, advance notice. The City of Albuquerque will typically inspect the property annually but reserves the right to inspect it any time as long as the City gives the owner proper notice. If the City of Albuquerque has reason to believe that there is an ongoing, imminent, or threatened violation of the provisions of this deed, the City of Albuquerque will make good faith efforts to contact the landowner but may enter the Property in an effort to avert this emergency without needing to give prior notice to the landowner.

Enforcement: The City of Albuquerque has all the rights, remedies, and power to enforce the terms of this deed against the landowner that are provided by law or in equity including actions prior to court action such as mediation or arbitration. Except when an ongoing or imminent violation could irreversibly diminish or impair the conservation values described in this easement, the City of Albuquerque will give written notice of the violation to the landowner and he/she will have thirty days before the City of Albuquerque will take

Appendix D. Private Preservation Options

legal action. If a court with jurisdiction determines that a violation may exist or has occurred, the City of Albuquerque may obtain an injunction to stop the violation, temporarily or permanently, and to restore the Property to its condition prior to the violation. In any case where a court finds that a violation has occurred, the landowner shall reimburse the City of Albuquerque for all its expenses incurred in stopping and correcting the violation, including reasonable attorneys' fees and court costs. If the court finds no violation, the landowner and the City of Albuquerque shall each bear individual expenses and attorneys' fees. The landowner and the City of Albuquerque agree that this allocation of expenses is appropriate.

Transfer of Easement: The City of Albuquerque maintains the right to transfer this easement to another qualified holder according to the subsections below:

- a. Voluntary: if the City of Albuquerque ever wants to voluntarily transfer the easement, the City will give notice sixty days before the transfer takes place in order to allow the landowner to voice any preferences as to who the new holder shall be. The City of Albuquerque shall take due consideration of this suggestions and shall choose accordingly. This easement can only be transferred to an organization that is qualified as a holder under NMSA 1978, Section 47-12A-2B and that agrees to uphold the terms of this Deed.
- b. Involuntary: If the City of Albuquerque ceases to qualify under C.F.R. 170(h)(3), or NMSA 1978, Section 47-12A-1 through 47-12A-6, a court with proper jurisdiction shall dictate the transfer or this deed to another qualified organization that agrees to uphold the terms of this Deed.

Amendment of Easement: The City of Albuquerque and the landowner agree that there may be situations in which the need to amend various provisions of the deed may arise and agree that in order to amend any provisions, both the City of Albuquerque and the landowner must agree in writing to any such changes. Any written agreement, executed by both the City of Albuquerque and the landowner, to amend this deed must be filed with the County Clerk's office in which this deed is filed.

Termination of the Easement:

- a. Condemnation: The City of Albuquerque shall be informed by the property owner of any condemnation action undertaken by the federal or state government within 10 days of initiation of that action. If all or a part of the property is taken for public use (or sold to a public authority under threat of condemnation), and the easement is terminated in whole or in part, then the City of Albuquerque shall be entitled to a percentage of the condemnation award or sale proceeds (including any increase in value caused by improvements made after the date of this Deed) equal to the ratio, as of the date of this Deed, of the appraised value of the Easement to the unrestricted fair market value of the property.
- b. Changed Conditions: The landowner and the City of Albuquerque recognize that in some cases all conservation value of the property may be irreversibly lost due to changes not caused by any particular party. The City of Albuquerque and the landowner retain the right to jointly request a court with jurisdiction to terminate all or a portion of this deed and order the sale of the property. The irreversible loss of all conservation value is the only grounds upon which to terminate this deed. Upon the sale of the land, the City of Albuquerque shall be entitled to a percentage of the sale proceeds (including any increase in value caused by improvements made after the date of this

APPENDIX

Appendix D. Private Preservation Options

deed) equal to the ratio, as of the date of this Deed, of the appraised value of the Easement to the unrestricted fair market value of the property.

- c. **Other Termination Conditions:** This Deed constitutes a property right conveyed to the City of Albuquerque that shall immediately vest once this deed has been signed by the County Clerk and filed in the official records of Bernalillo County and shall give the City of Albuquerque the rights to the fair market value of the apportioned land, which will be stipulated to be between the landowner and the City of Albuquerque. Any funds the City of Albuquerque receives from the termination of this easement shall be used in a way consistent with the conservation values expressed in this agreement.
- d. **Economic Termination Conditions:** In no circumstances will the economic devaluation of the property or economic infeasibility of this easement be seen as grounds appropriate to terminate this easement.

Approvals: Before doing anything that requires the approval of the City of Albuquerque, the landowner agrees to request the approval from the City of Albuquerque in writing. The City of Albuquerque shall be given forty-five days from the day of receipt to respond in writing to the written request of the landowner.

Notices: Any written notices required by this deed shall be hand delivered or sent through the US mail services. The current addresses as of the date of creating this deed for the landowner and the City of Albuquerque are as follows:

To the Landowner:

To the City of Albuquerque:

All parties must be notified of any changes of addresses. Also the address of the Property shall be a suitable address for the City of Albuquerque to address any notices they are required to send to the landowner.

Transfer of the Property: The landowner retains the right to transfer or sell his property rights at any time as long as this deed remains attached to the property rights in the conveyance and that he/she gives the City of Albuquerque written notice sixty days before said transfer or sale. The City of Albuquerque retains the right to deny the sale of the property associated with this deed, and the landowner must receive written permission from the City of Albuquerque before selling this land. Purchasers of the property subject to the conservation easement are bound by its terms, as are heirs of the original property owner in the event of its death. If the property is foreclosed, then both the foreclosing institution and purchaser in a foreclosure sale are also subject to the terms of this provision.

Subsequent Mortgages: This deed in no way impairs the property owner from receiving additional mortgages or liens against the property as long as these liens are subordinate to the provisions of this Deed.

Waiver: No portion of this deed shall be waived without the written consent of both parties.

Incorporation: Any recitals set forth at the beginning of this deed as well as any attached exhibits referenced herein shall be incorporated to this deed by this reference.

Interpretation: Any interpretations of the contents of this deed shall be governed by the laws of the State of New Mexico. Furthermore any interpretations of the content of this deed shall be done so without regard to the authorship of the contents, but rather with regards to maximizing the proposed conservational and protectoral values associated with this deed.

No Third Party Beneficiaries: This deed was entered into by the landowner and the City of Albuquerque and was intended for their sole benefit. No rights or responsibilities shall be created in any third party pursuant to this Deed.

Appendix D. Private Preservation Options

Counterparts: This deed can be broken into two or more parts, each of which shall be executed by both parties, and each part will be considered an original document, but in the aggregate this deed shall still be considered a single agreement.

Severability: If any provision of this deed is found to be illegal, this illegal content shall not affect any other provision of this deed, and the deed shall still remain legally enforceable.

Integration: This deed sets forth all provisions of the agreements between the landowner and the City of Albuquerque and supersedes any prior and subsequent negotiations, understandings, documents, or agreements relating to this deed.

Recording: the City of Albuquerque shall record this deed in a timely fashion in the official records of Bernalillo County, New Mexico. The City of Albuquerque shall also re-record this deed anytime there are changes to any provision or other information contained in this deed in order to preserve the rights and protections of this deed.

Acceptance: The City of Albuquerque has accepted the easement conveyed by this deed and the rights and responsibilities contained herein. The City of Albuquerque agrees to have and to hold this Deed of Conservation Easement unto the City of Albuquerque forever in perpetuity.

Reviewed by:

(City Attorney)

APPENDIX

Appendix D. Private Preservation Options

Signatures and Acknowledgements:

The landowner:

(Print name)

County of _____)

_____) SS
State of _____)

The foregoing Deed was acknowledged before me on the day
of _____ by _____

(Notary Public Seal)

My Commission Expires: _____

The City of Albuquerque,
A New Mexico Municipality

(Print Name of Representative)

County of _____)

_____) SS
State of _____)

The foregoing Deed was acknowledged before me on the day
of _____ by _____, representative of
the City of Albuquerque

(Notary Public Seal)

My commission expires: _____

Appendix E

Fiscal Impact Analysis

This Page Left Intentionally Blank

Volcano Heights Sector Development Plan: Fiscal Impact Analysis

August 2013



Prepared For: City of Albuquerque



A GATEWAYPLANNING and Balfour Beatty Company

Table of Contents

- I. Introduction.....1
- II. Understanding and Assumptions1
- III. Analysis Assumptions1
- IV. Development Scenario Value5
- V. Fiscal Impact.....7
- VI. Current and Projected Property Value7
- VII. Implementation and Conclusion.....7

This study was prepared to gauge the fiscal impact of potential development as envisioned by the Volcano Heights Sector Development Plan. There are several real challenges to development in this 570-acre greenfield area. Going from a completely undeveloped area – with no utilities, roads, drainage, or water service available – to a high-density, high-intensity Major Activity Center represents a steep investment and a significant obstacle to initial investment and ultimate build out success. A series of infrastructure improvements is necessary to catalyze development and enable private investment to succeed in implementing the development vision for a walkable district. As the only development of its type on Albuquerque's West Side, there are also significant opportunities for profit and benefits to the expanded marketability for employment west of the Rio Grande.

Because Volcano Heights is based on a new development pattern with a mix of uses supported by a multimodal transportation network, there is an extra value created by such development above and beyond what could typically be expected from traditional suburban development patterns. This extra value could be leveraged through public-private partnerships to successfully create a walkable job center and live/work district on Albuquerque's West Side.

Understandings and Assumptions

The Volcano Heights Sector Development Plan encompasses approximately 570 acres in northwest Albuquerque. Currently, Volcano Heights is entirely undeveloped, with a total land value of \$1,299,365, according to the Bernalillo County Assessor Office. Typically, a city's ability to shape development is limited to either upgrading infrastructure (e.g.

upgrading a road to a complete street with multimodal streetscape amenities, providing enhanced transit service, or providing other "horizontal" infrastructure improvements) or investing in catalytic projects (e.g. constructing a new civic development, redeveloping a historic property, or making other investments to "vertical" development).

In Volcano Heights, the City is in a unique position to guide development in this sector from the beginning. A strategic investment in a project that can act as a catalyst for private investment would be paid back both financially from the increased revenue from property taxes and gross receipts taxes as well as physically from laying the foundation for placemaking and high-quality development on the City's West Side.

This report compares the potential value of Volcano Heights' mixed-use development strategy to a traditional suburban single-use development pattern. The two development scenarios have been modeled using a proprietary development projection tool based on proven national growth patterns. Development has been projected over 15 years based on conservative estimates, market trends, inflation, and entitlements associated with each scenario.

As seen in **Table 1**, under the typical suburban model, the Plan area would build out over a 15-year period, with an approximate total development value of \$650 Million. Redevelopment could be expected in commercial areas on a 12- to 15-year cycle. The majority of land would be tied up with suburban residential development, which would either significantly limit or even eliminate the potential for future redevelopment.

With the proposed mixed-use entitlement scenario, a greater amount of land would be developed as large parcels. Because this initial development will set the pattern for an urban, walkable district, as the market changes or new uses become desirable, new development or redevelopment can easily be added or upgraded, which in turn further strengthens the sense of place and increases the level of activity and viability for all existing uses. The idea is not to create a new downtown, but to instead balance density

Please Continue to Page 4



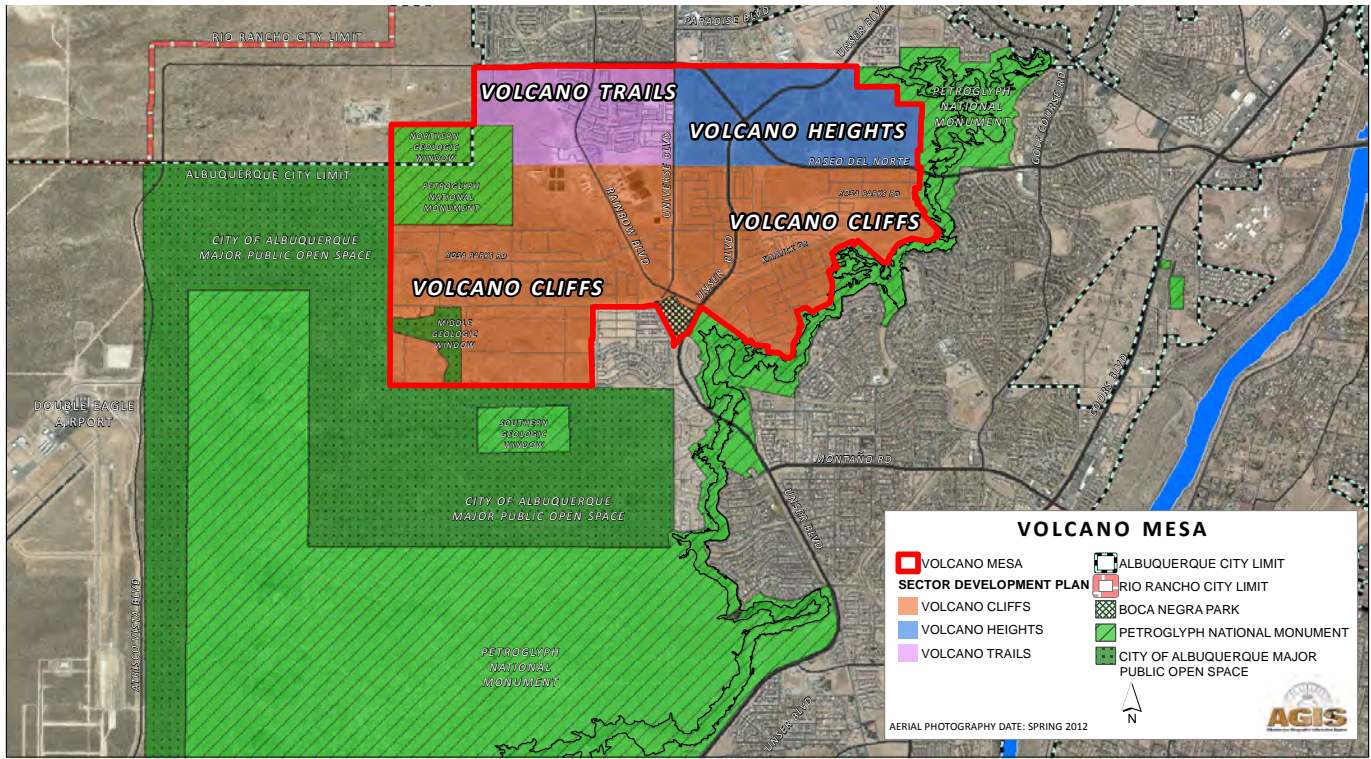

Figure 1: Volcano Mesa Sector Development Areas

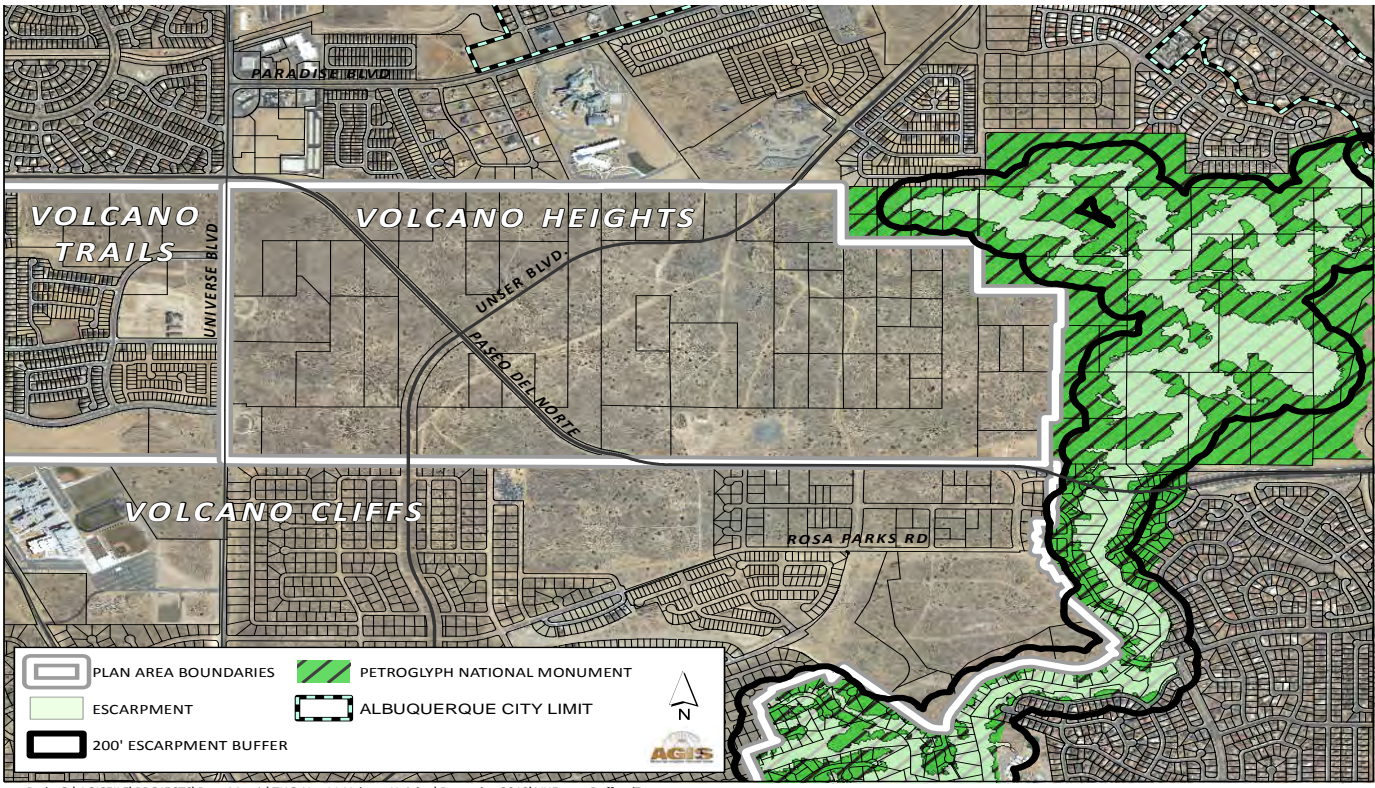

Figure 2: Volcano Heights Sector Area

Land Use Type	SQFT	Units	Value
Single Family Residential	-	2,102	\$420,376,000
Townhouse Residential	-	379	\$65,592,750
Multifamily	-	759	\$82,698,300
Suburban Commercial	918,027	-	\$82,622,430
Total	918,027	3,240	\$648,289,480

Table 1: Potential of Existing Suburban Entitlement Value at 15-Years without Inflation

Land Use Type	SQFT	Units	Value
Single Family Residential	-	364	\$72,800,000
Townhouse Residential	-	291	\$48,015,000
Multifamily	-	4,114	\$448,426,000
Hotel	53,600	-	\$7,772,000
Office	1,180,135	-	\$135,715,525
Regional Retail	326,700	-	\$29,403,000
Specialty Retail	322,198	-	\$33,186,394
Local Retail	170,600	-	\$15,865,800
Total	2,053,233	4,769	\$791,183,719

Table 2: Potential Mixed-Use Entitlement Total Value at 15-Years without Inflation



15-year Development Cycle		
	Existing Suburban	Mixed-Use Place
Net New Residents	8,067	10,664
Net New Jobs	1,469	4,323

Table 3: Projected New Growth

Assumptions Table		
Residential Occupancy:	92%	
Commercial Occupancy:	85%	
Average MF Unit Size	1000	Sqft
Average SF Unit Size	2000	Sqft
Hotel Room Size:	300	Sqft
Avg. Residents Per MF Unit	2.4	People
Avg. Residents Per SF Unit	2.8	People
Inflation Rate	2%	per year

Table 4: Analysis Assumptions

and height to achieve a critical mass of activity, creating a place that people want to visit or live, given their own preferences or desires. Instead of competing or clashing with existing development as it might in a traditional suburban context, new developments or redevelopment add to the success of the area as a whole and to each business and residential project.

At the end of the assumed 15-year buildout cycle, the mixed-use entitlement has already surpassed the value of the traditional suburban entitlement and has the potential to grow or stay stable over time, as shown in **Table 2**. Given that a critical mass has been created through placemaking efforts, the potential for redevelopment is stronger,

and the cost of services per user is lower than the traditional model.

Table 3 demonstrates estimated population and employment impact for the two development scenarios.

Table 4 shows the assumptions used in the calculations. Base data were derived from a number of sources, including Bernalillo County and the City of Albuquerque.

Development Scenario Value

The two development scenarios project two very different built environments that have diverging

Please Continue to Page 6

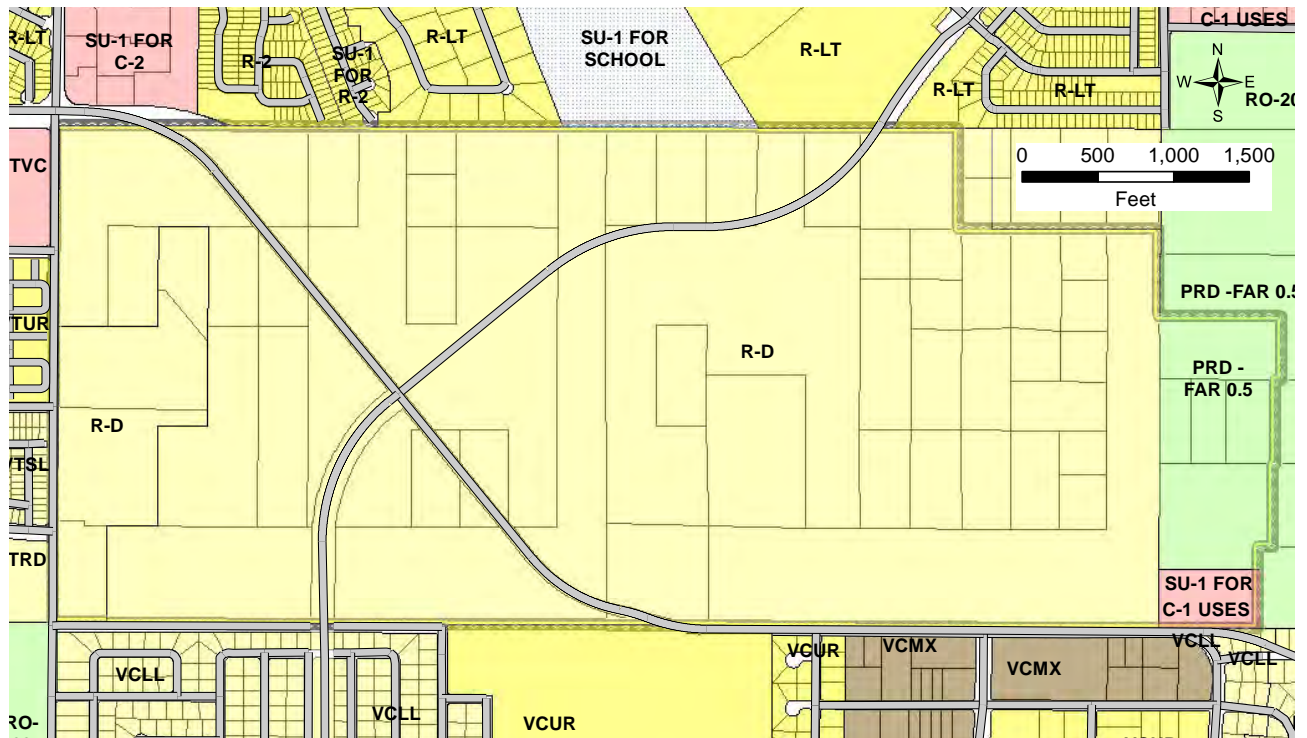

Figure 3: Pre-existing Zoning

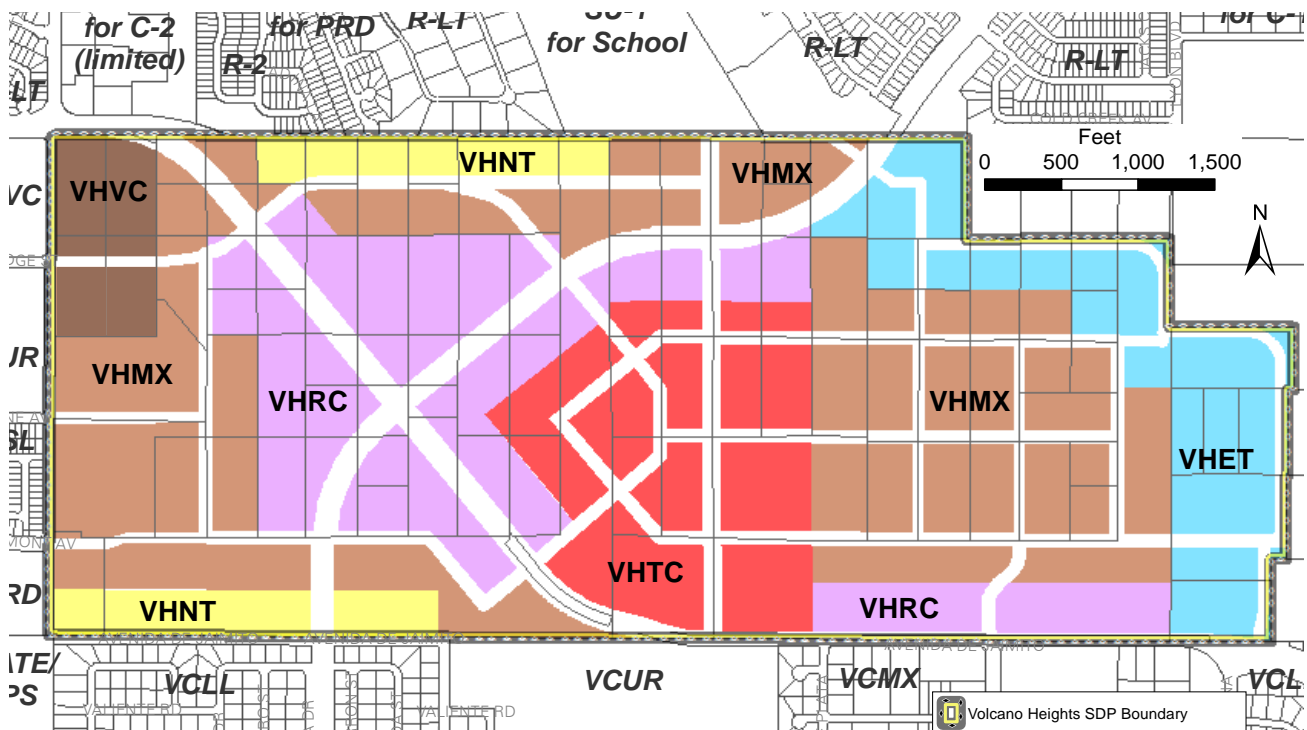
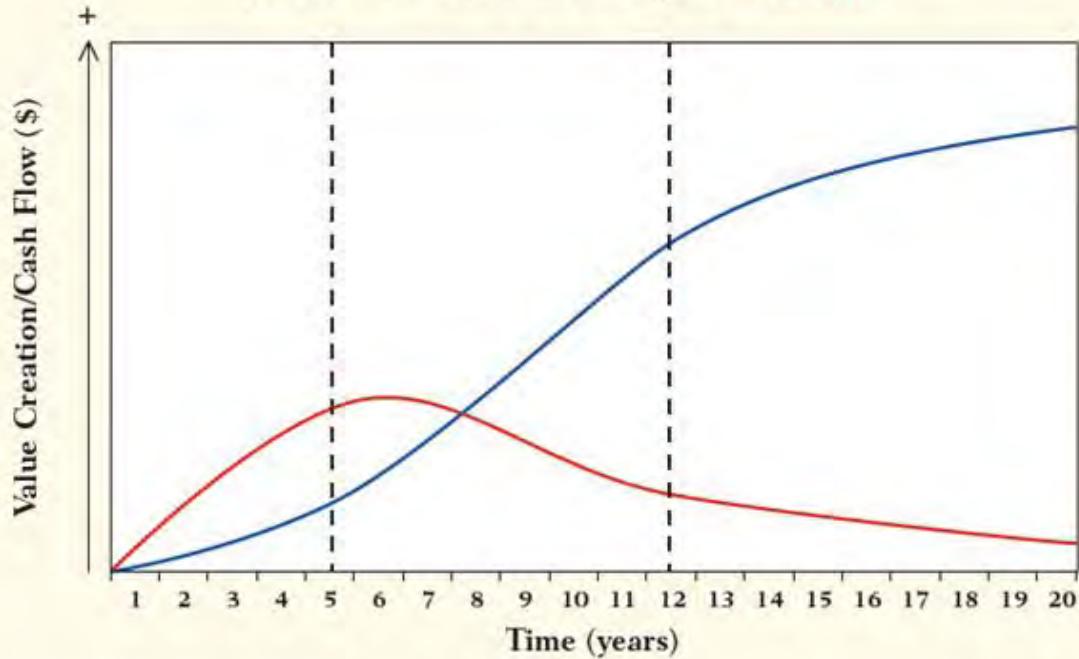

Figure 4: Adopted Zoning Map



Financial Characteristics of Downtowns with Critical Mass (Blue) versus Suburban Development (Red)



Source: Christopher B. Leinberger, Arcadia Land Co. and Robert Charles Lesser & Co.

Figure 5: Value of Development Types

values over time. **Figures 6 and 7** assume the average development values over the course of 15 years. The suburban entitlement model is assumed to have a build out with equal investment amounts over 15 years. This projection amount reflects the average accounting for fluctuations over two to three real estate cycles. The value reaches a peak after one real estate cycle, after which new investment moves to another greenfield development opportunity. After that point, values decline dramatically in commercial areas and more slowly in residential areas.

In contrast, the mixed-use entitlement model depicts growth over 15 years in a pattern that is typical of place-based environments, where growth builds slowly to a tipping point. Momentum is gained once the “place” is established and provides the foundation for future value, as shown in **Figure 5**. Because entitlements in Volcano

Heights allow a mix of uses, existing development can be repurposed to meet changing market opportunities. Form-based codes allow evolution from one real estate cycle to the next, allowing additional investment within a developed area available through a streamlined administrative approval process. These form-based codes ensure the level of quality from one project to the next, protecting property values and offering predictability for investors and neighbors. The adaptability of the mixed-use development model removes the potential ceiling on value and minimizes the likelihood of disinvestment and decline over time.

Current and Projected Development Value

According to the Bernalillo County Tax Assessor, the current appraised value for 562 unimproved

Please Continue to Page 8

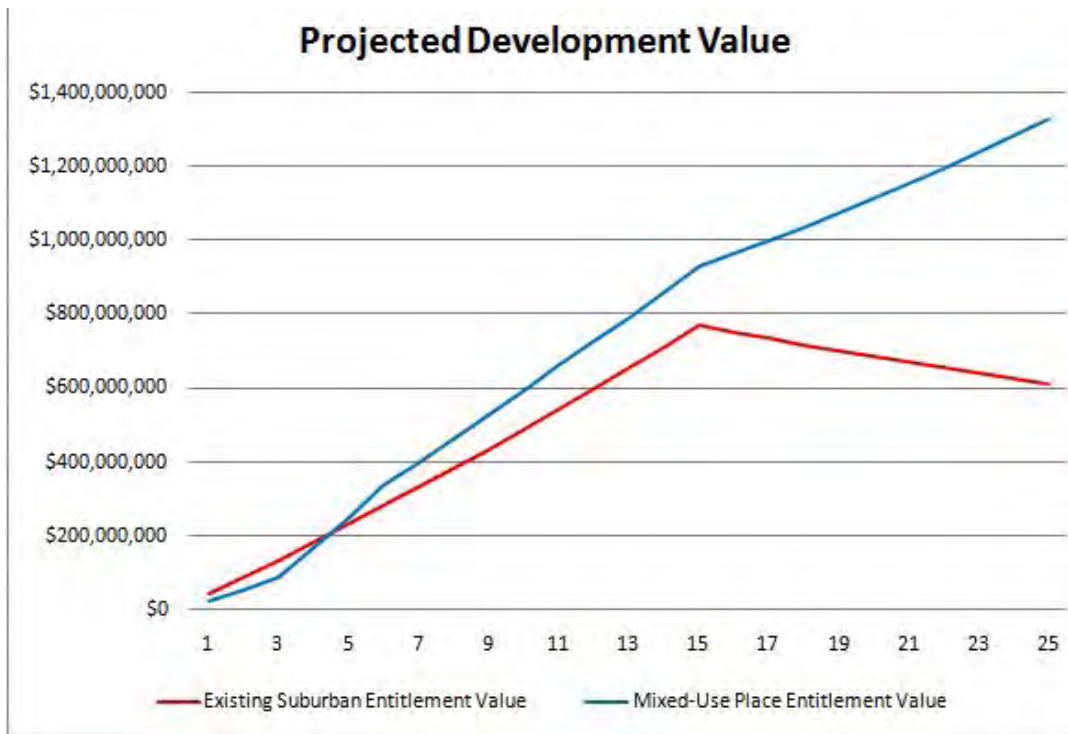

Figure 6: Property Value Comparison

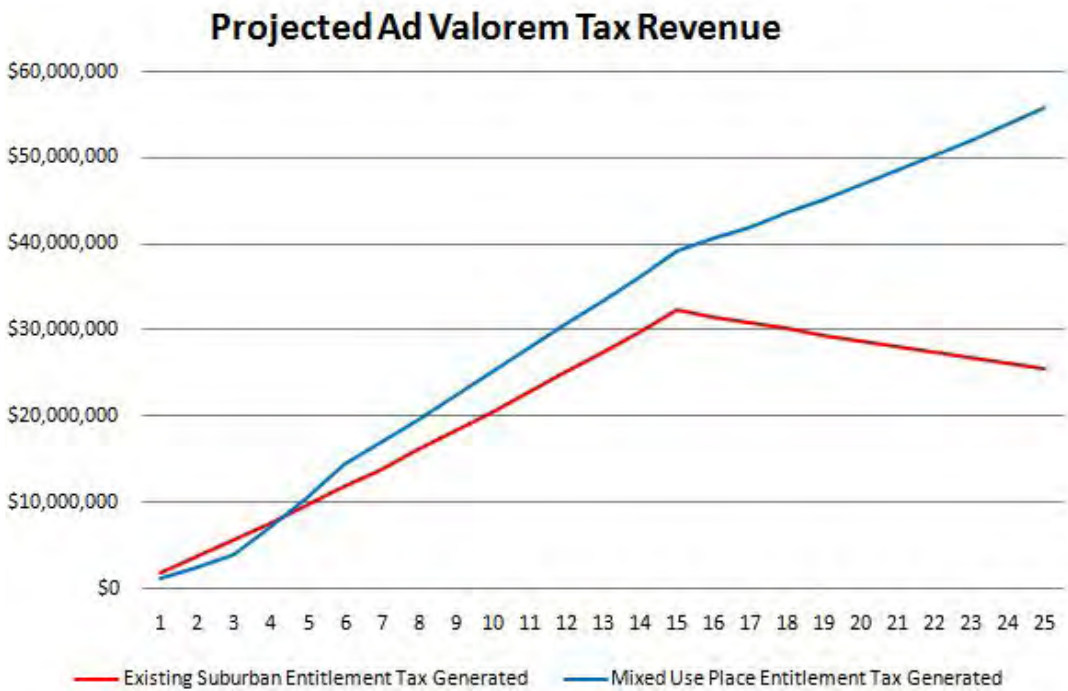

Figure 7: Ad Valorem Tax Revenue Comparison



Implementation and Conclusion

acres in Volcano Heights is \$1,299,365. After 15 years, under the suburban entitlement scenario, the value of development (i.e. projected ad valorem value) is approximately \$769 million. Under the mixed-use entitlement model, this value is approximately \$932 million, an increase of over 20%, as seen in **Figure 6**.

Current and Projected Ad Valorem Tax Revenue

Figure 7 shows the anticipated ad valorem tax revenue that will be generated per year over 25 years. Assuming no change in property tax rates, suburban entitlements provide approximately \$530 million in ad valorem tax revenue, while the mixed-use development model provides approximately \$769 million, almost a 45% increase in value. Common exemptions, such as a Homestead exemption, were not deducted from the projected Ad Valorem tax revenue estimation.

Detailed revenue projections are shown in **Table 5**.

Implementation

Once the Sector Development Plan is adopted and sets the entitlements, regulations, and policies in place to focus on placemaking and mixed-use development, various City departments and outside agencies can analyze the infrastructure needed to support the development vision. This includes the City Department of Municipal Development for roads and storm drainage infrastructure, Public Service Company of New Mexico for electric utilities, New Mexico Gas for gas utilities, the Albuquerque Bernalillo County Water Utility Authority for water and wastewater, and cable and internet service providers. Enforceable policies and regulations are needed in order to create accurate assumptions about what infrastructure will be required to support desired development patterns.

Once infrastructure costs have been estimated, the City should consider strategic investments that could best catalyze and leverage private investment. Mixed-use development is expected to

require more costly infrastructure than suburban development. Knowing the additional value of these mixed-use environments, the City can consider which portion of the additional cost makes sense to support, given the expected levels of return over and above typical suburban development. These decisions can be made on a rational basis, and the potential revenues should justify some measure of support or initial catalytic infrastructure project in Volcano Heights.

Conclusion

Cities across the United States have discovered that the high initial investment and steep drop off of value typical of the suburban development pattern leads to long-term fiscal liability that exceeds tax income over the lifecycle of development and infrastructure. Many cities are moving instead to a model of public-private partnerships that lay a foundation to create a sense of “place” in which initial investments are more than recovered by the long-term value as the area continues to produce value over time. This mixed-use model is a solution to the suburban model of short-term gain that jeopardizes long-term value.

As this report indicates, the potential for better outcomes is compelling, and the City should carefully consider how to invest in Volcano Heights’ success to reap the financial benefits, as well as the enhanced opportunities for economic development and placemaking, this model offers. This opportunity truly represents a win-win for development. The use of special districts, such as Public Improvement Districts (PIDs), Special Assessment Districts (SADs), or Tax Increment Development Districts (TIDDs) could ensure that capital improvements are focused on economic and catalytic impact, rather than simply reconstructing aging infrastructure at the end of its lifecycle. By investing in appropriate catalytic improvements, the City can be the frontrunner in investment in the future of sustainable value in Volcano Heights.

Development Analysis Tool

Volcano Heights Albuquerque

2013-2038

Revenue Projection

Period	Base	1	2	3	4	5	6	7	8	9	10	11	12	13	14	15	15-Year Total
Conventional Build																	
Existing Conditions Taxable Value	1,299,365	1,299,365	1,299,365	1,299,365	1,299,365	1,299,365	1,299,365	1,299,365	1,299,365	1,299,365	1,299,365	1,299,365	1,299,365	1,299,365	1,299,365	1,299,365	19,490,475
Conventional Build Value		43,219,299	43,219,299	43,219,299	43,219,299	43,219,299	43,219,299	43,219,299	43,219,299	43,219,299	43,219,299	43,219,299	43,219,299	43,219,299	43,219,299	43,219,299	648,289,480
Conventional Total Value		44,518,664	89,927,701	136,244,918	183,488,480	231,676,914	280,829,116	330,964,362	382,102,312	434,263,022	487,466,946	541,734,949	597,088,312	653,548,742	711,138,380	769,879,811	769,879,811
State	1,767	60,545	122,302	185,293	249,544	315,081	381,928	450,112	519,659	590,598	662,955	736,760	812,040	888,826	967,148	1,047,037	7,991,594
County	10,548	361,403	730,033	1,106,036	1,489,559	1,880,753	2,279,771	2,686,769	3,101,907	3,525,347	3,957,257	4,397,804	4,847,163	5,305,509	5,773,021	6,249,884	47,702,764
City	14,969	512,855	1,035,967	1,569,541	2,113,787	2,668,918	3,235,151	3,812,709	4,401,819	5,002,710	5,615,619	6,240,787	6,878,457	7,528,882	8,192,314	8,869,015	67,693,501
School APS	13,595	465,799	940,914	1,425,531	1,919,840	2,424,036	2,938,315	3,462,880	3,997,936	4,543,694	5,100,367	5,668,173	6,247,335	6,838,080	7,440,641	8,055,252	61,482,388
CNM	4,345	148,870	300,718	455,603	613,585	774,728	939,093	1,106,745	1,277,750	1,452,176	1,630,089	1,811,562	1,996,663	2,185,467	2,378,047	2,574,478	19,649,919
UNMH	8,316	284,919	575,537	871,967	1,174,326	1,482,732	1,797,306	2,118,172	2,445,455	2,779,283	3,119,788	3,467,104	3,821,365	4,182,712	4,551,286	4,927,231	37,607,501
AMAFCA	1,106	37,885	76,528	115,944	156,149	197,157	238,986	281,651	325,169	369,558	414,834	461,016	508,122	556,170	605,179	655,168	5,000,622
Total Tax Generated	54,646	1,872,277	3,781,999	5,729,916	7,716,792	9,743,404	11,810,549	13,919,037	16,069,695	18,263,366	20,500,910	22,783,205	25,111,146	27,485,646	29,907,636	32,378,065	247,128,289
Mixed Use Build																	
Existing Conditions Taxable Value	1,299,365	1,299,365	1,299,365	1,299,365	1,299,365	1,299,365	1,299,365	1,299,365	1,299,365	1,299,365	1,299,365	1,299,365	1,299,365	1,299,365	1,299,365	1,299,365	19,490,475
Mixed Use Build Value		24,294,267	26,508,308	33,008,308	76,037,620	76,037,620	84,351,620	53,557,354	53,557,354	53,557,354	53,557,354	53,557,354	51,343,313	51,343,313	51,343,313	51,343,313	793,397,760
Mixed Use Total Value		25,593,632	53,913,177	89,299,113	168,422,081	249,127,507	339,761,043	401,412,982	464,297,960	528,440,638	593,866,169	660,600,211	726,454,893	793,626,668	862,141,879	932,027,394	932,027,394
State	1,767	34,807	73,322	121,447	229,054	338,813	462,075	545,922	631,445	718,679	807,658	898,416	987,979	1,079,332	1,172,513	1,267,557	9,370,787
County	10,548	207,769	437,667	724,930	1,367,250	2,022,417	2,758,180	3,258,671	3,769,171	4,289,881	4,821,006	5,362,753	5,897,361	6,442,661	6,998,868	7,566,198	55,935,331
City	14,969	294,839	621,080	1,028,726	1,940,222	2,869,949	3,914,047	4,624,278	5,348,713	6,087,636	6,841,338	7,610,114	8,368,760	9,142,579	9,931,874	10,736,956	79,376,080
School APS	13,595	267,786	564,094	934,337	1,762,200	2,606,621	3,554,920	4,199,984	4,857,950	5,529,074	6,213,622	6,911,860	7,600,898	8,303,716	9,020,590	9,751,803	72,093,049
CNM	4,345	85,585	180,286	298,616	563,203	833,082	1,136,161	1,342,325	1,552,612	1,767,105	1,985,888	2,209,047	2,429,265	2,653,888	2,883,002	3,116,700	23,041,112
UNMH	8,316	163,799	345,044	571,514	1,077,901	1,594,416	2,174,471	2,569,043	2,971,507	3,382,020	3,800,743	4,227,841	4,649,311	5,079,211	5,517,708	5,964,975	44,097,822
AMAFCA	1,106	21,780	45,880	75,994	143,327	212,008	289,137	341,602	395,118	449,703	505,380	562,171	618,213	675,376	733,683	793,155	5,863,632
Total Tax Generated	54,646	1,076,366	2,267,373	3,755,564	7,083,159	10,477,306	14,288,990	16,881,824	19,526,515	22,224,099	24,975,636	27,782,202	30,551,787	33,376,763	36,258,239	39,197,344	289,777,814

Table 5: Revenue Projections

Development Analysis Tool											
Volcano Heights Albuquerque											
2013-2038											
Revenue Projection											
Period	16	17	18	19	20	21	22	23	24	25	25-Year Total
Conventional Build											
Existing Conditions Taxable Value	1,299,365	1,299,365	1,299,365	1,299,365	1,299,365	1,299,365	1,299,365	1,299,365	1,299,365	1,299,365	32,484,125
Conventional Build Value	0	0	0	0	0	0	0	0	0	0	648,289,480
Conventional Total Value	751,932,181	734,433,242	717,371,775	700,736,846	684,517,790	668,704,210	653,285,970	638,253,186	623,596,221	609,305,681	609,305,681
State	1,022,628	998,829	975,626	953,002	930,944	909,438	888,469	868,024	848,091	828,656	17,215,300
County	6,104,185	5,962,129	5,823,624	5,688,582	5,556,915	5,428,541	5,303,376	5,181,339	5,062,354	4,946,344	102,760,153
City	8,662,259	8,460,671	8,264,123	8,072,488	7,885,645	7,703,473	7,525,854	7,352,677	7,183,828	7,019,201	145,823,721
School APS	7,867,466	7,684,375	7,505,861	7,331,810	7,162,110	6,996,652	6,835,331	6,678,043	6,524,687	6,375,165	132,443,888
CNM	2,514,461	2,455,945	2,398,891	2,343,264	2,289,027	2,236,147	2,184,588	2,134,319	2,085,306	2,037,518	42,329,386
UNMH	4,812,366	4,700,373	4,591,179	4,484,716	4,380,914	4,279,707	4,181,030	4,084,820	3,991,016	3,899,556	81,013,178
AMAFCA	639,894	625,003	610,483	596,327	582,525	569,067	555,946	543,153	530,680	518,519	10,772,221
Total Tax Generated	31,623,260	30,887,324	30,169,787	29,470,189	28,788,080	28,123,024	27,474,595	26,842,376	26,225,963	25,624,960	532,357,847
Mixed Use Build											
Existing Conditions Taxable Value	1,299,365	1,299,365	1,299,365	1,299,365	1,299,365	1,299,365	1,299,365	1,299,365	1,299,365	1,299,365	32,484,125
Mixed Use Build Value	0	0	0	0	0	0	0	0	0	0	793,397,760
Mixed Use Total Value	965,947,718	1,001,055,253	1,037,391,552	1,074,999,621	1,113,923,973	1,154,210,677	1,195,907,416	1,239,063,540	1,283,730,129	1,329,960,049	1,329,960,049
State	1,313,689	1,361,435	1,410,853	1,461,999	1,514,937	1,569,727	1,626,434	1,685,126	1,745,873	1,808,746	24,869,606
County	7,841,564	8,126,567	8,421,545	8,726,847	9,042,835	9,369,882	9,708,376	10,058,718	10,421,321	10,796,616	148,449,601
City	11,127,718	11,532,157	11,950,751	12,383,996	12,832,404	13,296,507	13,776,853	14,274,012	14,788,571	15,321,140	210,660,188
School APS	10,106,711	10,474,041	10,854,228	11,247,721	11,654,987	12,076,506	12,512,779	12,964,322	13,431,668	13,915,372	191,331,384
CNM	3,230,129	3,347,529	3,469,037	3,594,799	3,724,962	3,859,681	3,999,114	4,143,428	4,292,794	4,447,386	61,149,971
UNMH	6,182,065	6,406,754	6,639,306	6,879,998	7,129,113	7,386,948	7,653,807	7,930,007	8,215,873	8,511,744	117,033,438
AMAFCA	822,022	851,898	882,820	914,825	947,949	982,233	1,017,717	1,054,443	1,092,454	1,131,796	15,561,790
Total Tax Generated	40,623,897	42,100,380	43,628,539	45,210,184	46,847,187	48,541,484	50,295,082	52,110,056	53,988,554	55,932,800	769,055,977

This Page Left Intentionally Blank



A GATEWAYPLANNING and **Balfour Beatty** Company

3100 McKinnon Street, 7th Floor
Dallas, TX 75201
o. 817.348.9500 f. 214.451.1176

www.vialtagroup.com