

VOLCANO
HEIGHTS



Sector Development Plan

APPENDIX

Originally Adopted August 2013

Amended November 5, 2014

Table of Contents

APPENDIX

Appendix A. Pre-existing Conditions

Appendix B. Sector Planning Process

Appendix C. 2013 Access Resolution for Paseo del Norte and Unser Boulevard and Traffic Study

Appendix D. Private Preservation Options

Appendix E. Fiscal Impact Analysis

Appendix A

Pre-existing Conditions

Appendix A. Pre-existing Conditions

A. Environment and Open Space

Volcano Heights lies between publicly owned lands preserving the volcanic Northwest Escarpment to the east and lands protecting the volcanoes and geologic windows farther west. (See **Exhibit A.1.**) Arroyos connect the Petroglyph National Monument with City-owned Major Public Open Space, generally running west to east from the geologic windows to the Northwest Escarpment. (See **Exhibit A.2.**)

Volcano Heights provides a unique portal into New Mexico's rich interplay of cultures. Most Albuquerque residents recognize the Petroglyph National Monument as an important asset and associate it with the five volcanic cones and the 17-mile Escarpment containing petroglyphs.

The Petroglyph National Monument was created by an act of the United States Congress in 1990 to preserve over 10,000 acres of sensitive lands, unique volcanic landscape, petroglyphs, and other culturally-significant features in perpetuity.

The Petroglyph National Monument includes more than 20,000 petroglyphs carved between 700 to 3,000 years ago. A 2002 National Park Service ethnographic study — “That Place People Talk About: The Petroglyph National Monument, Ethnographic Landscape Report,” by Anschuetz, et al. (hereinafter referred to as “Ethnographic Landscape Report”) — illuminates the ongoing religious and cultural value these sacred places hold for many Native Americans.

This rich document explores the meaning of the Northwest Mesa volcanic area for Pueblo and other Native American and Hispanic people. Because of space limitations, the present document approaches the meaning of the West

Mesa area from the Rio Grande Pueblos' perspective; for other perspectives, the reader is encouraged to read the entire Ethnographic Landscape Report.

The legal boundaries of the Petroglyph National Monument were constrained by the financial resources available at the time for land acquisition. For the Pueblos, the important areas include the entire lava bed, the volcanoes' caves and shafts, the petroglyphs, and additional features of comparable importance in meaning and use. The Ethnographic Landscape Report states, “Land-use planning in the face of development, to be successful, needs to consider how to sustain extant landscape traditions within an ongoing historical process” (Anschuetz 2002: 3.31, 9.9).

1. Petroglyphs

According to the Ethnographic Landscape Report, the petroglyphs focus Pueblo people's concentration and prayer. Not just representations of specific animals or people, the images are used to transmit thought, energy, and learning across space and time into other dimensions within a defined and bounded world.

As Celestino Gachupin of Zia Pueblo said, “The petroglyphs... belong to all of us now, not only the native people....The individual family that has a home that abuts the Monument... you are our eyes and ears now, as far as ensuring that nothing bad happens to the place.”

2. Shrines, Caves, Lava Tubes in Volcanoes, Recesses in the Escarpment Face, and Elsewhere

Various other West Mesa sites function with the petroglyphs as in interlocking system of spiritual communication. The lava tubes and caves near

Appendix A. Pre-existing Conditions

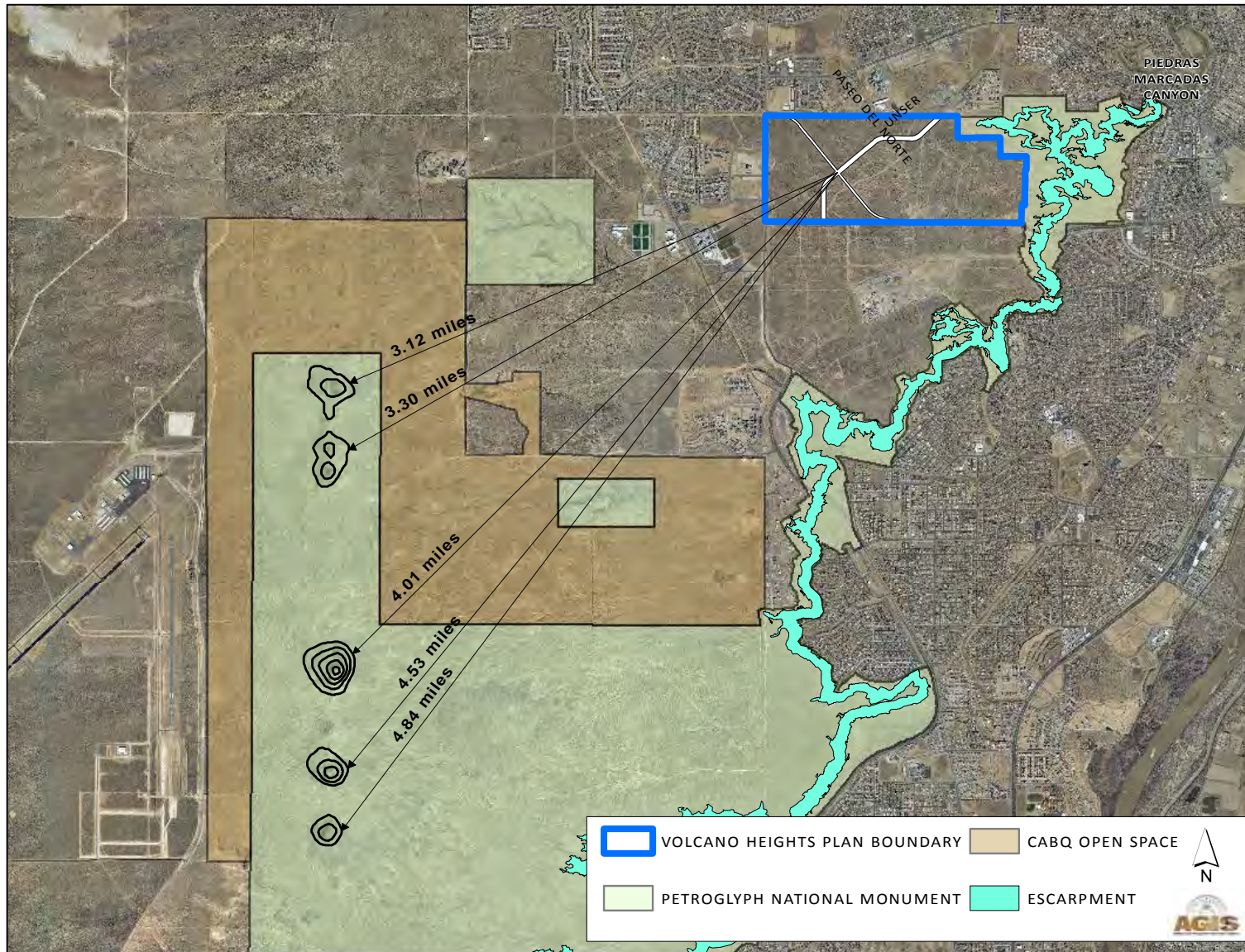

Path: Q:\AGISFILE\PROJECTS\PetraMorris\THG-Nov11-VolcanoHeights\December2012\VH_views.mxd

Exhibit A.1 – Volcano Heights, Volcanoes, and Petroglyph National Monument

APPENDIX

Appendix A. Pre-existing Conditions

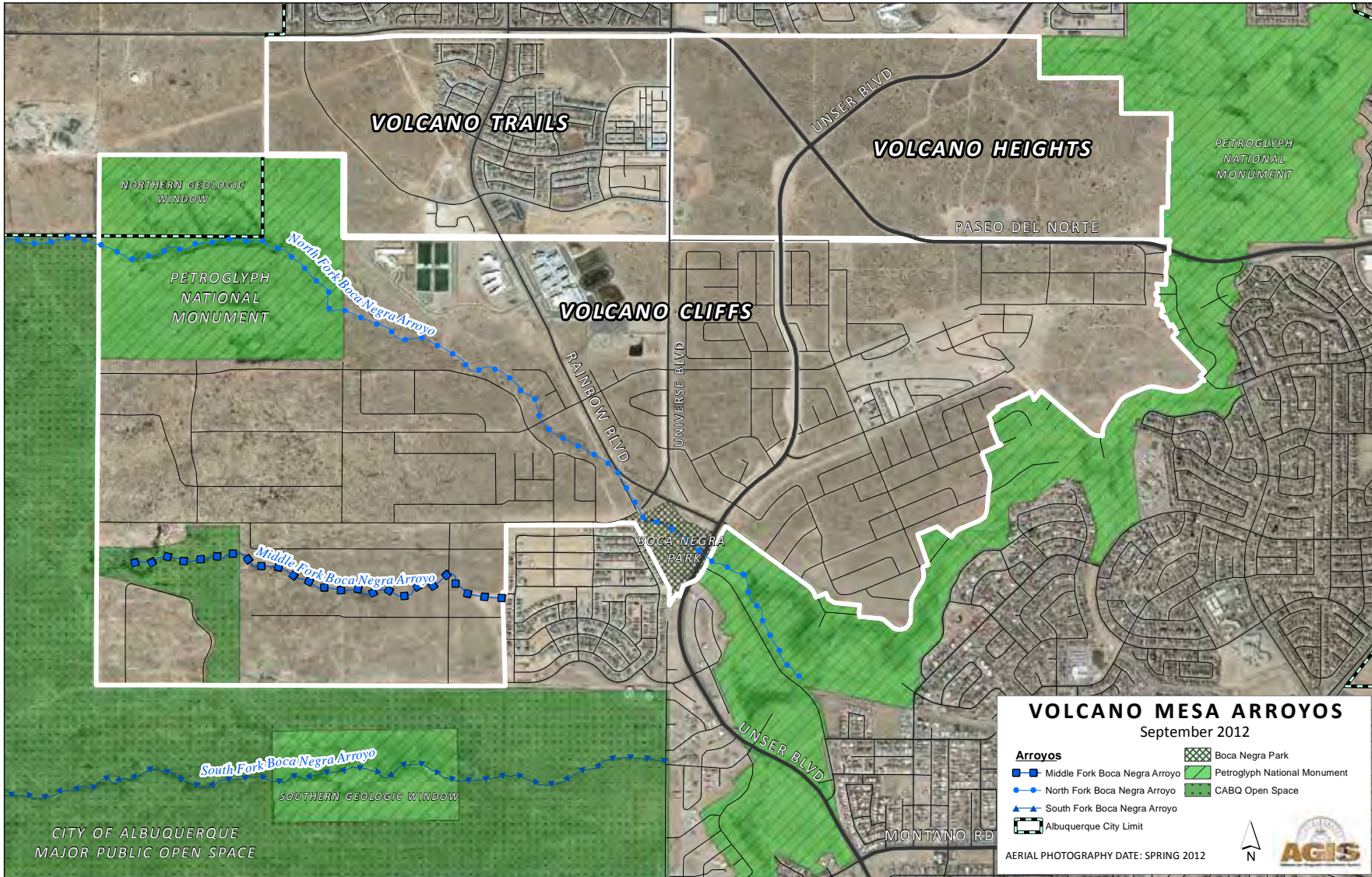

Path: Q:\AGIS\FILE\PROJECTS\PetraMorris\TNG-Nov15-VolcanoHeights\December2012\VCPlansArroyos.mxd
Exhibit A.2 – Arroyos in Volcano Mesa

Appendix A. Pre-existing Conditions

two northernmost Volcanoes west of the Plan area contained shell beads, pendants, turquoise, hematite, selenite, mica, colored pebbles, prayer sticks, and feathers. These are places “where the world breathes” and prayers are directed. Arrangements of stones, boulders with pecked ground facets, stone piles, prominent bounders, recesses in the Escarpment, or rock spires are similarly meaningful (Anschuetz 2002: 3.24-25).

The Pueblo World is often depicted as a bowl in the landscape with the community’s plaza at its center, extending to distant mountains, with upper and lower realms as the places of the gods, the deceased, water, breath, transformation, and more. (See **Exhibit A.3.**) The periphery of the traditional Pueblo world was defined by the Rio Grande, the West Mesa’s Volcanic cones, the Escarpment, the Sandia Mountains, and more distant mountains (Anschuetz 2002: 3.3, 3.8, 3.14).

3. Plazas

Plazas physically express the Pueblos’ center and open the villages to the landscape. Pueblo people channel blessings across the landscape through shrines and special places, and the blessings intersect with the upper and lower worlds, where they are transformed and gain increased power. As they return to the people, these strengthened blessings renew the cycle of life from the plaza center (Anschuetz 2002: 3.8-3.12).

4. The Sandia Mountains

On the edge of the bowl that forms the Pueblo World, the Sandias are the home for important shrines and the highest earth spirits, who protect the communities below and visit the West Mesa lava bed (Anschuetz 2002: 3.21-22).

5. Pathways

Trails connecting former villages along the Rio Grande with each other ran up the valley slopes and Escarpment, past the petroglyphs and shrines, to the volcanoes and mountains beyond. The trails were used for hunting, gathering, agricultural, and traditional and cultural activities. Because in Pueblo life, there is little separation of the functional from the spiritual, the paths form an interrelated flow of energy and movement along the trails that can be considered a ritual pilgrimage (Anschuetz 2010: 3.31, 3.33-34). There are concentrations of petroglyphs on Escarpment paths along the Boca Negra and Piedras Marcadas arroyos that lead to the volcanic cones.

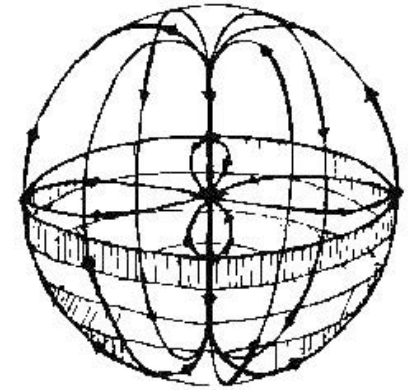

Exhibit A.3 – Diagrammatic Pueblo World View

6. Pueblo World View

Together, the elements described above constitute a world view that symbolizes a transformative healing process emanating from the West Mesa. In Pueblo terms, this is a significant place for reestablishing harmony with the environment, one another, and the spiritual dimensions of life. At the hearing to designate the Petroglyph National Monument, Pueblo members said, “We pray for peace, good health, harmony among all people, and a long and happy life” (Anschuetz 2002: 3.45-46).

7. Rock Outcroppings

The Plan area includes many outcroppings of basalt rock. Significant rock outcrops as defined in **Section 3.5** are mapped in **Exhibit 10.1** and also shown here in **Exhibit A.4**. Rock outcroppings have been used historically and culturally by Pueblo people as sacred sites. The basalt signals a place where upper and lower realms coexist and commune, and such outcroppings represent spaces of great liminal power, particularly as prayer sites.

APPENDIX

Appendix A. Pre-existing Conditions

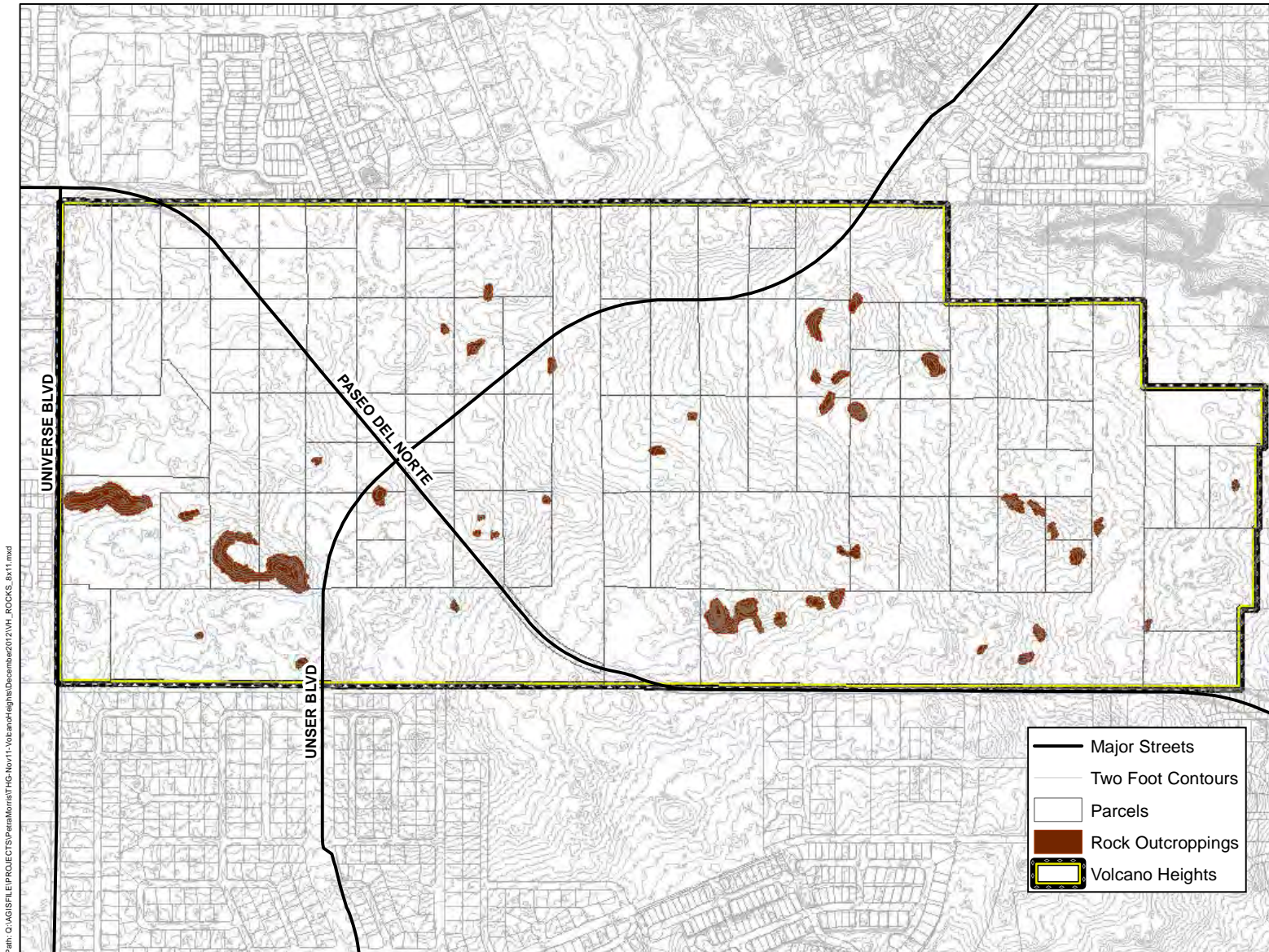

Exhibit A.4 – Significant Rock Outcroppings in Volcano Heights

Appendix A. Pre-existing Conditions

8. Soils and Geologic Conditions

Flows of basalt at varying depths and widths run through the Plan Area. These flows issued from volcanic fissures related to the subsidence of the Albuquerque basin approximately 190,000 years ago.

According to a June 1987 Albuquerque West Mesa Petroglyph Study by the National Park Service, "Soil has formed on West Mesa as the rocks have slowly weathered. The common parent materials are basalt and fine alluvial silt and sand. Sand is common in this environment and, if not part of the parent rock, is soon added by the wind. On the mesa top, soil varies in depth from 0 feet on the Escarpment rim and volcanic cones to more than 5 feet in broad areas of little slope."

According to the Northwest Mesa Escarpment Plan (NWMEP), soils in Volcano Heights are Alameda sandy loam at 0-5% slopes. Moderately deep and well drained, runoff is medium and water erosion is slight.

9. Drainage Channels

No named arroyos managed by the Albuquerque Metropolitan Arroyo Flood Control Authority (AMAFCA) lie within the Plan area. (See **Exhibit A.2.**) Water does flow to the northeast in the Plan area near Piedras Marcadas Canyon.

Drainage channels have played an important cultural role for prehistoric communities, connecting ceremonial sites on the volcanic mesa through the Escarpment to former Pueblo villages along the Rio Grande. Arroyos and drainage channels maintain rich habitat for plant and animal species along wildlife corridors that ecologically link the largest expanses of open space to each other.

Existing Open Space adjacent to the Plan does not have a fully developed formal trail system to link open space into a consolidated network. Drainage channels can be important corridors for walking and biking trails that could link natural open areas.

APPENDIX

Appendix A. Pre-existing Conditions

TABLE A.1 – POPULATION COMPARISON, 2000-2010

	2000 Population	2010 Population	Population Growth	Percent Change
Volcano Heights Study Area	50,761	91,217	40,456	80%
City of Albuquerque	448,607	545,852	97,245	22%
City of Rio Rancho	51,765	87,521	35,756	69%

Sources: 2010 Census SF 1 Data, MRCOG

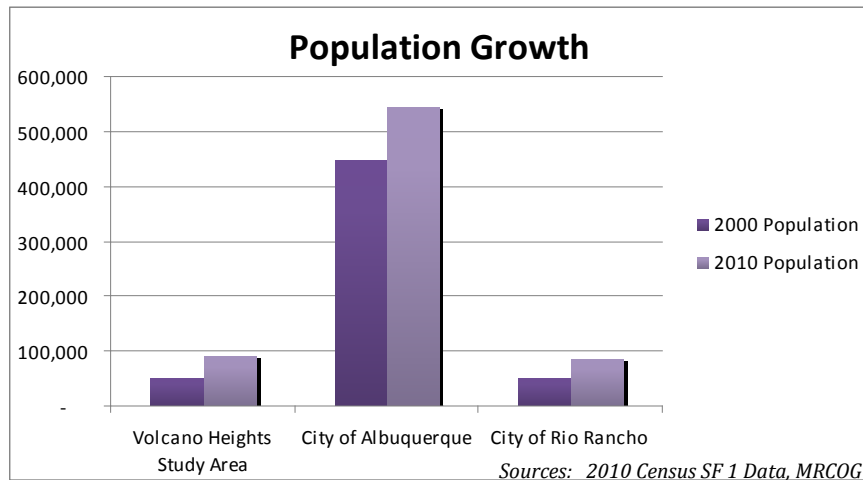

Exhibit A.5 – Comparative Population Growth , 2000-2010

TABLE A.2 – HOUSEHOLD SIZE, 2010

Geography	Average Household Size
Volcano Heights Study Area	2.7
City of Albuquerque	2.4
City of Rio Rancho	2.7

Sources: 2010 Census SF 1 Data, MRCOG

B. Demographics

1. Methodology

Because the land within Volcano Heights is undeveloped, City staff worked with the Mid-Region Council of Governments (MRCOG) to create a study area for Volcano Heights that could be compared to the larger geographies of the City of Albuquerque and the City of Rio Rancho.

MRCOG generated a 10-minute commute shed from the intersection of Paseo del Norte and Unser Boulevard using its Transportation Accessibility Model (TRAM) and current posted speeds. The 10-minute commute shed provides a study area of adequate size and coincides well with 2010 Census Tracts.

Nineteen (19) census tracts are included in the study area, shown in **Exhibit A.6**. Census tract 9406 west of Volcano Heights extends to Cibola County and includes tribal lands and other areas not comparable to the other census tracts. In order to avoid skewing figures for the Volcano Heights study area, MRCOG staff only incorporated individual census blocks out of tract 9406, including 4,603 residents in West Ventana Ranch.

2. Population

The Volcano Heights study area has a population comparable to the City of Rio Rancho, both just over 50,000 residents. (See **Exhibit A.5**.) The population within the City limits of Albuquerque is just under 450,000 people. Both Rio Rancho and the Volcano Heights study area show a high growth rate between 2000 and 2010, with 80% growth in Volcano Heights. The City of Albuquerque is growing more slowly but still shows significant growth in 10 years at almost 25%. (See **Table A.1**.)

Appendix A. Pre-existing Conditions

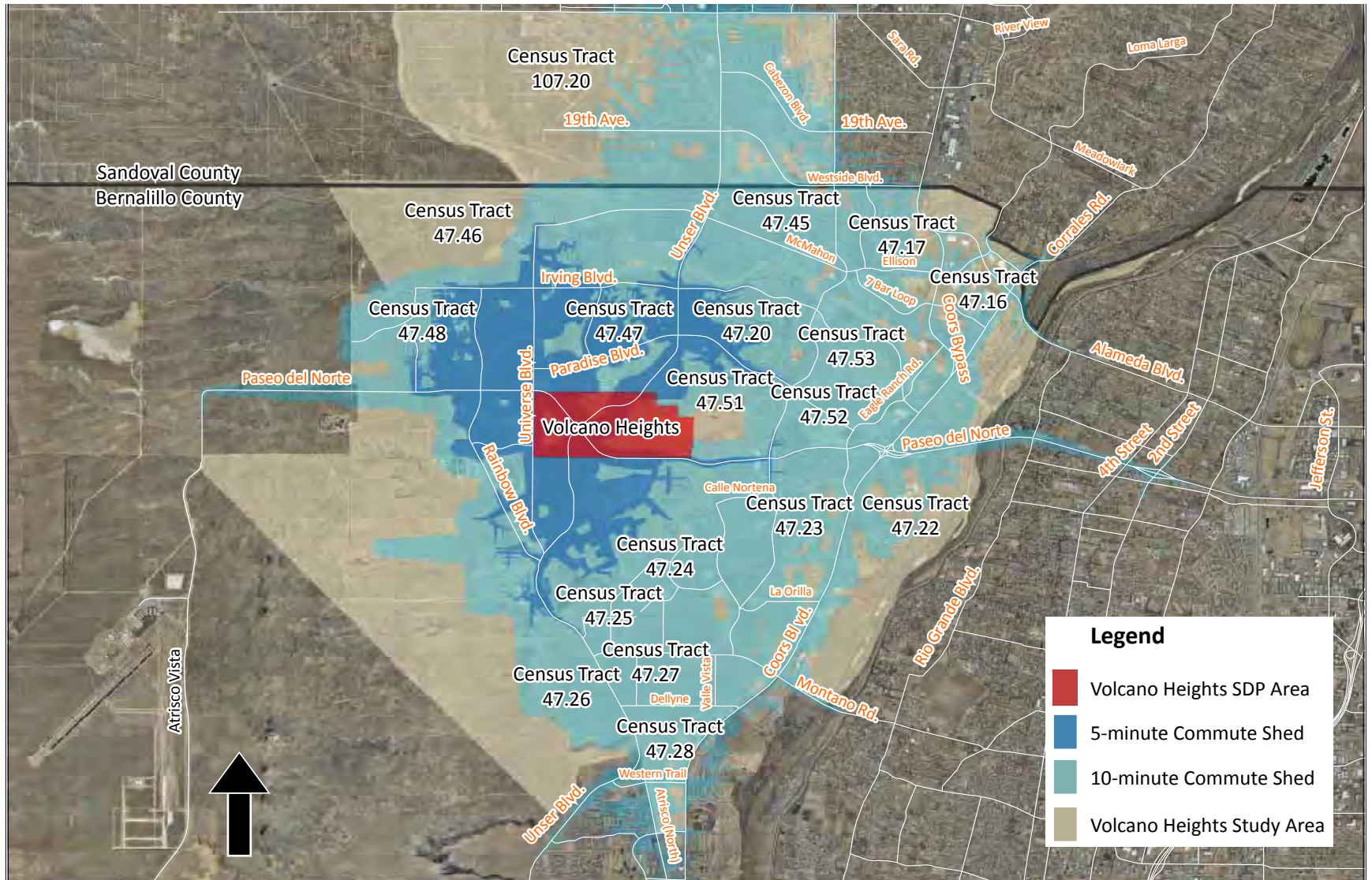

Source: AGIS and MRCOG

Exhibit A.6 – Volcano Heights Study Area

APPENDIX

Appendix A. Pre-existing Conditions

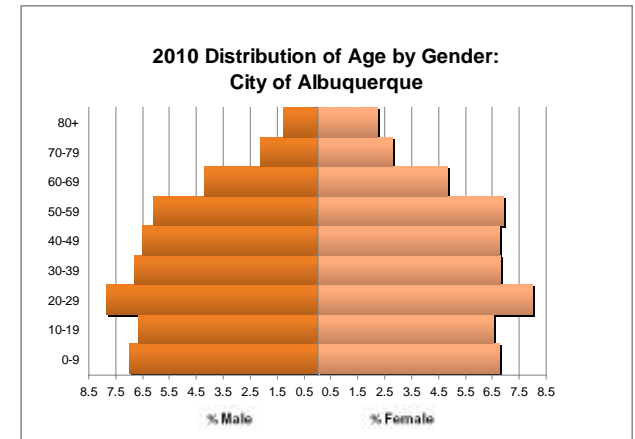
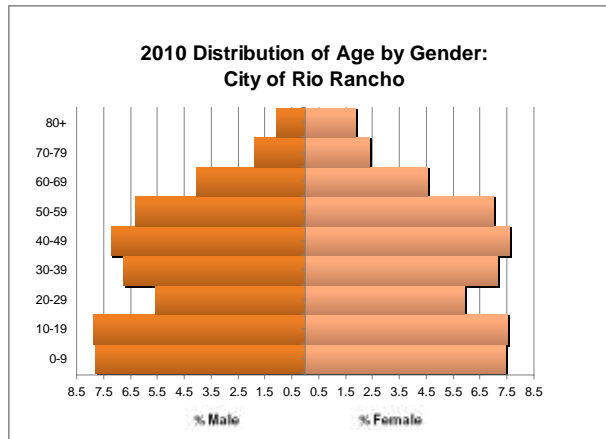
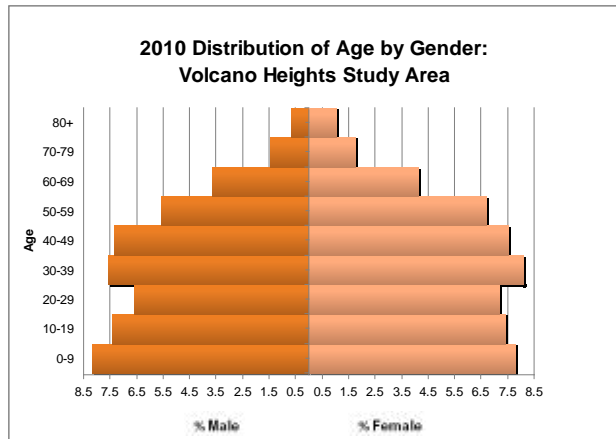

Exhibits A.7-9 – Population Pyramids, 2010: Volcano Heights Study Area, City of Rio Rancho, and City of Albuquerque

Sources: 2010 Census SF 1 Data, MRCOG

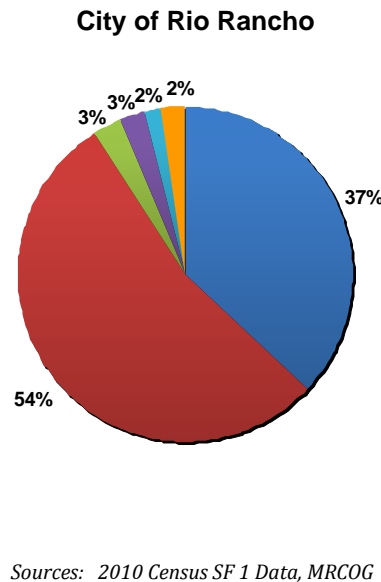
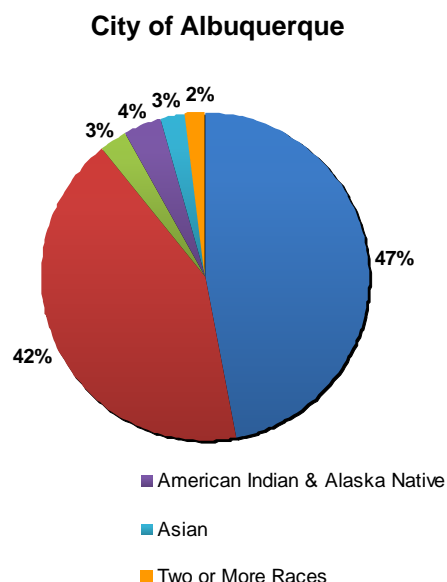
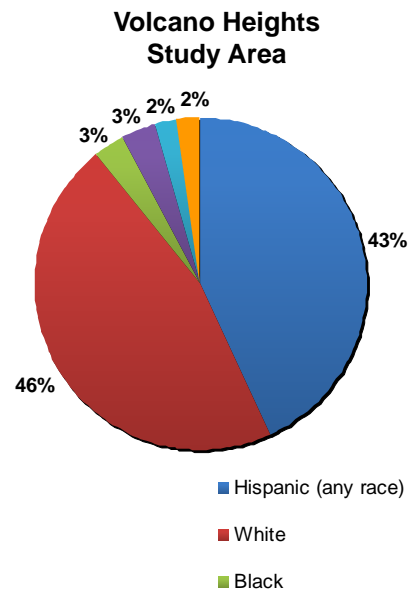

Sources: 2010 Census SF 1 Data, MRCOG

Exhibits A.10-12 – Race and Ethnicity, 2010: Volcano Heights Study Area, City of Albuquerque, and City of Rio Rancho

Population pyramids indicate growth conditions for Volcano Heights and Rio Rancho. (See **Exhibits A.7-9.**) There is a high percentage of the population in the child-bearing years, as well as a high percentage of young children that can lead to population growth over time. The dip in population for those 20-29, particularly in Rio Rancho, may indicate that people are leaving for college or jobs elsewhere.

In comparison, the population pyramid for the City of Albuquerque shows conditions for much slower rate of growth over time. The bump of population for those 20-29 may indicate that people are moving to Albuquerque for college or job opportunities.

In 2010, the Volcano Heights study area was 46% White and 43% Hispanic. (See **Exhibits A.10-12.**) Albuquerque was 47% Hispanic and 42% White. Rio Rancho was 54% White and only 37% Hispanic.

Appendix A. Pre-existing Conditions

TABLE A.3 – HOUSING UNITS COMPARISON, 2010

Area	Total Housing Units	Occupied Housing Units	Percent Occupied	Vacant Housing Units	Percent Vacant	Owner-Occupied Housing Units	Percent Owner-Occupied	Renter-Occupied Housing Units	Percent Renter-Occupied
Volcano Heights Study Area	35,726	33,896	95%	1,830	5%	24,596	73%	9,300	27%
City of Albuquerque	239,166	224,330	94%	14,836	6%	135,267	60%	89,063	40%
City of Rio Rancho	33,964	31,892	94%	2,072	6%	25,149	79%	6,743	21%

Sources: 2010 Census SF 1 Data, MRCOG

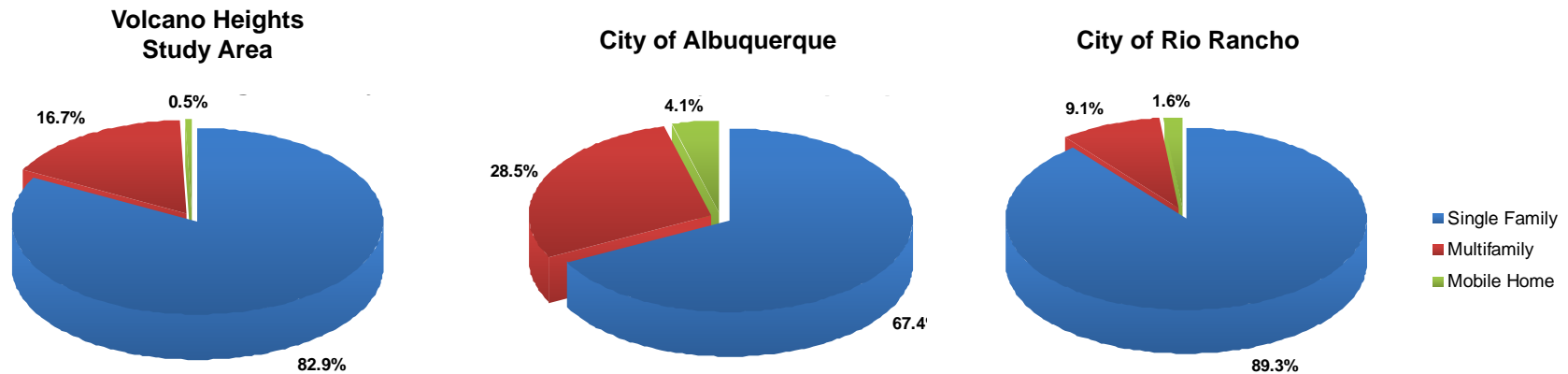

Sources: U.S. Census Bureau, American Community Survey 2006-2010, MRCOG

Exhibits A.13-15 – Housing Types, 2010: Volcano Heights Study Area, City of Albuquerque, and City of Rio Rancho

3. Housing

The three areas show a predominance of single-family housing. (See **Table A.3** and **Exhibits A.13-15**.) The City of Albuquerque has the highest percentages of multifamily and mobile homes. The Volcano Heights study area shows a higher portion of multifamily than Rio Rancho, while Rio Rancho shows a slightly higher portion of mobile homes than the Volcano Heights study area.

Both the Volcano Heights study area and Rio Rancho include approximately 35,000 housing units, while the City of Albuquerque includes almost 240,000. In all three cases, almost all units are occupied. Vacancy rates for all three are approximately 5%. The City of Rio Rancho has the highest proportion of owner-occupied units (79%), followed by the Volcano Heights study area (73%). The City of Albuquerque has the highest proportion of renter-occupied units (40%).

APPENDIX

Appendix A. Pre-existing Conditions

TABLE A.4 - HOUSING CONSTRUCTION YEAR, 2010

Year Structure Built	Volcano Heights Study Area		City of Albuquerque		City of Rio Rancho	
	Units	Percent	Units	Percent	Units	Percent
2005 or Later	3,715	12%	11,224	5%	5,139	16%
2000 - 2004	7,883	25%	27,532	12%	6,424	20%
1990 - 1999	11,519	36%	36,677	16%	7,856	25%
1980 - 1989	5,034	16%	35,359	15%	7,681	24%
1970 - 1979	2,895	9%	48,148	20%	4,021	13%
1960 - 1969	807	3%	25,928	11%	731	2%
1950 - 1959	133	0%	31,695	13%	92	0%
1940 - 1949	54	0%	10,786	5%	85	0%
1939 or Earlier	31	0%	7,542	3%	34	0%
Total Housing Units	32,071	100%	234,891	100%	32,063	100%

Sources: U.S. Census Bureau, American Community Survey 2006-2010, MRCOG

TABLE A.5 - HOUSEHOLD INCOME, 2010

Income Category	Volcano Heights Study Area		City of Albuquerque		City of Rio Rancho	
	Estimate	Percent	Estimate	Percent	Estimate	Percent
Less than \$10,000	891	3%	18,456	8%	1,177	4%
\$10,000 to \$14,999	645	2%	12,159	6%	1,005	3%
\$15,000 to \$24,999	1,872	6%	24,819	11%	2,632	9%
\$25,000 to \$34,999	2,563	8%	26,330	12%	2,477	8%
\$35,000 to \$49,999	4,195	14%	32,942	15%	5,007	17%
\$50,000 to \$74,999	7,318	24%	40,563	19%	6,694	23%
\$75,000 to \$99,999	5,265	17%	25,078	12%	4,669	16%
\$100,000 to \$149,999	5,021	16%	23,460	11%	4,356	15%
\$150,000 to \$199,999	1,894	6%	8,217	4%	975	3%
\$200,000 or more	790	3%	5,232	2%	734	2%
Total households	30,454	100%	217,256	100%	29,726	100%

Sources: U.S. Census Bureau, American Community Survey 2006-2010

Both Rio Rancho and the Volcano Heights study area show a relatively high percentage (12 and 16% respectively) of structures built since 2005. (See **Table A.4.**) In both areas, the largest percentage of structures were built in the 1990s. In the City of Albuquerque, the highest percentage (20%) of housing units were built in the 1970s.

4. Income and Education

There are just over 30,000 households in Volcano Heights, similar to the City of Rio Rancho. (See **Table A.5** and **Exhibit A.16.**) Average household size is 2.4 in both Volcano heights and Rio Rancho and slightly higher in the City of Albuquerque at 2.7. (See **Table A.2.**)

In all three areas, the highest percentage have incomes between the range of \$50,000-70,000. The City of Albuquerque has a higher portion of households at the lower range of incomes, with 25% earning less than \$25,000 per year. Volcano Heights study area has the lowest percentage at the lower income range, with only 11% earning less than \$25,000, and the highest percentage of the highest income range, with 25% earning more than \$100,000 per year.

The vast majority of the population over age 25 in all three areas has a high school diploma or equivalent, with only 5.2% in Volcano Heights without a diploma, compared to 6.6% in Rio Rancho and 13% in Albuquerque. (See **Exhibit A.17.**) Almost half of those over age 25 in Volcano Heights study area have an associates degree or higher (46%), compared to 38% in Albuquerque and 38% in Rio Rancho.

Appendix A. Pre-existing Conditions

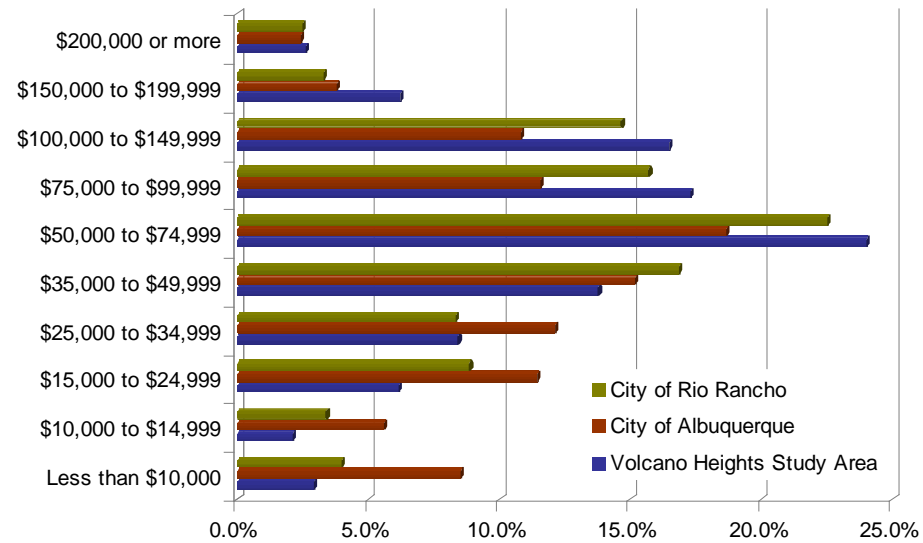

Sources: U.S. Census Bureau, American Community Survey 2006-2010, MRCOG

Exhibit A.16 – Household Income, 2010

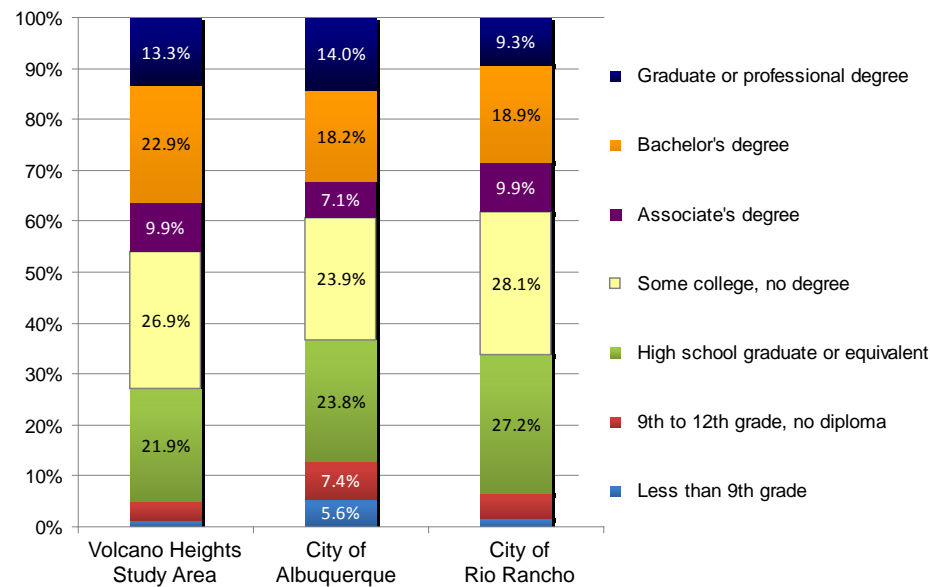

Sources: U.S. Census Bureau, American Community Survey 2006-2010, MRCOG

Exhibit A.17 – Education Level of Population Age 25+, 2010

Appendix A. Pre-existing Conditions

C. Economic Development

1. Major Activity Centers

The land within Volcano Heights is undeveloped, but the area has been recommended to be designated as a Major Activity Center by the Volcano Mesa amendment to the Rank II West Side Strategic Plan. A Major Activity Center would provide an opportunity to address the imbalance of jobs east of the river and predominantly housing on west of the river by serving the region with employment, commercial, service, and retail opportunities. The Comprehensive Plan's Centers and Corridor Plan would need to be updated to finalize the designation. It is unknown at this time when that final step will be taken.

Major Activity Centers (MACs) are meant to focus area employment and commercial and retail opportunities in particular locations well-served by existing transportation systems. Per the Comprehensive Plan, Major Activity Centers must be located on large tracts of undeveloped land (300 acres or more) and must be located at the intersection of two major roadways. Opportunities for designation of a Major Activity Center on the West Side other than Volcano Heights are limited due to a lack of undeveloped land near two critical roadways. The Volcano Heights area provides a critical opportunity for the West Side to locate a mix of employment, commercial, service and residential uses to meet the needs of the wider area and decrease cross-river traffic.

The Albuquerque-Bernalillo County Comprehensive Plan designates two areas on the West Side of Albuquerque as Major Activity Centers (MAC): the Cottonwood Center and the Atrisco Business Park. (See **Exhibit A.18.**) These areas have developed in a low-density, auto-oriented, and single-use pattern.

Four areas on the West Side are designated as Proposed Major Activity Centers; however, these are all west of Paseo del Volcan.

The east side of Albuquerque contains ten designated Major Activity Centers. According to MRCOG, in 2008, there were 152,300 jobs provided on the east side of Albuquerque in the top seven activity centers on the east side, including Downtown, Uptown, UNM/CNM/Hospitals, Jefferson/I-25, Midtown, Sunport, and Kirtland Air Force Base. This is in stark contrast to the 14,400 jobs available in 2008 on the west side in the Intel/Cottonwood and Atrisco Business Park centers.

This suggests that the majority of people who live on the west side find their employment on the east side of the river, and, as an auto-oriented city, this has led to significant traffic problems today, which are predicted to continue and worsen over time. According to MRCOG, based on present-day land-use and zoning policies, the current trend of employment growth concentrated on the east side of the Rio Grande will continue and will far outpace employment growth on Albuquerque's West Side. The only way to reverse this trend is to provide significant and attractive opportunities for employers to locate on the West Side.

A comparison of several comparable MACs is shown in **Table A.6.** Commuting patterns are shown for Uptown MAC, Cottonwood MAC, and Journal Center MAC in **Exhibits A.25-27.**

Appendix A. Pre-existing Conditions

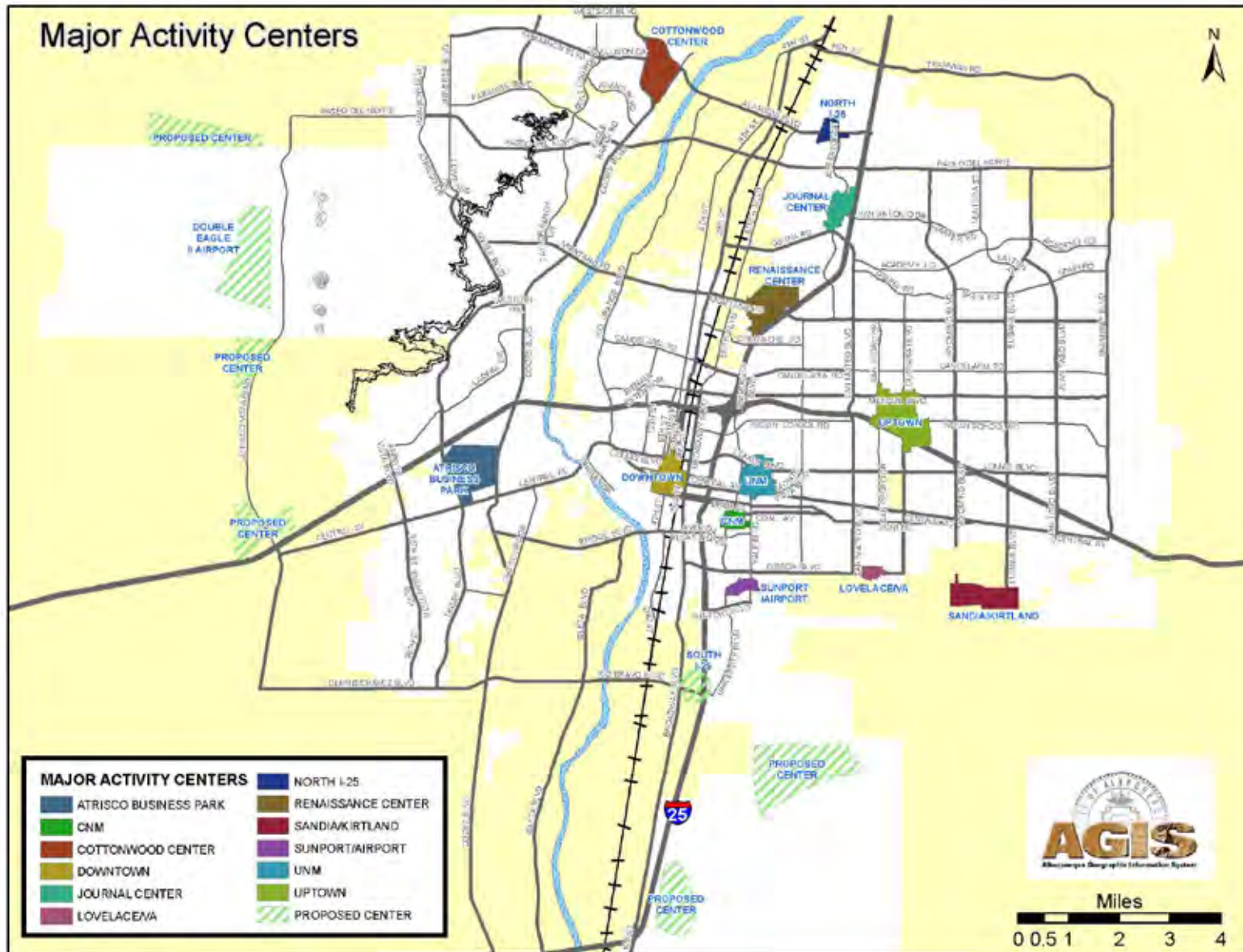

Exhibit A.18 – Major Activity Centers in Albuquerque, 2012

APPENDIX

Appendix A. Pre-existing Conditions

TABLE A.6 – MAJOR ACTIVITY CENTER COMPARISON

	Uptown	Atrisco	Renaissance Center	Cottonwood Center	UNM	Downtown	Journal Center	CNM	North I-25	Sunport	Lovlace VA
OVERVIEW											
Acres	593	547	411	366	315	282	201	128	122	96	73
Driving distance to nearest interstate	0.0 miles	0.4 miles	0.0 miles	4.1 miles	0.6 miles	0.4 miles	0.0 miles	0.6 miles	0.3 miles	0.6 miles	2.8 miles
EMPLOYMENT											
Estimated jobs (2008)	28,703	2,020	4,858	3,657	10,194	16,342	3,166	407	1,415	136	805
Commuting workers	28,567	1,990	4,858	3,657	10,174	16,251	3,166	406	1,415	136	803
Jobs/acre	48	4	12	10	32	58	16	3	12	1	11
Office sq. ft. (2011)	1.82 million	N/A	320,000	~0	900,000	2.74 million	2.80 million	N/A	N/A	1.25 million	N/A
Retail sq. ft. (2010)	1.95 million	~0	630,000	4.07 million	1.0 million	550,000	~0	N/A	N/A	N/A	N/A
Total sq. ft.	3.77 million	N/A	950,000	~4.07 million	1.9 million	3.29 million	~2.80 million	N/A	N/A	N/A	N/A
COMMUTE LENGTH (2009)											
Less than 10 miles	76%	56%	68%	57%	78%	77%	70%	76%	68%	65%	72%
10 to 24 miles	15%	30%	11%	16%	13%	13%	11%	15%	12%	22%	20%
25 to 50 miles	2%	3%	6%	10%	3%	2%	6%	2%	7%	4%	2%
Over 50 miles	7%	12%	15%	17%	7%	7%	13%	7%	14%	9%	6%
TRAFFIC COUNTS (2010)											
High	30,600	34,250	35,850	45,400	26,900	23,700	62,250	21,250	30,750	11,650	20,700
Low	11,600	19,650	8,650	18,800	9,500	5,150	21,733	10,850	7,100	9,800	13,000
High Street	Louisiana	Coors	Montaño	Coors Bypass	Central	Lomas	Paseo del Norte	Avenida Cesar Chavez	Alameda	Yale	Gibson
Low Street	Indian School	Central	Renaissance	Coors	Girard	Third	Jefferson	Coal	Jefferson	Randolph	San Mateo

Sources: AGIS; MRCOG; Grubb & Ellis Market Trends report, 1st quarter 2011 (Office); Grubb & Ellis Market Trends report, 4th quarter 2010 (Retail); MTP 2035 Roadway Functional Classification Map

Appendix A. Pre-existing Conditions

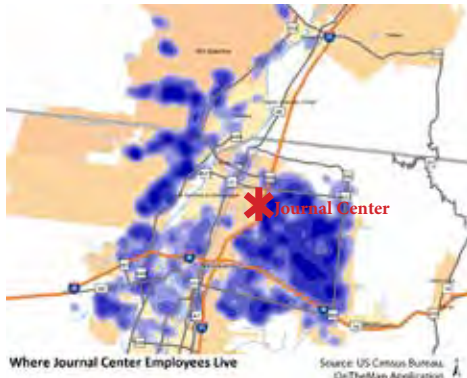
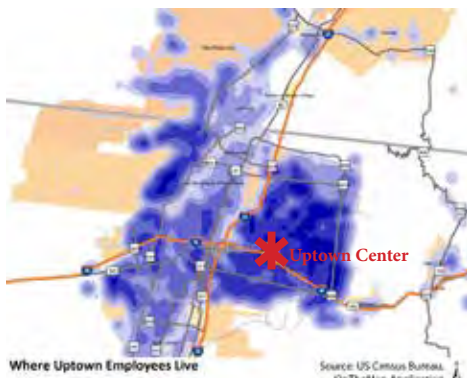

Exhibit s A.19-21 – Journal Center: Commuting Pattern, Traffic Counts, and Photo 2010



Exhibit s A.22-24 – Cottonwood Center: Commuting Pattern, Traffic Counts, and Photo 2010



Exhibits A.25-27 – Uptown Center: Commuting Pattern, Traffic Counts, and Photo 2010

APPENDIX

Appendix A. Pre-existing Conditions

TABLE A.7 – EMPLOYMENT IN VOLCANO HEIGHTS STUDY AREA, 2008

Industry	Employment Estimate	Percent
Retail Trade	6,022	32%
Eating and Drinking	3,364	18%
Educational Services	2,227	12%
Health Care & Social Assistance	1,586	9%
Other Services	1,364	7%
Professional, Scientific, Technical	676	4%
Construction	612	3%
Finance & Insurance	539	3%
Real Estate, Rental & Leasing	459	2%
Admin, Support, Waste Management, Remediation	297	2%
Government	283	2%
Arts, Entertainment & Recreation	259	1%
Information	197	1%
Manufacturing	195	1%
Wholesale Trade	185	1%
Unknown and Other	141	1%
Transportation and Warehousing	76	0%
Accommodation & Food Services <i>(except eating and drinking)</i>	24	0%
Agriculture, Forestry, Fishing	11	0%
Utilities	8	0%
Management of Companies	6	0%
Mining	2	0%
Total Employment	18,533	100%

Sources: Infogroup Dataset, National Industrial Classification, and MRCOG

2. Jobs and Employment

There are approximately 18,500 jobs within the Volcano Heights study area, primarily retail, including eating and drinking. (See **Table A.7.**) Educational sector and health sector jobs are the next highest percentage of jobs, with 12% and 9% respectively. A map of job sites in the study area, including employers with over 100 employees, is shown in **Exhibit A.28.** Professional jobs represent only 4% of jobs in the study area, and manufacturing represents only 2% of jobs. Both would be potential targets for new employers within Volcano Heights in the future.

Appendix A. Pre-existing Conditions

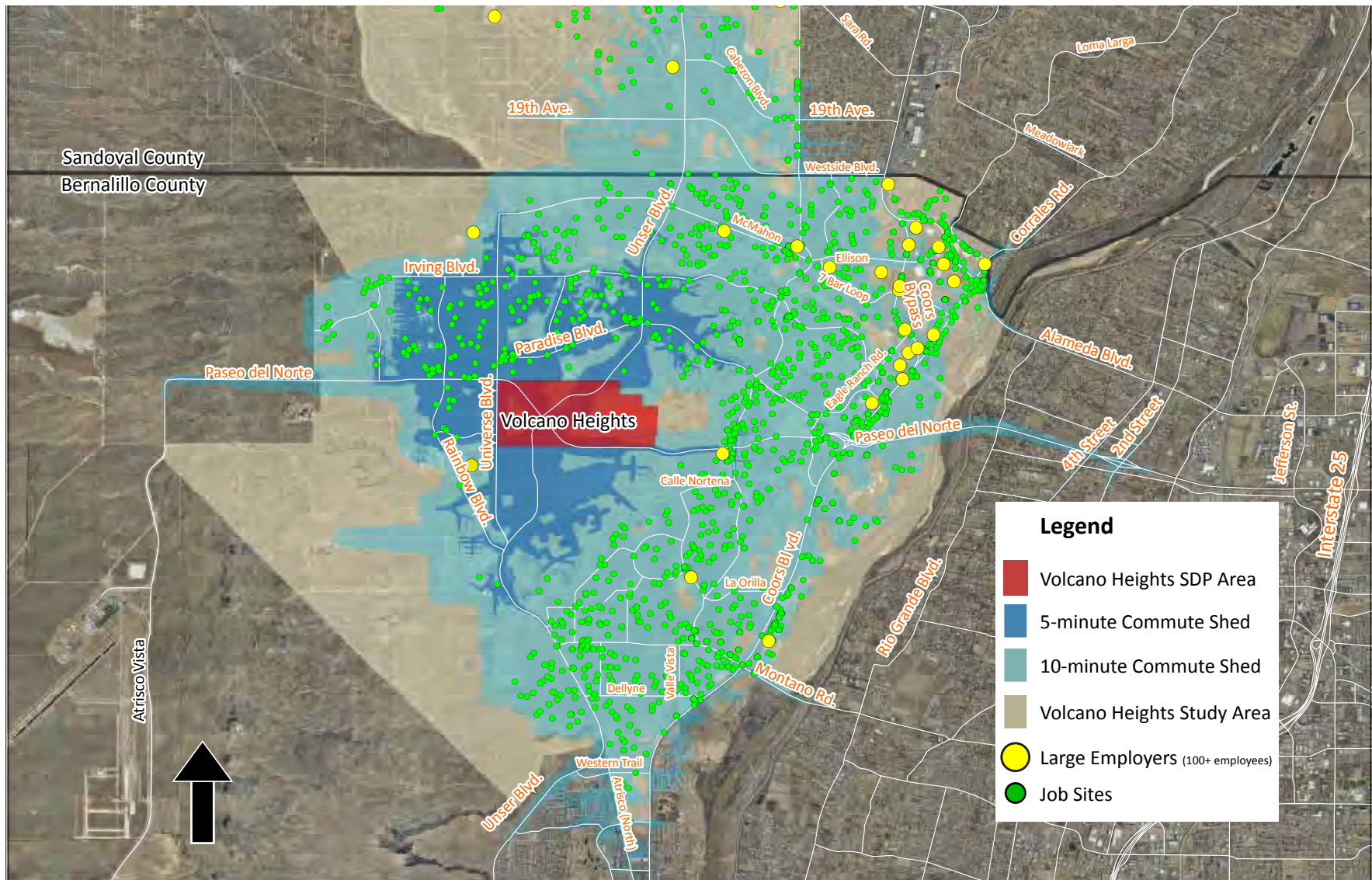

Source: AGIS and MRCOG

Exhibit A.28 – Employment Locations, 2010: Volcano Heights Study Area

Appendix A. Pre-existing Conditions

D. Transportation

In its 2035 Metropolitan Transportation Plan, MRCOG forecast that the four county Mid-Region Metropolitan Planning Organization (MRMPO) area (Bernalillo, Sandoval, Valencia and Tarrant counties) would grow by 668,000 people, 310,000 new homes, and 210,000 new jobs. Development West of the Rio Grande is expected to capture almost half the new growth, but only 20% of new jobs. If the area continues to develop with its current land-use pattern of generally low density, auto-oriented growth on the fringe of the urbanized area, the growing gap between homes and jobs will increase congestion on the region's transportation corridors and, particularly, the region's river crossings.

1. Regional Roads

MRCOG is the designated Metropolitan Planning Organization (MPO) for the Albuquerque Metropolitan Planning Area (AMPA). MRCOG convenes meetings for decision-makers from jurisdictions within the AMPA to come together to plan for transportation and other decisions affecting the region.

Relevant Documents:

- Future Albuquerque Area Bikeways and Streets (FAABS) [To be updated and renamed Long Range Transportation System]
- Metropolitan Roadway Access Policies for the Albuquerque Metropolitan Planning Area (AMPA) [2010 Appendix to FAABS]
- Long-range Roadway System Map (2004)
- 2035 Metropolitan Transportation Plan (5-year plan)

Relevant Agencies, Boards, & Committees:

- Mid-region Council of Governments (MRCOG)
- New Mexico Department of Transportation (NMDOT)
- City of Albuquerque Department of Municipal Development (DMD)
- Metropolitan Transportation Board (MTB)
- Transportation Coordinating Committee (TCC)

The Metropolitan Transportation Board (MTB) is made up of elected officials from the jurisdictions within the AMPA and sets policy for transportation issues in the urban area. The MTB coordinates local government transportation planning and project development, identifies federal funding for transportation projects, including roadway widenings and extensions, sets policy for roadway access, identifies corridors and alignments for new roadways, identifies bicycle facilities and federal funding for them, and makes decisions about long-range issues such as Bus Rapid Transit proposals.

Limited Access Roadways are identified and the Access Control Policies are stated in the Future Albuquerque Area Bikeways and Streets (FAABS) in Appendix D – III, Access Limitations. The components of the FAABS, including the Limited Access Roadways and the Access Control Policies, are integrated into the 2035 Metropolitan Transportation Plan (MTP) and all future MTP updates. All of these documents are being revised as of 2013.

Appendix A. Pre-existing Conditions

a. Road Classification

As of 2012, the functional classifications for Paseo del Norte and Unser Boulevard are Urban Principal Arterials on the Long Range Roadway System Map. MRCOG will be adding Primary Streets as shown in **Exhibit 10.1 on page 167** to the Long Range Roadway System Map during its next update.

Paseo del Norte and Unser Boulevard are identified in FAABS as limited-access roadways. The TCC approved additional access points in Volcano Mesa to support development in Volcano Cliffs and Volcano Heights. [See TCC Resolution 2013-03 in **Appendix C.**]

These and existing access points are shown in **Exhibit 10.3 on page 171**. Access to the Plan areas is to be provided via Primary Streets connected to these access points, and access to individual developments is to be provided via Secondary Streets.

b. Ownership and Construction

In this area, the City owns, controls, and is responsible for the planning and maintenance of both Paseo del Norte and Unser Boulevard. Paseo del Norte is a state facility east of Eagle Ranch Road. A 1989 working agreement between the City and State states that once Paseo del Norte is constructed to four (4) lanes, it will revert to a State facility to Universe Boulevard.

The City's Department of Municipal Development (DMD) developed plans in 2007 for the extension of Paseo del Norte, the cross sections for which show the two-lane construction as of 2011 and the future construction configurations of six (6) lanes with separate or shared bus rapid transit lanes. Future construction will be the responsibility of private developers as abutting land is developed.

As of 2013, the City has constructed Unser to 2 lanes with 36-foot median between Boca Negra Dam and Paradise Boulevard. Small portions north of Volcano Heights were constructed privately in conjunction with abutting development. The road widens and median narrows to provide turn lanes near major intersections. The city-owned 156-foot right-of-way from Boca Negra Dam to Paseo del Norte will allow the expansion of Unser to four (4) lanes in the future.

Assessments paid by Volcano Cliffs property owners for Special Assessment District (SAD) 228 will pay for the construction of the full cross section of the first third (1/3) of Unser north of Boca Negra Dam. A new SAD (229) is proposed for the area north of SAD 228, where Unser would straddle the boundary between Volcano Cliffs and Volcano Heights, to pay for the build out of Unser to Paseo del Norte.

The City completed construction in 2011 on roadway segments and intersections connecting Unser to Rainbow and Universe Boulevard on the southern edge of the Volcano Cliffs SDP and recently constructed a temporary road connecting Unser north of Paseo del Norte to the northern boundary of Heights. A segment of Unser north of the Plan area was constructed as Sundance Estates developed, and a new segment of Unser north of will be constructed as a new subdivision, Boulders, develops.

APPENDIX

Appendix A. Pre-existing Conditions

c. Right-of-Way (ROW)

As of 2011, right-of-way (ROW) on Paseo del Norte varies between 50-200 feet. Through the Escarpment, ROW is around 200 feet and quickly narrows to a temporary cross section at the top of the Escarpment to the existing Avenida de Jaimito, where ROW is only 50 feet. ROW is 50 feet for about 3,000 feet west along the Town of Alameda Grant line. Paseo del Norte then heads north and west within a 70-foot ROW (to be widened to 156 feet as abutting property owners dedicate land and construct the road to 4 lanes) all the way to Universe. From Universe Boulevard to Rainbow Boulevard, the City owns 156 feet of ROW.

The City owns 156 feet of ROW for Unser Boulevard between the Escarpment to Paseo del Norte. As of 2011, the City has obtained right-of-entry and is in the process of acquiring ownership of the center 78 feet of the ultimate 156-foot ROW north of Paseo del Norte to Paradise Boulevard. The remaining 78 feet of ROW will require dedication as land on either side of the road develops (i.e. 39 feet per side). Some blading and permanent fill has taken place as easements allow.

d. Intelligent Transportation Systems (ITS)

Intelligent Transportation Systems (ITS) involves strategic placement of advanced sensors and dynamic message boards located on the roadside but operated remotely from a management center, combined with advanced communications among operators of the transportation system to monitor and manage congestion on the road network. ITS can help maximize the efficiency of roadways to meet the demands placed upon them by a growing population. Advanced technology allows ITS staff to monitor travel conditions in real time and alert drivers of travel congestion and/or hazards “downstream” so that they can avoid delays and unsafe conditions. Staff can also adjust signal timing to optimize traffic flow.

ITS in the AMPA is coordinated through the MRCOG’s ITS Subcommittee, comprised of federal, state, and local stakeholders. The ITS Subcommittee makes recommendations to the TCC to ensure that all ITS deployment is conducted in a coordinated manner and meets the federal requirement for consistency with the AMPA Regional ITS Architecture.

Appendix A. Pre-existing Conditions

Many corridors involve multiple jurisdictions, making it essential to fully coordinate the response to travel conditions and hazards. MRCOG has prioritized the planning and implementation of a Regional Transportation Management Center to co-locate stakeholder agencies, including the NMDOT, City of Albuquerque, Bernalillo County, and NM State Police, into a single building. By housing transportation operator staff from multiple agencies in the same facility, coordination will be significantly improved, allowing optimized traffic flow and coordinated incident response for increased safety for travelers across all jurisdictions. The project is currently in the outer years of the 2014-19 Transportation Improvement Program.

e. Population Projections

Discussions about accommodating anticipated growth in this region in terms of transportation planning and decision-making are based on projected growth for the region. The source for the county level population projections is the Bureau of Business and Economic Research at the University of New Mexico (BBER).

f. Traffic Counts

Traffic counts for 2011 from MRCOG show 9,900 daily trips on Paseo del Norte at Rainbow Boulevard, rising to 12,200 trips by Golf Course Road. Unser Boulevard shows 15,200 daily trips at the Escarpment to the south, but few trips farther north.

MRCOG traffic counts anticipated for 2035 use the regional traffic model based on County-level population projections and current land-use trends. Because the model assumes a continuation of current trends, not land-use changes such as those proposed by the Volcano Heights Plan, these traffic counts should be seen as baseline numbers, which would change as land develops and transportation patterns shift.

In the Volcano Heights area, Paseo del Norte generally shows daily volumes in the range of 25,000-30,000 trips per day in each direction. [See **Table A.8.**] Peak hour traffic in the morning ranges from 2,200-2,800 heading east and 1,000-1,700 trips heading west. Peak hour traffic in the evening ranges from 2,300-3,000 trips heading west and 1,800-2,300 trips heading east.

TABLE A.8 –TRAFFIC COUNTS, 2035

	Total Daily Trips	AM Peak Hour	PM Peak Hour
Paseo del Norte	50-60,000	2,200-2,800 East / 1,000-1,700 West	1,800-2,300 East / 2,300-3,000 West
Unser Boulevard	15,000 – 25,000	600-1,200 South / 600-1,000 North	800-1,200 South / 900-1,500 North

Source: MRCOG

APPENDIX

Appendix A. Pre-existing Conditions

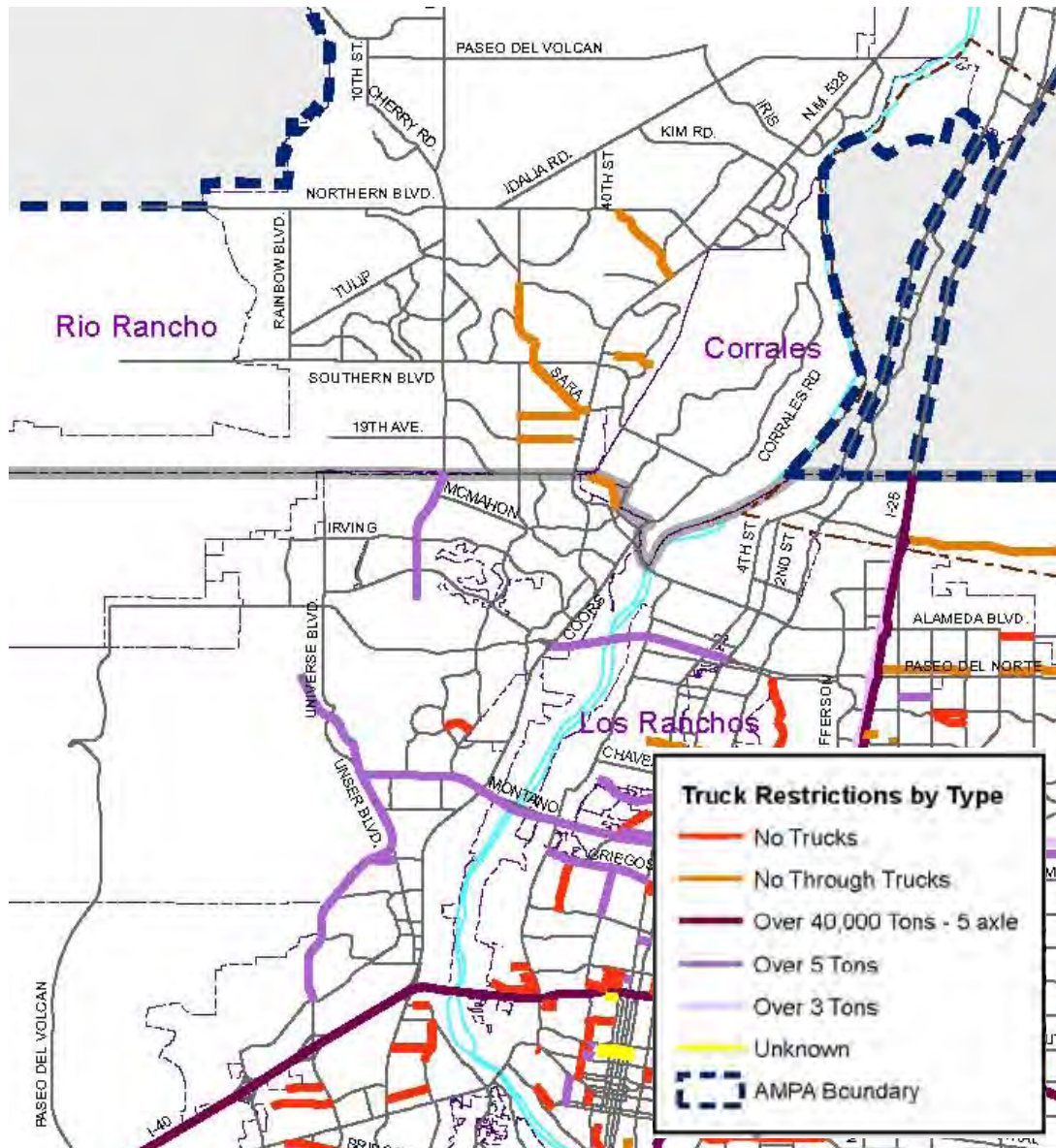

Exhibit A.29 – Truck Restrictions Map

In the same area, Unser Boulevard generally shows daily volumes in the range of 7,500-13,500 trips per day in each direction. Peak hour traffic in the morning ranges from 600-1,200 trips heading south and 600-1,000 heading north. Peak hour traffic in the evening ranges from 800-1,200 heading south and 900-1,500 heading north.

These numbers support the general perception that residents leave the area via Paseo del Norte in the morning to head east across the river and return home after work in the evenings. Traffic counts for Unser Boulevard seem to indicate that the roadway is used equally for travel north and south, with slightly higher traffic in the evenings than in the mornings, regardless of the direction of travel.

g. Truck Access

Truck restrictions are shown in **Exhibit A.29**. Truck traffic over 5 tons is prohibited on Paseo del Norte between 2nd Street and Coors Boulevard due to thin pavement and low bridges at 2nd Street and 4th Street.

Truck traffic over 5 tons is also prohibited on Unser Boulevard between Ladera Boulevard and the Escarpment, as well as north of Volcano Heights to the Albuquerque City Limits. [See **Section 13.3.9** starting on page 224.]

Trucks are expected to access Volcano Heights via either Paseo del Vulcan, which becomes Paseo del Norte just west of the Plan area, or Paseo del Norte west of Coors.

The preferred route for truck access to Volcano Heights is I-40 to Atrisco Vista, which turns into Paseo del Norte just west of the Heights boundary.

Appendix A. Pre-existing Conditions

TABLE A.9 – CONGESTION MANAGEMENT STRATEGIES

h. Congestion Management Process

MRCOG prioritizes strategies to reduce congestion through a Congestion Management Process (CMPs) for corridors ranked by congestion level. Paseo del Norte (Paseo del Norte) was ranked 9th most congested corridor in 2008 and 3rd in 2010. Unser Boulevard was ranked 17th in 2008 and 13th in 2010.

The strategies in **Table A.9** are described in the CMP Toolkit, available on the MRCOG website. (<http://www.mrcog-nm.gov>)

2. Local Roads

As of 2011, there are no local roads constructed in Volcano Heights. (See **Section 10.7 starting on page 187** for **Secondary Street** criteria and **Exhibit 10.1 on page 163** for Primary Street proposed by this Plan.)

There are very few opportunities to connect to local roads abutting the Plan area. These include Oakridge Street, Treeline Avenue, and Woodmont Avenue to the west, Urraca Street to the south, and Adina Lane to the north.

Congestion Management Strategies	PdN	Unser
Active Roadway Management		
Traffic signal timing and coordination	High	High
Traffic signal equipment modernization	High	High
Ramp meters	Medium	Low
Access management	High	High
Traveler information devices	High	High
Roadway signage improvements (wayfinding)	Medium	Medium
Communications networks and roadway surveillance coverage	High	High
Travel Demand Management/Alternative Travel Modes		
New fixed guideway transit travelways and dedicated transit lanes	High	High
Transit service expansion	High	High
Transit vehicle information	High	Medium
Transit intersection queue-jump lanes and signal priority	High	High
Electronic fare collection	Medium	Medium
Park & Ride facilities	High	High
Telework and flexible schedules	Medium	Medium
Ridesharing travel services	Medium	Medium
Alternative travel mode events and assistance	Medium	Medium
Off-street multi-use trails	High	High
On-street bicycle treatments	Low	High
Incident		
Incident management plans (regional and site-specific)	High	Low
Incident response and Courtesy Patrol	High	Low
Physical Roadway Capacity		
Intersection turn lanes	Medium	High
Deceleration lanes	Medium	Medium
Hill-climbing lanes	Low	Medium
Grade-separated railroad crossings	Medium	Low
HOV bypass lanes at ramp meters	Medium	Low
Roundabout intersections	Medium	Medium
New grade-separated intersections	High	Medium
New (or converted) HOV/HOT/Truck lanes	Medium	Low
New travel lanes (general purpose)	High	High
New roadways	Low	Medium

Source: MRCOG

APPENDIX

Appendix A. Pre-existing Conditions

3. Transit

As of 2013, MRCOG is conducting a feasibility study for a High-Capacity Transit Service corridor from Paseo del Norte to the Journal Center Major Activity Center near the Jefferson/I-25 intersection. Preferred alternatives for corridor alignments are expected by Summer 2013.

As of 2012, City RapidRide services the transit corridors and stops shown in **Exhibit A.30**. The Northwest Transit Center is approximately 5 miles from the Paseo del Norte / Unser Boulevard intersection.

4. Bike Paths / Trails

MRCOG's Bike and Trails Map designates bike facilities as either bike routes, bike lanes, or trails. Bike lanes are designated exclusively for bicycle travel, with bike lanes on the street separated from vehicle travel lanes with striping. (See **Exhibit A.32** for those in Volcano Mesa.) Bike lanes are typically found on arterial and collector streets, where higher traffic volumes and speeds warrant more separation for the safety of bicyclists. Bike routes are designed to accommodate autos and bikes in a shared travel lane.

According to the Albuquerque Bikeways and Trails Master Plan, May 2011, bike routes typically work best on streets with speed limits of 25 miles per hour or less and traffic volumes of 3,000 average daily trips or less. Trails are separated from travel lanes and are exclusively for use by pedestrians, bicyclists, and sometimes equestrians. Where these trails cross roadways, intersections can either be at-grade or grade separated.

Unser Boulevard and Paseo del Norte incorporate both on-street bike lanes and an off-street, multi-use trail. See cross sections in **Exhibit 10.16 on page 184** and **Exhibit 10.17 on page 185**, respectively.

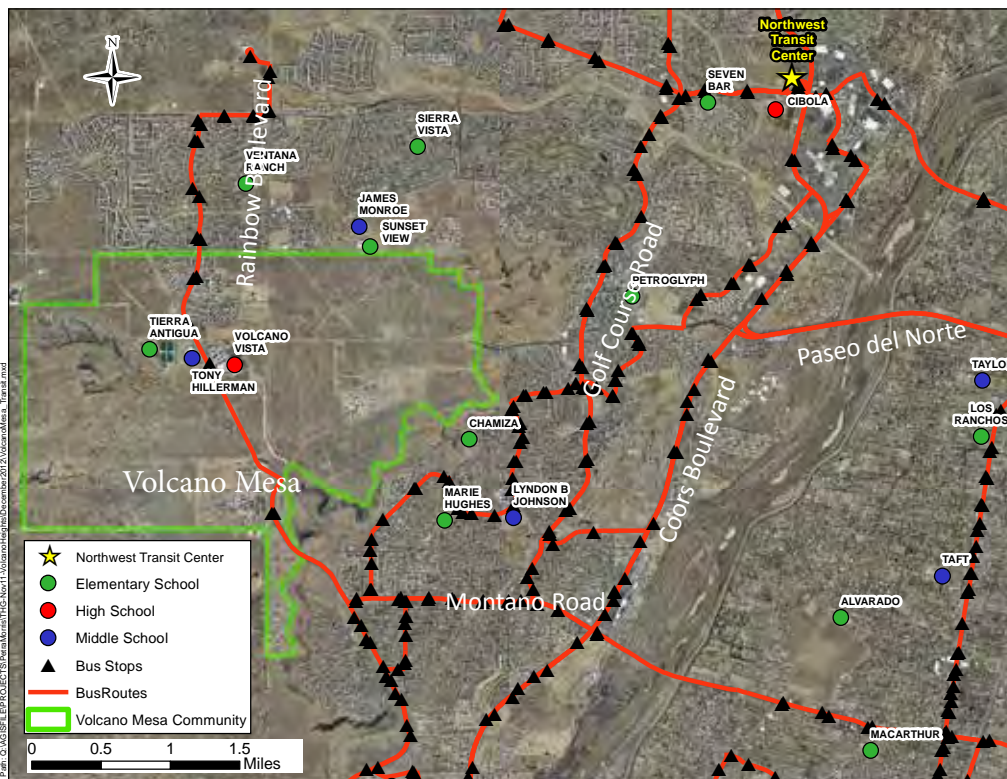

Exhibit A.30 – Pre-existing Transit Routes and Schools near Volcano Mesa

Appendix A. Pre-existing Conditions

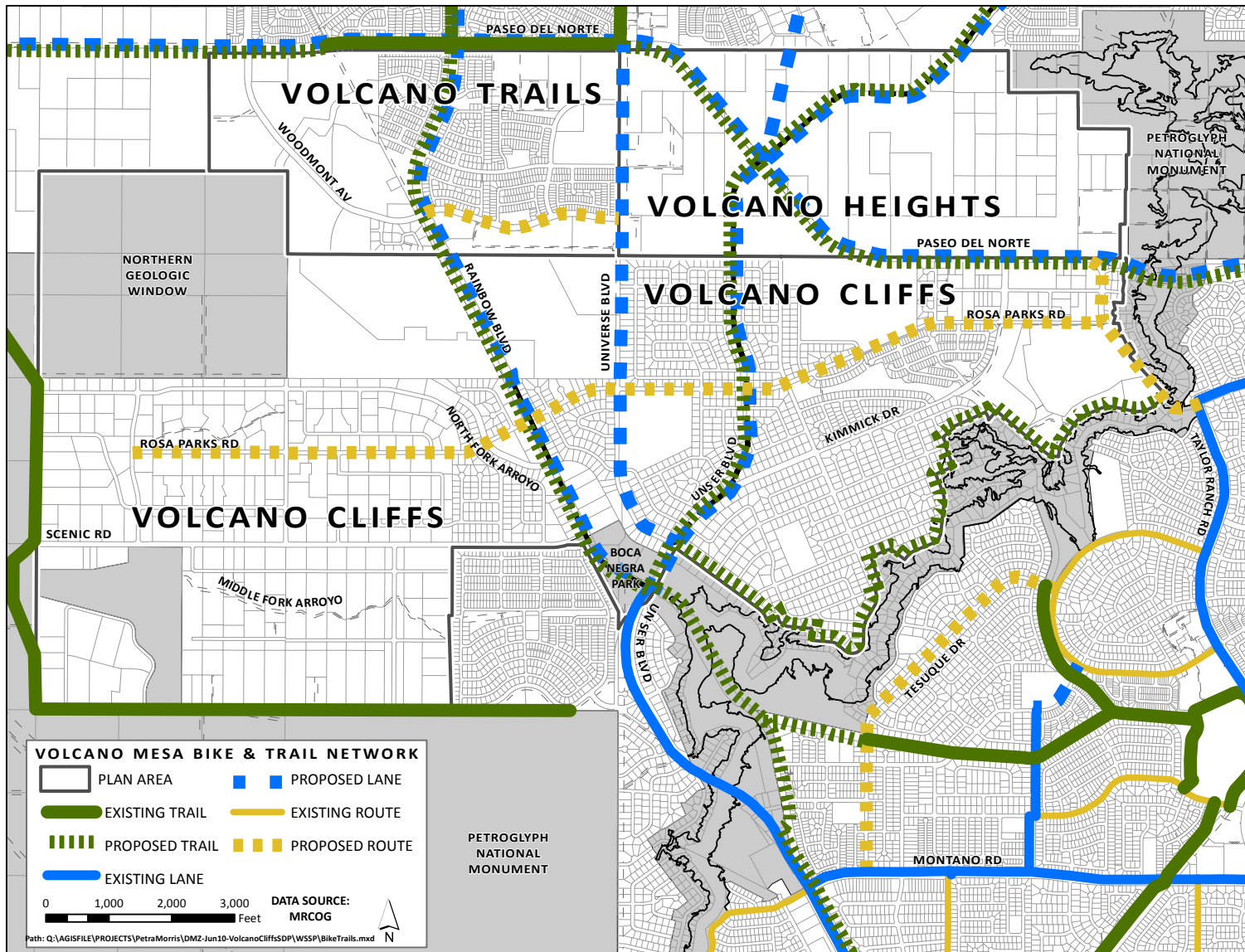

Exhibit A.32 – Volcano Mesa Bike and Trail Network Map

APPENDIX

Appendix A. Pre-existing Conditions

Mayor Berry's "Albuquerque: The Plan" proposes to construct links to connect existing bicycle trails that would create a 50-mile bike loop around Albuquerque, a portion of which would link Paseo del Norte to existing bike trails on the East Side. See **Exhibit A.31.**

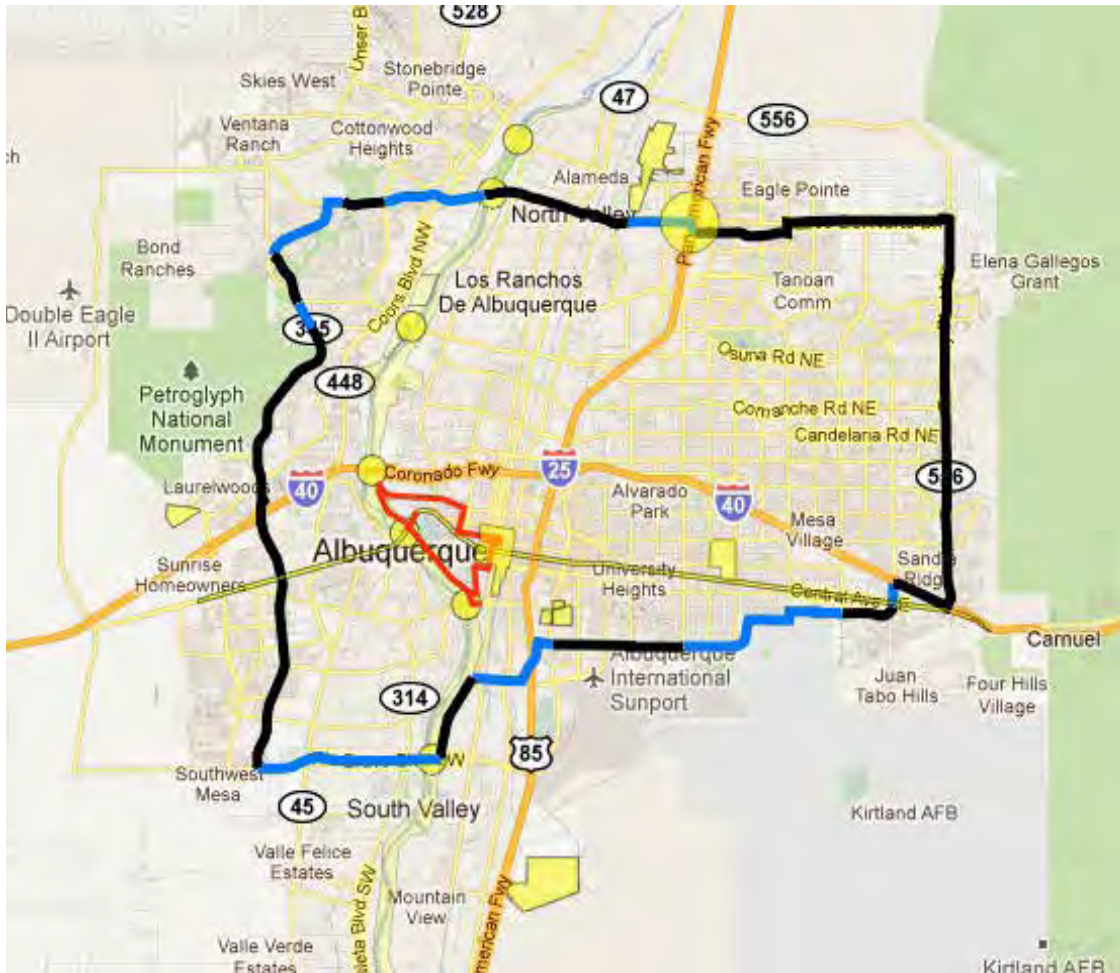

Exhibit A.31 –Mayor Berry's Proposed 50-mile Bike Loop

MRCOG's Long Range Bikeways Plan indicates a proposed bike route from Taylor Ranch Road south and west of the Plan area to Paseo del Norte, where it meets with an existing pedestrian bridge over Paseo del Norte providing access to the Petroglyph National Monument. This route offers an opportunity to extend the bike route north along the Park Edge Road and/or along a multi-use trail from the pedestrian bridge north within the Petroglyph National Monument boundary.

MRCOG's Long Range Bikeways Plan also shows a proposed bicycle route from Universe Boulevard west to Rainbow Boulevard along Woodmont Avenue within Volcano Trails. The Primary Street network for Heights extends Woodmont Avenue into Volcano Heights. A bicycle route along this corridor would link to the eventual bike lanes and multi-use trails on Unser Boulevard and Paseo del Norte, as well as continuing east to connect to the Park Edge Road and potential north/south multi-use trail on the Monument edge.

Finally, on the north boundary of the Plan area, MRCOG's Long Range Bikeways Plan shows a proposed bike lane extending north from the Unser Boulevard / Paseo del Norte intersection toward Paradise Boulevard. Because the configuration of the subdivision and roads north of the Plan boundary, the best opportunity for connection with minimal impact to existing residents might be across a property owned by the Ventana Ranch Community Association to the existing Adina Lane, which leads to Vivaldi Trail that connects to Paradise Boulevard.

Appendix A. Pre-existing Conditions

5. Commuting Patterns

Commuters within the Volcano Heights study area spent on average between 20 and 30 minutes traveling to work. (See **Table A.10.**) Albuquerque commuters had an average travel time of 20 minutes, while Rio Rancho commuters traveled an average of 30 minutes.

In all three areas, most people travel to work by car. (See **Table A.11** and **Exhibits A.33-35.**) All three areas had just over 10% of people who carpool, with Rio Rancho the highest percentage by a slight margin at 11.6%. The City of Albuquerque had the highest portion of walkers and transit takers. Volcano Heights study area and Rio Rancho were similar on both counts. Again by a slight margin, Rio Rancho had the highest percentage of people working from home, followed by Volcano Heights study area.

TABLE A.10 – AVERAGE TRAVEL TIME TO WORK, 2010

Geography	Estimate (minutes)
Census Tract 47.16	25
Census Tract 47.17	25
Census Tract 47.20	27
Census Tract 47.22	22
Census Tract 47.23	23
Census Tract 47.24	24
Census Tract 47.25	26
Census Tract 47.26	22
Census Tract 47.27	27
Census Tract 47.28	22
Census Tract 47.45	27
Census Tract 47.46	27
Census Tract 47.47	28
Census Tract 47.48	31
Census Tract 47.51	27
Census Tract 47.52	20
Census Tract 47.53	25
Census Tract 107.20	28
City of Albuquerque	21
City of Rio Rancho	29

Sources: U.S. Census Bureau, American Community Survey 2006-2010, MRCOG

APPENDIX

Appendix A. Pre-existing Conditions

TABLE A.11 - COMMUTING MODE, 2010

Mode of Transportation	Volcano Heights Study Area		City of Albuquerque		City of Rio Rancho	
	Number	Percent	Number	Percent	Number	Percent
Drove Alone (car, truck, or van)	34,197	82%	202,221	78%	30,251	80%
Carpool (car, truck, or van)	4,559	11%	28,576	11%	4,389	12%
Public Transportation (including taxicab)	361	1%	5,389	2%	346	1%
Walked and Other Means	1,013	2%	11,574	4%	957	3%
Worked at Home	1,664	4%	10,040	4%	1,732	5%
Total Workers 16 Years and Over	41,794	100%	257,800	100%	37,675	100%

Sources: U.S. Census Bureau, American Community Survey 2006-2010, MRCOG

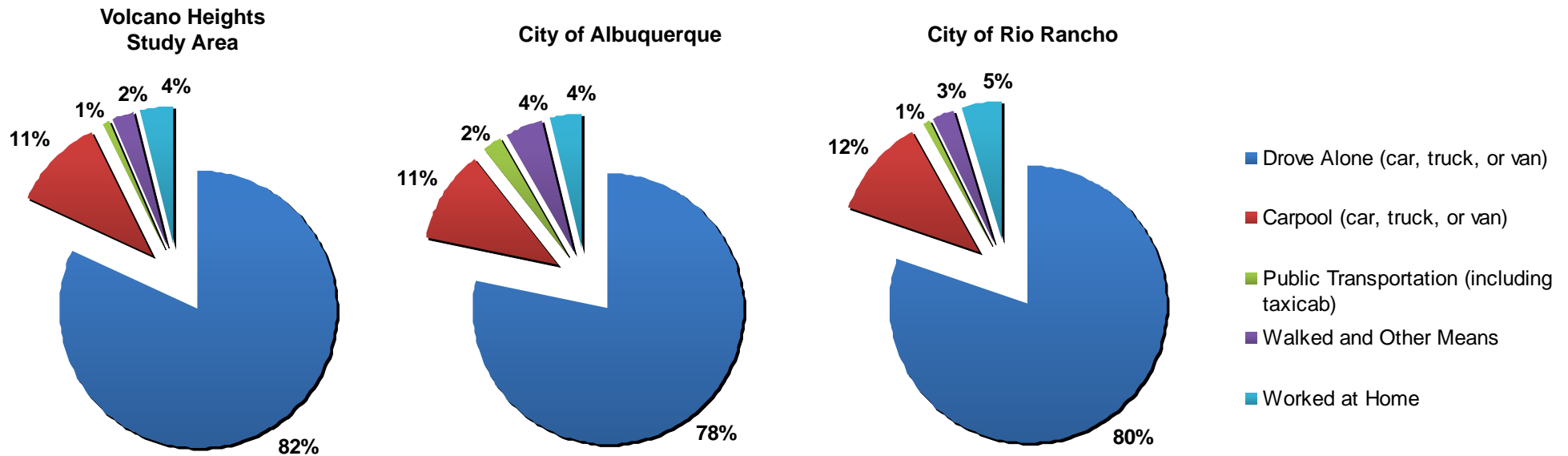

Sources: U.S. Census Bureau, American Community Survey 2006-2010, MRCOG

Exhibits A.33-35 – Commuting Modes, 2010: Volcano Heights Study Area, City of Albuquerque, and City of Rio Rancho

Appendix A. Pre-existing Conditions

E. Land Use and Urban Design

1. Pre-Existing Zoning

Land within Volcano Heights is designated by the Comprehensive Plan as Developing Urban. Prior to this Plan, the Volcano Heights Plan area was zoned primarily R-D, a zone category typically applied to newly annexed, developing areas of Albuquerque and meant as a kind of holding zone until a Sector Development Plan can be completed to provide more detailed guidance. The R-D zone, in conjunction with an approved Sector Development Plan, allows single-family dwellings, multiple family dwelling, mobile homes, and incidental commercial development to service the area based on a suburban model of development. Commercial uses are limited to 15% of the total development. See **Exhibit A.36**.

Zoning north of the Plan area includes SU-1 for C-1 with limited uses at the northeast corner of Paseo del Norte and Universe Boulevard. (See **Exhibit A.37**.) Between that zoning and the APS property with James Monroe Middle School and Sunset Elementary, there are three tracts of land with different zones. From west to east, these include:

- R-2 on the west with lots just over 1/10 acre (an average of .12 acre),
- SU-1 for Planned Residential Development (PRD) with floor-area ratio (FAR) of .5 and lots sized like R-2, and
- R-LT to the east, although the 1-acre lots have been subdivided in a way more typical of large-lot, single-family zones.

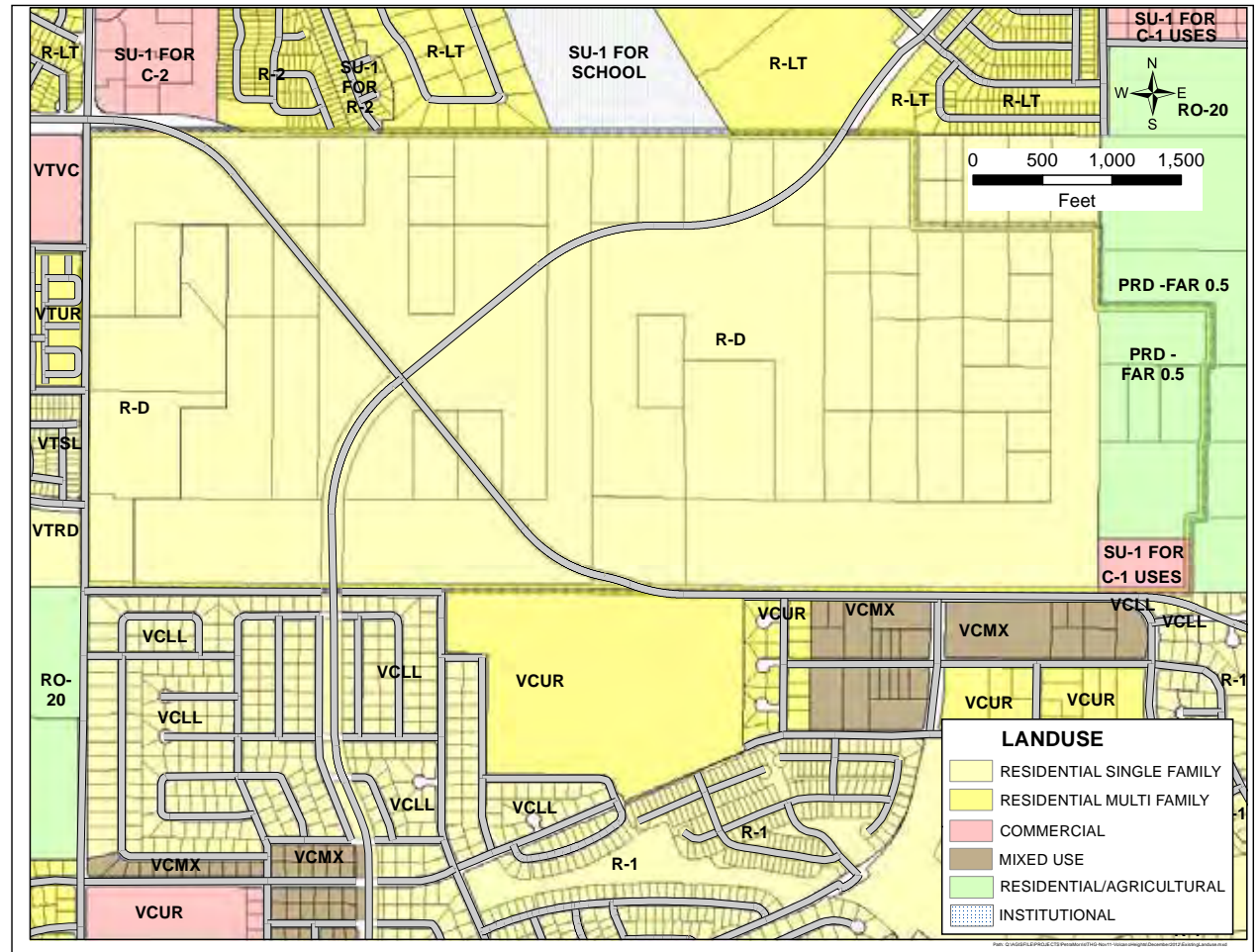

Exhibit A.36 – Pre-existing Zoning and Land Use

Appendix A. Pre-existing Conditions

East of the schools, one large tract of land is zoned R-LT. East of Unser Boulevard, the first tract of land is zoned R-LT. East of Lyon, land is zoned SU-1 for C-1.

West of the Plan area, zoning is R-LT on the northwest corner of Universe Boulevard and Paseo del Norte. The southwest corner is zoned SU-2 Volcano Trails Village Center (VTVC). Moving south, the remaining zones abutting the Volcano Heights Plan boundary are residential:

- a medium-density SU-2 Volcano Trails Urban Residential (VTUR),
- a slightly lower-density SU-2 Volcano Trails Small Lot (VTSL), and
- a low-density SU-2 Volcano Trails Residential Developing (VTRD) zone.

South of the Plan area, zoning is predominantly residential, with one mixed-use zone (SU-2 Volcano Cliffs Mixed Use - VCMX) south of Paseo del Norte near Kimmick Drive. The residential zones from west to east include the following:

- SU-2 Volcano Cliffs Large Lot (VCLL) with average lot size of 1/4 acre (.25).
- SU-2 Volcano Cliffs Urban Residential (VCUR), which is a large tract of land being master-planned as La Cuentista II, and
- SU-2 Volcano Cliffs Large Lot (VCLL) on the eastern edge of the Volcano Cliffs Plan area.

2. Pre-Existing Land Use

In general, the West Side remains predominantly single-family subdivisions served by few major arterials, leading to almost exclusive vehicle travel and congestion at peak hours. In the last 10 years, more commercial and retail has filled in along corridors, particularly at major intersections. The development pattern, limited river crossings, and imbalance of jobs on the east side of the river and housing on the West Side concentrates traffic onto few arterials. The Major Activity Center proposed for Volcano Heights is intended to provide the opportunity for major employment on the West Side to counteract the commuting pattern, mitigate congestion at peak hours, and diversify land uses on the West Side.

Land use surrounding Volcano Heights is largely residential. (See **Exhibit A.36**). The Petroglyph National Monument provides an open space and culturally rich amenity. The northeast and southwest corner of Universe Boulevard and Paseo del Norte are reserved for commercial development. Land farther north of the Plan area near Paradise and Unser Boulevards is also reserved for commercial development.

Volcano Trails and Volcano Cliffs Sector Development Plans changed zoning to encourage higher-density residential development near mixed-use and Village Center areas for neighborhood-serving commercial and retail services. This movement toward mixed use development offers support and additional opportunities for higher-density residential and more intense non-residential activity in Volcano Heights, which can support regional retail and office uses in addition to neighborhood-serving commercial land uses.

Appendix A. Pre-existing Conditions

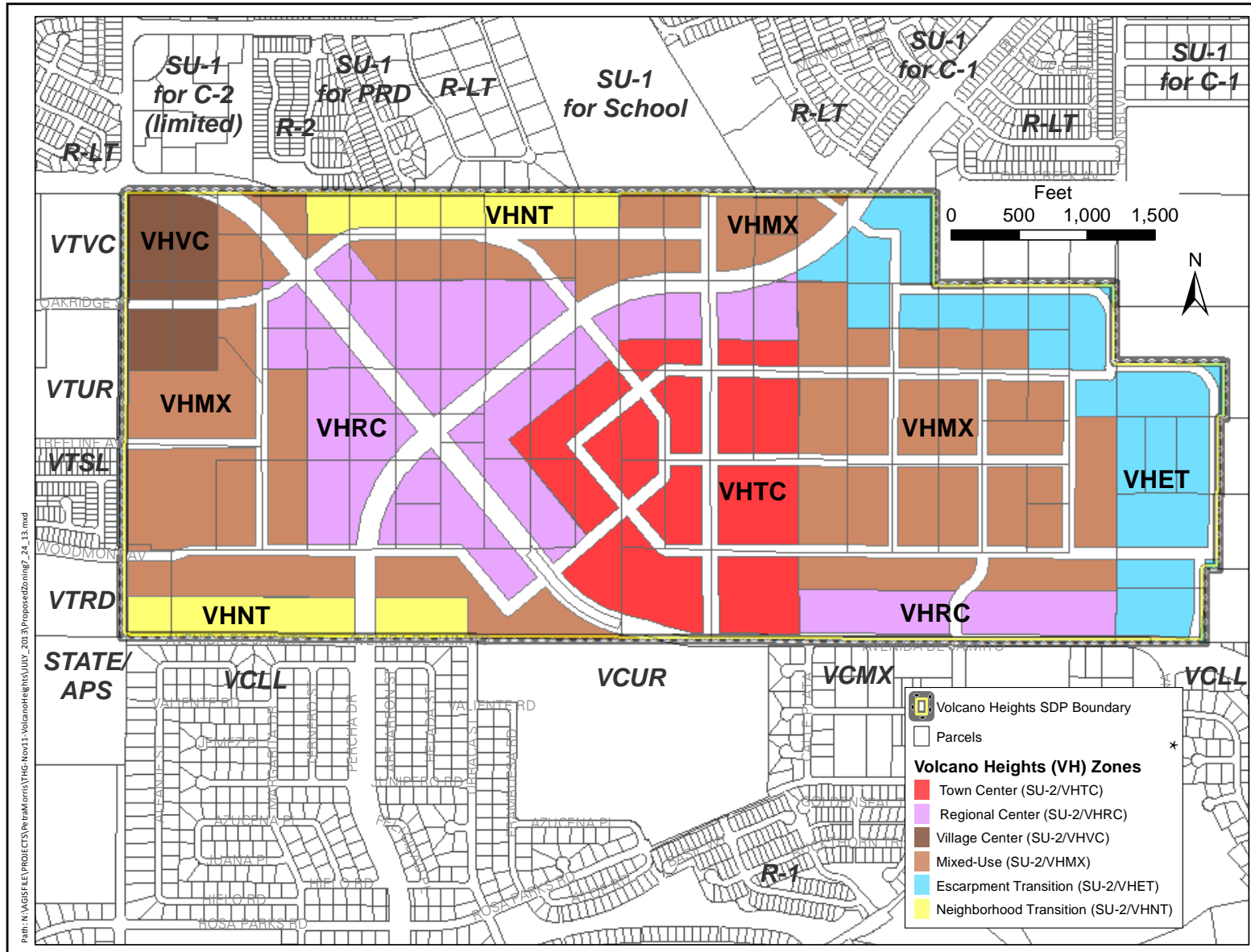

Path: N:\AGIS\FILE\PROJECTS\PetraMorris\THG-Nov11-VolcanoHeights\JULY_2013\ProposedZoningZ_24_13.mxd

* All Volcano Heights Zones are Special Neighborhood (SU-2) Zones Exhibit A.37 – Existing Zoning Surrounding the Plan Area and New Zones in Volcano Heights

APPENDIX

Appendix A. Pre-existing Conditions

3. Property Ownership

As of 2012, there are just over 30 property owners within the Plan area, which is made up of 99 unplatted properties predominantly 5 acres in size (very few are 2.5 acres, none less than 2 acres, and very few 10+ acres). See **Exhibit A.39**.

Six property owners own approximately 20 or more acres, with 1 property owner holding 45% of the land area, mostly east of Paseo del Norte. Together, these six property owners own over 75% of the Plan area. See **Exhibit A.40** and **Table A.12**.

TABLE A.12 - PROPERTY OWNERSHIP BY ACREAGE

Acres Owned	# of Owners	% of Owners	Total Acreage	% of Acreage
~20+ Acres	6	19%	432	76%
~10-20 Acres	4	13%	42	7%
~5-10 Acres	13	41%	70	12%
~ < 5 Acres	9	28%	24	4%
Total	32	100%	568	100%

Sources: AGIS, Bernalillo County Assessor, 2010

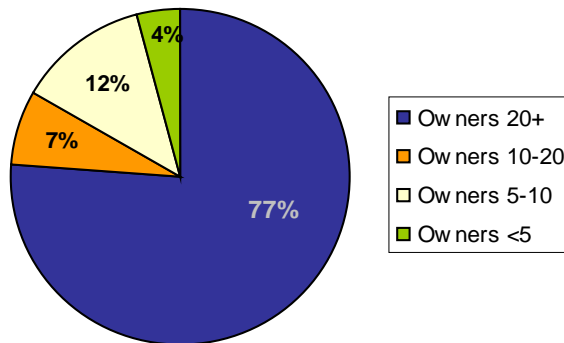

Sources: AGIS, Bernalillo County Assessor, 2010

Exhibit A.40 – Property Ownership by Acreage Chart

Appendix A. Pre-existing Conditions

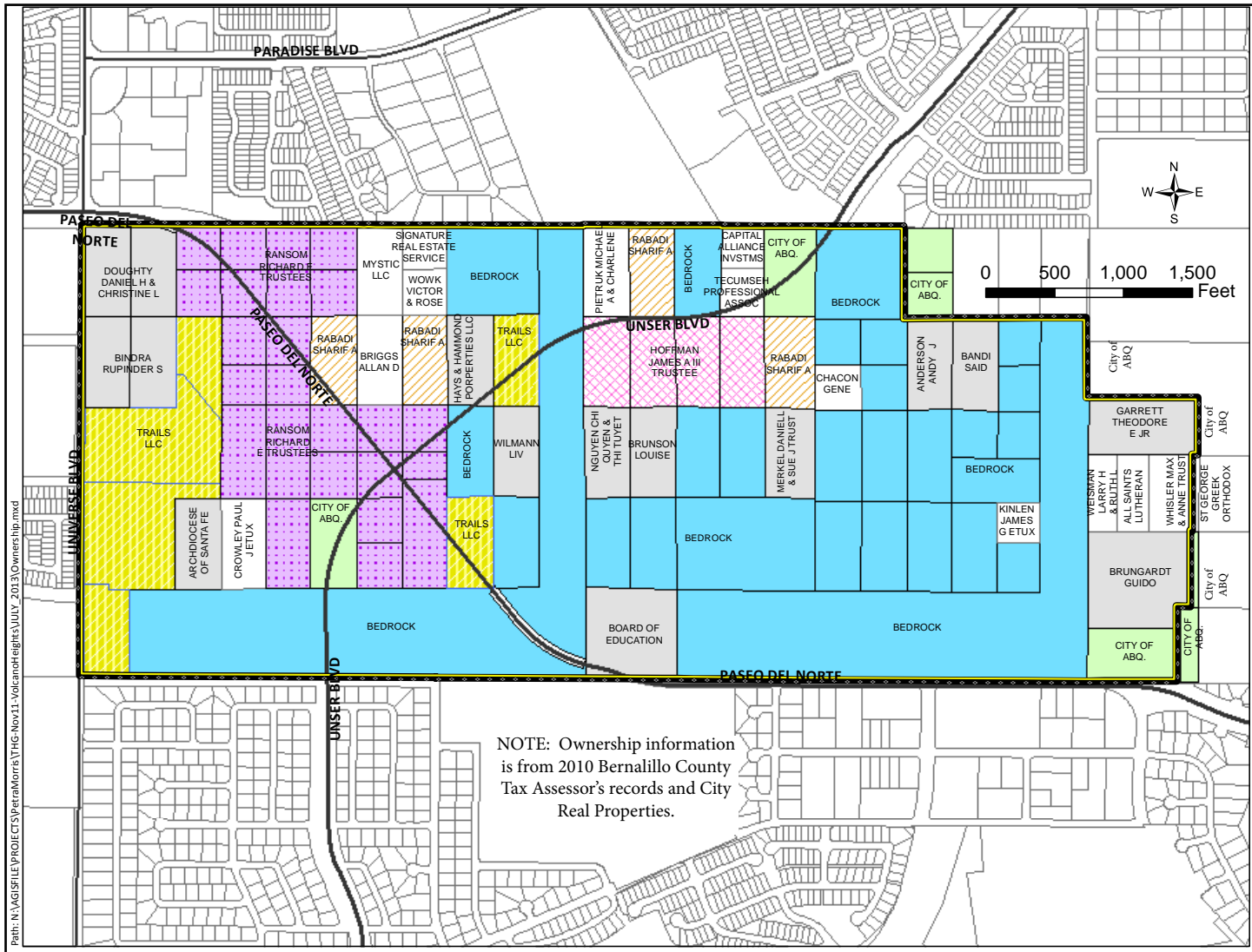

NOTE: Ownership information is from 2010 Bernalillo County Tax Assessor's records and City Real Properties.

Exhibit A.39 – Property Ownership

Appendix A. Pre-existing Conditions

F. Infrastructure

1. Volcano Heights Water & Wastewater Overview

Volcano Heights is located in the 4W & 3WR Pressure Zones within the Volcano and Corrales Service Trunks. Currently, no water or sewer infrastructure exists within the majority of the Volcano Heights study area. Any water service to this area must come from developer-funded line extensions from the surrounding areas. [See **Exhibit A.41.**]

Volcano Heights is outside the existing service areas of the Albuquerque Bernalillo County Water Utility Authority (ABCWUA). As such, any development in the study area will require the execution of a development agreement between the property owners and the ABCWUA.

a. Pre-existing Conditions – Corrales Trunk Water System

- The area north of the study area has been designated as the Corrales Trunk service area. The Corrales Trunk corresponds to the former New Mexico Utility service area.
- Water sources within the Corrales Trunk all require arsenic treatment before the water can be used in the public water system.

b. Pre-existing Conditions – Volcano Trunk Water System

- The Volcano Trunk represents the northernmost water distribution system in the ABCWUA service area prior to the acquisition of New Mexico Utilities.

- Water sources within the Volcano Trunk require arsenic treatment before the water can be used in the public water system.
- Treated San Juan Chama water is used to supplement the water sources within the Volcano Trunk.

c. Pre-existing Conditions – Wastewater

- Wastewater generated within the old New Mexico Utilities (now Corrales Trunk) service area is metered and enters the existing ABCWUA system at several metering manholes located along the Paseo del Norte corridor. [See **Exhibit A.42.**]
- For planning purposes, all of the wastewater generated within the Volcano Heights study area will be contributory to the existing sewer line in Paseo del Norte.

2. Public Service Company of New Mexico

New lines are planned primarily to increase system reliability and serve new stations. New stations and lines are planned to serve load growth in developing areas. PNM has electric facilities within the Plan area as shown in Exhibit A.41 on page A-38. There is an existing 115kV electric transmission line with an approximate right-of-way width of 100 feet on the western boundary of the Plan area and a new Scenic Substation is located west of the Unser Blvd./Rainbow Road NW intersection. [See **Exhibit A.43.**]

[Amended November 5, 2014]

Appendix A. Pre-existing Conditions

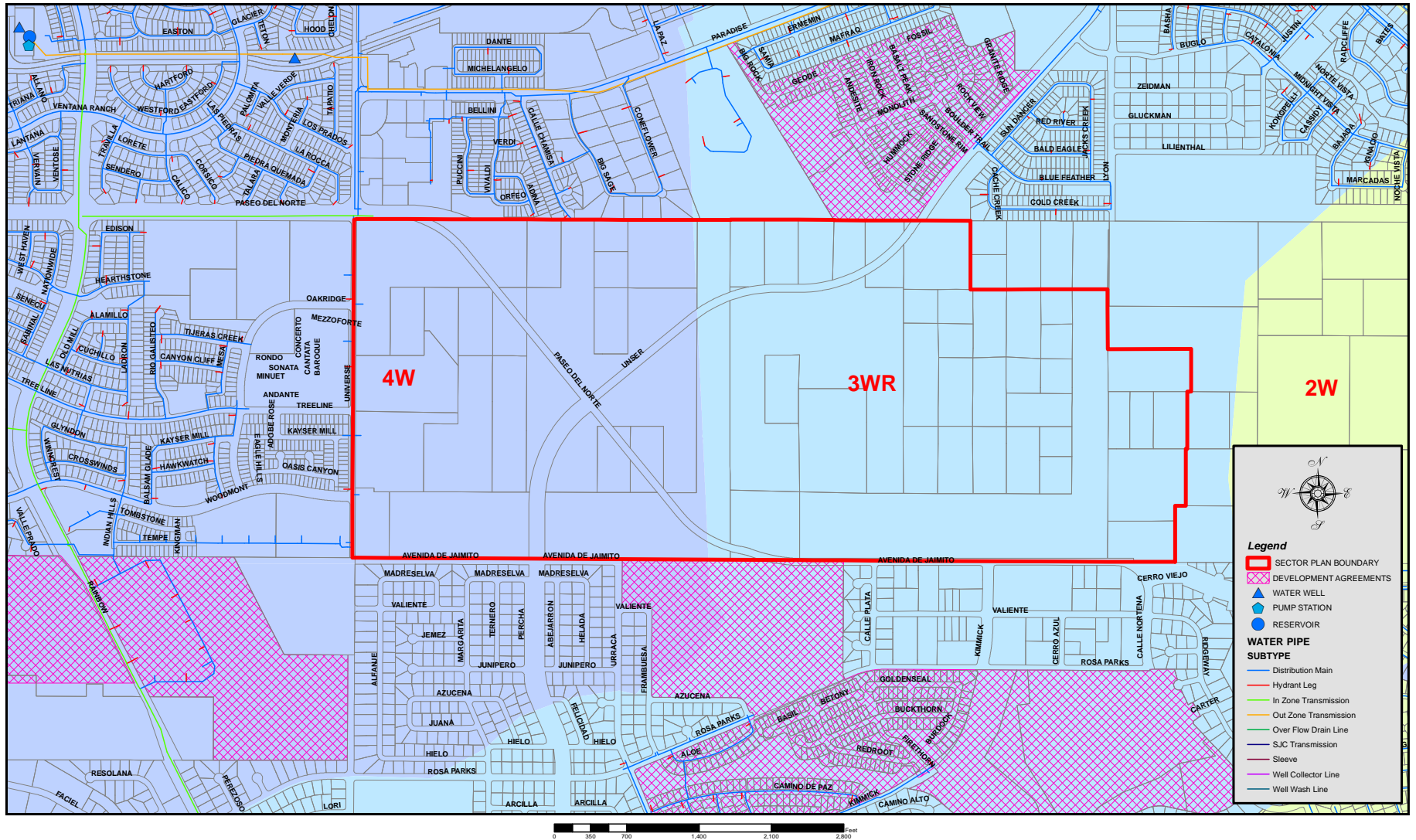

Exhibit A.41 – Existing Water Infrastructure, 2013

APPENDIX

Appendix A. Pre-existing Conditions

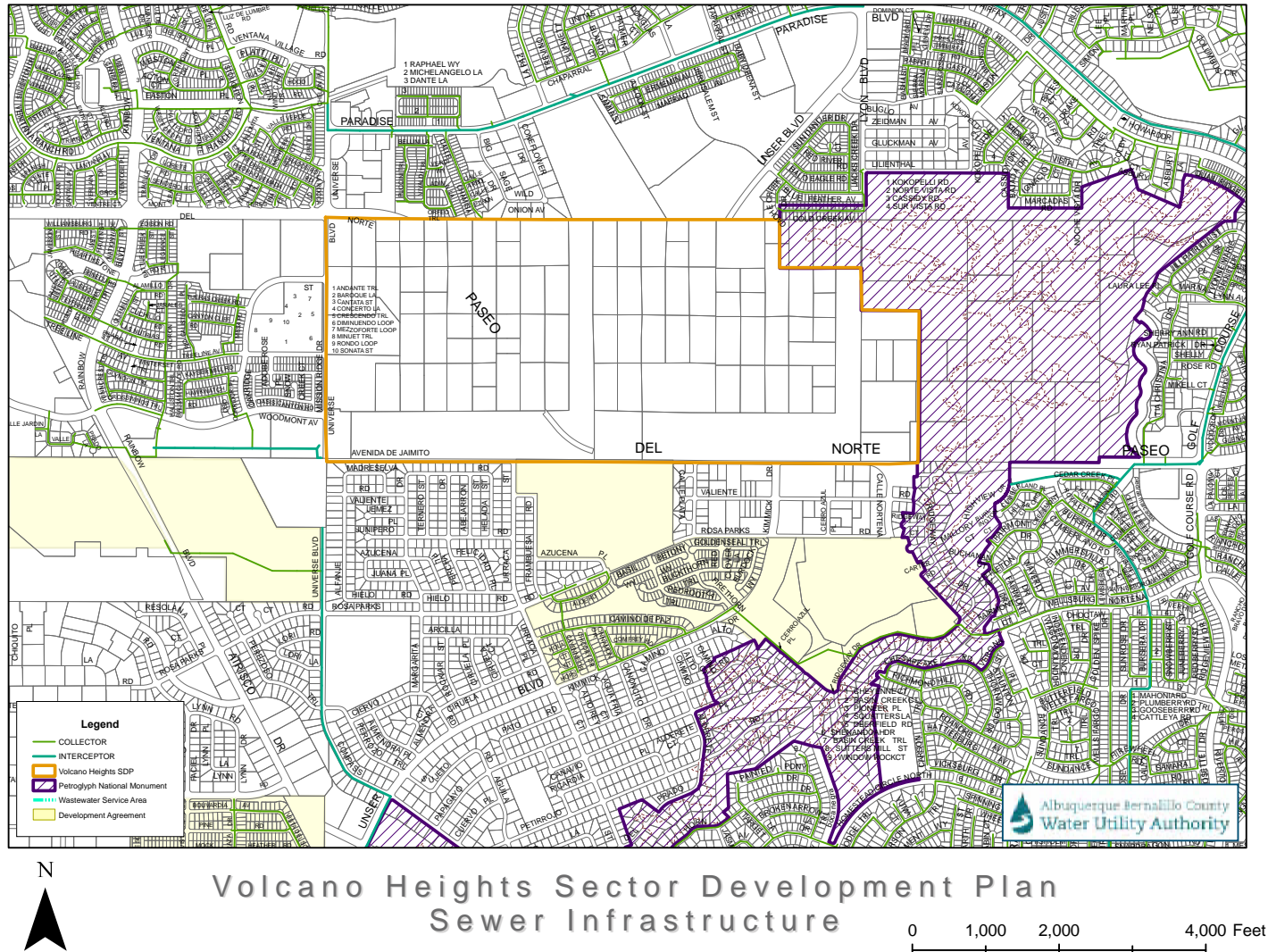

Exhibit A.42 – Existing Sewer Infrastructure, 2012

Appendix A. Pre-existing Conditions

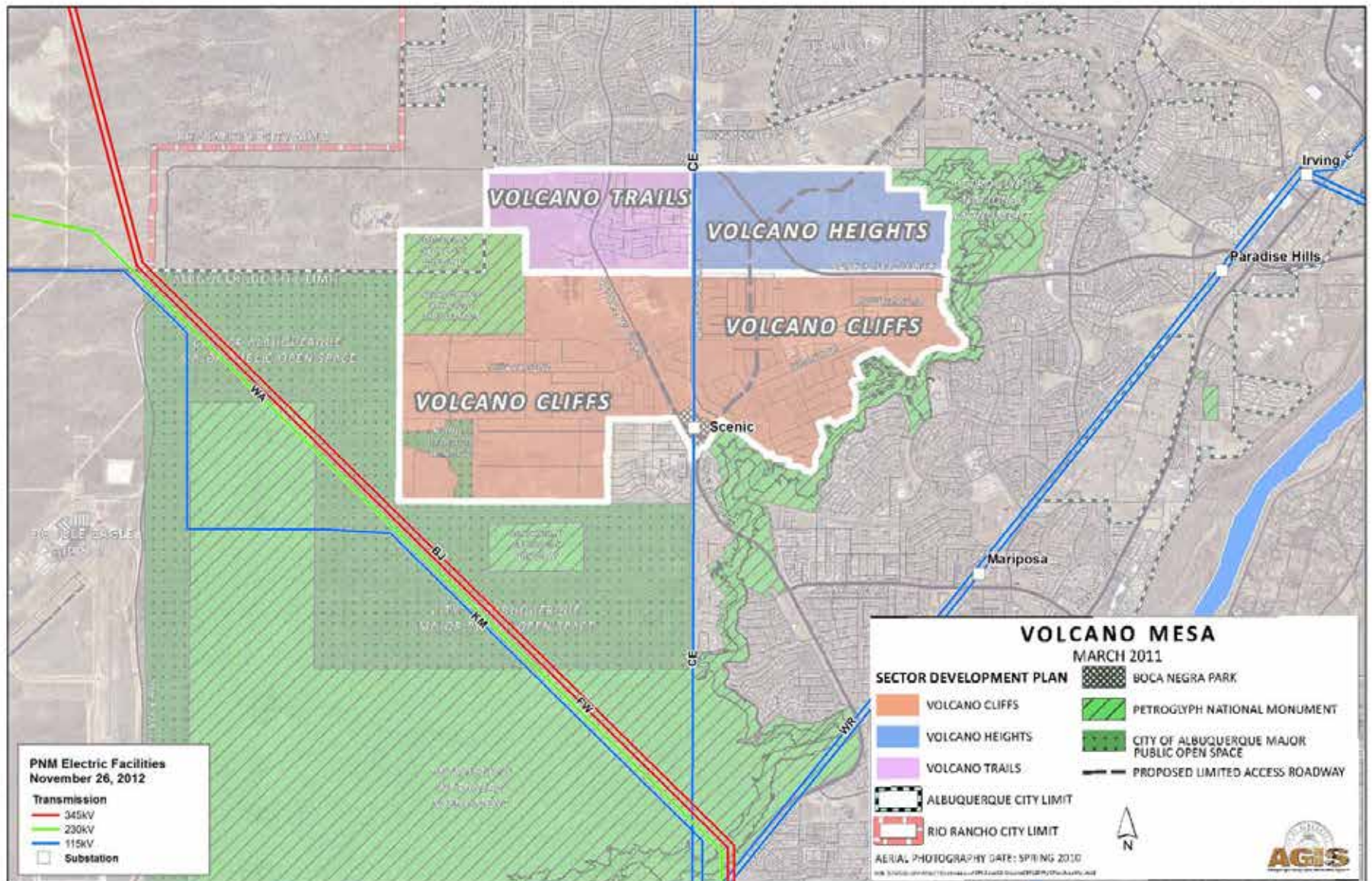

Exhibit A.43 – Volcano Mesa Area Electrical Facilities Map

This Page Left Intentionally Blank

Appendix B

Sector Planning Process

APPENDIX

Appendix B. Sector Planning Process

In 2004, the City Council called for a planning study of Volcano Mesa, an area west of the volcanic Escarpment of the City's Northwest Mesa that includes three Sector Development Plan areas: Volcano Cliffs, Volcano Trails, and Volcano Heights.

The City Council expressed concerns over development trends with subdivisions being approved piecemeal without the guidance of an overall plan for the area, which "has long been considered a unique landscape that requires special protection." The Council recognized the need for a plan that would bring development in line with the West Side Strategic Plan (WSSP), the Northwest Mesa Escarpment Plan (NWMEP), the Albuquerque / Bernalillo County Comprehensive Plan, and other previously established policies and regulations. Issues to be addressed included transportation, drainage, water and wastewater, land uses, view corridors, building height, massing and orientation, walls, parks, trails and open space, and phasing and timing of growth.

The planning study originally forecast over 100,000 additional residents at final build-out in the Volcano Mesa plan area and adjoining areas on the Northwest Mesa and identified how the build out of exclusively single-family residential subdivisions would increase the imbalance of jobs and housing, adding to traffic demands and increasing the burden on West Side and east-west transportation systems. The study identified an overall need for transit-supportive densities and design; additional mixed-use centers; a large-scale, regional, mixed-use employment center; consolidation and connection of open space and trails along drainage channels; and retained access to exceptional views.

The City sought input from stakeholders and property owners in a renewed planning process and used that input to guide the development of the three plans that were based on the original planning effort, but more specifically tailored to the goals and visions of affected stakeholders and property owners of each area.

The planning study led to the original Volcano Heights Sector Plan, which was adopted in 2006 but appealed to district court by the Volcano Cliff Property Owners Association. Upon remand from court, the Plan was divided into three separate, but related, Rank III Sector Development Plans in order to address the diverse needs of and issues within each planning area.

In 2010, at the direction of City Councilor Dan Lewis and Planning Director Deborah Stover, in consultation with area property owners, the Planning Department and Council Services initiated a new approach to developing long-range plans for this special area of Albuquerque. Language related to the overall development of the plan area, including analysis of existing conditions and consideration and general goals and policies for land use, transportation and open space were separated into the companion "Volcano Mesa" amendment to the WSSP, the Rank II Area Plan that governs Albuquerque's West Side.

- The Volcano Cliffs Sector Development Plan (VCSDP), which includes the areas where small lots are individually owned and lower-density residential development will predominate, was adopted in May 2011.
- The Volcano Trails Sector Development Plan (VTSDP), primarily designated for medium-density, single-family residential development held in consolidated ownership, with larger tracts being developed by a master developer, Longford Homes, was adopted in August 2011.
- The Volcano Heights Sector Development Plan (VHSDP) which includes unplatted land in tracts larger than 2 acres, was designated a Major Activity Center by the WSSP Volcano Mesa Amendment. It is intended to include a mix of employment, commercial, and high- and medium-density residential development opportunities.

Appendix B. Sector Planning Process

The Volcano Heights Sector Development Plan was initially submitted to the Environmental Planning Commission in July 2010, after being developed largely by consultant Strata Design, with input from multiple property owners and stakeholders. Initial feedback indicated that some property owners had concerns that certain requirements in the Plan intended to create a dense, urban built environment were unrealistic given market conditions. Other stakeholders had concerns that the Plan would result in development that was too dense, too high, and too intense to coexist with existing residential neighborhoods to the north and south of the Plan area and protect sensitive lands near the Petroglyph National Monument in a unique volcanic, cultural, and historical landscape.

As a result of this feedback, Council Services hired Gateway Planning Group to analyze the Plan regulations to ensure that they were flexible enough to meet market conditions in the short- and long-term. Gateway worked with sub-consultant Gibbs Consulting Group to conduct a market study for office and retail uses to confirm the assumptions underlying the Plan's regulations.

The market study indicated that the original Planning study done in 2004 no longer accurately represented the reduced market potential for retail and office in this area. Gateway confirmed that certain regulations from the July 2010 Draft Plan – such as required parking structures and a minimum 2-story building height – would not provide flexibility for property owners to meet market conditions in the short- and long-term.

The planning team withdrew the July 2010 Draft Plan from the adoption process in October 2011 and worked with Gateway Planning Group, property owners, and stakeholders to rework the Plan based on the following zoning and regulation strategy:

- all mixed-use zones to allow maximum flexibility of land use to match market conditions and opportunities;
- new transition zones to ensure low-density, predominantly residential development adjacent to existing residential neighborhoods and sensitive lands;
- a smaller Town Center zone to concentrate density and create gravity for more urban development;
- a new Regional Center zone lining Paseo del Norte and Unser Boulevard to capitalize on the potential for auto-oriented development along these high-traffic volume, regional roads;
- a network of mandatory roads with frontage standards as well as mandatory building design standards for each character zone to ensure predictability of high-quality development across property lines, along corridors, and over time; and
- a bonus height strategy to balance height and density with additional protections and incentives for preserving sensitive lands.

APPENDIX

Appendix B. Sector Planning Process

The latest sector planning process included public meetings, focus groups, and workshops with property owners and stakeholders, including the following opportunities for public involvement.

Date	Meeting Type	Meeting Focus
April 14, 2011	Interviews	Several large property owners
May 23, 2011	Focus Groups	Results of the market study, analysis of 2010 Draft Plan, and potential zoning strategy changes
June 2, 2011	Public Meetings	Confirming the direction of the zoning strategy
August 23, 2011	Focus Groups	Character Zone Map and Mandatory Roads
September 14, 2011	Focus Groups	Cross Sections and Site Development and Building Design Standards
December 8, 2011	Mini-workshop	Plan Implementation with panel discussions on Economic Development and Infrastructure
March 27, 2012	Public Meeting	Open Space, Trails, Parks and Private Preservation of Sensitive Lands
August 21, 2012	Public Meeting	Results of the traffic study and key components of the Draft Plan

Appendix C

2013 Access Resolution for Paseo del Norte and Unser Boulevard and Traffic Study

This Page Left Intentionally Blank

1 RESOLUTION
2 of the
3
4 TRANSPORTATION COORDINATING COMMITTEE
5 of the
6
7 METROPOLITAN TRANSPORTATION BOARD
8 of the
9
10 MID-REGION COUNCIL OF GOVERNMENTS OF NEW MEXICO
11
12 (R-13-03 TCC)
13

14 **MODIFYING ACCESS ON PASEO DEL NORTE AND UNSER BOULEVARD**
15 **IN THE VOLCANO HEIGHTS SECTOR PLAN AREA**
16
17

18 WHEREAS, the Metropolitan Transportation Board (MTB) is the designated
19 Metropolitan Planning Organization (MPO) for the Albuquerque Metropolitan Planning Area
20 (AMPA); and

21 WHEREAS, the member agencies of the AMPA have agreed that certain roadways
22 are designated as limited access roadways; and

23 WHEREAS, the MTB per Resolution R-05-09 MTB has established *Roadway*
24 *Access Modification Policies*; and

25 WHEREAS, the *Roadway Access Modification Policies* have been implemented to
26 consider requests for access modifications to these roadways; and

27 WHEREAS, the *Roadway Access Modification Policies* designates the
28 Transportation Coordinating Committee (TCC) as the body to consider all requests to
29 modify access on Limited Access Roadways with appeal to the MTB in case of denial; and

30 WHEREAS, the Inventory of Roadway Access Limitations lists all approved access
31 locations and approved modifications (attachment A); and

32 WHEREAS, the Metropolitan Transportation Board has supported planning efforts
33 which integrate land-use policies with the transportation network; and

34 WHEREAS, the City of Albuquerque has proposed the Volcano Heights Sector
35 Development Plan which integrates land-use and transportation by creating a mixed-use
36 activity center that is supportive of high capacity transit and pedestrian walkability while
37 maintaining regional mobility for vehicular traffic; and

38 WHEREAS, the 2035 Metropolitan Transportation Plan designates a proposed bike
39 lane and multi-purpose trail along both Paseo del Norte and Unser Boulevard through the
40 Volcano Heights Sector Development Plan area; and

41 WHEREAS, the Paseo del Norte/Northwest Metro High Capacity Transit Study is
42 expected to recommend an enhanced transit service corridor between the intersection of
43 Unser Boulevard and Southern Boulevard to commercial activity centers near Jefferson
44 Street and I-25, including a connection through the Volcano Heights Sector Development
45 Plan area via a proposed "Transit Boulevard"; and

46 WHEREAS, the urban development pattern envisioned by the Volcano Heights
47 Sector Development Plan supports walking, cycling, and transit in addition to automobile
48 travel, which will require careful planning for travel movements for all transportation modes
49 across the limited access facilities; and

50 WHEREAS, the City of Albuquerque has requested a modification of access on
51 Paseo del Norte NW and Unser Boulevard NW to support development envisioned by the
52 Volcano Heights Sector Development Plan and to implement the policies established by
53 the City of Albuquerque's Rank II West Side Strategic Plan Volcano Mesa Amendment,
54 which emphasizes the importance of multi-modal connectivity within Volcano Mesa and as
55 part of the larger transportation network west of the Rio Grande as well as to serve a

56 dense, compact major activity center within Volcano Heights that provides employment and
57 new housing options on the City of Albuquerque's West Side; and

58 WHEREAS, a major activity center west of the Rio Grande is intended to help offset
59 the imbalance of jobs and housing between the metropolitan area's east and west sides;
60 and

61 WHEREAS, providing more opportunities for employment west of the Rio Grande is
62 intended to reduce the number of river crossings during peak commuter times and help to
63 minimize congestion on river crossings as well as the few key arterials west of the river;
64 and

65 WHEREAS, the intersection of Paseo del Norte and Unser Boulevard is regionally
66 significant to commuter travel; and

67 WHEREAS, the Inventory of Roadway Access Limitations contained several
68 discrepancies of access locations outside the Volcano Heights Sector Development Plan
69 area; and

70 WHEREAS, per Resolution R-05-09 MTB, the TCC is responsible for all access
71 modifications; and

72 WHEREAS, the TCC and MRCOG staff are responsible for maintaining the
73 Inventory of Roadway Access Limitations which lists all approved access locations and
74 approved modifications;

75 NOW, THEREFORE BE IT RESOLVED by the Transportation Coordinating
76 Committee of the Metropolitan Transportation Board of the Mid-Region Council of
77 Governments of New Mexico that the following modifications to access as noted in
78 Attachment A are approved; and

79 BE IT FURTHER RESOLVED that modifications to access on Unser Boulevard and
80 Paseo del Norte are approved as noted in Attachment A with the following stipulations
81 noted below.

82 1. Unser Boulevard from southern boundary of the Volcano Heights Sector Plan
83 area to Blue Feather Avenue/Boulder Trail shall have access restricted to the dedicated
84 streets listed on Attachment A with no additional driveway or vehicular access locations
85 permitted. All access to businesses, residences, etc. shall only be from the local and
86 collector streets to be built in accordance with the Volcano Heights Sector Development
87 Plan.

88 2. Paseo del Norte from Universe Boulevard to Golf Course Road shall have access
89 restricted to the dedicated streets listed on Attachment A with no additional driveway or
90 vehicular access locations permitted. All access to businesses, residences, etc. shall only
91 be from the local and collector streets to be built within the Volcano Heights Sector
92 Development Plan area.

93 3. The intersection of Paseo del Norte and Unser Boulevard shall be reviewed for
94 the construction of a grade separated interchange at such time as traffic congestion and
95 development conditions warrant such review.

96 a). As soon as practical and financially feasible, the TCC shall encourage
97 appropriate agencies to secure funding for the purchase of the necessary
98 rights-of-way to preserve the minimal amount of land required for such a
99 future interchange based on an estimate acceptable to the New Mexico
100 Department of Transportation, the City of Albuquerque and Bernalillo County.

101 b). Upon recommendation to construct a grade-separated interchange, the TCC, as
102 the committee responsible for the development of the Transportation

103 Improvement Program (TIP), shall review funding options for the design and
104 construction of an urban, multi-modal, grade separated interchange which
105 shall accommodate cyclists, pedestrians, transit movements and vehicular
106 traffic in all travel directions and incorporates best practices for multi-modal
107 design.

108 c). The grade-separated interchange will be designed to complement the urban
109 development pattern envisioned by the Volcano Heights Sector Development
110 Plan and minimize impact on surrounding development, adjacent roadways,
111 and nearby trails and open space.

112 4. The first intersection on Unser Boulevard south of Paseo del Norte (approximately
113 1,027 feet south) shall remain unsignalized until such time as a grade separated
114 intersection at Paseo del Norte and Unser Boulevard is constructed and shall be designed
115 to accommodate safe crossings for pedestrians and cyclists.

116 5. The intersection of the proposed transit boulevard and Paseo del Norte (located
117 approximately 2,695 feet east of Unser Boulevard) is approved for a "High-T" intersection
118 which, to the extent practical, preserves the eastbound-through, free-flow movement on
119 Paseo del Norte with a dedicated eastbound to northbound left-turn lane and a southbound
120 to eastbound left-turn lane combined with an eastbound merge lane, in order to minimize
121 traffic signal phasing and cycle length and to minimize red-signal time for Paseo del Norte.

122 a). Until such time as Paseo del Norte is constructed to a four or six lane facility and
123 the "High-T" intersection is constructed, the intersection may be constructed
124 as a traditional at-grade, signalized intersection.

125 PASSED, APPROVED, AND ADOPTED this 12th day of July 2013 by the
126 Transportation Coordinating Committee of the Metropolitan Transportation Board of the
127 Mid-Region Council of Governments of New Mexico.

128
129
130
131
132
133
134
135
136
137
138
139
140
141

George Bootes, Chairman
Transportation Coordinating Comm.

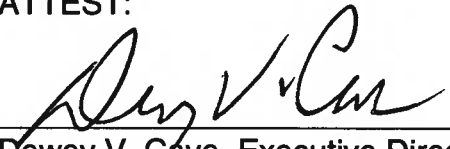
ATTEST:

Dewey V. Cave, Executive Director
Mid-Region Council of Governments

Refer to R-13-03 TCC Attachment A for listing of all approved access modifications revised by this resolution.

R-13-03 TCC Attachment A

Inventory of Roadway Access Limitations

Some arterial roadways in the Albuquerque Metropolitan Planning Area (AMPA) have a greater degree of access limitations in order to increase their primary function of moving large volumes of traffic. It is intended that the local government represented on the Metropolitan Transportation Board (MTB) which has jurisdiction over the adjacent land and/or affected facility will coordinate access to lands along that facility. It is further intended that, for those facilities under the jurisdiction of the State of New Mexico, the responsible local government shall coordinate the proposed actions with the New Mexico Department of Transportation. In either case, it is expected that the local government with jurisdiction over adjacent land will notify all affected property owners of record as to the nature of the limitations proposed and of the process by which the policy will be maintained or modified.

The original access limitations for proposed and existing facilities were established by resolution of the MTB. The resolution number(s) is shown within parenthesis after each facility name.

On August 25, 2005, the Metropolitan Transportation Board approved resolution **R-05-09 MTB**. The resolution established the Access Limitations as a stand-alone policy separate from the FAABS, adopted a procedure for modifying access points, and delegated authority to the Transportation Coordinating Committee (TCC) to implement access policy and approve variances from that policy.

KEY

Proposed changes in blue text in yellow shading are those modifications due to the Volcano Heights Sector Development Plan.

Proposed changes in red text are those modifications to correct discrepancies and are **NOT** due to the Volcano Heights Sector Development Plan.

Coors Boulevard (NM 45 part)

A. Coors Boulevard (R-81-07, R-84-06, R-84-09, R-86-07, R-86-22, R-93-11, R-95-2, R-95-21, R-01-24, R-03-02, R-05-15, R-13-01)
Primary access to Coors Boulevard from Arenal Road to N.M. 528 is as described below. Right-in/right-out and driveway accesses are described in the Coors Corridor Plan. Additional restrictions may be imposed as per the adopted Coors Corridor Plan.

1. Arenal Road to Central Avenue	As currently (July 1986) designed
	a. Central Avenue (full intersection)
	b. Bluewater Road (full intersection)
	c. Fortuna Road (full intersection)
	d. Hanover Road (full intersection)
	e. I-40 Interchange (full intersection)
	f. Los Volcanes Road (full intersection)
	g. Quail Road (full intersection)
	h. Sequoia Road (full intersection)
	i. St. Joseph's Drive (full intersection)
	j. Western Trail (full intersection)
	k. Southerly portion of La Luz (full intersection)
	l. Dellyne Avenue (full intersection)
	m. Montaña Road (full at-grade intersection; future interchange)
	n. Montaña Plaza Drive (full intersection)
2. Central Avenue to N.M. 528	o. 1,400 feet south of Montaña (left in) R-05-15
	p. La Orilla Road (full intersection)
	q. Roberson Lane (left-in from southbound Coors Blvd) R-13-01 TCC
	r. Midpoint between El Malecon and La Rambla (access to the east only)
	s. Eagle Ranch Road (full intersection)
	t. Paseo del Norte (interchange)
	u. Irving Boulevard (full intersection)
	v. Coors By-Pass (interchange)
	w. Coors Bypass - northerly entrance to Cottonwood Mall (left-in/right-in/right-out access only)
	x. Eagle Ranch Road - intersection with Coors By-Pass (full intersection)
	y. Seven-Bar Loop Road - intersection with Coors By-Pass (full intersection with right turns only from Seven-Bar Loop Road)
	z. Ellison Drive - intersection with Coors By-Pass Road (interchange)
	aa. N.M. 528 - intersection with Coors By-Pass (interchange)

Gibson Boulevard

B. Gibson Boulevard (R-86-5, R-86-9, R-89-15, R-90-11, R-91-9, R-96-4, R-95-21, R-03-11, R-03-31, R-04-04, R-07-03 TCC, R-07-04 TCC)

1. I-25 to San Mateo Boulevard	High-capacity, high-speed, limited access Principal Arterial	b. Use by heavy trucks is restricted.	
		c. I-25 frontage road (east side) to Mulberry - No access allowed	
		a. Full access is limited to the following approximately one-half mile at-grade intersections	1) I-25 frontage Road
			2) Midway between Mulberry and University - T intersection to the north
c. Partial access is limited to the following locations:	3) University Boulevard		
	4) Yale Boulevard		
	5) Girard Boulevard		
	6) San Mateo Boulevard		
2. San Mateo Boulevard to Louisiana Boulevard	Principal Arterial with full access limited to approximately one-quarter mile intervals, right-in/right-out driveway access allowed, and provision for emergency vehicle access where required		
3. Louisiana to Juan Tabo Boulevard	a. High-capacity, high-speed, limited access Principal Arterial with access limited to approximately one-half mile at-grade intersections.	1) Eubank Boulevard	
		2) Elizabeth Street	
	b. Right-in/right-out access at one-quarter mile intervals if required	3) Juan Tabo Boulevard	
		1) Eubank Boulevard to Elizabeth Street at approximately one-quarter mile intervals both north and south (right-in/right-out access)	
c. Shall follow the north alignment and lie entirely on KAFB property to Eubank Boulevard East of Eubank Boulevard the corridor will follow and encompass existing Southern Boulevard	2) Elizabeth Street to Juan Tabo Boulevard at approximately one-quarter mile intervals both north and south (right-in/right-out access)		
	1) Southern Avenue at Stephen Moody (right-in/right-out/left-in) R-07-03 TCC		

Juan Tabo Boulevard

C. Juan Tabo Boulevard (R-86-9, R-91-09)

1. Gibson Boulevard to I-40	Full access only at Central Avenue and I-40
2. Intersection of Skyline Road and Juan Tabo Boulevard	T-intersection to the east with a median opening

McMahon Boulevard

D. McMahon Boulevard (R-2000-11, R-05-10)

Access is provided for full intersections along McMahon Boulevard at approximately 1000 foot intervals. Access is provided for T intersections and right-in/right-out driveways provided they are no closer than approximately 400 feet to adjacent intersections.

Right-in, Right out access at:	1. Approx. 370 feet west of Golf Course Rd R-05-10 MTB
--------------------------------	---

Montaño Road

E. Montaño Road (R-80-5, R-84-9, R-86-14)

No access shall be permitted between Coors Boulevard and just east of Rio Grande Boulevard

Paseo del Norte (NM 423)

F. Paseo del Norte (R-85-3, R-86-8, R-86-15, R-86-17, R-86-24, R-88-6, R-01-24, R-03-26, R-05-13, R-06-01 TCC, **R-13-03 TCC**)

A potential future freeway type facility from Coors Boulevard to Louisiana Boulevard, Paseo del Norte shall be a limited access Principal Arterial. Access to Paseo del Norte ~~shall be permitted only as specified by resolution of the MTB and~~ shall be limited to one of the following three types of interchange intersections. These three types are defined and locations of access are specified below.

TYPE A: Interchange configuration

TYPE B: At-grade dedicated street intersection with median opening

TYPE C: At-grade dedicated street intersection without median opening

TYPE A: Interchange configuration	1. Paseo del Volcan - NM347 (initially at-grade; future grade-separation as needed) R-13-03 2. Unser Boulevard (future grade-separation) R-13-03 TCC 3. Coors Boulevard 4. 2nd Street 5. Jefferson Street (grade-separation under project CN A301180) R-13-03 TCC 6. I-25
TYPE B: At-grade dedicated street intersection with median opening and traffic signalization, as warranted. At approximately one-half mile intervals, or as identified on the Long Range Roadway System, and specifically located at the following intersections. Additional Type B intersections may be permitted if they subsequently are added to the Long Range Roadway System and meet the approximate one-half mile interval criteria.	1. Atrisco Vista Blvd. (formerly Paseo del Volcan East & Double Eagle II Rd.) 2. Boulevard del Oeste, extended 3. Woodmont Avenue-Ventana West Parkway R-06-01 TCC 4. Rainbow Boulevard 5. Universe Boulevard 6. A new street approx. 1,550 feet east of Universe Blvd. and 1,518 feet west of Unser Blvd. R-13-03 TCC 7. Unser Boulevard (at-grade until future grade-separation is needed) R-13-03 TCC 8. A new street approx. 1,410 feet east of Unser Blvd R-13-03 TCC 9. A new street (aka "Transit Blvd" in Volcano Heights Sector Plan) approx. 2,695 feet east of Unser Blvd and 1,816 feet west of Kimmick Dr. This intersection is approved for a "High-T" type of intersection which, to the extent practical, preserves the eastbound-through, free-flow movement, and a dedicated eastbound to northbound left-turn lane along with a southbound to eastbound left-turn lane including an eastbound merge lane, in order to minimize traffic signal phasing and cycle length for Paseo del Norte to minimize red-signal time. R-13-03 TCC 10. Kimmick Drive 8. Taylor Ranch Corridor (T-intersection to the south) 11. Golf Course Road 12. Unnamed Collector midway between Eagle Ranch Road and Golf Course Road (now called Rancho Sereno Road & Richland Hills Road) 13. Eagle Ranch Road 12. Jefferson Street 14. San Pedro Drive 15. Louisiana Boulevard 16. Wyoming Boulevard 17. Barstow Street 18. Ventura Street 19. Holbrook Street 20. Eubank Boulevard 21. Browning Street 22. Lowell Street 23. Tramway Blvd
TYPE C: At-grade dedicated street intersection <u>without</u> median opening	1. Calle Plata (right-in/right-out only on south side of Paseo del Norte) R-13-03 TCC 2. Calle Norteña (right-in/right out only on south side of Paseo del Norte) R-13-03 TCC 3. Park Edge Drive, a new street approx. 1,723 feet east of Kimmick Dr. (right-in/right-out only on north side of Paseo del Norte) R-13-03 TCC 4. Mid block between Wyoming & Barstow (right in/right out) R-05-13 MTB 5. Rancho de Palomas (south side of Paseo del Norte between Wyoming and Louisiana) 6. Between I-25 and San Pedro Boulevard, to serve the south side parcel to and from Paseo del Norte
Access Prohibition	Access Prohibition: Paseo del Norte between Universe Boulevard and Golf Course Road shall have access restricted to the dedicated streets granted access above with no additional driveways or vehicular access locations permitted. All access to businesses, residences, etc. shall only be from the local and collector streets existing or to be built. R-13-03 TCC

Paseo del Volcan (NM 347)

G. Paseo del Volcan Western Alignment (R-82-12, R-86-22, R-90-13, R-93-8, R-03-17)

A high-speed, high-capacity, limited access principal arterial from I-40 on the south to US550. It is the desire of the MTB that Paseo del Volcan shall ultimately be developed to freeway standards and that ultimate access shall be provided via interchanges at approximately 1 mile intervals. Prior to ultimate development, at-grade intersections with median openings at other than one-mile intervals may be permitted **when approved by the MTB**. When ultimate access control on Paseo del Volcan is implemented, reasonable access will be provided to adjacent properties. An access control plan for adjacent and intersecting streets shall be developed through subsequent location corridor studies. The following access policy has been established.

I-40 on the south to US550 on the north Limited to approximately one-mile intervals, as follows:	1. Approximately 1.4 miles north of I-40
	2. Approximately 2.5 miles north of I-40
	3. Approximately 3.6 miles north of I-40
	4. Approximately 4.6 miles north of I-40, on the north boundary line of the Town of Atrisco Grant
	5. Approximately 7.8 miles north of I-40, on the south boundary line of the Town of Alameda Grant
	6. Approximately 9.6 miles north of I-40, at proposed Paseo del Norte
	7. Approximately 10.7 miles north of I-40
	8. 19th Avenue
	9. Southern Boulevard
	10. West Sandia Boulevard
	11. Northern Boulevard
	12. 19th Avenue North
	13. Vista Road
	14. Rainbow Boulevard
	15. 20th Street (Unser Boulevard)
	16. 30th Street
	17. 40th Street
	18. Iris Road
	19. Lincoln Avenue
	20. Approximately 1.1 miles north of Lincoln Avenue

Atrisco Vista Boulevard

(formerly Double Eagle II Road or Paseo del Volcan Eastern Alignment)

H. Atrisco Vista Boulevard (Paseo del Volcan Eastern Alignment) (R-03-17, R-04-01, R-13-03 TCC)

A high-speed, high-capacity, limited access principal arterial from the southern terminus at Senator Dennis Chavez Boulevard to the northern terminus at Southern Boulevard in Rio Rancho. The purpose of Paseo Del Volcan (Eastern Alignment) is to provide a relatively high-speed regional roadway connecting Paseo Del Norte with I-40, reasonable direct access to the Double Eagle II Airport from both Paseo del Norte and I-40, and limited but viable access to commercial and residential properties adjacent to the roadway. The following access policy has been established:

1. Senator Dennis Chavez Boulevard to I-40.	a. Full intersection permitted at:	1). Senator Dennis Chavez Boulevard R-13-03 TCC 2). Tierra West Estates Road approx. one-half (½) mile south of Central Ave.
	b. Access between Tierra West Estates Road and Senator Dennis Chavez Boulevard shall be provided for full intersections at approximately one half mile intervals and for "T" intersections and right-in/right-out driveways at approximately one-quarter mile intervals.	
2. I-40 to Double Eagle II Airport southern boundary.	a. No intersections and/or driveways permitted between I-40 and 1/2 mile north of I-40	1) 3,460 feet north of I-40 2) Ladera Drive 3) 118th Street 4) 98th Street 5) Upper Street
	b. Full intersection permitted only at:	
	c. "T" intersections and right-in/right-out driveways permitted at approximately one-quarter mile intervals between 1/2 mile north of I-40 and Double Eagle II Airport, as follows:	4,580 ft north of I-40 - right-in/right-out
3. Double Eagle II Airport southern boundary to Double Eagle II Airport northern boundary.	No access permitted except as prescribed by the Double Eagle II Airport Master Plan.	
4. Double Eagle II Airport northern boundary to Southern Boulevard in Rio Rancho.	a. Full intersection permitted only at:	1). Paseo del Norte R-13-03 TCC 2). Southern Boulevard R-13-03
	Access shall be provided for "T" intersections and right-in/right-out driveways at approximately one-quarter mile intervals.	

Rio Bravo Boulevard & Sen. Dennis Chavez Blvd. (NM 500)	
I. Rio Bravo (R-85-13, R-86-9, R-86-31, R-88-8, R-90-5, R-01-24, R-05-11, R-05-14, R-10-01, R-12-02 TCC & R-12-10 MTB) A high-speed, high-capacity limited access Principal Arterial between I-25 and Paseo del Volcan Western alignment	
<p>1. Full interchange, at-grade Street intersections shall occur at one-half mile intervals and shall be limited to at-grade street intersections with median openings and traffic signalization, as warranted, or interchange configurations. These intersections shall be located at the identified locations. Additional at-grade street intersections with median openings or interchanges may be permitted at approximately one-half (½) mile intervals if added to the Long Range Roadway system.</p>	a. Paseo del Volcan (aka NM 347)
	b. Atrisco Vista Boulevard (formerly Paseo del Volcan)
	c. 118th Street
	d. 98th Street
	e. Unser Boulevard
	f. Condershire Drive
	g. Coors Blvd
	h. Sunstar Drive
	i. La Junta Drive
	j. Del Rio Road
	k. Isleta Boulevard
	l. Poco Loco Drive
	m. 2nd Street
	n. Prince Street
	o. Broadway Boulevard
p. University Boulevard	
q. San Mateo Blvd	
<p>2. I-25 to Coors Boulevard SW: Right-in/right-out access may be permitted without median openings approximately one-fourth (¼) mile from the nearest permitted intersection if special conditions are demonstrated and the location of such access points is approved by the MTB.</p>	a. Access to eastbound Rio Bravo Boulevard, just east of the San Jose Drain between 2nd and Prince Street.
	b. Approximately 660 feet west of Coors Blvd, right in/right out/left in R-06-03 TCC
	c. Westbound right turn deceleration lane between Prince Street and 2nd Street; TRANSIT ONLY left in/right out R-07-01 TCC
	d. A right-in/right-out on the north side of NM 500 between the South Diversion Channel and NM 47 with deceleration lane as far west as practical. R-12-02 TCC & R-12-10 MTB
	e. Approximately 250 feet east of Broadway Blvd. Right-turn in only is permitted on north side of Rio Bravo
	f. Approx. 400 feet east of Broadway (right in/right out) R-05-11 MTB
	g. 1,130 feet east of Broadway (right in/right out/ left in) R-05-14 MTB
4. Loris Drive (along the west side of Isleta Drain)	T-intersection is allowed
5. Approximately midway between 98th and 118th	T-intersection is allowed for access to the south for Atrisco Heritage Academy High School Events Field.

San Mateo Boulevard	
J. San Mateo Boulevard (R-86-9, R-86-14, R-86-22) Access to San Mateo Boulevard between I-40 and the Rio Bravo East Extension Corridor shall be as listed below.	
1. I-40 to Zuni Road	As currently (July 1986) provided
2. Zuni Road to Gibson Boulevard	a. As shown in the final design.
	b. Northbound directional left-turn median opening between Kathryn Avenue and Southern Avenue
3. Gibson Boulevard to the Rio Bravo East Extension Corridor	High degree of access control

Tramway Boulevard (NM 556)

K. Tramway Boulevard (R-82-3, R-82-10, R-84-19, R-86-13)	
A general policy of limiting full access to approximately one-half mile spacing with the specific access controls listed below.	
1. I-40 to Montgomery Boulevard	As currently (July 1986) constructed
2. Montgomery to the Sandia Indian Reservation	a. Montgomery Boulevard (full intersection)
	b. Vicinity of southern boundary of Elena Gallegos Grant (T-intersections east and west with no median opening)
	c. Manitoba Street (full intersection)
	d. Spain Road (full intersection)
	e. Academy Road (full intersection)
	f. Simms Park access road (T-intersection east with median opening)
	g. San Rafael Avenue (full intersection)
	h. Tramway Terrace (full intersection)
	i. San Bernardino Avenue (full intersection)
	j. Paseo del Norte (T-intersection west with median opening)
	k. Live Oak Road (full intersection)
	l. Alameda Boulevard/Cedar Hill Road (full intersection)
	m. Tramway Lane (full intersection)

Unser Boulevard

L. Unser Boulevard (R-84-15, R-85-8, R-87-11, R-89-16, R-92-3, R-93-7, R-95-2, R-95-21, R-2000-11, R-2001-9, R-2001-11, R-02-17, R-03-19, R-2001-24, R-03-25, R-04-19, R-04-28, R-05-01, R-05-12, R-06-02 TCC, R-08-01 TCC, R-09-01 TCC, R-09-02 TCC, R-12-01 TCC, R-13-02 TCC, R-13-03 TCC)			
A high capacity, limited access Principal Arterial from Gun Club Road to US 550 with full access at-grade intersections at one-half mile intervals. Right-in, right-out access points may be located at approximately one-quarter mile intervals, provided the access location does not degrade traffic flow and upon review by the TCC and approval by the MTB. This policy will serve as guidance to future corridor or access studies for Unser Boulevard south of Gun Club. Access is provided as listed below.			
1. Rio Bravo Boulevard To Central Avenue	a. Full-access intersections at:	1) Rio Bravo (Senator Dennis Chavez) Boulevard	
		2) Midway between Rio Bravo and Blake Road	
		3) Blake Road	
		4) Gibson Boulevard w/ Spring Flower Road	
		5) Arenal Road/Sapphire Road	
		6) Sage Road	
		7) Tower Road	
		8) Bridge Boulevard	
	b. Partial-access intersections at:	1) Freshwater Road (right-in/right-out access to the east)	
		2) Kimela Drive (right-in/right-out access to the west)	
		3) West side of Unser approximately 800 feet south of Sage Road right-in/right-out/left-in R-08-01 TCC	
		4) Right-in on east side of Unser approximately 500 feet south of Sage Road. R-10-04 TCC	
		5) Midpoint between Sage Road and San Ygnacio Road (right-in/right-out) R-09-02 TCC	
		6) San Ygnacio Road (right-in/right-out access to the east and west); (Southbound Unser to Eastbound San Ygnacio left turn) R-09-02 TCC	
		7) 475 feet north of the centerline of Tower Road (right-in/right-out access to the east)	
		8) Eucariz Avenue (right-in/right-out access to the east and west)	
		9) Sunset Gardens Road (right-in/right-out access to the west)	
		10) Gwin Road (right-in/right-out access to the east)	
		11) Frederick Lane (right-in/right-out access to the east)	

Unser Boulevard continued			
2. Central Avenue to Ouray Road	a. Full access intersections at:	1) Central Avenue	
		2) Bluewater Road	
		3) Los Volcanes Road	
		4) Interstate 40 (grade-separated full interchange)	
		5) Ladera Drive	
		6) 98th Street (a.k.a. Tierra Pinta Blvd.) & Vista Orienta Street	
	b. Partial access intersections at approximately one-quarter mile intervals shall be provided at the following specified locations:	1) Central Avenue to Bluewater Road - Access to the east at Sarracino Place until the adjacent properties redevelop or when the ultimate roadway is constructed. Permanent access will be reevaluated at that time through a traffic study.	
		2) Saul Bell Road - Left-turn bay from Unser Blvd northbound to Saul Bell Road westbound. R-12-01 TCC	
		3) Bluewater to Los Volcanes Road - east side of Unser approximately 700 feet north of Bluewater (right-in/right-out access)	
		4) La Miranda Plance - Access to the east at "La Mirada" (right-in and right-out)	
5) Old Ouray Road - Access to the east at "Old Ouray Road", approx. 950 ft south of Ouray Road (New) and Unser Boulevard (right-in and right-out)			
6) Unser approximately 475 feet north of centerline of 98th Street - right-in R-04-19 MTB			
7) 950 feet south of Ouray (right-in right-out, on the east side) [now called Brawley Rd]			
3. Ouray Road and Dellyne Avenue	a. Full access, at-grade intersections	1) Ouray Road & Lava Bluff Drive	
		2) St. Joseph's Avenue	
		3) Western Trail & Petroglyph Park Road	
	b. Partial access intersections at approximately quarter mile intervals	1) Ouray Road to St. Joseph's	a) West at St. Joseph's Loop (right-in and right-out)
			b) East at Vista Allegre Street (right-in/right-out)
		2) St. Joseph's Avenue to Western Trail	a) West at Lava Shadows Loop (right-in/right-out)
			b) East - location to be coordinated with property owners (right-in/right-out) [now called Boca Negra Pl.]
		3) Western Trail to Dellyne Avenue	a) West at Vulcan Parkway (right-in/right-out with a directional north-to-west left turn only)
			b) East between the proposed Atrisco Drive cul-de-sac and the San Antonio Arroyo - location to be coordinated with property owners (right-in/right-out) [now called Sipapu Ave]
			c) East between the San Antonio Arroyo and Dellyne Avenue (right-in/right-out) [now called Azuelo Ave]

Unser Boulevard continued		
4. Dellyne Avenue to Paradise Boulevard	a. limited to full access at-grade intersections at the specified locations:	<p>1) Dellyne Avenue & Astair Avenue R-13-03 TCC</p> <p>2) Montaña Road</p> <p>3) Atrisco Road (T-intersection to the east) (With the new alignment of Unser, this street takes the place of formerly approved T-intersection for Santo Domingo St.)</p> <p>4) 81st Street (T-intersection to the west)</p> <p>4) Molten Rock Rd R-13-03 TCC</p> <p>5) Rainbow Blvd (formerly listed as Compass Drive)</p> <p>6) Kimmick Drive (unsignalized T-intersection to be converted to right-in/right-out once the intersection would require a traffic signal.) R-13-03 TCC</p> <p>7) Rosa Parks Avenue (formerly listed as Squaw Rd)</p> <p>8) A new street approx. 1,027 feet south of Paseo del Norte and 2,791 feet north of Rosa Parks Ave. R-13-03 TCC</p> <p>9) Paseo del Norte (at-grade intersection until grade-separation is needed) R-13-03 TCC</p> <p>9a) A temporary access approx. 400 feet north of Paseo del Norte R-13-02 TCC</p> <p>10) A point approximately halfway between Paseo del Norte and Lilienthal-Blue Feather/Boulder Trail approx. 2,389 feet north of Paseo del Norte which corresponds to the location of the "Transit Blvd" proposed in the Volcano Heights Sector Plan.</p> <p>11) Blue Feather/Boulder Trail (With the new alignment of Unser, this street takes the place of the formerly approved full-intersection for Lilienthal Ave.)</p> <p>12) Paradise Boulevard</p>
	b. Partial access intersections shall be provided at the specified locations:	<p>1) Flor del Sol Place (unsignalized T-intersection to be converted to right-in/right-out once the intersection would require a traffic signal.) R-13-03 TCC</p> <p>2) Bogart Street (unsignalized T-intersection to be converted to right-in/right-out once the intersection would require a traffic signal.) R-13-03 TCC</p> <p>3) Kimmick Drive (unsignalized T-intersection to be converted to right-in/right-out once the intersection would require a traffic signal.) R-13-03 TCC</p> <p>4) A new street approx. 1,105 feet north of Paseo del Norte (right-in/right-out on east side of Unser Blvd. and a right-in/right-out on west side of Unser Blvd. No median break for either side.) R-13-03 TCC</p> <p>4) A new street approx. 1,160 feet south of Blue Feather/Boulder Trail (right-in/right-out on east side of Unser Blvd. and a right-in/right-out on west side of Unser Blvd. No median break for either side.) R-13-03 TCC</p> <p>4) Buglo Avenue (right in/right out/left in) R-07-02 TCC</p>
	Access Prohibition	<p>Access Prohibition: Unser Boulevard within the Volcano Heights Sector Plan area shall have access restricted to the dedicated streets granted access above with no additional driveways or vehicular access locations permitted. All access to businesses, residences, etc. shall only be from the local and collector streets to be built in the development(s). R-13-03 TCC</p>

Unser Boulevard continued		
5. Paradise Boulevard to Southern Boulevard	a. Access shall be limited to full access at-grade intersections at the specified locations:	1) Cabezon Boulevard
		2) Westside Boulevard
		3) Wellspring Ave/Rhonda Ave R-09-03 TCC
		4) Arroyo Road (Healthy Way); signalized "T" Intersection (City of Rio Rancho correspondence on June 20, 2008 - three-party agreement with City of Albuquerque and NMDOT) Full Inter under R-09-03 TCC
		5) Night Whisper Road (approximately 1,200 feet north of McMahon)
		6) McMahon Boulevard
		7) Arenal Road/Sapphire Road
		8) Bandelier Drive
		9) Irving Boulevard
		10) Paradise Boulevard
		11) Exception: The Bernalillo County Volunteer Fire Department No. 7, located immediately north of Paradise Boulevard, shall be provided with access to Unser Boulevard, including a median opening for the express purpose of serving this fire station. The median opening and driveway access to the station will be closed when Fire Department No. 7 is relocated.
		12) Commercial Drive (right in/ right out/ left in) R-05-12 MTB
	b. Partial accesses allowing only for left turns from Unser Boulevard and right-in/right-outs from the adjacent parcels shall be allowed at:	1) 700 feet north of McMahon
		2) 700 feet south of McMahon
		3) 700 feet north of McMahon (access point changed to 450 feet north of McMahon) R-04-28 MTB
c. Right-in/right-out access shall be allowed at:	1) <i>Right-in only</i> approximately the midpoint between Westside Boulevard and Arroyo Road R-09-01 TCC	
	2) Approximately half-way between Black Arroyo Boulevard and Arroyo Road (Healthy Way), <i>right-in only</i> (City of Rio Rancho correspondence on June 20, 2008 - three-party agreement with City of Albuquerque and NMDOT)	
	3) Black Arroyo Boulevard (in each direction)	
	4) Approximately 520 feet north of the Cabezon Blvd/Southern Blvd intersection R-06-02 TCC	
	5) A right-in only access on the west side of Unser Blvd. approximately 650 feet south of Westside Boulevard. R-09-03 TCC	
d. Until traffic safety and capacity considerations warrant their closure, local access shall be allowed at:	1) Essex Drive (right-in/right-out access to the west, and left-in access)	
	2) Fordham Drive (right-in/right-out access to the east)	
	3) Alder Drive (right-in/right out access to the west)	
6. Southern Boulevard to US 550	a. It is strongly encouraged that this access control policy be applied to Unser between Southern and US550 to assure that the function and capacity of the roadway are protected in the future.	
	b. Full-access intersections at:	1) Zaragosa Rd R-05-01 MTB

Uptown Loop Road

M. Uptown Loop Road

Access shall be as defined in the Uptown Sector Plan.

Westside Boulevard

N. Westside Boulevard (R-2000-11)

Access shall be provided for full intersections at approximate one-half mile intervals and for T intersections and right-in/right-out driveways at approximate one-quarter mile intervals, except within the potential village center area of Unit 16. Here more frequent access is allowed provided that driveways are not located closer than approximately 400 feet from adjacent access points.

	Full Intersection at:	1) Approximately 1,200 feet west of Unser Boulevard. R-09-03 TCC
	Partial Access at:	1) A right-in/right-out & left-in access on the south side of Westside Blvd approximately 700 feet west of Unser Boulevard. R-09-03 TCC



MEMORANDUM

To: Mikaela Renz-Whitmore, City of Albuquerque Planning Department
From: Colin Burgett, Magnus Barber, Rick Chellman and Jeremy Nelson
Date: August 7, 2012
Subject: Volcano Heights Multi-modal Transportation Assessment

This memorandum describes the traffic forecast and circulation assessment conducted by Nelson\Nygaard of the proposed roadway network described in the Working Draft of the *Volcano Heights Sector Development Plan* (VHSDP) as of April 2012.

Purpose of the Sector Plan

The purpose of the VHSDP is to leverage the opportunity to create a major employment and activity center on the City's West Side in order to address the imbalance of jobs on the East Side and primarily housing on the West Side and relieve some congestion on river crossings caused by one-way commutes over time.

The Plan proposes a high-density, mixed-use development pattern that can encourage pedestrian, bicycle, and transit use for local trips without adversely impacting auto travel on the region's most important arterials – Paseo del Norte and Unser Boulevard, both of which are access-controlled by policy. This proposal has elicited several concerns by stakeholders and agency staff, including:

- Local impact of such intense development on surrounding neighborhoods and roadways;
- Regional impact of this development on the broader transportation network; and
- Potential effect of additional intersections on limited-access roadways.

Purpose of this Report

In order to assess the key concerns summarized above, Nelson\Nygaard was engaged by the Sector Plan consultant, Gateway Planning Group, as traffic engineering consultants to perform this traffic study.

The purpose of this assessment is to provide a conceptual, high-level analysis of the proposed roadway network. The analysis included conservative assumptions on various inputs in order to generate the worst-case scenario as a baseline for comparison between currently forecasted traffic volumes for 2035 and potential changes based on the proposed Plan.

- This study is not meant to provide the level of precision of a “near-term” Traffic Impact Analysis typically required to justify an access modification request for pending development applications on these limited-access roads.
- This report provides an “order-of-magnitude” trip generation comparison to assess the local impact of such intense development on surrounding neighborhoods and roadways.

- The circulation assessment focuses on potential operational concepts related to proposed quarter-mile spacing of intersections on the access-controlled Paseo del Norte and Unser Boulevard corridors within the Sector Plan boundary.

Report Overview

The traffic assessment is divided into the following three parts:

1. Traffic Forecast

Nelson\Nygaard prepared a forecast of motor vehicle traffic that would be generated by the land uses identified in the VHSDP and assessed the potential effect on the key regional roadways bordering the sector based on forecasted Year 2035 traffic volumes. The following steps were conducted:

- Review of VHSDP development assumptions including:
 - Land use buildout assumptions under the 2012 VHSDP and prior *Volcano Heights Conceptual Plan* prepared in 2006 that was used as the basis for growth assumptions put into the Mid-Region Council of Governments (MRCOG) traffic forecast to generate the 2035 Metropolitan Transportation Plan
 - Relevant VHSDP regulatory assumptions related to the planned design and long-term operation of the two key regional roadways that will provide access to the sector: Paseo Del Norte and Unser Boulevard
- Review of regional traffic forecast information relevant to site access focusing on:
 - Forecasted future traffic volumes on regional roadways that will serve the site, based on the MRCOG regional travel demand model forecast of Year 2035 traffic volumes
 - Confirmation of land use development assumptions for the Volcano Heights “sector” contained in the MRCOG Year 2035 traffic forecast, for purposes of assessing the potential change to Year 2035 traffic volumes resulting from land uses proposed in the 2012 VHSDP
- Preparation of preliminary Trip Generation forecast
 - Nelson\Nygaard prepared a preliminary forecast of Year 2035 trip generation for planning purposes, based on anticipated Year 2035 land uses under the proposed 2012 VHSDP
 - Nelson\Nygaard also provided a comparative trip generation for the site, based on the assumed Year 2035 land uses that are incorporated into the MRCOG Year 2035 model, for purposes of assessing the “net change” to Year 2035 traffic that would result from the VHSDP

2. Circulation Assessment

Incorporating the trip generation evaluation described in Part 1, Nelson\Nygaard provided input on the proposed street network as described in Part 2 of this report, focusing on review of:

- 2012 VHSDP site access characteristics focusing on proposed:
 - Circulation to and from adjacent sectors outside the boundaries of the VHSDP
 - Multi-modal access to the regional arterial and transit network
 - Site access capacity relative to trip generation forecast
- Proposed VHSDP internal street plan elements related to:
 - Block size and distance(s) between intersections
 - Network connectivity

- Right-of-way widths (streets, sidewalks, and bicycle/pedestrian trails)
- Internal capacity relative to trip generation forecast

3. Relevant Case Studies

Based on the forecasted Year 2035 volumes on the two key regional arterials that will provide access to the sector, Paseo Del Norte and Unser Boulevard, Section 3 describes the general design and operational characteristics of several arterial streets in other cities for comparative purposes. In particular, the case studies provide examples of arterial streets that operate acceptably, carrying similar volumes of traffic as forecasted on Paseo Del Norte and Unser Boulevard, and include desired characteristics identified in the Sector Plan related to:

- Intersection spacing
- Narrower right-of-way configurations
- Multi-modal circulation elements

Figure 1-1. Local Context: Volcano Heights Sector & Adjacent Planning Areas



Source: City of Albuquerque Planning Department, Summary Sheet for *Volcano Heights Sector Development Plan*, March 27, 2012

Figure 1-2. Regional Context: Key Circulation Routes

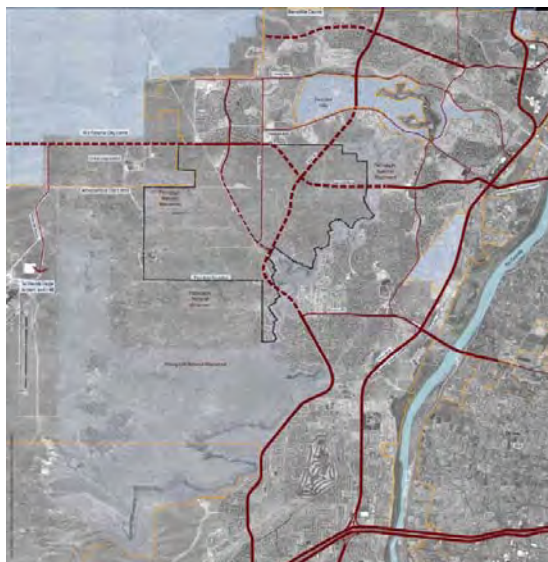

Source: City of Albuquerque, *Volcano Heights Planning Study Report*, March 15, 2005

1. TRAFFIC ASSESSMENT

This section describes the steps taken to prepare a preliminary forecast of future traffic volumes that would be generated by the proposed land uses described in the VHSDP and an assessment of the resulting effect on the key regional circulation routes the provide access to the site.

VHSDP Development Assumptions

The traffic study did not include a comparison of existing zoning – Residential Developing (RD) Area Zone. RD is intended primarily as a holding zone until an area develops, allowing only single-family and townhouse development without an adopted sector development plan. The existing zoning, if unchanged, would result in exclusively residential development, most likely predominantly single-family houses with some townhouse development along major corridors. This development could result in up to 12,000 dwelling units, which would add another “bedroom community” on Albuquerque’s West Side. The table below is included for informational purposes only to facilitate a high-level comparison.

In general, the amount of traffic generated based on the development scenarios below would be less than either the 2006 Conceptual Plan or the 2012 proposed Sector Plan, but it also would not include any services or employment for the surrounding area, which is a stated City policy for the Volcano Heights area. There would also be no reduction of vehicle trips from mixed-use scenarios or from compact development that can support transit service and encourage transit ridership. As shown on Figure 1-3, development of 2,848 single-family dwelling units, a development scenario that would be allowable under existing zoning, would generate over 26,000 daily vehicle trips (approximately 9.5 daily vehicle trips per dwelling unit) on adjacent roads, and approximately 2,800 vehicle trips during the PM peak hour (approximately one peak hour vehicle trip per unit).

Figure 1-3. Single-family Dwelling Units (DU) and Traffic Generation

Land Use	No. Units	Trip Generation Rate (see note 1)				Total Trips		
		Daily	AM Peak	PM Peak	Units	Daily	AM Peak	PM Peak
Scenario A: Residential Development with 1/2 Acre Lot Sizes (see note 2)								
Detached	924 (units)	9.57	0.77	1.02	/unit	8,843	711	942
Transit Trips (see note 5)		0%	1%	1%		27	7	7
Walk & Bicycle Trips (see note 6)		0%	0%	0%		0	0	0
Total Vehicle Trips Generated						8,821	704	935
Internal Vehicle Trips		0%	0%	0%		0	0	0
External Vehicle Trips (see note 6)		100%	100%	100%		8,821	704	935
Scenario B: Residential Development with 1/4 Acre Lot Sizes (see note 3)								
Detached	1,681 (units)	9.57	0.77	1.02	/unit	16,087	1,294	1,715
Transit Trips (see note 5)		0%	2%	2%		78	26	26
Walk & Bicycle Trips (see note 6)		0%	0%	0%		0	0	0
Total Vehicle Trips Generated						16,010	1,268	1,689
Internal Vehicle Trips		0%	0%	0%		0	0	0
External Vehicle Trips (see note 6)		100%	100%	100%		16,010	1,268	1,689
Scenario C: Residential Development with 1/8 Acre Lot Sizes (see note 4)								
Detached	2,848 (units)	9.57	0.77	1.02	/unit	27,255	2,193	2,905
Transit Trips (see note 5)		1%	4%	3%		263	88	88
Walk & Bicycle Trips (see note 6)		3%	2%	1%		818	33	29
Total Vehicle Trips Generated						26,175	2,072	2,788
Internal Vehicle Trips		0%	0%	0%		0	0	0
External Vehicle Trips (see note 6)		100%	100%	100%		26,175	2,072	2,788

Year 2035 Land Uses with Sector Plan

Unlike the existing zoning, the land use strategy in the 2012 VHSDP allows mixed-use development, with residences and services within walking or biking distance of each other. This development is intended to serve new residents, nearby residents, as well as regional markets. VHSDP development assumptions for Year 2035 were based on the allowable land uses, as described in the VHSDP, and a market assessment of future demand for office and retail space in the area within the specified timeframe. Based on that assessment, City Planning staff provided the following forecast of Year 2035 land uses:

- 2 million square feet of commercial space including:
 - 1.2 million square feet of office space
 - 800,000 square feet of retail space (mix of regional-serving, local-serving and specialty retail uses)
- 4,769 residential dwelling units consisting of:
 - 4,114 multi-family dwellings
 - 364 single-family detached dwellings
 - 291 single-family attached (rowhouse, townhouse, or duplex) dwellings

Figure 1-4 shows the proposed land use designations described in the VHSDP. Based on the distribution of allowable land uses within the sector, Gateway Planning provided a detailed spreadsheet describing the potential allocation of development on a block-by-block basis. Figure 1-5 shows a sketch version of the block layout utilized for conceptual forecasting purposes only.

Planned Arterial Street Network

The planned regional roadway network includes three key facilities that will provide direct access to Volcano Heights:

- Paseo del Norte, designated as a 6-lane limited-access facility with half-mile spacing between signalized intersections, including grade-separated crossings at several locations outside the sector and at-grade intersections planned within the study area,
- Unser Boulevard, designated as a 4-lane limited-access facility with half-mile spacing between signalized intersections and at-grade intersections planned within the study area, and
- Universe Boulevard, designated as a 4-lane major arterial.

Figure 1-4. VHS DP Proposed Character Zones & Street Types

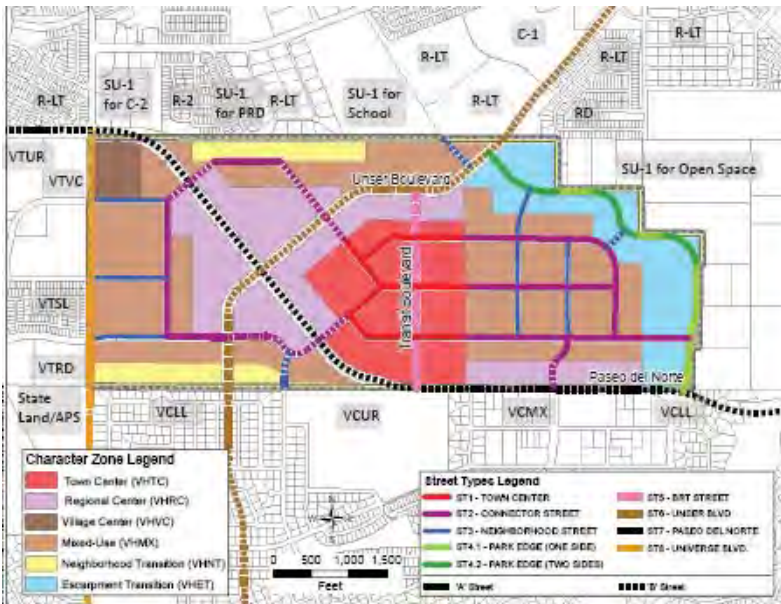

Source: City of Albuquerque Planning Department, Summary Sheet for *Volcano Heights Sector Development Plan*, March 27, 2012

Figure 1-5. Conceptual Illustration of Possible Internal Streets & Block Layout

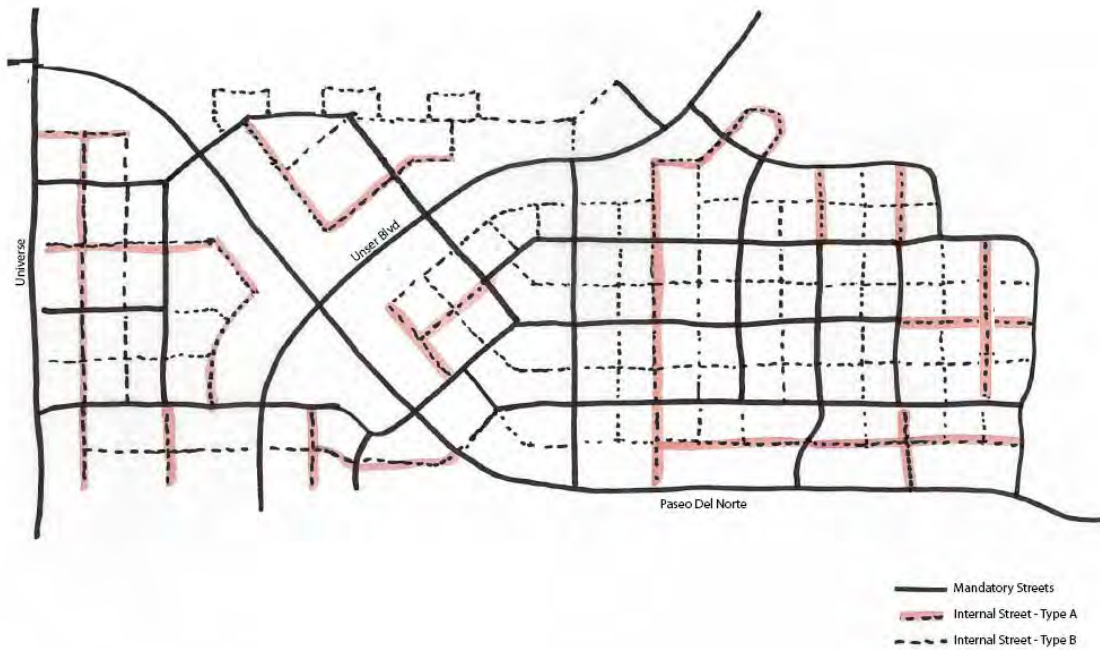

Source: Gateway Planning, Draft *Volcano Heights Internal Streets*, April 30, 2012 (For traffic modeling purposes only)

Regional Travel Model Assumptions

Future traffic volumes on the regional roadway network are forecasted by the MRCOG regional travel demand model.

Figure 1-6. Regional Travel Model Network & Conceptual VH Road Network

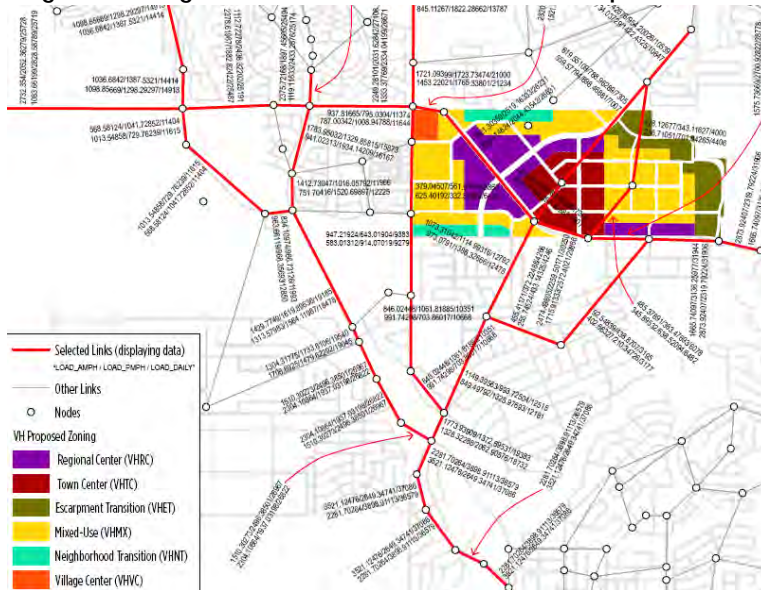

Year 2035 Land Uses without Sector Plan (Baseline Development Scenario)

The MRCOG model forecast of Year 2035 traffic volumes generated by development of the Volcano Heights sector is based on the proposed mix of land uses identified in the 2006 Volcano Heights Conceptual Plan. The anticipated level of development by Year 2035 would consist of 1,650 dwelling units and commercial development providing 9,500 jobs, representing approximately 3 million square feet of commercial development.

The Conceptual Plan envisioned a similar “village” core as the Sector Plan, but with several key differences:

- Outside of the “village” core area, the Conceptual Plan designated most of the site for office development, with a much smaller area designated for potential residential development.
 - The Conceptual Plan would allow over 1 million square feet of additional office space, compared to the Sector Plan, primarily with “office park” developments outside of the “village” core
- As a result, the number of residential units allowed under the Conceptual Plan is much lower than the Sector Plan
 - Under the Conceptual Plan, just 1,650 residential dwelling units are anticipated by Year 2035

- Under the proposed Sector Plan, up to 4,800 residential dwelling units are anticipated by Year 2035
- Both plans would allow similar levels of retail development within the “village core” area. Therefore, since the Sector Plan forecast of Year 2035 commercial development is based on anticipated retail demand in the area, there is no difference anticipated in the mix of retail uses under Year 2035 conditions
- A key difference between the two plans is the proposed street layout, identified in the Sector Plan, which would extend the “village” grid concept to cover most of the VH sector, with smaller block sizes, narrower streets, and an increased emphasis on facilitating local connections at multiple intersections, with dispersal of traffic throughout the grid network. The mix of uses in close proximity is also intended to facilitate additional pedestrian and bicycle trips and help support transit service and encourage transit use.

Figure 1-7 shows the forecasted Year 2035 daily traffic volumes, including vehicle trips generated by VH Conceptual Plan land uses, on the regional roads providing access to the area. Peak hour traffic volumes are forecasted to be roughly 10 percent of daily traffic volumes.

Figure 1-7. Forecasted Year 2035 Traffic Volumes (with Baseline Land Uses from VH Conceptual Plan)

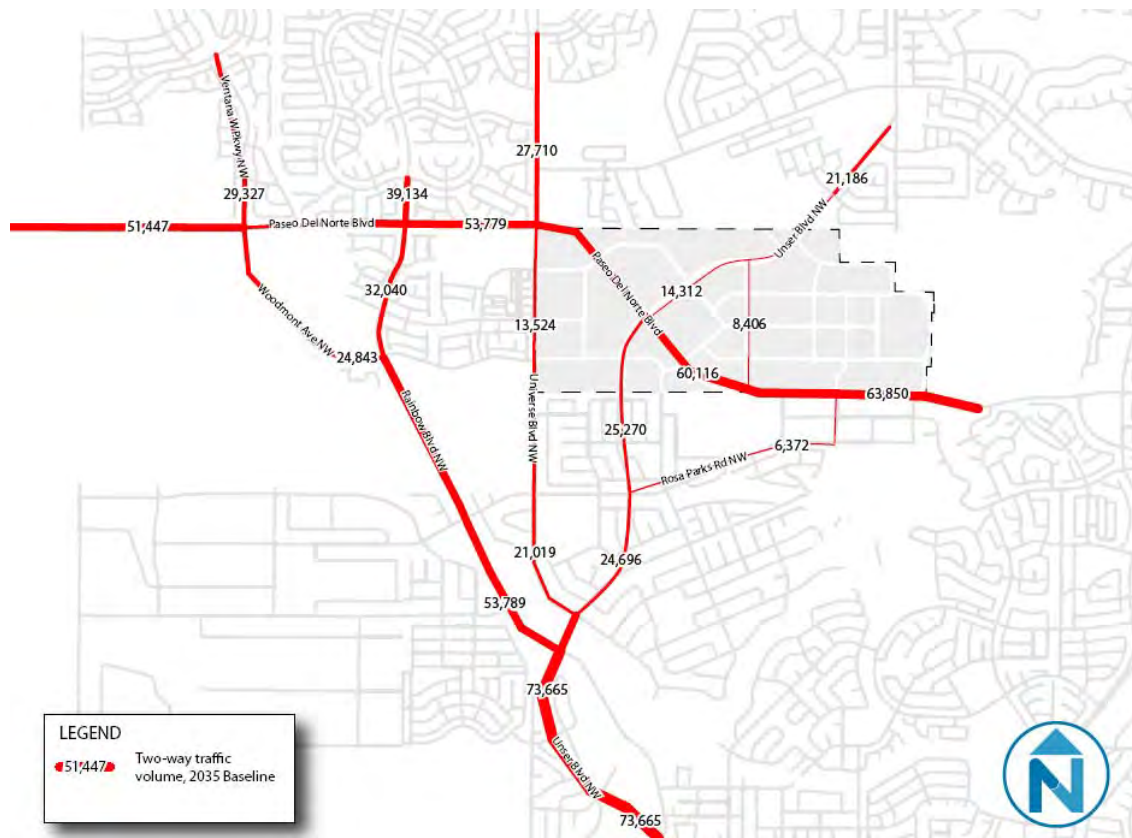

Source: Mid-Region Council of Governments, Year 2035 Daily Traffic Volume Forecast

As shown on Figure 1-7, forecasted daily volumes on the key regional roadways providing access to the Volcano Heights sector are as follows:

- East/West Circulation
 - Paseo del Norte: 60,000 daily vehicles within the VH core area
- North/South Circulation
 - Unser Boulevard: 14,000 daily vehicles within the VH core area
 - Universe Boulevard: 13,000 daily vehicles bordering the VH sector
 - Rainbow Boulevard, west of the VH sector: 50,000 daily vehicles by-passing the VH sector
 - South of the study area, north/south circulation will be funneled onto just one north/south connection to be provided by the lower segment of Unser Boulevard, projected to carry over 70,000 daily vehicles

Future Traffic Capacity

Planned roadway capacity and forecasted Year 2035 traffic volumes are summarized below in Figure 1-8. As shown, a significant amount of excess north-south capacity will be provided on both Unser and Universe Boulevards, while Paseo del Norte will operate at full capacity.

Figure 1-8 Future Traffic Volumes & Planned Capacity on Major Arterials within Volcano Heights

Planned Year 2035 Roadway Network Capacity & Forecasted Traffic Volumes								
Regional Road	Through Lanes (Planned)		Intersection Turn Lanes (Planned)		Approximate Capacity* (Planned)		2035 Traffic Volume Forecast ***	
	Total Lanes	Lanes per Direction	Left-turn lanes at signalized intersections	# of right-turn lanes at intersections	Peak Hour	Daily **	Daily	# of Through Lanes Needed to Accommodate Forecasted Volume
Paseo del Norte	6	3	2	1	6,000	60,000	60,116	6
Unser Blvd	4	2	2	1	4,000	40,000	14,312	2
Universe Blvd	4	2	1-2	0-1	3,500	35,000	13,524	2

*Assumes a balanced signal timing plan, with equal allocation of time to all approaches at major intersections.
 **Daily capacity is typically estimated based on peak-hour capacity multiplied by ten.
 ***Forecasted traffic volume within the Volcano Heights core area based on Conceptual Plan land uses and street network.

Implications for Volcano Heights Roadway Network

Excess capacity on Unser and Universe Boulevards provides an opportunity to potentially consider narrower right-of-way allocations on those two facilities within and bordering the VH site. Given the grid street pattern, and potential traffic constraints on Paseo del Norte, it seems likely that future VH residents will generally prefer Unser and/or Universe for local access, especially during peak travel periods. (Also see Section 3 of this report that provides several examples of street configurations from other cities carrying similar traffic volumes).

Spacing of Signalized Intersections

A key factor relevant to the proposed internal VH circulation network relates to the desired spacing of signalized intersections on major arterials, particularly on Paseo del Norte. In walkable, mixed-use areas, typical block sizes of 300 to 400 feet allow for direct pedestrian travel between destinations. Where half-mile (2,620 feet) or quarter-mile (1,320 feet) distances are provided on major arterials, walking distances of over a half-mile can be required between land uses on opposite sides of the same street.

However, where traffic volumes are high relative to capacity, as will be the case on Paseo del Norte, it will be difficult to achieve 2-way synchronization of traffic signals at the desired regional travel speeds of 40 to 50 miles per hour (mph). Figure 1-9 provides examples of 2-way signal coordination options with varying travel speeds and varying distances between signalized intersections (half-mile, quarter-mile, and smaller).

Figure 1-9 Travel Speed & Intersection Spacing Considerations on Major Arterials

General Distance between Signalized Intersections for 2-way Signal Synchronization at Various Travel Speeds					
Travel Speed (mph)	2-way synchronization options				Notes
	Distance between signalized intersections	Signal off-set for 2-way coordination (seconds)	Signal cycle length (seconds)*	Travel Time on Paseo del Norte through VH	
50	Half-mile	36	72	2.1	<i>Cycle lengths of less than 90 seconds likely infeasible at higher speeds with wide right-of-way & turn phases.</i>
45	Half-mile	40	80	2.3	
40	Half-mile	45	90	2.6	<i>Cycle length of 90 to 120 seconds likely required on Paseo del Norte to accommodate 120-ft pedestrian crossing distances and left-turn phases.</i>
36	Half-mile	50	100	2.9	
30	Half-mile	60	120	3.5	
30	Quarter-mile	30	60	3.5	<i>Cycle length of 60 to 90 seconds may be feasible with reduced travel speeds and shorter pedestrian crossing distances.</i>
25	Quarter-mile	36	72	4.2	
20	Quarter-mile	45	90	5.2	
18	660 ft	25	50	5.8	
15	660 ft	30	60	7.0	
10	400 ft	30	60	10.5	<i>Ideal travel speed for bicycle circulation.</i>

*Assumes a balanced signal timing plan, with equal allocation of time to all approaches at major intersections.
 ** Length of Paseo del Norte = 1.75 miles through Volcano Heights sector.

Sector Plan Traffic Generation

The steps undertaken to provide a preliminary vehicle trip forecast for proposed Year 2035 land uses under the VHSDP are described below.

Step 1: ITE Baseline Trip Generation

The baseline forecast of trips that would be generated by the Year 2035 land uses within the VHSDP boundaries was derived using trip generation rates for the key land use types provided by the Institute of Transportation Engineers (ITE) *Trip Generation Manual*, 8th edition.

ITE trip generation rates are based on studies of suburban locations, typically “single-use” developments. Such developments typically are located in areas with minimal public transit service and minimal provisions for pedestrian and bicycle circulation. Land uses selected for observation also generally provide separate, free parking facilities for each land use, and nearly all trips to and from such sites are made via private motor vehicle.

ITE chose to collect data at single-use suburban sites precisely to provide a “baseline” forecast of traffic generation that should be adjusted based on local characteristics and site-specific factors, such as:

- Rates of transit ridership and service
- Provisions for pedestrian and bicycle circulation
- Density and mix of land uses, particularly relevant to mixed-use developments, as envisioned in the VHSDP, in which a portion of trips will occur internally, between the various land uses within the sector

Since the baseline trip generation rates for individual land uses are based on data collected at low density development with separated land uses and minimal transit, walking, or biking, ITE cautions that trip generation analysis using ITE rates as a “baseline” must take into account land use and transportation alternatives from the local context in order to be accurate.

The methodology for applying site-specific trip generation factors based on the proposed mix of land uses and proposed street network configuration is described in Steps 2, 3, and 4.

Step 2: Baseline Trip Adjustment to Avoid Double-counting of Internal Trips

The model was adjusted to account for internal trips to/from retail uses that would otherwise be double-counted, based on ITE internal trip capture data for retail uses (to/from office, residential and other retail uses) in mixed-use developments.

Step 3: Baseline Trip Adjustment to Account for Retail Pass-by Trips

A significant portion of retail trips are “pass-by” trips (e.g. stopping at a store on your way home). In this example, the store itself did not generate the trip but rather benefits from its location on your route home. Pass-by trip rates are often between 20 and 50 percent of retail trips, generally higher for smaller retail establishments.

This forecast applied a PM Peak Hour pass-by rate of 25 percent for PM Peak derived from ITE logarithm for Shopping Centers applied to the anticipated size of regional retail sites within VH (determined at the block level). The daily pass-by rate was estimated conservatively at 15 percent.

Step 4: Bicycle & Walking Trips

The proposed development will have a relatively dense street network, a mix of land uses in close proximity, and street designs that incorporate facilities for bicycle, pedestrian and transit users. Residents and employees living and working in Volcano Heights will have some transportation choice; different modes may be more convenient at different times, depending on the trip.

Since the ITE average trip generation rates are based on observations made at single-use sites, the ITE average rates will not accurately predict the level of trip generation that would result from the proposed mix of uses at Volcano Heights. Therefore, consistent with the ITE recommended practice, the ITE average rates were adjusted based on local conditions, including the proposed mix of land use types.

To estimate the effect of the proposed mix-use development pattern on trip generation, Nelson\Nygaard used the URBEMIS methodology. URBEMIS is a program developed for the California Air Resources Board to calculate vehicle trips and resulting emissions resulting from new development.

URBEMIS was developed to more accurately reflect the level of vehicle trip generation resulting from new development by providing formulas based on specific site characteristics. The URBEMIS methodology is designed to offer a useful comparison of the difference in trip generation that can be expected when locating high density development in mixed-use, high-density areas with alternative transportation modes available and/or transportation demand management programs in place.

URBEMIS calculates trip generation rates starting with the ITE average trip generation rates as a base. The URBEMIS method employs standard methodologies but provides the opportunity to adjust ITE average rates to quantify the impact of a development's location, physical characteristics, and any demand management programs. In this way, it provides an opportunity to fairly evaluate developments that minimize their transportation impact, for example, through locating close to transit or providing high densities and a mix of uses.

Area Inputs

In addition to requiring the transportation modeler to input the basic land use components of the proposed project (i.e. the number of square feet of each land use), URBEMIS also factors in other area-specific characteristics to determine accurate trip rates. The number of trips generated by a development depends not only on the characteristics of the project itself, but also on the nature of the surrounding area. For example, neighborhood characteristics such as a good balance of housing and jobs, the presence of frequent transit service, and a highly-connected, walkable street network are strongly associated with lower vehicle trip rates. High-density housing added to an existing central city neighborhood, where many shops, services, and transit already exist, will normally generate fewer trips than the same housing located close to a freeway interchange and surrounded by only low-density housing subdivisions. For this reason, URBEMIS requires data about the area within approximately a half-mile radius from the center of the project, or for the entire project area, whichever is larger. Figure 1-10 shows the key project area characteristics applicable to the URBEMIS methodology.

Figure 1-10 Area Characteristics Input to URBEMIS Model

Factors
Number of housing units within ½ mile radius
Number of jobs located within ½ mile radius
Local serving retail within ½ mile radius
Transit service
Intersection density within ½ mile radius*
Sidewalk completeness within ½ mile radius
Bike lane completeness within ½ mile radius

Note: * Calculated from proposed street network, based on the number line segment terminations, or each "valence." Intersections have a valence of 3 or higher: a valence of 3 is a "T" intersection, 4 is a four-way intersection, etc.

It is important to note that the above characteristics do not incorporate any transportation demand management (TDM) measures, such as specific programs, incentives, or strategies to reduce trip generation. Rather, they are based entirely on the mix and density of land uses and the proposed design of the road network.

Step 5: Transit Trip Forecast

For planning purposes, a preliminary "back-of-the-envelope" estimate of potential transit ridership was incorporated into this forecast, which assumed a relatively modest level of transit ridership, 5% of home to work trips for both residential and non-residential land uses, plus daily "non-work" transit trips estimated at 50% of daily work trips by transit. Higher levels of transit ridership are ultimately feasible depending on the ultimate level of transit service and transit incentives.

Step 6: Vehicle Trip Forecast

The resulting vehicle trip forecast is shown on Figure 1-11 for Volcano Heights, while a comparative trip generation forecast based on Conceptual Plan land uses, based on the same methodology, is shown on Figure 1-12.

Volcano Heights Multi-modal Transportation Assessment
City of Albuquerque Planning Department – August 7, 2012

Figure 1-11 Preliminary Trip Generation Forecast: Volcano Heights Sector Development Plan (Year 2035)

Land Use	No. Units	Trip Generation Rate (see note 1)				Total Trips		
		Daily	AM Peak	PM Peak	Units	Daily	AM Peak	PM Peak
Residential								
Detached	364 (units)	9.57	0.77	1.02	/unit	3,483	280	504
Attached	291 (units)	5.81	0.44	0.52	/unit	1,691	128	151
Multifamily	4,114 (units)	6.65	0.51	0.62	/unit	27,360	2,098	2,551
Hotel	53,600 (ft2)	8.92	0.64	0.74	/occupied room	797	57	66
Office	1,180,135 (ft2)	11.01	1.55	1.49	/1,000 ft2	12,993	1,829	1,758
Retail								
Regional Retail	326,700 (ft2)	42.94	1.95	7.70	/1,000 ft2	14,028	638	2,515
Specialty Retail	322,198 (ft2)	44.32	6.84	5.02	/1,000 ft2	14,280	2,204	1,617
Local Retail	170,600 (ft2)	42.94	3.72	12.92	/1,000 ft2	7,326	635	2,205
<i>Internal Trip Adjustment (see note 2)</i>		-19%	-15%	-20%		-15,679	-1,181	-2,218
<i>Retail Pass-by Trips (see note 3)</i>		-15%	-15%	-25%		-5,345	-522	-1,584
Base Trip Subtotal (VH Sector Development Plan)						60,935	6,168	7,565
<i>Walk & Bicycle Trips (see note 4)</i>		15%	14%	20%		9,070	836	1,550
<i>Transit Trips (see note 5)</i>		3%	5%	4%		2,000	300	300
Total Vehicle Trips Generated						49,865	5,032	5,715
<i>Internal Vehicle Trips (see note 6)</i>		13%	7%	11%		6,509	330	653
<i>External Vehicle Trips (see note 7)</i>		87%	93%	89%		43,356	4,702	5,062
Notes:								
(1) Base trip rates from ITE Trip Generation, 8th Edition. Peak hour trips rates shown for Regional Retail and Local Retail based on fitted curve logarithm applied at block level.								
(2) Adjustment to account for internal trips to/from retail uses that would otherwise be double-counted, based on ITE internal trip capture data for retail uses (to/from office, residential and other retail uses) in mixed-use developments.								
(3) Pass-by rate of 25 percent for PM Peak derived from ITE logarithm for Shopping Centers (while local and specialty retail uses often have higher pass-by rates). Daily pass-by rate conservatively estimated at 15 percent.								
(4) Mode shift for internal trips based on proposed density, mix of uses, block layout, bicycle and pedestrian facilities								
(5) Based on preliminary "back-of-the-envelope" estimate of potential transit ridership. Assumed 5% of home to work trips for both residential and non-residential land uses would occur via transit plus estimated "non-work" transit trips at 50% of								
(6) Total Vehicle Trips derived by subtracting walk & bicycle trips (see note 4) and transit trips (see note 5) from Base Trip Subtotal.								
(7) Derived from estimated internal trips (see note 2), subtracting internal walk & bicycle trips (see note 4) and internal transit trips (estimated at 5% of transit ridership).								
(8) Net vehicle trips derived by subtracting internal vehicle trips (see note 6) from total vehicle trips generated.								

Volcano Heights Multi-modal Transportation Assessment
City of Albuquerque Planning Department – August 7, 2012

Figure 1-12 Baseline Trip Generation Forecast: Volcano Heights *Conceptual Plan* Land Uses (Year 2035)

Land Use	No. Units	Trip Generation Rate (see note 1)				Total Trips		
		Daily	AM Peak	PM Peak	Units	Daily	AM Peak	PM Peak
Residential								
Detached	490 (units)	9.57	0.77	1.02	/unit	4,689	377	500
Attached	0 (units)	5.81	0.44	0.52	/unit	0	0	0
Multifamily	1,160 (units)	6.65	0.51	0.62	/unit	7,714	592	719
Office Park	1,900,000 (ft2)	11.42	1.72	1.50	/occupied room	21,698	3,268	2,850
Office (Town	280,502 (ft2)	11.01	1.55	1.49	/1,000 ft2	3,088	435	418
Retail (Town								
Regional Retail	326,700 (ft2)	42.94	1.95	7.70	/1,000 ft2	14,028	638	2,515
Specialty Retail	322,198 (ft2)	44.32	6.84	5.02	/1,000 ft2	14,280	2,204	1,617
Local Retail	170,600 (ft2)	42.94	3.72	12.92	/1,000 ft2	7,326	635	2,205
<i>Internal Trip Adjustment (see note</i>		-22%	-15%	-19%		-15,679	-771	-2,010
<i>Retail Pass-by Trips (see note 3)</i>		-15%	-15%	-25%		-5,345	-522	-1,584
Base Trip Subtotal (2006 VH Conceptual Plan Land Uses)						51,800	6,856	7,230
<i>Walk & Bicycle Trips (see note 4)</i>		8%	9%	9%		4,271	592	652
<i>Transit Trips (see note 5)</i>		3%	3%	3%		1,500	225	225
Total Vehicle Trips Generated						46,028	6,039	6,353
<i>Internal Vehicle Trips (see note 6)</i>		25%	3%	21%		11,333	168	1,347
<i>External Vehicle Trips (see note 7)</i>		75%	97%	79%		34,696	5,871	5,007
Notes:								
(1) Base trip rates from ITE Trip Generation, 8th Edition. Peak hour trips rates shown for Regional Retail and Local Retail based on fitted curve logarithm applied at block level.								
(2) Adjustment to account for internal trips to/from retail uses that would otherwise be double-counted, based on ITE internal trip capture data for retail uses (to/from office, residential and other retail uses) in mixed-use developments.								
(3) Pass-by rate of 25 percent for PM Peak derived from ITE logarithm for Shopping Centers (while local and specialty retail uses often have higher pass-by rates). Daily pass-by rate conservatively estimated at 15 percent.								
(4) Mode shift for internal trips based on proposed density, mix of uses, block layout, bicycle and pedestrian facilities								
(5) Based on preliminary "back-of-the-envelope" estimate of potential transit ridership. Assumed 5% of home to work trips for both residential and non-residential land uses would occur via transit plus estimated "non-work" transit trips at 25% of								
(6) Total Vehicle Trips derived by subtracting walk & bicycle trips (see note 4) and transit trips (see note 5) from Base Trip Subtotal.								
(7) Derived from estimated internal trips (see note 2), subtracting internal walk & bicycle trips (see note 4) and internal transit trips (estimated at 5% of transit ridership).								
(8) Net vehicle trips derived by subtracting internal vehicle trips (see note 6) from total vehicle trips generated.								

Findings

Figure 1-13 provides a comparison of the net change in trips resulting from the Sector Plan as shown in Figure 1-11, in comparison with the Baseline scenario represented by the Conceptual Plan trip generation forecast summarized on Figure 1-12. Key findings for traffic operations purposes relate to peak hour traffic volumes. While the development proposed by the Sector Plan does increase external daily vehicle trips, it reduces the A.M. peak hour trips and does not significantly increase P.M. peak hour trips, when traffic congestion is anticipated to be the heaviest. The key findings are summarized as follows:

- No increase in peak hour traffic volumes compared to the baseline scenario,
- Increased bicycle and walking trips and fewer internal vehicle trips compared to the baseline scenario, and
- Adequate traffic grid and street cross sections to accommodate increased internal and external trips compared to the baseline scenario.

Figure 1-13 Daily & Peak Hour Trip Comparison

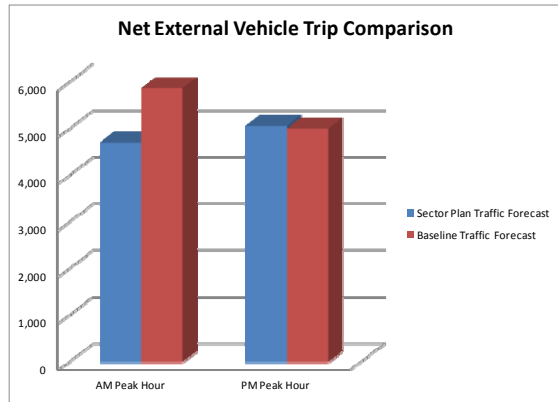
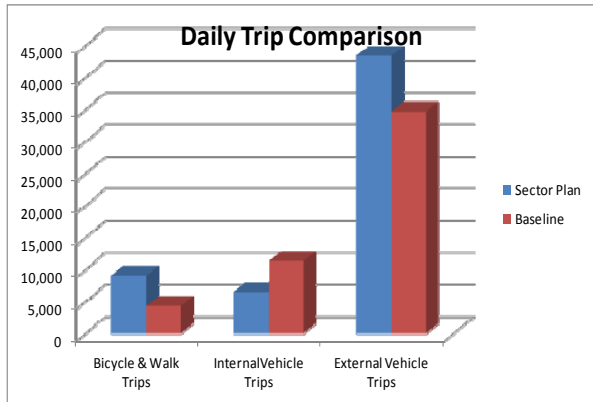

2. CIRCULATION ASSESSMENT

This section provides an assessment of the proposed street network focusing on traffic operations at planned and proposed signalized intersections.

Proposed Site Access

Arterial Access Concept

Figure 2-1 describes the primary access concept described in the 2012 VHSDP. As shown, signalized intersections on Paseo del Norte and Unser Boulevard would be provided at approximately quarter-mile intervals.

Figure 2-1 VHDSP Access Concept

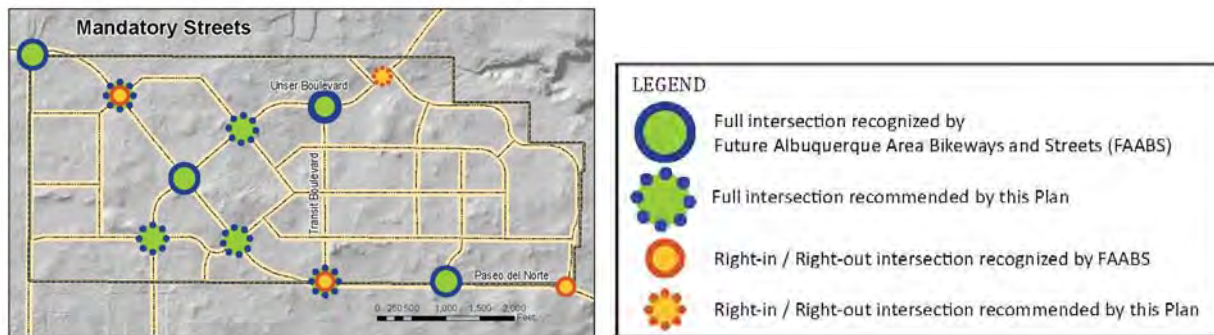

Figures 2-2 and 2-3 provide conceptual cross-section drawings showing the potential lane configurations on Paseo del Norte and Unser Boulevard, as well as potential proximity to adjacent land uses.

Figure 2-2 Paseo del Norte (Conceptual Cross Section)

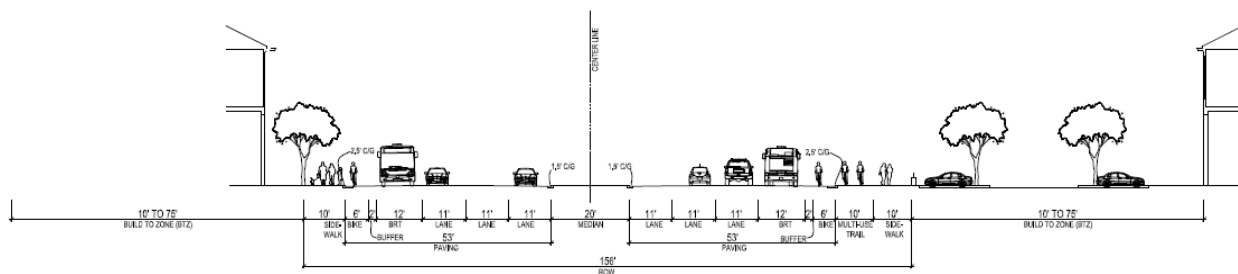
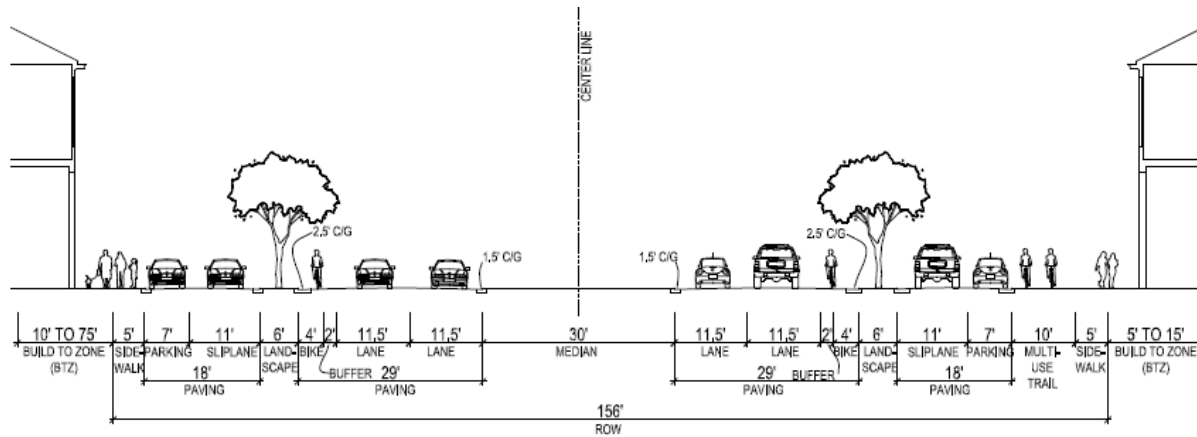

Figure 2-3 Unser Boulevard (Conceptual Cross Section)



Access to Internal Streets & Land Uses

Access to the internal street network and future land uses would primarily be provided by seven internal streets:

- Five internal “connector” streets would circulate between Paseo del Norte and Unser Boulevard, connecting with the internal street grid.
 - The connector streets would intersect the arterials at three proposed signalized intersection locations on Paseo del Norte and two proposed signalized intersection locations on Unser Boulevard.
 - The proposed “connector” streets between Paseo del Norte and Unser Boulevard are designated as NE Connector, NW Connector, SW Connector, SE Connector for purposes of this assessment.
 - The proposed “connector” street approximately one-fourth of a mile west of the eastern border of the sector is designated as East Connector for purposes of this assessment.
 - Figure 2-4 provides a conceptual illustration showing the potential lane and sidewalk configuration.
- **Park Edge Street** would circulate between Paseo del Norte and Unser Boulevard via “right-in/right-out” access to the arterials. Figure 2-6 provides a conceptual illustration of the proposed design options for the “Park Edge Street.”
- **Transit Boulevard** would circulate between Paseo del Norte and Unser Boulevard via “right-in/right-out” access to the arterials. Figure 2-5 provides a conceptual illustration showing the potential lane and sidewalk configuration.

Figure 2-4 Connector Streets (Conceptual Cross Section)

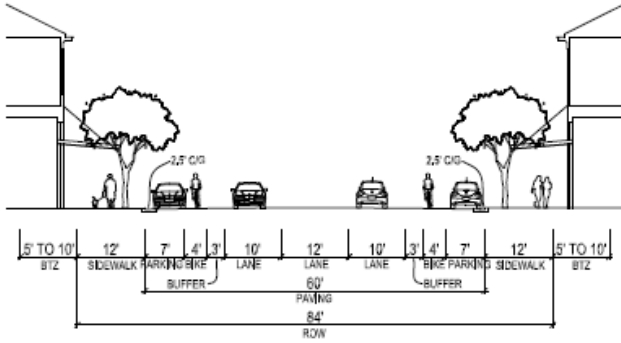

Figure 2-5 Transit Boulevard (Conceptual Cross Section)

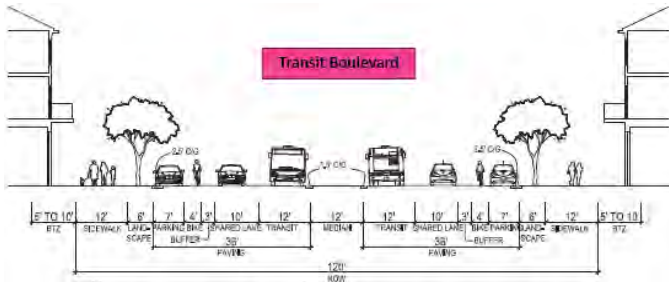
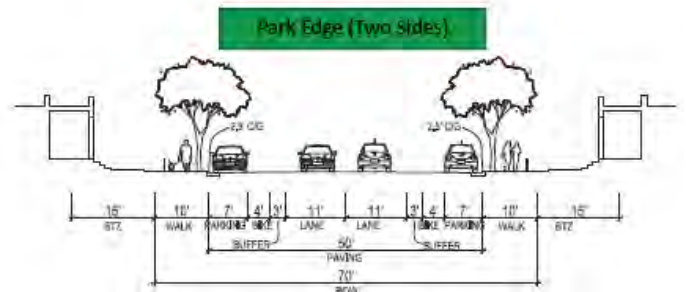
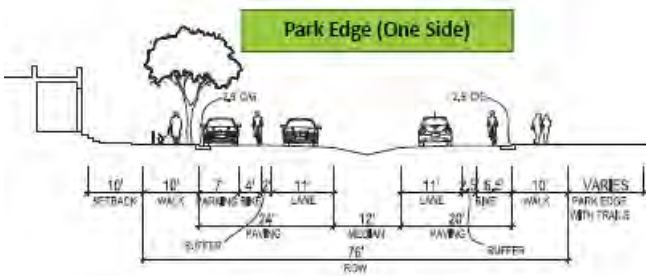

Figure 2-6 Park Edge Street (Conceptual Cross Sections)



Traffic Assessment

This section summarizes the potential effect of the three (3) proposed additional signalized intersections on Paseo del Norte (PDN) as described in the 2012 VHSDP.

Baseline Traffic Conditions

The segment of PDN that passes through the VH sector is approximately 1.75 miles long. Two signalized intersections are currently planned within the VH sector, while a third signalized intersection is located at the intersection of PDN.

Year 2035 Peak Hour Traffic Volumes

Peak-hour traffic volumes, based on the MRCOG model, would occur during the PM Peak Hour:

- 4,500 to 5,000 through vehicles on Paseo del Norte
- 1,500 to 2,000 through vehicles on Unser Boulevard

Baseline Level of Service Forecast

Nelson\Nygaard prepared level of service (LOS) reports for each of the proposed intersections based on forecast Year 2035 “through” volumes, and a conservative estimate of potential turning movements. (See Appendix A, Level of Service Reports).

- Average vehicle delay at arterial intersections on PDN is likely to average 40 to 50 seconds per vehicle, representing acceptable LOS D conditions.
- Average vehicle delay at non-arterial intersections on PDN is likely average 20 to 45 seconds, representing acceptable LOS C or D conditions.
- *Note: With a coordinated signal timing plan, and based on the traffic volumes forecasted for Year 2035, motorists would not be delayed at each intersection. Therefore, the “net” delay of passing through all three signalized intersection on Paseo del Norte would be less than the sum of the average delay at each individual intersection.*

Baseline Travel Time Forecast (Paseo del Norte)

For purposes of this analysis, the Year 2035 average net peak-hour travel time for east/west motorists traveling through the VH sector on Paseo del Norte is estimated to range from 150 to 200 seconds (2.5 to 3.3 minutes) based on an average travel speed of 42 miles per hour, which would allow for a 150-second travel time and would allow for 2-way signal coordination between Universe Boulevard and the planned East Connector (one-half mile east of Unser Boulevard).

- *With a coordinated 2-way signal coordination plan, delay to most east/west motorists could feasibly be limited to just one intersection, with up to 50 seconds of delay.*

Travel Speed Assumptions

The assumptions behind the baseline travel speed estimate are described in more detail below.

Based on the planned “freeway-like” characteristics of PDN, “baseline” conditions for traffic operations on PDN would be as follows:

- Travel speeds of 40 to 50 mph are anticipated during most time periods through 2035; however, delays at key intersections would likely reduce “net” travel time through the corridor, particularly during peak travel periods.
- Estimated net travel time through the corridor would range from approximately 120 to 240 seconds (2 to 4 minutes) based on the following:
 - Potential travel time through the corridor would be:
 - 120 seconds based on 52.5 mph travel speeds.
 - 140 seconds based on 45 mph travel speeds.
 - 150 seconds based on 42 mph travel speeds.
 - Average vehicle delay at the two arterial intersections during peak hours is likely to reach 40 to 50 seconds (average for all vehicles entering the intersection) at both intersections during Year 2035 conditions, based on the signal timing plan that would likely be needed to accommodate a significant volume of turning movements at each of those intersections.
 - Average vehicle at the third planned intersection, with East Connector, would be much less given the lower volume of turning movements at that intersection. With a signal plan that prioritizes east/west traffic at that intersection, average delay to east/west motorist of 10 to 20 seconds may be likely.
 - With a coordinated signal timing plan, potential delay to east/west through movements could be mitigated such that motorists would not be delayed at all three intersections. Rather, a portion of motorists would avoid delay at all three intersections, while many motorists would be delayed at one of the three intersections.
 - Given the width of Paseo del Norte, Unser Boulevard, and Universe Boulevard, 120-second signal cycles are likely to be necessary to accommodate Year 2035 traffic volumes and pedestrian crossings.
 - Based on that cycle length, a travel speed of 42 miles per hour would allow for 2-way signal coordination between Universe Boulevard and the planned East Connector signal location (one-half east of Unser Boulevard). This would result in a 150-second travel time for many motorists, while a portion of motorists would experience delay at signalized intersections, particularly where arterial streets intersect.
 - With a synchronized signal plan, delay to east/west motorist could potentially be reduced such that approximately half of east/west motorists could pass through all three intersections without delay, while the remaining half would likely be delayed at just one intersection. Based on this assumption, the total delay to east/west motorists passing through the 1.75 mile corridor would range from approximately 25 to 50 seconds.

Traffic Assessment: Key Assumptions

Based on the travel speed and initial signal timing assumptions described above, the proposed provision of three additional signalized intersections on Paseo del Norte was evaluated.

Traffic Volume & Turning Movement Assumptions

Nelson\Nygaard assessed the proposed arterial intersection configurations based on the Year 2035 traffic volume forecast described in the MRCOG model.

- **Through movements** at intersection on Paseo del Norte and Unser Boulevard were based directly on the model forecast. This provides a “conservative” assessment, since the actual volume of through movements should ultimately be reduced given the many turning movement options proposed within the VHSDP sector.
- **Turning movement volumes** were estimated based on the forecast of 5,000 external peak hour vehicle trips that would be generated by the VHSDP land uses, as well as a reasonable assumption of the ratio of turning movements to through movements to/from Paseo del Norte.
 - In addition, some assumptions regarding the potential use of the NE and SE Connector streets as “cut-through” routes were also incorporated into the turning movement estimates.

Traffic Signal Assumptions on Paseo Del Norte

Nelson\Nygaard developed a site-specific traffic operations model for the site using Synchro software. The following signal-timing assumptions were incorporated into the assessment:

- Based on the desired travel speeds on Paseo del Norte, the conceptual signal timing plan is based on signal off-sets of 22.5 seconds between signalized intersections at quarter-mile intervals, with a longer off-set of 30 seconds between Unser Boulevard and the proposed NW Connector Street intersection to the west, thus allowing a travel speed of approximately 42 miles per hour (mph).
- Since 22-second off-sets would not allow for 2-way signal coordination at all signalized intersection, a partial “split-phase” signal plan could accommodate the differing arrival times of eastbound and westbound traffic flows at some intersections.
 - *Note: The intersection with Unser Boulevard would have a slight off-set between eastbound and westbound traffic flows, since the eastbound traffic platoon, released by the upstream green-light for eastbound through movements at Universe Boulevard, would arrive approximately 16 seconds earlier than the westbound traffic platoon. This off-set can be accommodated by allowing eastbound left-turns to occur during the initial portion of the cycle (prior to the arrival of most westbound vehicles) while the westbound left-turns would be accommodated with a “lagging” left-turn phase.*

Based on this signal timing concept, the following two types of signal phasing options are included in the Synchro assessment:

- Signal Plan A would allocate 80 seconds to east/west traffic on Paseo del Norte, and 40 seconds to north/south traffic at the two planned intersections with Unser Boulevard and the East Connector Street
 - This signal plan will allow pedestrians to cross Paseo del Norte in a single phase, since 40 seconds would be the minimum pedestrian clearance time (including yellow and red-clearance periods) based on the proposed crossing distance of 120 feet.

- Signal Plan B would allocate 100 seconds to east/west traffic on Paseo del Norte, and 20 seconds to north/south traffic at three proposed signalized intersections, with Transit Boulevard, NE/NW Connector, and SE/SW Connector.
 - This signal plan would require pedestrians to cross Paseo del Norte in two separate crossing phases, since 40 seconds would be the minimum pedestrian clearance time (including yellow and red-clearance periods) for a single-phase based on the proposed crossing distance of 120 feet.
 - Therefore, with this configuration, pedestrians would cross one-half of Paseo del Norte during the north/south traffic phase, and then cross the second half during a separate 20-second pedestrian phase that that could be timed to occur concurrent with non-conflicting eastbound and westbound left-turn movements.
 - Left-turn treatments would potentially vary under Signal Plan B:
 - Side-street approaches: Given the limited time allocated to side-street approaches with this phase, it may be necessary to prohibit left-turn movements on some of the side-street approaches from the Connector Streets. No such left-turn prohibition would be necessary where “T” intersections are proposed, such as the proposed Transit Boulevard.
 - Left-turns from Paseo del Norte: Since eastbound and westbound traffic flows would not be “off-set” at Signal Plan B locations, this provides an opportunity for increased left-turn capacity, from Paseo del Norte to VH at these locations. This will be possible because left-turn movements will be able to occur concurrently with through movements, in one direction at a time, for 20 to 40 seconds during each signal cycle. During such periods, left-turns can effectively be made during gaps in opposing travel flows.

Figure 2-7 Signal Timing Concept: Planned Intersections



Figure 2-8 Signal Timing Concept: Proposed Additional VHSDP Intersections on Paseo del Norte

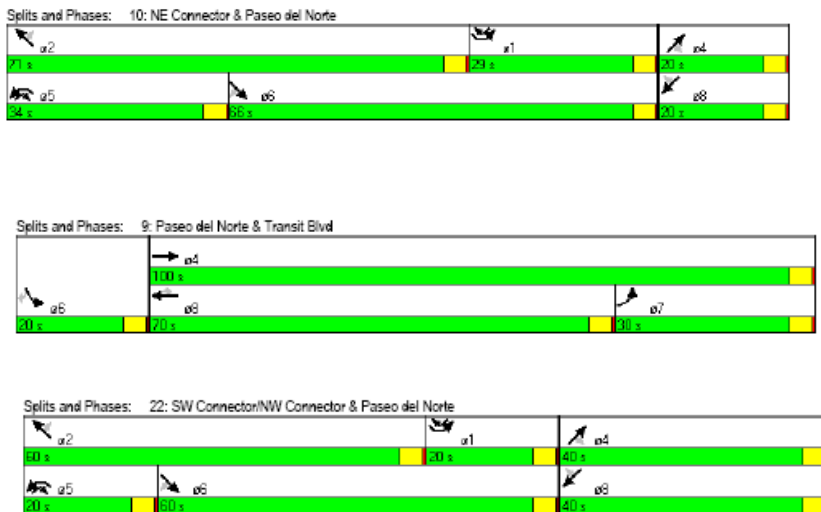

Traffic Assessment Findings

Based on the signal timing assumption described above, three of the proposed additional signalized intersections can be accommodated without significantly affecting traffic operations, and these intersections could ultimately significantly reduce delay at the adjacent intersections if the turning movements at those locations are reduced appropriately.

- Signal coordination on the 1.75-mile segment of Paseo del Norte within the VH sector can be provided with the additional intersections described in the VHSDP, with signal timing off-sets based on 42 mph travel speeds and 120-second signal cycles.
 - This signal coordination would synchronize the intersections of Paseo del Norte with Universe Boulevard and the East Connector (planned intersection one-half mile east of Unser Boulevard) in both directions with a 120-second off-set travel time between those 2 intersections, approximately 1.4 miles apart.
- Site access (inbound to VH from Paseo del Norte) would be enhanced with the additional intersections proposed, particularly if additional time is provided for left-turn movements entering the VH sector from Paseo del Norte at the proposed additional intersections.
 - This site access would reduce left-turn movements at the two currently planned intersections with Unser Boulevard and the East Connector Street.
 - Traffic operations at the intersection with Universe Boulevard is unlikely to be affected.
- Each signalized intersection would operate at an acceptable level of service (LOS) of D or better.

Net Effect on Travel Time

Based on this analysis, the estimated travel time range for east/west motorists traveling through the VH sector on Paseo del Norte is estimated to range from 150 to 230 seconds (2.5 to 3.3 minutes) based on an average travel speed of 42 miles per hour, which would allow for a 150-second travel time and would allow for 2-way signal coordination between Universe Boulevard and the planned East Connector (one-half mile east of Unser Boulevard).

- With a coordinated 2-way signal coordination plan, delay to most east/west motorists could feasibly be limited to just one intersection, with up to 50 seconds of delay.
- With the introduction of three additional intersections, a portion of east/west motorists would be delayed at a second intersection. Average delay at the three additional intersections would be approximately 30 seconds for the eastbound and westbound approaches.

Net Change Resulting from Three Additional Proposed Intersections

Based on this analysis:

- Net travel time would not change for most motorists.
- Some motorists could be delayed by up to 30 seconds at one of the additional three proposed intersections.
- Potential delays could be off-set by reductions in delay at the currently planned arterial intersections, particularly if left-turn volumes at the Unser Boulevard intersection are reduced by the greater dispersal of left-turn movements proposed by the VHSDP street network.

Proposed VHSDP Internal Street Network

The proposed internal circulation network would accommodate most trips to/from VH via the following seven internal streets:

- Four connector street segments with direct connections to both Paseo del Norte and Unser
- Transit Boulevard
- East Connector Street
- Park Edge

In addition to the seven primary access streets, additional internal circulation would be provided by “Town Center Streets,” as shown conceptually on Figure 2-9, as well as a network of local internal blocks with small block sizes.

Figure 2-9 Town Center Street (Conceptual Cross Section)

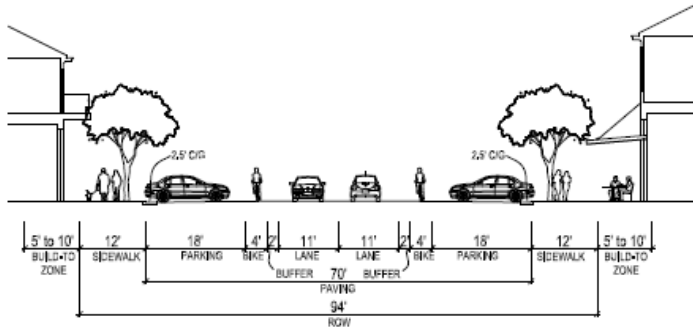
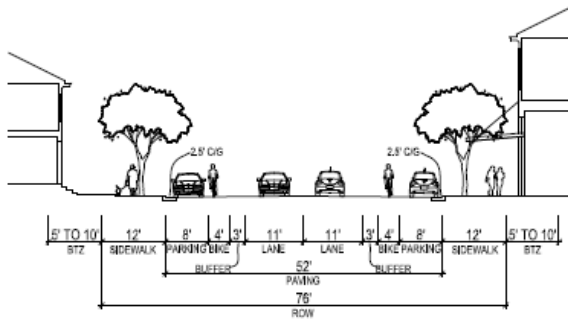

Figure 2-10 Neighborhood Street (Conceptual Cross Section)



Internal Traffic Capacity

Each of the seven primary internal streets, as well as three internal “Town Center Streets,” would have at least two motor vehicle lanes, bicycle lanes, and sidewalks, and most would accommodate on-street parking.

Therefore, each of the internal streets would provide the capacity to accommodate 13,000 or more daily vehicles on each internal street, via multiple entrance and exit paths. Based on the potential dispersal of traffic that would be allowed with multiple entrance and exit points, traffic volumes would be less than 10,000 vehicles per day on any single internal street.

Therefore:

- The proposed internal street network is more than adequate to accommodate the forecasted volume of traffic that be generated by the VHSDP land uses provided that such traffic is dispersed among multiple entrance and exit points (i.e. intersections with Paseo del Norte and/or Unser Boulevard, as proposed in the 2012 VHSDP).
- If the number of entrance and exit points were to be limited to just two or three entrance/exit point, then the volume on those few entrance/exit points would likely require additional travel lanes.

Potential Internal Circulation Constraints

Access to/from Regional Commercial Sites

As described in the 2012 VHSDP, much of the site would be developed with a grid of streets that would maximize internal circulation by providing multiple travel route options and reducing travel distances, particularly by providing small block sizes and a mix of land uses.

However, the portion of the VHSDP sector that borders the intersection of Paseo del Norte and Unser Boulevard would not be developed with the same pattern of internal blocks, due to proximity to the Paseo del Norte and Unser Boulevard, which require much longer spacing between intersections.

- Access to the regional commercial sites along Paseo del Norte and Unser Boulevard from elsewhere in the VH sector will require longer walking distances from within the site to reach a signalized intersection in order to cross these high-traffic volume, multi-lane streets, potentially discouraging those internal trips.
- Circulation between regional commercial sites will be limited, particularly for sites on opposite sides of Paseo del Norte.
- Additional direct multi-modal connections across Paseo del Norte and Unser Boulevard would be a significant safety improvement and benefit to uses on opposite sides of the roadway. As shown on Figure 2-11, such additional multi-modal connections could be provided via grade-separated crossings.

Figure 2-11 Grade-Separated Undercrossing (Example)



3. RELEVANT CASE STUDIES

Based on the forecasted Year 2035 volumes on the two key regional arterials that will provide access to the sector, Paseo del Norte and Unser Boulevard, this section describes the general design and operational characteristics of several arterial streets in other cities for comparative purposes. In particular, the “case studies” cited below are of arterial streets that operate with acceptable levels of service, carrying similar volumes of motor vehicle traffic as forecasted on Paseo del Norte and Unser Boulevard, and include desired characteristics identified in the Sector Plan related to:

- Intersection spacing
- Narrower right-of-way configurations
- Multi-modal circulation elements

Paseo Del Norte Comparison: Lawrence Expressway

The Lawrence Expressway is a regional route through a portion of “Silicon Valley” in the San Francisco Bay Area, running approximately 8 miles from Saratoga Avenue (Saratoga) to US 237 (Sunnyvale) in Santa Clara County. The current and projected daily traffic volumes are similar to those projected for Paseo del Norte, as shown on Figure 3-1.

- Throughout its length the street has three mixed-flow traffic lanes in each direction, plus one high-occupancy vehicle (HOV) lane reserved for use by buses and carpools during peak periods.
- Most intersections are signalized at grade. Where it crosses regional freeways and some major regional streets, it has grade-separated intersections.
- The character of the surrounding area varies – in places sound walls separate the street from residential developments, while the northern half has office developments and large institutions such as hospitals fronting the street.

Figure 3-1 Current and Projected Average Daily Traffic Volumes on Lawrence Expressway

Roadway Segment	Existing (2008)		Future (2035)	
	ADT	LOS	ADT	LOS
Lawrence Expressway between US -101 Central Expressway	79,010	D	93,030	D
Lawrence Expressway between Central Expressway- Kifer Road	63,970	D	80,790	D
Lawrence Expressway between Kifer Road-Monroe Street	67,960	D	83,090	D
Lawrence Expressway between Monroe Street-Cabrillo Avenue	52,890	C	64,760	D
Lawrence Expressway between Cabrillo Avenue-El Camino Real	63,490	D	78,680	D
Lawrence Expressway between El Camino Real-Benton Street	58,230	D	70,840	D
Lawrence Expressway between Benton Street-Homestead Road	65,410	D	66,990	D
Lawrence Expressway between Homestead Road-Pruneridge Avenue	66,600	D	73,220	D
Lawrence Expressway between Pruneridge Avenue-Stevens Creek	62,890	D	68,990	D
Lawrence Expressway between El Camino Real and Reed	71,000	2008-2010 values from City of Sunnyvale 2010 LUTE Update existing conditions analysis		
Lawrence Expressway between Arques Ave and US 101	67,000			

Source: Santa Clara Public Hearing Draft General Plan, Appendix 8.7 Transportation and Mobility Assumptions, except where noted.

Level of Service

Traffic operations on the Lawrence Expressway are projected to remain at level of service D through the horizon year of 2035. While AASHTO defines LOS D as “approaching unstable flow,” in practice this is a fairly reasonable condition that many cities aspire to at peak times, with only slight reductions in vehicle speed and driver comfort. This LOS corresponds with the likely operation of Paseo del Norte at peak capacity.

Intersection Spacing

The distance between signalized intersections along the Lawrence Expressway varies. The table in Figure 3-2 summarizes the distance between the intersections in the segment shown in

Figure 3-3. For this particular segment the distances are very short, between 0.1 and 0.4 miles. While some sections of Lawrence do have greater distances between signalized intersections, the short distances in this segment are fairly typical.

Figure 3-2 Distance Between Signalized Intersections (Example Segment)

Pruneridge Ave and Lehigh Dr	1,455 feet (0.27 mile)
Lehigh Dr and Homestead Rd	905 feet (0.17 mile)
Homestead Rd and Lochinvar Ave	672 feet (0.13 mile)
Lochinvar Ave and Benton St	2,098 feet (0.39 mile)

Lawrence Expressway carries a similar volume of traffic as forecasted for Paseo del Norte and with less than one-fourth mile between signalized intersections on some segments.

Figure 3-3 Aerial View of Lawrence Expressway

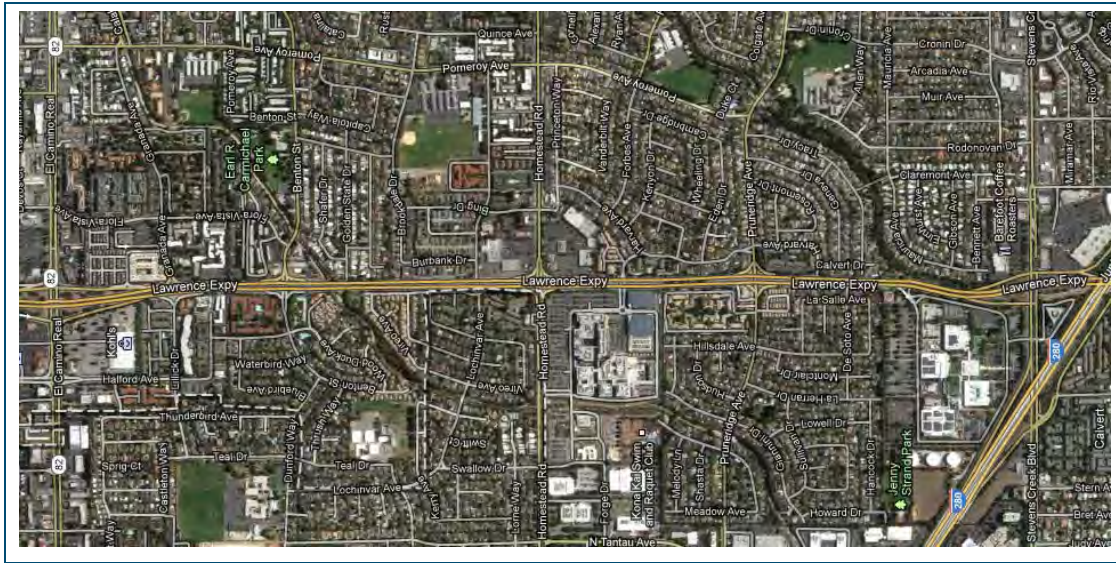

Lawrence Expressway between Junipero Serra (Interstate 280) and El Camino Real (State Route 82)

Source: Google Maps, © Google 2012

General Characteristics

The following images captured from Google Streetview provide an indication of the general nature of the Lawrence Expressway. It is clearly very much an auto-dominated streetscape, with narrow bike lanes and relatively narrow sidewalks with no planted strip separation from the street. In its favor, signalized intersections with crosswalks are closely spaced, which makes for an easier walking experience than if the street had ½ mile spacing between intersections. Newer developments have improved the street by adding planted berms and trees facing the street, as can be seen outside the Kaiser Hospital (below).

Figure 3-4 General Characteristics of Lawrence Expressway (Photo Examples)



Lawrence Expressway at Bollinger Road
Source: Google Maps Streetview, © Google 2012

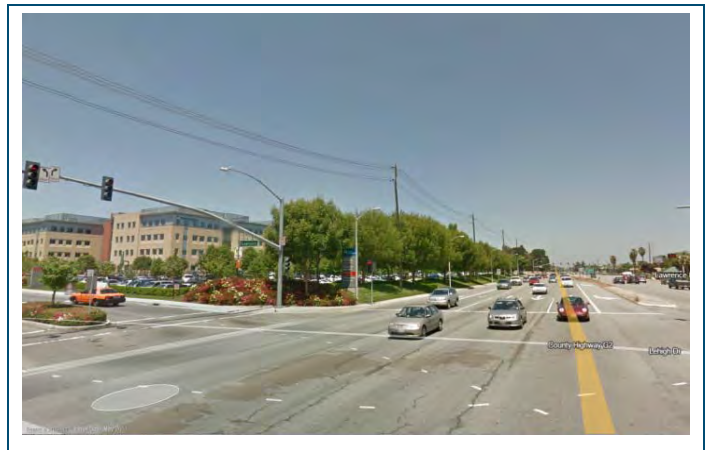

Lawrence Expressway at Lehigh Drive (Kaiser Permanente)
Source: Google Maps Streetview, © Google 2012

Volcano Heights Multi-modal Transportation Assessment
City of Albuquerque Planning Department – August 7, 2012



Lawrence Expressway at Miraloma Way
Source: Google Maps Streetview, © Google 2012



Lawrence Expressway at Prospect Road
Source: Google Maps Streetview, © Google 2012

Unser Boulevard, Comparison 1: Valencia Street

As noted earlier in this report, the forecasted Year 2035 traffic volume on Unser Boulevard is less than 15,000 daily vehicles. The planned roadway configuration includes four travel lanes and a generous median within a 156-foot right-of-way.

In comparison: Valencia Street in San Francisco carries 20,000 daily vehicles and 5,000 daily bicyclists, as well as a very high volumes of pedestrians, with just 2 motor vehicle lanes within a 62.5 foot right-of-way.

- A key advantage of the narrower right-of-way is that relatively short 60-second signal cycles can efficiently accommodate vehicle and pedestrian movements.
- Wider streets, by contrast, require lengthier 90 to 120 second cycles, resulting in lengthier vehicle queues and extended delays, including longer waits for pedestrians between “WALK” intervals.

Figure 3-5 Valencia Street (Photo)



Source: Google Maps Streetview, © Google 2012

Unser Boulevard Comparison 2: Octavia Boulevard

As noted earlier, the forecasted Year 2035 traffic volume on Unser Boulevard is less than 15,000 daily vehicles. The planned roadway configuration includes four travel lanes and a generous median within a 156-foot right-of-way.

In comparison: Octavia Boulevard in San Francisco carries 45,000 daily vehicles with the same number of travel lanes as planned for Unser Boulevard, within a 133-foot wide right-of-way that also accommodates on-street parking within a “boulevard configuration.” The cross-section for Octavia Boulevard, shown in Figure 3-6, has the same components as the cross section proposed for Unser Boulevard within Volcano Heights.

Figure 3-6 Octavia Boulevard Cross Section

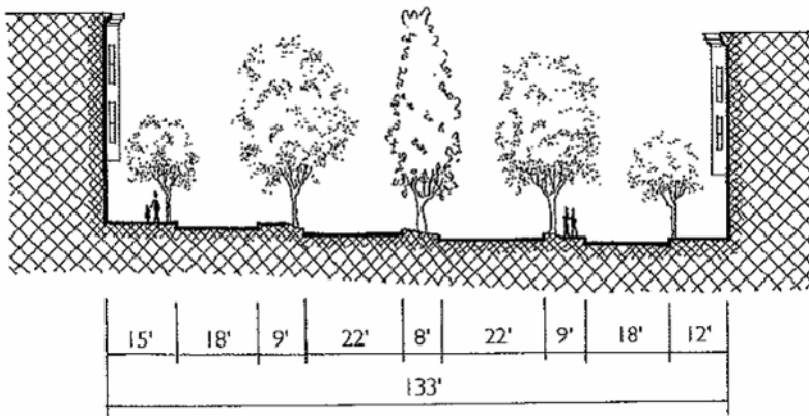

Figure 3-7 Octavia Boulevard Characteristics (Photo Examples)



Appendix A **Signal Timing & Level of Service
Reports**

Note: see Pages 22-24 for overview of turning movement and signal phasing assumptions.

Timings

1: Unser Blvd & Paseo del Norte

7/13/2012



Lane Group	SEL	SET	SER	NWL	NWT	NWR	NEL	NET	NER	SWL	SWT	SWR
Lane Configurations	↑↑	↑↑↑	↑	↑↑	↑↑↑	↑	↑↑	↑↑	↑	↑↑	↑↑	↑
Volume (vph)	200	2032	200	200	2498	200	100	916	100	100	822	100
Turn Type	Prot	NA	pm+ov	Prot	NA	pm+ov	Prot	NA	pm+ov	Prot	NA	pm+ov
Protected Phases	1	6	7	5	2	3	7	4	5	3	8	1
Permitted Phases			6			2			4			8
Detector Phase	1	6	7	5	2	3	7	4	5	3	8	1
Switch Phase												
Minimum Initial (s)	4.0	4.0	4.0	4.0	4.0	4.0	4.0	4.0	4.0	4.0	4.0	4.0
Minimum Split (s)	8.0	40.0	8.0	8.0	40.0	8.0	8.0	40.0	8.0	8.0	40.0	8.0
Total Split (s)	12.0	59.0	8.0	13.0	60.0	8.0	8.0	40.0	13.0	8.0	40.0	12.0
Total Split (%)	10.0%	49.2%	6.7%	10.8%	50.0%	6.7%	6.7%	33.3%	10.8%	6.7%	33.3%	10.0%
Yellow Time (s)	3.5	3.5	3.5	3.5	3.5	3.5	3.5	3.5	3.5	3.5	3.5	3.5
All-Red Time (s)	0.5	0.5	0.5	0.5	0.5	0.5	0.5	0.5	0.5	0.5	0.5	0.5
Lost Time Adjust (s)	0.0	0.0	0.0	0.0	0.0	0.0	0.0	0.0	0.0	0.0	0.0	0.0
Total Lost Time (s)	4.0	4.0	4.0	4.0	4.0	4.0	4.0	4.0	4.0	4.0	4.0	4.0
Lead/Lag	Lead	Lead	Lead	Lag	Lag	Lead	Lead	Lag	Lag	Lead	Lag	Lead
Lead-Lag Optimize?	Yes	Yes	Yes	Yes	Yes	Yes	Yes	Yes	Yes	Yes	Yes	Yes
Recall Mode	None	C-Max	None	None	C-Max	None	None	None	None	None	None	None
Act Effct Green (s)	8.5	55.9	59.9	9.0	56.4	64.4	4.0	35.1	44.1	4.0	35.1	47.6
Actuated g/C Ratio	0.07	0.47	0.50	0.08	0.47	0.54	0.03	0.29	0.37	0.03	0.29	0.40
v/c Ratio	0.85	0.89	0.26	0.80	1.08	0.24	0.90	0.92	0.18	0.90	0.82	0.16
Control Delay	78.8	24.0	4.5	76.3	79.8	21.3	116.4	41.4	21.0	99.9	33.0	15.5
Queue Delay	0.0	0.0	0.0	0.0	0.0	0.0	0.0	0.0	0.0	0.0	0.0	0.0
Total Delay	78.8	24.0	4.5	76.3	79.8	21.3	116.4	41.4	21.0	99.9	33.0	15.5
LOS	E	C	A	E	E	C	F	D	C	F	C	B
Approach Delay		26.9			75.5			46.3			37.9	
Approach LOS		C			E			D			D	

Intersection Summary

Cycle Length: 120
 Actuated Cycle Length: 120
 Offset: 52 (43%), Referenced to phase 2:NWT and 6:SET, Start of Green
 Natural Cycle: 120
 Control Type: Actuated-Coordinated
 Maximum v/c Ratio: 1.08
 Intersection Signal Delay: 50.2
 Intersection LOS: D
 Intersection Capacity Utilization 96.0%
 ICU Level of Service F
 Analysis Period (min) 15

Splits and Phases: 1: Unser Blvd & Paseo del Norte

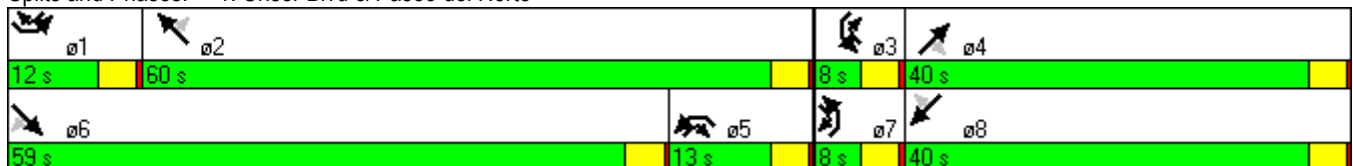

Timings

3: Transit Blvd & Unser Blvd

7/13/2012



Lane Group	EBT	WBL	WBT	NBL	NBR
Lane Configurations	↑↑	↑	↑↑	↑	↑
Volume (vph)	992	300	1458	200	300
Turn Type	NA	Prot	NA	NA	Perm
Protected Phases	4	3	8	2	
Permitted Phases					2
Detector Phase	4	3	8	2	2
Switch Phase					
Minimum Initial (s)	4.0	4.0	4.0	4.0	4.0
Minimum Split (s)	20.0	8.0	20.0	40.0	40.0
Total Split (s)	30.0	20.0	50.0	40.0	40.0
Total Split (%)	33.3%	22.2%	55.6%	44.4%	44.4%
Yellow Time (s)	3.5	3.5	3.5	3.5	3.5
All-Red Time (s)	0.5	0.5	0.5	0.5	0.5
Lost Time Adjust (s)	0.0	0.0	0.0	0.0	0.0
Total Lost Time (s)	4.0	4.0	4.0	4.0	4.0
Lead/Lag	Lag	Lead			
Lead-Lag Optimize?	Yes	Yes			
Recall Mode	None	None	None	C-Max	C-Max
Act Effct Green (s)	26.0	16.0	46.0	36.0	36.0
Actuated g/C Ratio	0.29	0.18	0.51	0.40	0.40
v/c Ratio	0.97	0.95	0.81	0.28	0.37
Control Delay	54.7	78.8	22.7	19.6	3.6
Queue Delay	0.0	0.0	0.0	0.0	0.0
Total Delay	54.7	78.8	22.7	19.6	3.6
LOS	D	E	C	B	A
Approach Delay	54.7		32.3	10.0	
Approach LOS	D		C	B	

Intersection Summary

Cycle Length: 90

Actuated Cycle Length: 90

Offset: 0 (0%), Referenced to phase 2:NBL and 6:, Start of Green

Natural Cycle: 90

Control Type: Actuated-Coordinated

Maximum v/c Ratio: 0.97

Intersection Signal Delay: 35.7

Intersection LOS: D

Intersection Capacity Utilization 65.1%

ICU Level of Service C

Analysis Period (min) 15

Splits and Phases: 3: Transit Blvd & Unser Blvd

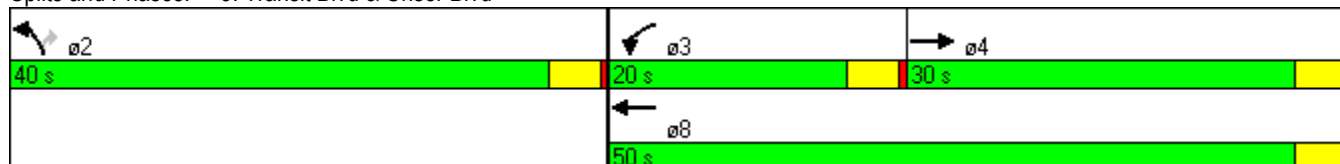

Timings

6: Unser Blvd & SW Connector/SE Connector

7/13/2012



Lane Group	EBL	EBT	EBR	WBL	WBT	WBR	NBL	NBT	SBL	SBT	SBR
Lane Configurations	↖	↑	↗	↖	↑	↗	↖	↑↑	↖	↑↑	↗
Volume (vph)	100	300	100	100	300	100	100	1325	100	993	100
Turn Type	Prot	NA	Perm	Prot	NA	Perm	Prot	NA	Prot	NA	Perm
Protected Phases	7	4		3	8		5	2	1	6	
Permitted Phases			4			8					6
Detector Phase	7	4	4	3	8	8	5	2	1	6	6
Switch Phase											
Minimum Initial (s)	4.0	4.0	4.0	4.0	4.0	4.0	4.0	4.0	4.0	4.0	4.0
Minimum Split (s)	8.0	40.0	40.0	8.0	40.0	40.0	8.0	20.0	8.0	20.0	20.0
Total Split (s)	20.0	40.0	40.0	20.0	40.0	40.0	20.0	40.0	20.0	40.0	40.0
Total Split (%)	16.7%	33.3%	33.3%	16.7%	33.3%	33.3%	16.7%	33.3%	16.7%	33.3%	33.3%
Yellow Time (s)	3.5	3.5	3.5	3.5	3.5	3.5	3.5	3.5	3.5	3.5	3.5
All-Red Time (s)	0.5	0.5	0.5	0.5	0.5	0.5	0.5	0.5	0.5	0.5	0.5
Lost Time Adjust (s)	0.0	0.0	0.0	0.0	0.0	0.0	0.0	0.0	0.0	0.0	0.0
Total Lost Time (s)	4.0	4.0	4.0	4.0	4.0	4.0	4.0	4.0	4.0	4.0	4.0
Lead/Lag	Lead	Lag	Lag	Lead	Lag	Lag	Lead	Lag	Lead	Lag	Lag
Lead-Lag Optimize?	Yes	Yes	Yes	Yes	Yes	Yes	Yes	Yes	Yes	Yes	Yes
Recall Mode	None	None	None	None	None	None	None	C-Max	None	C-Max	C-Max
Act Effct Green (s)	11.9	24.9	24.9	11.9	24.9	24.9	12.3	55.0	12.1	54.8	54.8
Actuated g/C Ratio	0.10	0.21	0.21	0.10	0.21	0.21	0.10	0.46	0.10	0.46	0.46
v/c Ratio	0.57	0.78	0.26	0.57	0.78	0.25	0.57	0.92	0.56	0.64	0.14
Control Delay	63.5	58.1	14.7	64.9	86.1	36.2	63.3	42.2	69.6	26.2	10.7
Queue Delay	0.0	0.0	0.0	0.0	0.0	0.0	0.0	0.0	0.0	0.0	0.0
Total Delay	63.5	58.1	14.7	64.9	86.1	36.2	63.3	42.2	69.6	26.2	10.7
LOS	E	E	B	E	F	D	E	D	E	C	B
Approach Delay		50.5			71.9			43.6		28.5	
Approach LOS		D			E			D		C	

Intersection Summary

Cycle Length: 120

Actuated Cycle Length: 120

Offset: 0 (0%), Referenced to phase 2:NBT and 6:SBT, Start of Green

Natural Cycle: 110

Control Type: Actuated-Coordinated

Maximum v/c Ratio: 0.92

Intersection Signal Delay: 43.5

Intersection LOS: D

Intersection Capacity Utilization 80.0%

ICU Level of Service D

Analysis Period (min) 15

Splits and Phases: 6: Unser Blvd & SW Connector/SE Connector

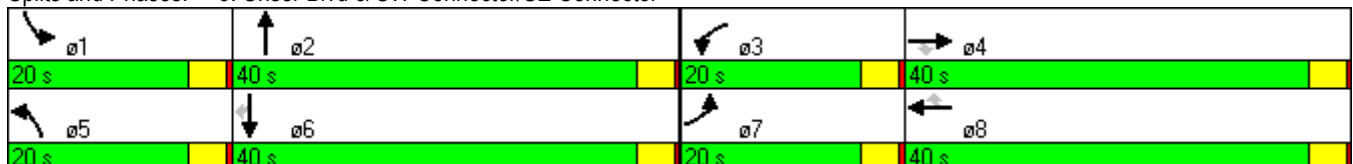

Timings

8: Paseo del Norte & East Connector

7/13/2012



Lane Group	EBL	EBT	EBR	WBL	WBT	WBR	NBL	NBT	NBR	SBL	SBT	SBR
Lane Configurations	↖↗	↑↑↑	↖	↖	↑↑↑	↖	↖	↑	↖	↖	↑	↖
Volume (vph)	200	2409	200	100	2038	200	200	200	200	200	200	200
Turn Type	Prot	NA	Perm	Prot	NA	Perm	Perm	NA	Perm	Perm	NA	Perm
Protected Phases	7	4		3	8			2			6	
Permitted Phases			4			8	2		2	6		6
Detector Phase	7	4	4	3	8	8	2	2	2	6	6	6
Switch Phase												
Minimum Initial (s)	4.0	4.0	4.0	4.0	4.0	4.0	4.0	4.0	4.0	4.0	4.0	4.0
Minimum Split (s)	8.0	20.0	20.0	8.0	20.0	20.0	40.0	40.0	40.0	20.0	20.0	20.0
Total Split (s)	21.0	60.0	60.0	20.0	59.0	59.0	40.0	40.0	40.0	40.0	40.0	40.0
Total Split (%)	17.5%	50.0%	50.0%	16.7%	49.2%	49.2%	33.3%	33.3%	33.3%	33.3%	33.3%	33.3%
Yellow Time (s)	3.5	3.5	3.5	3.5	3.5	3.5	3.5	3.5	3.5	3.5	3.5	3.5
All-Red Time (s)	0.5	0.5	0.5	0.5	0.5	0.5	0.5	0.5	0.5	0.5	0.5	0.5
Lost Time Adjust (s)	0.0	0.0	0.0	0.0	0.0	0.0	0.0	0.0	0.0	0.0	0.0	0.0
Total Lost Time (s)	4.0	4.0	4.0	4.0	4.0	4.0	4.0	4.0	4.0	4.0	4.0	4.0
Lead/Lag	Lead	Lag	Lag	Lead	Lag	Lag						
Lead-Lag Optimize?	Yes											
Recall Mode	None	Max	Max	None	Max	Max	C-Min	C-Min	C-Min	C-Max	C-Max	C-Max
Act Effct Green (s)	12.3	59.9	59.9	12.1	59.7	59.7	36.0	36.0	36.0	36.0	36.0	36.0
Actuated g/C Ratio	0.10	0.50	0.50	0.10	0.50	0.50	0.30	0.30	0.30	0.30	0.30	0.30
v/c Ratio	0.57	0.98	0.23	0.58	0.83	0.23	0.69	0.36	0.33	0.69	0.36	0.33
Control Delay	57.7	46.8	3.4	64.4	30.1	3.1	51.1	35.2	5.8	51.1	35.2	5.8
Queue Delay	0.0	0.0	0.0	0.0	0.0	0.0	0.0	0.0	0.0	0.0	0.0	0.0
Total Delay	57.7	46.8	3.4	64.4	30.1	3.1	51.1	35.2	5.8	51.1	35.2	5.8
LOS	E	D	A	E	C	A	D	D	A	D	D	A
Approach Delay		44.5			29.3			30.7			30.7	
Approach LOS		D			C			C			C	

Intersection Summary

Cycle Length: 120
 Actuated Cycle Length: 120
 Offset: 118 (98%), Referenced to phase 2:NBTL and 6:SBTL, Start of Green
 Natural Cycle: 100
 Control Type: Actuated-Coordinated
 Maximum v/c Ratio: 0.98
 Intersection Signal Delay: 36.3
 Intersection LOS: D
 Intersection Capacity Utilization 87.0%
 ICU Level of Service E
 Analysis Period (min) 15

Splits and Phases: 8: Paseo del Norte & East Connector

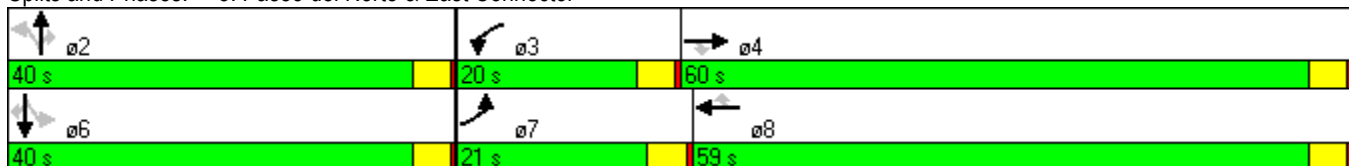

Timings

9: Paseo del Norte & Transit Blvd

7/13/2012



Lane Group	EBL	EBT	WBT	WBR	SBL	SBR
Lane Configurations	↖	↑↑↑	↑↑↑	↗	↖	↗
Volume (vph)	250	2000	2500	250	250	250
Turn Type	Prot	NA	NA	Perm	NA	Perm
Protected Phases	7	4	8		6	
Permitted Phases				8		6
Detector Phase	7	4	8	8	6	6
Switch Phase						
Minimum Initial (s)	4.0	4.0	4.0	4.0	4.0	4.0
Minimum Split (s)	8.0	20.0	20.0	20.0	20.0	20.0
Total Split (s)	30.0	100.0	70.0	70.0	20.0	20.0
Total Split (%)	25.0%	83.3%	58.3%	58.3%	16.7%	16.7%
Yellow Time (s)	3.5	3.5	3.5	3.5	3.5	3.5
All-Red Time (s)	0.5	0.5	0.5	0.5	0.5	0.5
Lost Time Adjust (s)	0.0	0.0	0.0	0.0	0.0	0.0
Total Lost Time (s)	4.0	4.0	4.0	4.0	4.0	4.0
Lead/Lag	Lag		Lead	Lead		
Lead-Lag Optimize?						
Recall Mode	None	C-Max	C-Max	C-Max	Max	Max
Act Effct Green (s)	26.0	96.0	66.0	66.0	16.0	16.0
Actuated g/C Ratio	0.22	0.80	0.55	0.55	0.13	0.13
v/c Ratio	0.65	0.49	0.89	0.26	1.06	0.58
Control Delay	35.2	1.7	27.5	3.6	124.9	11.8
Queue Delay	0.0	0.0	0.0	0.0	0.0	0.0
Total Delay	35.2	1.7	27.5	3.6	124.9	11.8
LOS	D	A	C	A	F	B
Approach Delay		5.4	25.3		68.3	
Approach LOS		A	C		E	

Intersection Summary

Cycle Length: 120

Actuated Cycle Length: 120

Offset: 96 (80%), Referenced to phase 4:EBT and 8:WBT, Start of Green

Natural Cycle: 80

Control Type: Actuated-Coordinated

Maximum v/c Ratio: 1.06

Intersection Signal Delay: 21.1

Intersection LOS: C

Intersection Capacity Utilization 86.0%

ICU Level of Service E

Analysis Period (min) 15

Splits and Phases: 9: Paseo del Norte & Transit Blvd

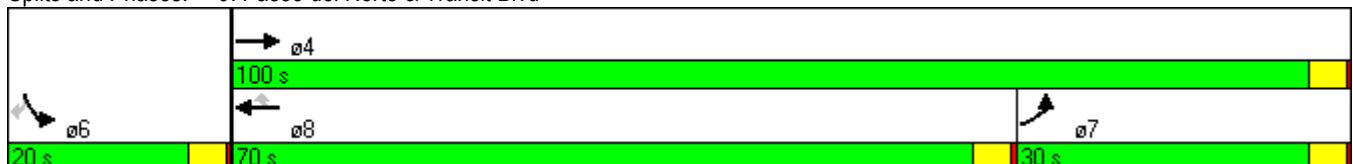

Timings

10: NE Connector & Paseo del Norte

7/13/2012



Lane Group	SEL	SET	SER	NWL	NWT	NWR	NET	NER	SWT	SWR
Lane Configurations										
Volume (vph)	200	2032	100	300	2498	100	250	500	250	200
Turn Type	Prot	NA	Perm	Prot	NA	Perm	NA	pm+ov	NA	pm+ov
Protected Phases	1	6		5	2		4	5	8	1
Permitted Phases			6			2		4	8	8
Detector Phase	1	6	6	5	2	2	4	5	8	1
Switch Phase										
Minimum Initial (s)	4.0	4.0	4.0	4.0	4.0	4.0	4.0	4.0	4.0	4.0
Minimum Split (s)	8.0	26.0	26.0	20.0	26.0	26.0	20.0	20.0	20.0	8.0
Total Split (s)	29.0	66.0	66.0	34.0	71.0	71.0	20.0	34.0	20.0	29.0
Total Split (%)	24.2%	55.0%	55.0%	28.3%	59.2%	59.2%	16.7%	28.3%	16.7%	24.2%
Yellow Time (s)	3.5	3.5	3.5	3.5	3.5	3.5	3.5	3.5	3.5	3.5
All-Red Time (s)	0.5	0.5	0.5	0.5	0.5	0.5	0.5	0.5	0.5	0.5
Lost Time Adjust (s)	0.0	0.0	0.0	0.0	0.0	0.0	0.0	0.0	0.0	0.0
Total Lost Time (s)	4.0	4.0	4.0	4.0	4.0	4.0	4.0	4.0	4.0	4.0
Lead/Lag	Lag	Lag	Lag	Lead	Lead	Lead		Lead		Lag
Lead-Lag Optimize?	Yes	Yes	Yes	Yes	Yes	Yes		Yes		Yes
Recall Mode	None	Max	Max	Max	C-Max	C-Max	None	Max	None	None
Act Effct Green (s)	25.0	62.0	62.0	32.0	69.0	69.0	14.0	50.0	14.0	43.0
Actuated g/C Ratio	0.21	0.52	0.52	0.27	0.58	0.58	0.12	0.42	0.12	0.36
v/c Ratio	0.62	0.89	0.13	0.38	0.98	0.12	0.67	0.84	0.67	0.39
Control Delay	70.6	51.4	16.6	53.4	39.3	8.4	66.6	45.2	60.8	32.6
Queue Delay	0.0	0.0	0.0	0.0	0.0	0.0	0.0	0.0	0.0	0.0
Total Delay	70.6	51.4	16.6	53.4	39.3	8.4	66.6	45.2	60.8	32.6
LOS	E	D	B	D	D	A	E	D	E	C
Approach Delay		51.5			39.7		52.3		48.3	
Approach LOS		D			D		D		D	

Intersection Summary

Cycle Length: 120
 Actuated Cycle Length: 120
 Offset: 75 (63%), Referenced to phase 2:NWT, Start of Green
 Natural Cycle: 90
 Control Type: Actuated-Coordinated
 Maximum v/c Ratio: 0.98
 Intersection Signal Delay: 46.1
 Intersection LOS: D
 Intersection Capacity Utilization 84.7%
 ICU Level of Service E
 Analysis Period (min) 15

Splits and Phases: 10: NE Connector & Paseo del Norte

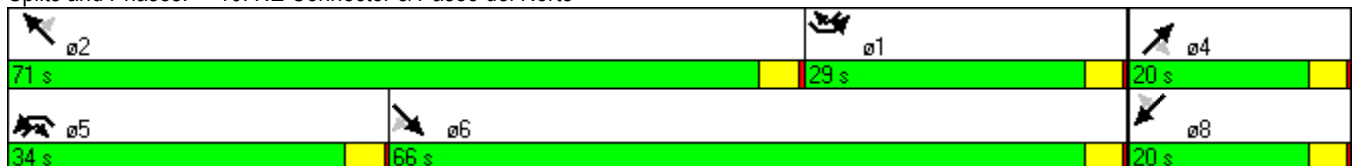

Timings

11: Universe & Paseo del Norte

7/13/2012

Lane Group	EBL	EBT	EBR	WBL	WBT	WBR	NBL	NBT	NBR	SBL	SBT	SBR
Lane Configurations												
Volume (vph)	200	1632	200	100	2051	300	200	600	100	500	600	200
Turn Type	Prot	NA	Perm	Prot	NA	Perm	Prot	NA	Perm	Prot	NA	Perm
Protected Phases	7	4		3	8		5	2		1	6	
Permitted Phases			4			8			2			6
Detector Phase	7	4	4	3	8	8	5	2	2	1	6	6
Switch Phase												
Minimum Initial (s)	4.0	4.0	4.0	4.0	4.0	4.0	4.0	4.0	4.0	4.0	4.0	4.0
Minimum Split (s)	8.0	20.0	20.0	8.0	20.0	20.0	8.0	20.0	20.0	8.0	20.0	20.0
Total Split (s)	12.0	57.0	57.0	11.0	56.0	56.0	16.0	29.0	29.0	23.0	36.0	36.0
Total Split (%)	10.0%	47.5%	47.5%	9.2%	46.7%	46.7%	13.3%	24.2%	24.2%	19.2%	30.0%	30.0%
Yellow Time (s)	3.5	3.5	3.5	3.5	3.5	3.5	3.5	3.5	3.5	3.5	3.5	3.5
All-Red Time (s)	0.5	0.5	0.5	0.5	0.5	0.5	0.5	0.5	0.5	0.5	0.5	0.5
Lost Time Adjust (s)	0.0	0.0	0.0	0.0	0.0	0.0	0.0	0.0	0.0	0.0	0.0	0.0
Total Lost Time (s)	4.0	4.0	4.0	4.0	4.0	4.0	4.0	4.0	4.0	4.0	4.0	4.0
Lead/Lag	Lead	Lag	Lag	Lead	Lag	Lag	Lead	Lag	Lag	Lead	Lag	Lag
Lead-Lag Optimize?	Yes	Yes	Yes	Yes	Yes	Yes	Yes	Yes	Yes	Yes	Yes	Yes
Recall Mode	None	None	None	None	None	None	None	C-Max	C-Max	None	C-Max	C-Max
Act Effct Green (s)	8.0	53.1	53.1	6.9	52.0	52.0	11.2	25.0	25.0	19.0	32.8	32.8
Actuated g/C Ratio	0.07	0.44	0.44	0.06	0.43	0.43	0.09	0.21	0.21	0.16	0.27	0.27
v/c Ratio	0.90	0.75	0.26	0.52	0.96	0.39	0.65	0.84	0.25	0.95	0.64	0.40
Control Delay	96.0	30.6	6.0	57.6	47.6	10.1	62.4	57.6	9.3	79.1	42.4	17.0
Queue Delay	0.0	0.0	0.0	0.0	0.0	0.0	0.0	0.0	0.0	0.0	0.0	0.0
Total Delay	96.0	30.6	6.0	57.6	47.6	10.1	62.4	57.6	9.3	79.1	42.4	17.0
LOS	F	C	A	E	D	B	E	E	A	E	D	B
Approach Delay		34.6			43.4			53.3			52.6	
Approach LOS		C			D			D			D	

Intersection Summary

Cycle Length: 120

Actuated Cycle Length: 120

Offset: 0 (0%), Referenced to phase 2:NBT and 6:SBT, Start of Green, Master Intersection

Natural Cycle: 90

Control Type: Actuated-Coordinated

Maximum v/c Ratio: 0.96

Intersection Signal Delay: 43.9

Intersection LOS: D

Intersection Capacity Utilization 89.5%

ICU Level of Service E

Analysis Period (min) 15

Splits and Phases: 11: Universe & Paseo del Norte

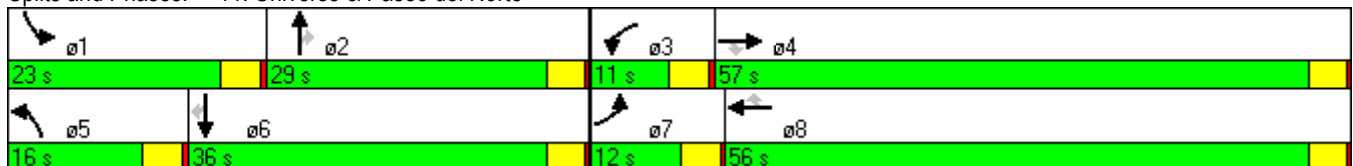

Timings

22: SW Connector/NW Connector & Paseo del Norte

7/13/2012



Lane Group	SEL	SET	SER	NWL	NWT	NWR	NET	NER	SWT	SWR
Lane Configurations	↖↖	↑↑↑	↗	↖↖	↑↑↑	↗	↑↑	↗	↑↑	↗
Volume (vph)	500	2451	250	200	2032	200	300	200	300	500
Turn Type	Prot	NA	Perm	Prot	NA	Perm	NA	pm+ov	NA	pm+ov
Protected Phases	1	6		5	2		4	5	8	1
Permitted Phases			6			2	4	4		8
Detector Phase	1	6	6	5	2	2	4	5	8	1
Switch Phase										
Minimum Initial (s)	4.0	4.0	4.0	4.0	4.0	4.0	4.0	4.0	4.0	4.0
Minimum Split (s)	8.0	40.0	40.0	8.0	22.0	22.0	40.0	8.0	22.0	8.0
Total Split (s)	20.0	60.0	60.0	20.0	60.0	60.0	40.0	20.0	40.0	20.0
Total Split (%)	16.7%	50.0%	50.0%	16.7%	50.0%	50.0%	33.3%	16.7%	33.3%	16.7%
Yellow Time (s)	3.5	3.5	3.5	3.5	3.5	3.5	3.5	3.5	3.5	3.5
All-Red Time (s)	0.5	0.5	0.5	0.5	0.5	0.5	0.5	0.5	0.5	0.5
Lost Time Adjust (s)	0.0	0.0	0.0	0.0	0.0	0.0	0.0	0.0	0.0	0.0
Total Lost Time (s)	4.0	4.0	4.0	4.0	4.0	4.0	4.0	4.0	4.0	4.0
Lead/Lag	Lag	Lag	Lag	Lead	Lead	Lead		Lead		Lag
Lead-Lag Optimize?	Yes	Yes	Yes	Yes	Yes	Yes		Yes		Yes
Recall Mode	None	C-Max	C-Max	None	C-Max	C-Max	None	None	None	None
Act Effct Green (s)	16.0	76.7	76.7	12.5	73.2	73.2	18.8	35.3	18.8	38.8
Actuated g/C Ratio	0.13	0.64	0.64	0.10	0.61	0.61	0.16	0.29	0.16	0.32
v/c Ratio	1.13	0.78	0.24	0.58	0.68	0.20	0.54	0.43	0.54	0.97
Control Delay	129.4	25.0	10.6	37.1	26.8	9.8	49.0	35.0	51.5	73.8
Queue Delay	0.0	0.0	0.0	0.0	0.0	0.0	0.0	0.0	0.0	0.0
Total Delay	129.4	25.0	10.6	37.1	26.8	9.8	49.0	35.0	51.5	73.8
LOS	F	C	B	D	C	A	D	D	D	E
Approach Delay		40.2			26.2		43.4		65.4	
Approach LOS		D			C		D		E	

Intersection Summary

Cycle Length: 120
 Actuated Cycle Length: 120
 Offset: 22 (18%), Referenced to phase 2:NWT and 6:SET, Start of Green
 Natural Cycle: 100
 Control Type: Actuated-Coordinated
 Maximum v/c Ratio: 1.13
 Intersection Signal Delay: 38.4
 Intersection LOS: D
 Intersection Capacity Utilization 76.9%
 ICU Level of Service D
 Analysis Period (min) 15

Splits and Phases: 22: SW Connector/NW Connector & Paseo del Norte

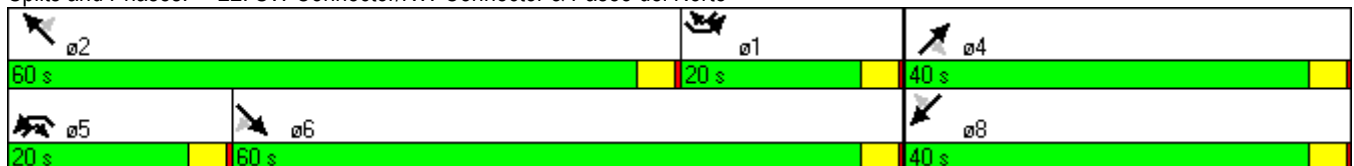

Timings

53: Unser Blvd & NE Connector/NW Connector

7/13/2012



Lane Group	SEL	SET	NWL	NWT	NEL	NET	NER	SWL	SWT	SWR
Lane Configurations	↖↖	↗	↖	↕	↖	↕↕	↗	↖	↕↕	↗
Volume (vph)	400	300	200	300	200	800	200	200	900	200
Turn Type	Prot	NA	Prot	NA	Prot	NA	Perm	Prot	NA	Perm
Protected Phases	1	6	5	2	7	4		3	8	
Permitted Phases							4			8
Detector Phase	1	6	5	2	7	4	4	3	8	8
Switch Phase										
Minimum Initial (s)	4.0	4.0	4.0	4.0	4.0	4.0	4.0	4.0	4.0	4.0
Minimum Split (s)	20.0	20.0	8.0	20.0	8.0	20.0	20.0	8.0	20.0	20.0
Total Split (s)	20.0	40.0	20.0	40.0	20.0	40.0	40.0	20.0	40.0	40.0
Total Split (%)	16.7%	33.3%	16.7%	33.3%	16.7%	33.3%	33.3%	16.7%	33.3%	33.3%
Yellow Time (s)	3.5	3.5	3.5	3.5	3.5	3.5	3.5	3.5	3.5	3.5
All-Red Time (s)	0.5	0.5	0.5	0.5	0.5	0.5	0.5	0.5	0.5	0.5
Lost Time Adjust (s)	0.0	0.0	0.0	0.0	0.0	0.0	0.0	0.0	0.0	0.0
Total Lost Time (s)	4.0	4.0	4.0	4.0	4.0	4.0	4.0	4.0	4.0	4.0
Lead/Lag	Lead	Lead	Lag	Lag	Lead	Lag	Lag	Lead	Lag	Lag
Lead-Lag Optimize?	Yes	Yes	Yes	Yes	Yes	Yes	Yes	Yes	Yes	Yes
Recall Mode	Max	C-Max	None	None	None	None	None	None	None	None
Act Effct Green (s)	17.9	37.9	15.5	35.5	15.5	35.1	35.1	15.5	35.1	35.1
Actuated g/C Ratio	0.15	0.32	0.13	0.30	0.13	0.29	0.29	0.13	0.29	0.29
v/c Ratio	0.78	0.87	0.87	0.46	0.87	0.77	0.37	0.87	0.87	0.38
Control Delay	55.8	29.9	85.5	26.0	56.0	51.4	29.4	85.5	50.5	20.1
Queue Delay	0.0	0.0	0.0	0.0	0.0	0.0	0.0	0.0	0.0	0.0
Total Delay	55.8	29.9	85.5	26.0	56.0	51.4	29.4	85.5	50.5	20.1
LOS	E	C	F	C	E	D	C	F	D	C
Approach Delay		41.4		43.0		48.5			51.2	
Approach LOS		D		D		D			D	

Intersection Summary

Cycle Length: 120
 Actuated Cycle Length: 120
 Offset: 0 (0%), Referenced to phase 6:SET, Start of Green
 Natural Cycle: 80
 Control Type: Actuated-Coordinated
 Maximum v/c Ratio: 0.87
 Intersection Signal Delay: 46.9
 Intersection LOS: D
 Intersection Capacity Utilization 88.4%
 ICU Level of Service E
 Analysis Period (min) 15

Splits and Phases: 53: Unser Blvd & NE Connector/NW Connector

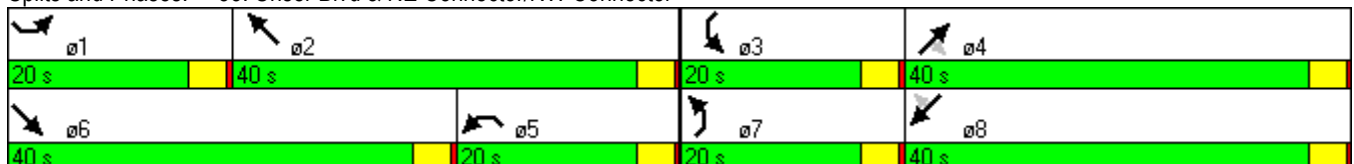



MEMORANDUM

To: Mikaela Renz-Whitmore, City of Albuquerque Planning Department
From: Colin Burgett
Date: UPDATE June 6, 2013
Subject: Volcano Heights Sector Development Plan: Proposed Intersection Spacing

INTRODUCTION & PURPOSE

The purpose of this memorandum is to summarize the assessment of proposed intersection spacing options currently being considered to provide future access from Paseo del Norte and Under Boulevard to future mixed-use development envisioned under the *Volcano Heights Sector Development Plan*.

PROPOSED INTERSECTION SPACING

Four options were identified by City staff for analysis, as shown on Pages 3 through 6:

- **Scheme A:** Spacing as recommended by the Volcano Heights Sector Development Plan (VHSDP)
- **Scheme B:** Spacing based on existing ½ mile full access intersections with right-in/right-out intersections assumed at least every ¼ mile
- **Scheme C:** Compromise spacing based on negotiations with NMDOT, TCC ad hoc committee, and RAC members
- **Scheme D:** Final City Request based on the results of this requested additional analysis

STREET CLASSIFICATIONS

Paseo del Norte and Unser Boulevard are both identified as high-capacity **Principal Arterial** streets. As stated in the New Mexico Department of Transportation Access Management Manual.

The State Access Management Manual provides the following functional definition of Principal Arterials located within urban areas:

State Access Management Manual Chapter 4

E. ACCESS CATEGORY: Urban Principal Arterial (UPA)

(1) Functional Description: The urban principal arterial system serves the major centers of activity of urbanized areas, the highest traffic volume corridors, the longest trip desires, and carries a high proportion of the total urban area travel on a minimum of mileage. The system is integrated both internally and between major rural connections. The principal arterial system carries most of the trips entering and leaving an urban area, as well as most of the through movements bypassing central city areas. In addition, significant intra-area travel, such as between central business districts and outlying residential areas, between major inner city communities, and between major suburban centers, is served by this class of highway. In urbanized areas, this system provides continuity for all rural arterials that intercept the urban boundary.

Scheme A: Volcano Heights Sector Development Plan

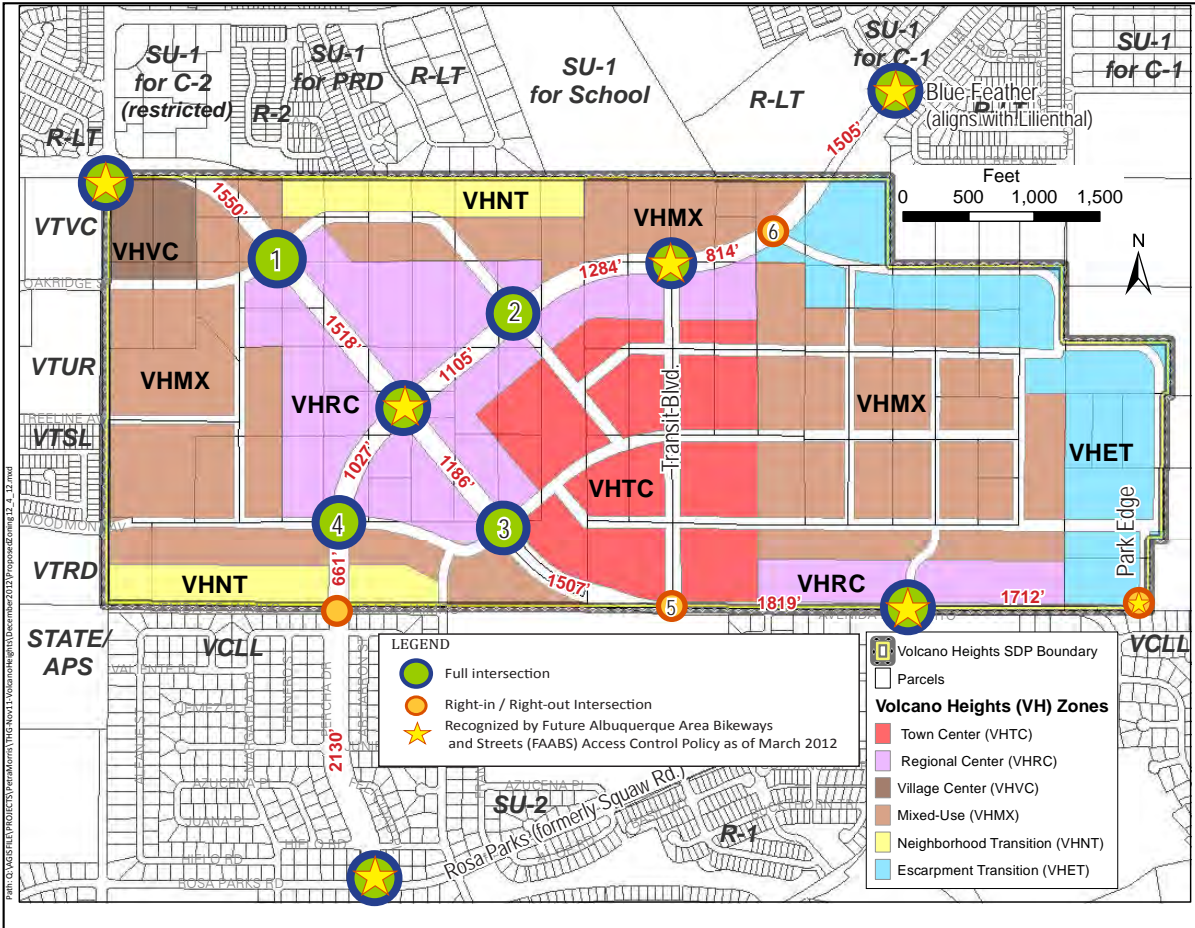

* 1/4 mile = 1320 feet
 1/3 mile = 1760 feet
 1/2 mile = 2640 feet

Scheme C: Compromise Spacing

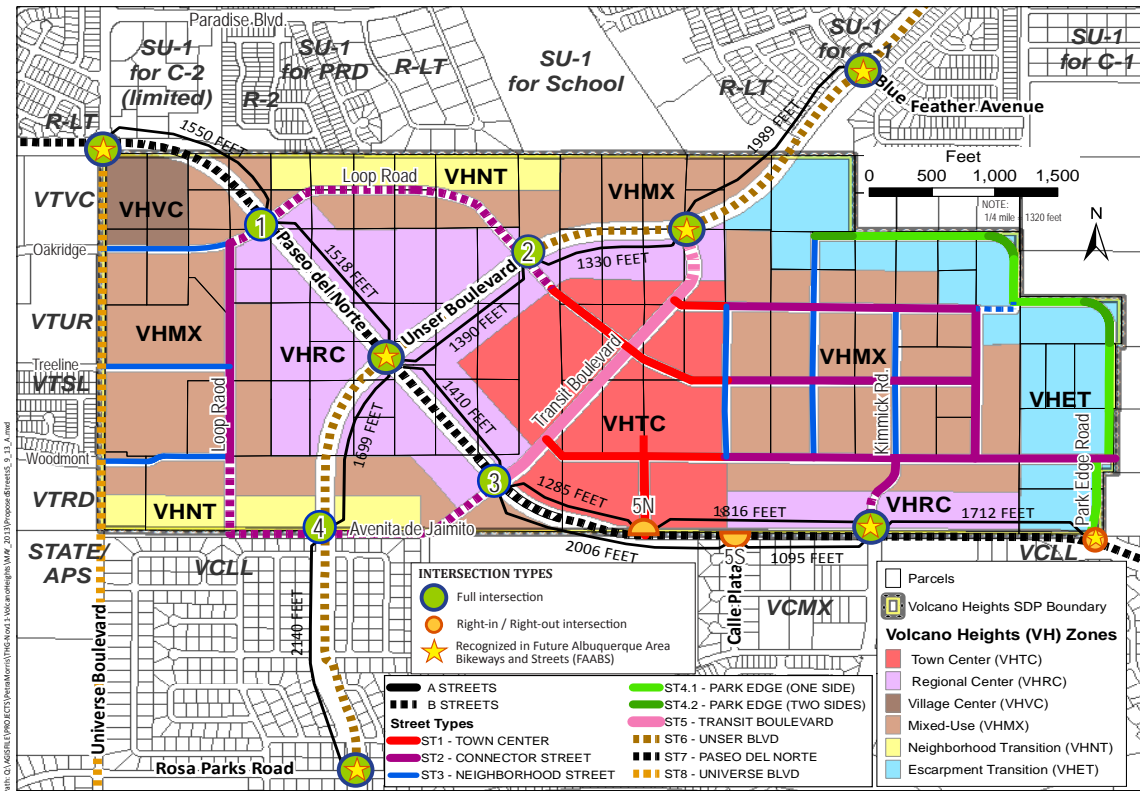

Note: 1/2 mile = 2640 feet
 1/3 mile = 1760 feet
 1/4 mile = 1720 feet

DRAFT

Scheme D: Final City Request

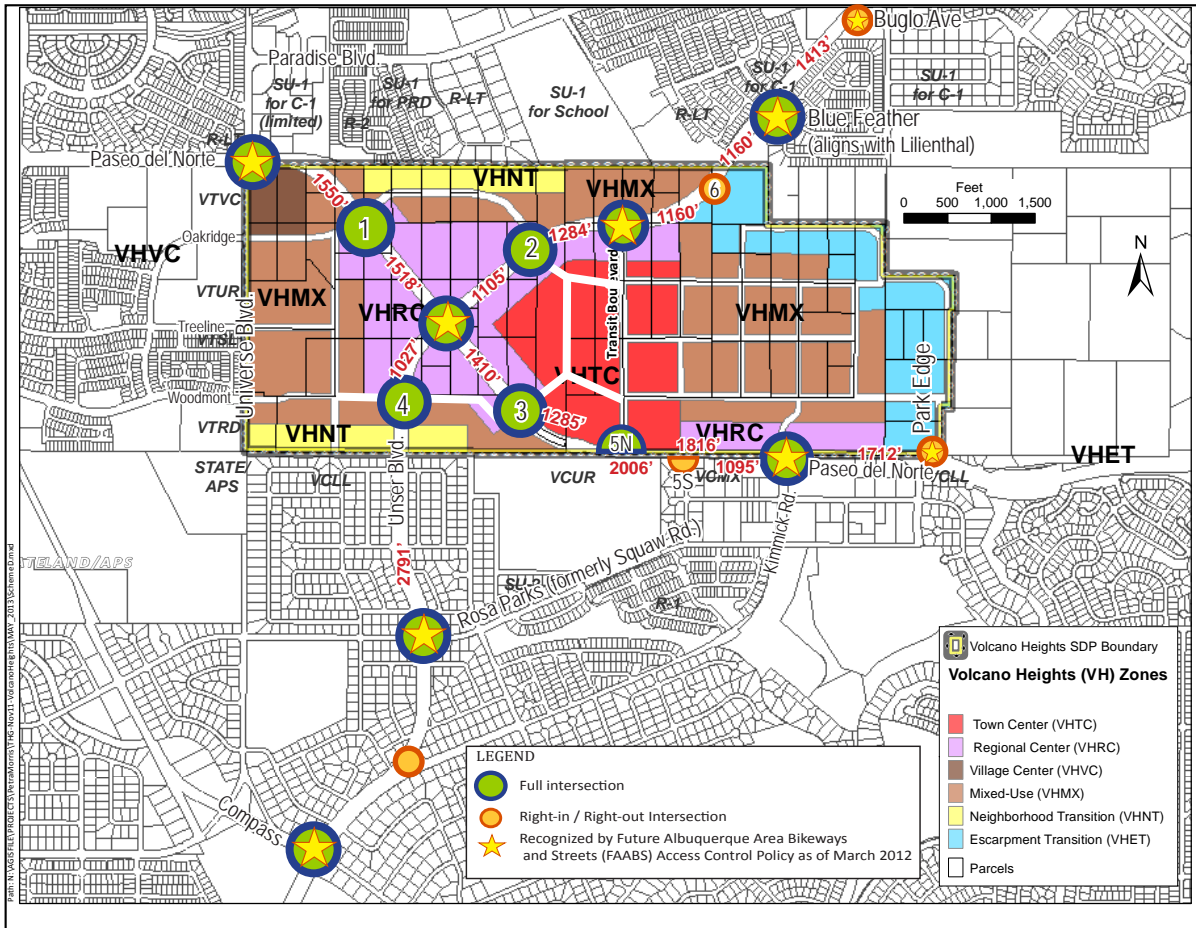

* 1/4 mile = 1320 feet
 1/3 mile = 1760 feet
 1/2 mile = 2640 feet

EVALUATION CRITERIA

This assessment will compare the four schemes based on the following criteria:

- **Intersection Level of Service (LOS):** the State Access Manual identified level of service D or better as acceptable.
- **Average Travel Speed:** Using Synchro analysis software, average travel speed was estimated under each of the four schemes, with a comparison provided.

TRAFFIC VOLUMES

Existing Volumes

Based on May 2013 traffic count data:

- Paseo del Norte currently carries approximately 16,000 daily vehicles (west of Kimmick).
- Unser Boulevard currently carries approximately 11,000 daily vehicles (south of Paradise Drive and north of Paseo del Norte).

Regional Growth

MRCOG Year 2035 model predicts the following future growth:

- Paseo del Norte will carry 53,000 to 63,000 daily vehicles (approximately 5,000 during the PM Peak Hour)
- Unser Boulevard will carry 14,000 to 25,000 daily vehicles (approximately 2,500 during the PM Peak Hour) in the Plan area. MRCOG's model assumes that Unser through the Plan area only carries the traffic market between Universe on the West and Golf Course on the East. Beyond those streets, traffic follows the shortest direction route – largely Rainbow Boulevard to Unser south of the Plan area or Paradise Boulevard to Paseo east of the Plan area.
- The variance in volumes between different segments partially reflects turning movements on/off intersecting arterials, as well as local trip patterns.
- Volcano Heights will attract a large portion of trips:
 - **Approximately 5,000 in & out to trips to/from Volcano Heights during the PM Peak Hour**
 - Based on this forecast: **Approximately 40 percent of vehicles approaching on Paseo del Norte and Unser will be trips beginning or ending at Volcano Heights.**
 - **Therefore: Travel-time goals may need to be balanced with site-access goals, in that Volcano Heights will serve as a key destination, or “regional center.” Inherent in the State Access Manual standards is the function of Principal Arterials: to provide access to and between major centers.**

Volcano Heights SDP: Proposed Intersection Spacing
 City of Albuquerque Planning Department – June 6, 2013

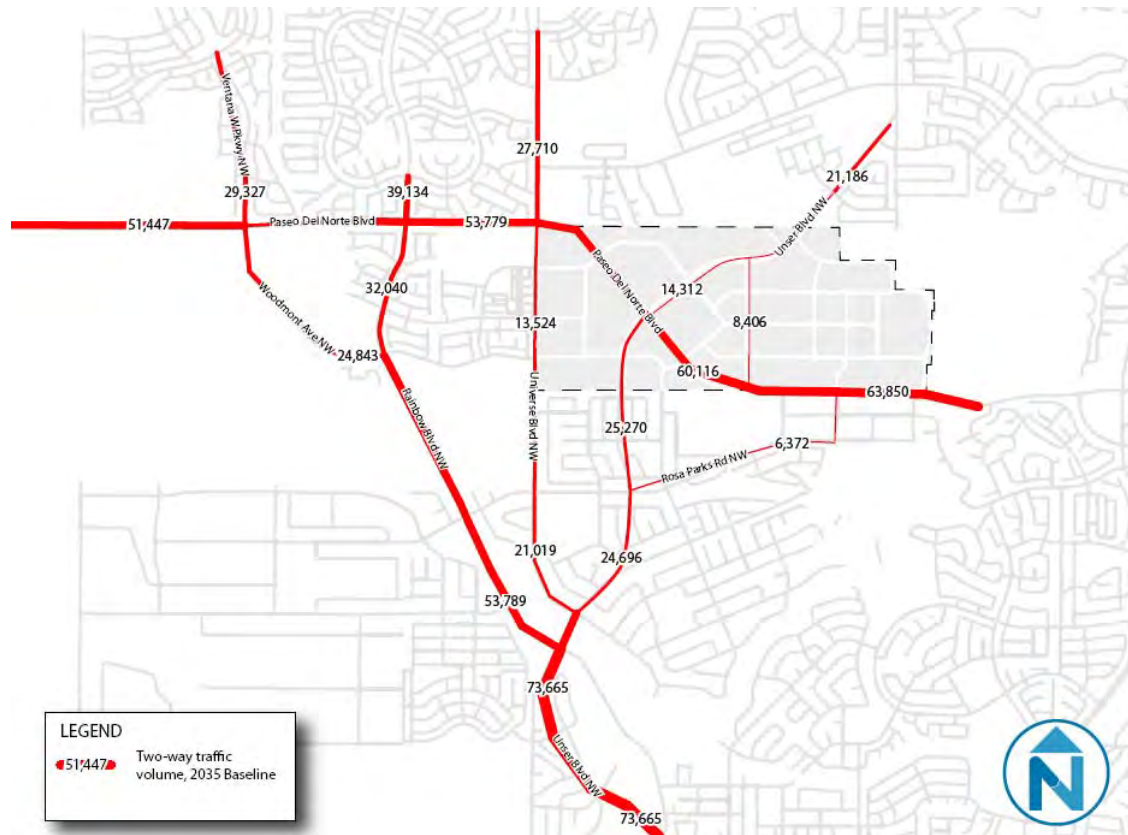

Trips to/from Volcano Heights

Unlike the existing zoning, the land use strategy in the 2012 VHSDP allows mixed-use development, with residences and services within walking or biking distance of each other. This development is intended to serve new residents, nearby residents, as well as regional markets. VHSDP development assumptions for Year 2035 were based on the allowable land uses, as described in the VHSDP, and a market assessment of future demand for office and retail space in the area within the specified timeframe. Based on that assessment, City Planning staff provided the following forecast of Year 2035 land uses:

- 2 million square feet of commercial space including:
 - 1.2 million square feet of office space
 - 800,000 square feet of retail space (mix of regional-serving, local-serving and specialty retail uses)
- 4,769 residential dwelling units consisting of:
 - 4,114 multi-family dwellings
 - 364 single-family detached dwellings
 - 291 single-family attached (rowhouse, townhouse, or duplex) dwellings

Sector Plan Traffic Generation

The steps undertaken to provide a preliminary vehicle trip forecast for proposed Year 2035 land uses under the VHSDP are described below.

Step 1: ITE Baseline Trip Generation

The baseline forecast of trips that would be generated by the Year 2035 land uses within the VHSDP boundaries was derived using trip generation rates for the key land use types provided by the Institute of Transportation Engineers (ITE) *Trip Generation Manual*, 8th edition.

ITE trip generation rates are based on studies of suburban locations, typically “single-use” developments. Such developments typically are located in areas with minimal public transit service and minimal provisions for pedestrian and bicycle circulation. Land uses selected for observation also generally provide separate, free parking facilities for each land use, and nearly all trips to and from such sites are made via private motor vehicle.

ITE chose to collect data at single-use suburban sites precisely to provide a “baseline” forecast of traffic generation that should be adjusted based on local characteristics and site-specific factors, such as:

- Rates of transit ridership and service
- Provisions for pedestrian and bicycle circulation
- Density and mix of land uses, particularly relevant to mixed-use developments, as envisioned in the VHSDP, in which a portion of trips will occur internally, between the various land uses within the sector

Since the baseline trip generation rates for individual land uses are based on data collected at low density development with separated land uses and minimal transit, walking, or biking, ITE cautions that trip generation analysis using ITE rates as a “baseline” must take into account land use and transportation alternatives from the local context in order to be accurate.

The methodology for applying site-specific trip generation factors based on the proposed mix of land uses and proposed street network configuration is described in Steps 2, 3 and 4.

Step 2: Baseline Trip Adjustment to Avoid Double-counting of Internal Trips

Adjustment to account for internal trips to/from retail uses that would otherwise be double-counted, based on ITE internal trip capture data for retail uses (to/from office, residential and other retail uses) in mixed-use developments.

Step 3: Baseline Trip Adjustment to Account for Retail Pass-by Trips

A significant portion of retail trips are “pass-by” trips. Pass-by trip rates are often between 20 and 50 percent of retail trips, generally higher for smaller retail establishments.

This forecast applied a PM Peak Hour pass-by rate of 25 percent for PM Peak derived from ITE logarithm for Shopping Centers applied to the anticipated size of regional retail sites within VH (determined at the block level). Daily pass-by rate conservatively estimated at 15 percent.

Step 4: Bicycle & Walking Trips

The proposed development will have a relatively dense street network, a mix of land uses in close proximity, and street designs that incorporate facilities for bicycle, pedestrian and transit users. Residents and employees living and working in Volcano Heights will have some transportation choice - where different modes may be more convenient at different times, depending on the trip.

Since the ITE average trip generation rates are based on observations made at single-use sites, the ITE average rates will not accurately predict the level of trip generation that would result from the proposed mix of uses at Volcano Heights. Therefore, consistent with the ITE recommended practice, the ITE average rates were adjusted based on local conditions, including the proposed mix of land use types.

To estimate the effect of the proposed mix-use development pattern on trip generation, Nelson\Nygaard utilized the URBEMIS methodology. URBEMIS is a program developed for the California Air Resources Board to calculate vehicle trips and resulting emissions, resulting from new development.

- URBEMIS was developed to more accurately reflect the level of vehicle trip generation resulting from new development, by providing formulas based on specific site characteristics. URBEMIS calculates trip generation rates using the ITE average trip generation rates as a “base.”
- The URBEMIS methodology is designed to offer a useful comparison of the difference in trip generation that can be expected when locating high density development in mixed-use high-density areas with alternative transportation modes available and/or transportation demand management programs in place.

The URBEMIS method employs standard methodologies but provides the opportunity to adjust ITE average rates to quantify the impact of a development’s location, physical characteristics and any demand management programs. In this way, it provides an opportunity to fairly evaluate developments that minimize their transportation impact, for example, through locating close to transit or providing high densities and a mix of uses.

Area Inputs

In addition to requiring the transportation modeler to input the basic land use components of the proposed project (i.e. the number of square feet of each land use), URBEMIS also factors in other area-specific characteristics to determine accurate trip rates. The number of trips generated by a development depends not only on the characteristics of the project itself, but also on the nature of the surrounding area. For example, neighborhood characteristics such as a good balance of housing and jobs, the presence of frequent transit service, and a highly-connected, walkable street network are strongly associated with lower vehicle trip rates. High-density housing added to an existing central city neighborhood, where many shops, services and transit lines already exist, will normally generate fewer trips than the same housing located close to a freeway interchange and surrounded by only low-density housing subdivisions. For this reason, URBEMIS requires data about the area within approximately a half-mile radius from the center of the project, or for the entire project area, whichever is larger. Figure 1-10 shows the key project area characteristics applicable to the URBEMIS methodology.

Area Characteristics Input to URBEMIS Model

Factors
Number of housing units within ½ mile radius
Number of jobs located within ½ mile radius
Local serving retail within ½ mile radius
Transit service
Intersection density within ½ mile radius*
Sidewalk completeness within ½ mile radius
Bike lane completeness within ½ mile radius

Note: * Calculated from proposed street network, based on the number line segment terminations, or each "valence". Intersections have a valence of 3 or higher - a valence of 3 is a "T" intersection, 4 is a four-way intersection, and so on.

It is important to note that the above characteristics do not incorporate any transportation demand management (TDM) measures, such as specific programs, incentives or strategies to reduce trip generation. Rather, they are based entirely on the mix and density of land uses, and the proposed design of the road network.

Step 5: Transit Trip Forecast

For planning purposes, a preliminary "back-of-the-envelope" estimate of potential transit ridership was incorporated into this forecast, which assumed a relatively modest level of transit ridership, 5% of home to work trips for both residential and non-residential land uses, plus daily "non-work" transit trips estimated at 50% of daily work trips by transit. Higher levels of transit ridership are ultimately feasible depending on the ultimate level of transit service and transit incentives.

Step 6: Vehicle Trip Forecast

The resulting vehicle trip forecast is shown on Figure 1-11 for Volcano Heights, while a comparative trip generation forecast based on Conceptual Plan land uses, based on the same methodology, is shown on Figure 1-12.

Volcano Heights SDP: Proposed Intersection Spacing
City of Albuquerque Planning Department – June 6, 2013

Trip Generation Forecast: Volcano Heights Sector Development Plan (Year 2035)

Land Use	No. Units	Trip Generation Rate (see note 1)				Total Trips		
		Daily	AM Peak	PM Peak	Units	Daily	AM Peak	PM Peak
Residential								
Detached	364 (units)	9.57	0.77	1.02	/unit	3,483	280	504
Attached	291 (units)	5.81	0.44	0.52	/unit	1,691	128	151
Multifamily	4,114 (units)	6.65	0.51	0.62	/unit	27,360	2,098	2,551
Hotel	53,600 (ft ²)	8.92	0.64	0.74	/occupied room	797	57	66
Office	1,180,135 (ft ²)	11.01	1.55	1.49	/1,000 ft ²	12,993	1,829	1,758
Retail								
Regional Retail	326,700 (ft ²)	42.94	1.95	7.70	/1,000 ft ²	14,028	638	2,515
Specialty Retail	322,198 (ft ²)	44.32	6.84	5.02	/1,000 ft ²	14,280	2,204	1,617
Local Retail	170,600 (ft ²)	42.94	3.72	12.92	/1,000 ft ²	7,326	635	2,205
<i>Internal Trip Adjustment (see note 2)</i>		-19%	-15%	-20%		-15,679	-1,181	-2,218
<i>Retail Pass-by Trips (see note 3)</i>		-15%	-15%	-25%		-5,345	-522	-1,584
Base Trip Subtotal (VH Sector Development Plan)						60,935	6,168	7,565
<i>Walk & Bicycle Trips (see note 4)</i>		15%	14%	20%		9,070	836	1,550
<i>Transit Trips (see note 5)</i>		3%	5%	4%		2,000	300	300
Total Vehicle Trips Generated						49,865	5,032	5,715
<i>Internal Vehicle Trips (see note 6)</i>		13%	7%	11%		6,509	330	653
<i>External Vehicle Trips (see note 7)</i>		87%	93%	89%		43,356	4,702	5,062
Notes:								
(1) Base trip rates from ITE Trip Generation, 8th Edition. Peak hour trips rates shown for Regional Retail and Local Retail based on fitted curve logarithm applied at block level.								
(2) Adjustment to account for internal trips to/from retail uses that would otherwise be double-counted, based on ITE internal trip capture data for retail uses (to/from office, residential and other retail uses) in mixed-use developments.								
(3) Pass-by rate of 25 percent for PM Peak derived from ITE logarithm for Shopping Centers (while local and specialty retail uses often have higher pass-by rates). Daily pass-by rate conservatively estimated at 15 percent.								
(4) Mode shift for internal trips based on proposed density, mix of uses, block layout, bicycle and pedestrian facilities								
(5) Based on preliminary "back-of-the-envelope" estimate of potential transit ridership. Assumed 5% of home to work trips for both residential and non-residential land uses would occur via transit plus estimated "non-work" transit trips at 50% of								
(6) Total Vehicle Trips derived by subtracting walk & bicycle trips (see note 4) and transit trips (see note 5) from Base Trip Subtotal.								
(7) Derived from estimated internal trips (see note 2), subtracting internal walk & bicycle trips (see note 4) and internal transit trips (estimated at 5% of transit ridership).								
(8) Net vehicle trips derived by subtracting internal vehicle trips (see note 6) from total vehicle trips generated.								

INTERSECTION LEVEL OF SERVICE

Tables 1-1 and 1-2 provide a comparison of intersection level of service (LOS) at signalized intersections. As shown:

- **Failing LOS E would be anticipated under Year 2035 PM Peak Hour conditions at Paseo del Norte & Unser and at Paseo del Norte & Kimmick under Scheme B** (the “baseline” scenario with currently allowed full-access intersections and assumed right-in/right-out intersections at least ¼ mile apart).
- **Acceptable LOS D or C would be achieved at all under intersections under Schemes A, C and D**, due to greater dispersal of movements in & out of VH to multiple intersections. (As noted previously: 40 percent of trips on Paseo del Norte and Unser will be to/from VH land uses).

The LOS analysis was conducted using SYNCHRO 8 software, which evaluates delay taking into account upstream/downstream signal coordination. So for instance: the arrival pattern of traffic platoons (at specific points in each signal cycle) has an effect on average delay.

SIGNAL PROGRESSION & CORRIDOR TRAVEL TIMES

Appendix B provides signal phasing reports, showing the assumed signal phasing at each intersection with 120-second cycles.

- Shorter cycles, while desirable, would not likely be feasible given the size of the intersections, lengthy pedestrian crossing distances (and required crossing times), and conflicting movements (i.e., left-turn phases).

Tables 2-1 and 2-2 provide a comparison of average travel speeds on Paseo del Norte and Unser with the assumed signal progression plan. (Also see Appendix C, Arterial Level of Service reports).

As shown:

- Baseline average travel speed (under Scheme B) would be 25 mph on Unser, and 23 on Paseo del Norte, based on Year 2035 Peak Hour volumes.
- **The net change in travel speed, for “through trips”, under Schemes A, C and D would be approximately 3 mph on Unser, and 1 mph on Paseo del Norte.**
- Based on the predicted net change: the added travel time for through trips would be approximately 15 seconds on both Paseo del Norte (1.5 miles) and Unser (1 mile).
- However, net travel time for trips to/from Volcano Heights would be **reduced** significantly due to the provision of direct access to future employment, services and housing (serving up to 40 percent of trips on Paseo del Norte & Unser).

Volcano Heights SDP: Proposed Intersection Spacing
 City of Albuquerque Planning Department – June 6, 2013

Table 1-1 Level of Service Comparison: Schemes A, B, C, and D

Year 2025 Intersection Level of Service (LOS) PM Peak Hour	Scheme A: VHSDP		Scheme B: Policy		Scheme C: Compromise		Scheme D: Final Request	
	LOS	Avg Delay (seconds)	LOS	Avg Delay (seconds)	LOS	Avg Delay (seconds)	LOS	Avg Delay (seconds)
<i>Paseo del Norte Intersections</i>								
Universe	C	25	C	25	C	25	C	25
Loop Rd -- WEST (proposed –1500' west of Unser)	C	27			C	27	C	27
Unser	D	40	E	58	D	39	D	40
Avenida de Jaimito + Loop Rd East (proposed – 1186' to 1500' east of Unser)	C	34			C	34	C	31
Transit Blvd. (with signalized T-intersection on Paseo del Norte)							A	6
Kimmick Rd	C	34	E	57	D	35	C	32
<i>Unser Boulevard Intersections</i>								
Loop Road – South Intersection (proposed 1000' to 1700' south of Paseo del Norte)	B	16			B	16	B	16
Paseo del Norte	D	40	E	58	D	40	D	40
Loop Road – North Intersection (proposed 1400' north of Unser)	B	16			B	16	B	16
Transit Blvd (2700' north of Paseo del Norte)	C	24	C	28	C	27	C	24
Note: Bold indicates failing level of service (LOS E or worse).								

Volcano Heights SDP: Proposed Intersection Spacing
 City of Albuquerque Planning Department – June 6, 2013

Table 2-1: Travel Speed Comparison (Schemes A, B, C, and D)

Travel Speed Comparison Motor Vehicle Trips through Volcano Heights PM Peak Hour (Year 2035 Volumes)	Scheme A: VHSDP	Scheme B: Policy	Scheme C: Compromise	Scheme D: Final Request
<i>Paseo del Norte</i>				
Eastbound	25 mph	29 mph	24 mph	24 mph
Westbound	20 mph	19 mph	22 mph	20 mph
Overall	22 mph	23 mph	22 mph	22 mph
<i>Unser Boulevard</i>				
Northbound	23 mph	23 mph	21 mph	23 mph
Southbound	21 mph	28 mph	23 mph	21 mph
Overall	22 mph	25 mph	23 mph	22 mph

Appendix A

Synchro Outputs: Travel Speed & Level of Service

Paseo del Norte

























Direction	EB	WB	All
Average Speed (mph)	25	20	22
Total Travel Time (hr)	229	297	525
Distance Traveled (mi)	5629	6070	11699
Performance Index	124.5	188.1	312.6

Unser Blvd

Direction	EB	NB	SW	All
Average Speed (mph)	24	23	21	22
Total Travel Time (hr)	11	58	65	134
Distance Traveled (mi)	267	1301	1392	2959
Performance Index	6.6	37.2	43.1	87.0

























HCM 2010 Signalized Intersection Summary
 11: Universe & Paseo del Norte

Scheme A -- Year 2035 PM
 6/1/2013

												
Movement	EBL	EBT	EBR	WBL	WBT	WBR	NBL	NBT	NBR	SBL	SBT	SBR
Lane Configurations												
Volume (veh/h)	150	1832	54	100	2101	250	104	500	50	150	400	150
Number	7	4	14	3	8	18	5	2	12	1	6	16
Initial Q (Qb), veh	0	0	0	0	0	0	0	0	0	0	0	0
Ped-Bike Adj(A_pbT)	1.00		1.00	1.00		1.00	1.00		1.00	1.00		1.00
Parking Bus Adj	1.00	1.00	1.00	1.00	1.00	1.00	1.00	1.00	1.00	1.00	1.00	1.00
Adj Sat Flow veh/h/ln	186.3	186.3	186.3	186.3	186.3	186.3	186.3	186.3	186.3	186.3	186.3	186.3
Lanes	2	3	1	2	3	1	2	2	1	2	2	1
Cap, veh/h	212	2847	807	157	2730	774	160	736	313	212	792	337
Arrive On Green	0.06	0.51	0.51	0.05	0.49	0.49	0.09	0.39	0.39	0.06	0.21	0.21
Sat Flow, veh/h	3442	5588	1583	3442	5588	1583	3442	3725	1583	3442	3725	1583
Grp Volume(v), veh/h	150	1832	54	100	2101	250	104	500	50	150	400	150
Grp Sat Flow(s),veh/h/ln	1721	1863	1583	1721	1863	1583	1721	1863	1583	1721	1863	1583
Q Serve(g_s), s	4.4	24.5	1.8	2.9	31.5	6.8	3.0	11.4	2.1	4.4	9.7	6.7
Cycle Q Clear(g_c), s	4.4	24.5	1.8	2.9	31.5	6.8	3.0	11.4	2.1	4.4	9.7	6.7
Prop In Lane	1.00		1.00	1.00		1.00	1.00		1.00	1.00		1.00
Lane Grp Cap(c), veh/h	212	2847	807	157	2730	774	160	736	313	212	792	337
V/C Ratio(X)	0.71	0.64	0.07	0.64	0.77	0.32	0.65	0.68	0.16	0.71	0.51	0.45
Avail Cap(c_a), veh/h	235	2847	807	235	2730	774	235	1347	572	235	1347	572
HCM Platoon Ratio	1.00	1.00	1.00	1.00	1.00	1.00	2.00	2.00	2.00	1.00	1.00	1.00
Upstream Filter(I)	1.00	1.00	1.00	0.65	0.65	0.65	1.00	1.00	1.00	1.00	1.00	1.00
Uniform Delay (d), s/veh	47.1	18.3	12.7	48.0	21.4	7.7	45.6	28.3	25.5	47.1	35.5	22.3
Incr Delay (d2), s/veh	8.3	0.5	0.0	2.8	1.4	0.7	4.4	1.1	0.2	8.3	0.5	0.9
Initial Q Delay(d3),s/veh	0.0	0.0	0.0	0.0	0.0	0.0	0.0	0.0	0.0	0.0	0.0	0.0
%ile Back of Q (50%), veh/ln	2.2	10.6	0.6	1.3	14.0	2.4	1.3	4.4	0.8	2.2	4.5	2.6
Lane Grp Delay (d), s/veh	55.4	18.8	12.8	50.8	22.9	8.5	49.9	29.4	25.7	55.4	36.0	23.2
Lane Grp LOS	E	B	B	D	C	A	D	C	C	E	D	C
Approach Vol, veh/h		2036			2451			654			700	
Approach Delay, s/veh		21.4			22.5			32.4			37.4	
Approach LOS		C			C			C			D	
Timer												
Assigned Phs	7	4		3	8		5	2		1	6	
Phs Duration (G+Y+Rc), s	11.3	57.1		9.2	55.0		9.3	25.2		10.8	26.8	
Change Period (Y+Rc), s	5.0	5.0		4.5	5.0		4.5	5.0		4.5	5.0	
Max Green Setting (Gmax), s	7.0	50.0		7.0	50.0		7.0	37.0		7.0	37.0	
Max Q Clear Time (g_c+I1), s	6.4	26.5		4.9	33.5		5.0	13.4		6.4	11.7	
Green Ext Time (p_c), s	0.0	14.9		0.0	12.9		0.0	6.9		0.0	7.0	
Intersection Summary												
HCM 2010 Ctrl Delay			25.0									
HCM 2010 LOS			C									
Notes												

HCM 2010 Signalized Intersection Summary
 12: Unser Blvd & Paseo del Norte

Scheme A -- Year 2035 PM
 6/1/2013

												
Movement	SEL	SET	SER	NWL	NWT	NWR	NEL	NET	NER	SWL	SWT	SWR
Lane Configurations												
Volume (veh/h)	100	1900	109	150	2411	100	150	905	200	150	792	150
Number	7	4	14	3	8	18	5	2	12	1	6	16
Initial Q (Qb), veh	0	0	0	0	0	0	0	0	0	0	0	0
Ped-Bike Adj(A_pbT)	1.00		0.98	1.00		0.98	0.99		0.97	1.00		0.97
Parking Bus Adj	1.00	1.00	1.00	1.00	1.00	1.00	1.00	1.00	1.00	1.00	1.00	1.00
Adj Sat Flow veh/h/ln	186.3	186.3	186.3	186.3	186.3	186.3	186.3	186.3	186.3	186.3	186.3	186.3
Lanes	2	3	1	2	3	1	2	2	1	2	2	1
Cap, veh/h	155	2222	615	210	2311	715	498	1184	585	386	1183	560
Arrive On Green	0.05	0.40	0.40	0.06	0.41	0.41	0.05	0.32	0.32	0.09	0.64	0.64
Sat Flow, veh/h	3442	5588	1547	3442	5588	1549	3442	3725	1538	3442	3725	1538
Grp Volume(v), veh/h	100	1900	109	150	2411	100	150	905	200	150	792	150
Grp Sat Flow(s),veh/h/ln	1721	1863	1547	1721	1863	1549	1721	1863	1538	1721	1863	1538
Q Serve(g_s), s	3.2	35.1	5.2	4.8	46.8	4.2	3.3	24.8	10.5	3.3	15.3	4.7
Cycle Q Clear(g_c), s	3.2	35.1	5.2	4.8	46.8	4.2	3.3	24.8	10.5	3.3	15.3	4.7
Prop In Lane	1.00		1.00	1.00		1.00	1.00		1.00	1.00		1.00
Lane Grp Cap(c), veh/h	155	2222	615	210	2311	715	498	1184	585	386	1183	560
V/C Ratio(X)	0.65	0.86	0.18	0.72	1.04	0.14	0.30	0.76	0.34	0.39	0.67	0.27
Avail Cap(c_a), veh/h	304	2222	615	304	2311	715	579	1218	599	468	1218	574
HCM Platoon Ratio	1.00	1.00	1.00	1.00	1.00	1.00	1.00	1.00	1.00	2.00	2.00	2.00
Upstream Filter(I)	0.62	0.62	0.62	0.39	0.39	0.39	0.72	0.72	0.72	0.92	0.92	0.92
Uniform Delay (d), s/veh	53.2	31.1	22.1	52.2	33.2	17.6	25.1	34.8	25.1	25.7	16.9	13.1
Incr Delay (d2), s/veh	2.8	2.9	0.4	1.8	25.1	0.2	0.2	2.1	0.2	0.6	1.3	0.2
Initial Q Delay(d3),s/veh	0.0	0.0	0.0	0.0	0.0	0.0	0.0	0.0	0.0	0.0	0.0	0.0
%ile Back of Q (50%), veh/ln	1.5	16.4	2.0	2.2	26.3	1.5	1.4	11.8	3.9	1.3	4.7	1.5
Lane Grp Delay (d), s/veh	55.9	34.0	22.5	54.0	58.3	17.8	25.3	36.9	25.4	26.3	18.1	13.3
Lane Grp LOS	E	C	C	D	F	B	C	D	C	C	B	B
Approach Vol, veh/h		2109			2661			1255			1092	
Approach Delay, s/veh		34.4			56.6			33.7			18.6	
Approach LOS		C			E			C			B	
Timer												
Assigned Phs	7	4		3	8		5	2		1	6	
Phs Duration (G+Y+Rc), s	10.1	50.0		11.9	51.8		10.3	41.0		10.3	41.0	
Change Period (Y+Rc), s	5.0	5.0		5.0	5.0		5.0	5.0		5.0	5.0	
Max Green Setting (Gmax), s	10.0	45.0		10.0	45.0		8.0	37.0		8.0	37.0	
Max Q Clear Time (g_c+I1), s	5.2	37.1		6.8	48.8		5.3	26.8		5.3	17.3	
Green Ext Time (p_c), s	0.1	7.8		0.1	0.0		0.1	7.5		0.1	12.2	
Intersection Summary												
HCM 2010 Ctrl Delay			40.1									
HCM 2010 LOS			D									
Notes												

HCM 2010 Signalized Intersection Summary
 13: Kimmick Rd & Paseo del Norte

Scheme A -- Year 2035 PM
 6/1/2013

Movement	EBL	EBT	EBR	WBL	WBT	WBR	NBL	NBT	NBR	SBL	SBT	SBR
Lane Configurations												
Volume (veh/h)	177	1968	100	200	2456	286	141	150	193	150	150	172
Number	7	4	14	3	8	18	5	2	12	1	6	16
Initial Q (Qb), veh	0	0	0	0	0	0	0	0	0	0	0	0
Ped-Bike Adj(A_pbT)	1.00		0.99	1.00		0.99	0.99		0.98	0.99		0.98
Parking Bus Adj	1.00	1.00	1.00	1.00	1.00	1.00	1.00	1.00	1.00	1.00	1.00	1.00
Adj Sat Flow veh/h/ln	186.3	186.3	186.3	186.3	186.3	193.7	186.3	186.3	186.3	186.3	186.3	186.3
Lanes	2	3	1	2	3	1	1	1	1	2	1	1
Cap, veh/h	246	2501	702	270	2540	741	326	429	357	631	429	357
Arrive On Green	0.07	0.45	0.45	0.08	0.45	0.45	0.05	0.23	0.23	0.05	0.23	0.23
Sat Flow, veh/h	3442	5588	1567	3442	5588	1630	1774	1863	1552	3442	1863	1552
Grp Volume(v), veh/h	177	1968	100	200	2456	286	141	150	193	150	150	172
Grp Sat Flow(s),veh/h/ln	1721	1863	1567	1721	1863	1630	1774	1863	1552	1721	1863	1552
Q Serve(g_s), s	5.2	30.8	3.9	5.8	43.8	11.9	5.0	6.9	11.2	3.4	6.9	9.8
Cycle Q Clear(g_c), s	5.2	30.8	3.9	5.8	43.8	11.9	5.0	6.9	11.2	3.4	6.9	9.8
Prop In Lane	1.00		1.00	1.00		1.00	1.00		1.00	1.00		1.00
Lane Grp Cap(c), veh/h	246	2501	702	270	2540	741	326	429	357	631	429	357
V/C Ratio(X)	0.72	0.79	0.14	0.74	0.97	0.39	0.43	0.35	0.54	0.24	0.35	0.48
Avail Cap(c_a), veh/h	403	2508	704	403	2540	741	326	672	560	631	672	560
HCM Platoon Ratio	1.00	1.00	1.00	1.00	1.00	1.00	1.00	1.00	1.00	1.00	1.00	1.00
Upstream Filter(I)	1.00	1.00	1.00	1.00	1.00	1.00	1.00	1.00	1.00	1.00	1.00	1.00
Uniform Delay (d), s/veh	46.6	24.1	16.7	46.2	27.2	18.5	30.5	33.0	34.7	28.1	33.0	34.2
Incr Delay (d2), s/veh	3.9	2.6	0.4	4.0	11.7	1.5	0.9	0.5	1.3	0.2	0.5	1.0
Initial Q Delay(d3),s/veh	0.0	0.0	0.0	0.0	0.0	0.0	0.0	0.0	0.0	0.0	0.0	0.0
%ile Back of Q (50%), veh/ln	2.4	14.1	1.5	2.7	21.6	4.8	0.8	3.3	4.4	1.5	3.3	3.8
Lane Grp Delay (d), s/veh	50.5	26.7	17.1	50.2	38.9	20.0	31.5	33.5	36.0	28.3	33.5	35.2
Lane Grp LOS	D	C	B	D	D	C	C	C	D	C	C	D
Approach Vol, veh/h		2245			2942			484			472	
Approach Delay, s/veh		28.2			37.8			33.9			32.5	
Approach LOS		C			D			C			C	
Timer												
Assigned Phs	7	4		3	8		5	2		1	6	
Phs Duration (G+Y+Rc), s	12.3	50.9		13.0	51.6		10.0	28.6		10.0	28.6	
Change Period (Y+Rc), s	5.0	5.0		5.0	5.0		5.0	5.0		5.0	5.0	
Max Green Setting (Gmax), s	12.0	46.0		12.0	46.0		5.0	37.0		5.0	37.0	
Max Q Clear Time (g_c+I1), s	7.2	32.8		7.8	45.8		7.0	13.2		5.4	11.8	
Green Ext Time (p_c), s	0.2	13.1		0.2	0.2		0.0	3.1		0.0	3.1	
Intersection Summary												
HCM 2010 Ctrl Delay			33.6									
HCM 2010 LOS			C									
Notes												

























HCM 2010 Signalized Intersection Summary
 14: Transit Blvd & Unser Blvd

Scheme A -- Year 2035 PM
 6/1/2013

	→	↘	↙	←	↖	↗
Movement	EBT	EBR	WBL	WBT	NBL	NBR
Lane Configurations	↑↑	↑	↖↗	↑↑	↑	↑
Volume (veh/h)	999	100	182	810	175	309
Number	4	14	3	8	5	12
Initial Q (Qb), veh	0	0	0	0	0	0
Ped-Bike Adj(A_pbT)		0.98	1.00		1.00	1.00
Parking Bus Adj	1.00	1.00	1.00	1.00	1.00	1.00
Adj Sat Flow veh/h/ln	186.3	186.3	186.3	186.3	186.3	186.3
Lanes	2	1	2	2	1	1
Cap, veh/h	1693	708	252	2134	596	532
Arrive On Green	0.45	0.45	0.07	0.57	0.34	0.34
Sat Flow, veh/h	3725	1557	3442	3725	1774	1583
Grp Volume(v), veh/h	999	100	182	810	175	309
Grp Sat Flow(s),veh/h/ln	1863	1557	1721	1863	1774	1583
Q Serve(g_s), s	22.0	4.1	5.7	13.1	8.0	17.7
Cycle Q Clear(g_c), s	22.0	4.1	5.7	13.1	8.0	17.7
Prop In Lane		1.00	1.00		1.00	1.00
Lane Grp Cap(c), veh/h	1693	708	252	2134	596	532
V/C Ratio(X)	0.59	0.14	0.72	0.38	0.29	0.58
Avail Cap(c_a), veh/h	1693	708	563	2134	596	532
HCM Platoon Ratio	1.00	1.00	1.00	1.00	1.00	1.00
Upstream Filter(I)	1.00	1.00	1.00	1.00	1.00	1.00
Uniform Delay (d), s/veh	22.4	17.5	49.9	12.8	26.9	30.1
Incr Delay (d2), s/veh	1.5	0.4	3.9	0.1	1.2	4.6
Initial Q Delay(d3),s/veh	0.0	0.0	0.0	0.0	0.0	0.0
%ile Back of Q (50%), veh/ln	10.2	1.6	2.6	5.4	3.8	7.5
Lane Grp Delay (d), s/veh	23.9	17.9	53.8	12.9	28.1	34.7
Lane Grp LOS	C	B	D	B	C	C
Approach Vol, veh/h	1099			992	484	
Approach Delay, s/veh	23.4			20.4	32.3	
Approach LOS	C			C	C	
Timer						
Assigned Phs	4		3	8		
Phs Duration (G+Y+Rc), s	55.0		13.0	68.0		
Change Period (Y+Rc), s	5.0		5.0	5.0		
Max Green Setting (Gmax), s	50.0		18.0	50.0		
Max Q Clear Time (g_c+I1), s	24.0		7.7	15.1		
Green Ext Time (p_c), s	14.2		0.4	16.5		
Intersection Summary						
HCM 2010 Ctrl Delay			23.9			
HCM 2010 LOS			C			
Notes						

























HCM 2010 Signalized Intersection Summary
 101: Paseo del Norte & Loop Rd W/Loop Rd N

Scheme A -- Year 2035 PM
 6/1/2013

												
Movement	EBL	EBT	EBR	WBL	WBT	WBR	SEL	SET	SER	NWL	NWT	NWR
Lane Configurations												
Volume (veh/h)	114	100	246	133	100	137	131	1730	172	262	2200	250
Number	5	2	12	1	6	16	7	4	14	3	8	18
Initial Q (Qb), veh	0	0	0	0	0	0	0	0	0	0	0	0
Ped-Bike Adj(A_pbT)	0.98		0.98	0.99		0.98	1.00		0.98	1.00		0.99
Parking Bus Adj	1.00	1.00	1.00	1.00	1.00	1.00	1.00	1.00	1.00	1.00	1.00	1.00
Adj Sat Flow veh/h/ln	186.3	186.3	186.3	186.3	186.3	186.3	186.3	186.3	193.7	186.3	186.3	193.7
Lanes	1	1	1	1	1	1	1	3	1	1	3	1
Cap, veh/h	312	490	407	289	490	407	169	2823	815	174	2837	826
Arrive On Green	0.26	0.26	0.26	0.26	0.26	0.26	0.10	0.51	0.51	0.20	1.00	1.00
Sat Flow, veh/h	1121	1863	1547	1017	1863	1547	1774	5588	1614	1774	5588	1627
Grp Volume(v), veh/h	114	100	246	133	100	137	131	1730	172	262	2200	250
Grp Sat Flow(s),veh/h/ln	1121	1863	1547	1017	1863	1547	1774	1863	1614	1774	1863	1627
Q Serve(g_s), s	9.9	4.7	15.6	13.1	4.7	8.0	8.1	24.9	6.6	11.0	0.0	0.0
Cycle Q Clear(g_c), s	14.6	4.7	15.6	17.8	4.7	8.0	8.1	24.9	6.6	11.0	0.0	0.0
Prop In Lane	1.00		1.00	1.00		1.00	1.00		1.00	1.00		1.00
Lane Grp Cap(c), veh/h	312	490	407	289	490	407	169	2823	815	174	2837	826
V/C Ratio(X)	0.36	0.20	0.60	0.46	0.20	0.34	0.77	0.61	0.21	1.51	0.78	0.30
Avail Cap(c_a), veh/h	387	614	510	357	614	510	174	2837	819	174	2837	826
HCM Platoon Ratio	1.00	1.00	1.00	1.00	1.00	1.00	1.00	1.00	1.00	2.00	2.00	2.00
Upstream Filter(I)	1.00	1.00	1.00	1.00	1.00	1.00	0.63	0.63	0.63	0.09	0.09	0.09
Uniform Delay (d), s/veh	37.9	32.2	36.2	39.1	32.2	33.4	49.6	19.9	15.4	45.1	0.0	0.0
Incr Delay (d2), s/veh	0.7	0.2	1.4	1.1	0.2	0.5	12.4	0.2	0.1	231.0	0.2	0.1
Initial Q Delay(d3),s/veh	0.0	0.0	0.0	0.0	0.0	0.0	0.0	0.0	0.0	0.0	0.0	0.0
%ile Back of Q (50%), veh/ln	2.9	2.2	6.1	3.5	2.2	3.1	4.2	11.0	2.5	15.5	0.1	0.0
Lane Grp Delay (d), s/veh	38.6	32.4	37.7	40.3	32.4	33.9	62.0	20.1	15.5	276.1	0.2	0.1
Lane Grp LOS	D	C	D	D	C	C	E	C	B	F	A	A
Approach Vol, veh/h		460			370			2033			2712	
Approach Delay, s/veh		36.8			35.8			22.5			26.8	
Approach LOS		D			D			C			C	
Timer												
Assigned Phs		2			6		7	4		3		8
Phs Duration (G+Y+Rc), s		34.5			34.5		15.7	61.7		16.0		62.0
Change Period (Y+Rc), s		5.0			5.0		5.0	5.0		5.0		5.0
Max Green Setting (Gmax), s		37.0			37.0		11.0	57.0		11.0		57.0
Max Q Clear Time (g_c+I1), s		17.6			19.8		10.1	26.9		13.0		2.0
Green Ext Time (p_c), s		3.2			3.1		0.8	16.6		0.0		31.6
Intersection Summary												
HCM 2010 Ctrl Delay			26.7									
HCM 2010 LOS			C									
Notes												































HCM 2010 Signalized Intersection Summary
 102: Unser Blvd & Loop Rd N

Scheme A -- Year 2035 PM
 6/1/2013

												
Movement	SEL	SET	SER	NWL	NWT	NWR	NEL	NET	NER	SWL	SWT	SWR
Lane Configurations												
Volume (veh/h)	100	100	150	150	100	150	131	850	125	100	791	63
Number	1	6	16	5	2	12	7	4	14	3	8	18
Initial Q (Qb), veh	0	0	0	0	0	0	0	0	0	0	0	0
Ped-Bike Adj(A_pbT)	1.00		1.00	1.00		1.00	1.00		1.00	1.00		1.00
Parking Bus Adj	1.00	1.00	1.00	1.00	1.00	1.00	1.00	1.00	1.00	1.00	1.00	1.00
Adj Sat Flow veh/h/ln	186.3	186.3	186.3	186.3	186.3	186.3	186.3	186.3	186.3	186.3	186.3	186.3
Lanes	1	1	1	1	1	1	1	2	1	1	2	1
Cap, veh/h	261	403	343	261	403	343	458	2568	1091	411	2568	1091
Arrive On Green	0.22	0.22	0.22	0.22	0.22	0.22	0.69	0.69	0.69	0.69	0.69	0.69
Sat Flow, veh/h	1125	1863	1583	1125	1863	1583	644	3725	1583	574	3725	1583
Grp Volume(v), veh/h	100	100	150	150	100	150	131	850	125	100	791	63
Grp Sat Flow(s),veh/h/ln	1125	1863	1583	1125	1863	1583	644	1863	1583	574	1863	1583
Q Serve(g_s), s	8.6	4.7	8.7	13.5	4.7	8.7	10.7	9.7	2.8	9.0	8.9	1.4
Cycle Q Clear(g_c), s	13.3	4.7	8.7	18.2	4.7	8.7	19.6	9.7	2.8	18.7	8.9	1.4
Prop In Lane	1.00		1.00	1.00		1.00	1.00		1.00	1.00		1.00
Lane Grp Cap(c), veh/h	261	403	343	261	403	343	458	2568	1091	411	2568	1091
V/C Ratio(X)	0.38	0.25	0.44	0.57	0.25	0.44	0.29	0.33	0.11	0.24	0.31	0.06
Avail Cap(c_a), veh/h	411	651	553	411	651	553	458	2568	1091	411	2568	1091
HCM Platoon Ratio	1.00	1.00	1.00	1.00	1.00	1.00	1.00	1.00	1.00	1.00	1.00	1.00
Upstream Filter(I)	1.00	1.00	1.00	1.00	1.00	1.00	0.53	0.53	0.53	1.00	1.00	1.00
Uniform Delay (d), s/veh	39.9	34.4	35.9	41.9	34.4	35.9	10.4	6.6	5.6	10.4	6.5	5.3
Incr Delay (d2), s/veh	0.9	0.3	0.9	2.0	0.3	0.9	0.8	0.2	0.1	1.4	0.3	0.1
Initial Q Delay(d3),s/veh	0.0	0.0	0.0	0.0	0.0	0.0	0.0	0.0	0.0	0.0	0.0	0.0
%ile Back of Q (50%), veh/ln	2.5	2.3	3.5	4.0	2.3	3.5	1.6	3.7	0.9	1.3	3.4	0.5
Lane Grp Delay (d), s/veh	40.8	34.7	36.8	43.9	34.7	36.8	11.2	6.8	5.7	11.8	6.8	5.4
Lane Grp LOS	D	C	D	D	C	D	B	A	A	B	A	A
Approach Vol, veh/h		350			400			1106			954	
Approach Delay, s/veh		37.3			38.9			7.2			7.2	
Approach LOS		D			D			A			A	
Timer												
Assigned Phs		6			2			4			8	
Phs Duration (G+Y+Rc), s		27.9			27.9			78.0			78.0	
Change Period (Y+Rc), s		5.0			5.0			5.0			5.0	
Max Green Setting (Gmax), s		37.0			37.0			73.0			73.0	
Max Q Clear Time (g_c+I1), s		15.3			20.2			21.6			20.7	
Green Ext Time (p_c), s		2.9			2.7			19.0			19.1	
Intersection Summary												
HCM 2010 Ctrl Delay			15.5									
HCM 2010 LOS			B									
Notes												

























HCM 2010 Signalized Intersection Summary
 103: Avenita de Jaimito/Loop Rd East & Paseo del Norte

Scheme A -- Year 2035 PM
 6/1/2013

												
Movement	SEL	SET	SER	NWL	NWT	NWR	NEL	NET	NER	SWL	SWT	SWR
Lane Configurations	 	  		 	  							 
Volume (veh/h)	200	1800	250	262	2233	343	135	100	272	178	100	293
Number	7	4	14	3	8	18	5	2	12	1	6	16
Initial Q (Qb), veh	0	0	0	0	0	0	0	0	0	0	0	0
Ped-Bike Adj(A_pbT)	1.00		0.99	1.00		0.99	0.99		0.98	0.99		0.98
Parking Bus Adj	1.00	1.00	1.00	1.00	1.00	1.00	1.00	1.00	1.00	1.00	1.00	1.00
Adj Sat Flow veh/h/ln	167.6	167.6	174.4	167.6	167.6	174.4	167.6	167.6	167.6	167.6	167.6	167.6
Lanes	2	3	1	2	3	1	1	1	1	1	1	1
Cap, veh/h	316	2386	694	314	2384	693	282	495	412	286	495	412
Arrive On Green	0.10	0.47	0.47	0.10	0.47	0.47	0.29	0.29	0.29	0.29	0.29	0.29
Sat Flow, veh/h	3097	5029	1463	3097	5029	1463	879	1676	1396	895	1676	1396
Grp Volume(v), veh/h	200	1800	250	262	2233	343	135	100	272	178	100	293
Grp Sat Flow(s),veh/h/ln	1549	1676	1463	1549	1676	1463	879	1676	1396	895	1676	1396
Q Serve(g_s), s	7.2	34.0	12.6	9.6	48.8	18.7	15.8	5.2	19.8	21.6	5.2	21.7
Cycle Q Clear(g_c), s	7.2	34.0	12.6	9.6	48.8	18.7	21.0	5.2	19.8	26.8	5.2	21.7
Prop In Lane	1.00		1.00	1.00		1.00	1.00		1.00	1.00		1.00
Lane Grp Cap(c), veh/h	316	2386	694	314	2384	693	282	495	412	286	495	412
V/C Ratio(X)	0.63	0.75	0.36	0.83	0.94	0.49	0.48	0.20	0.66	0.62	0.20	0.71
Avail Cap(c_a), veh/h	347	2386	694	347	2384	693	303	534	445	307	534	445
HCM Platoon Ratio	1.00	1.00	1.00	1.00	1.00	1.00	1.00	1.00	1.00	1.00	1.00	1.00
Upstream Filter(I)	0.33	0.33	0.33	1.00	1.00	1.00	1.00	1.00	1.00	1.00	1.00	1.00
Uniform Delay (d), s/veh	50.0	25.0	19.3	51.2	28.9	21.0	38.5	30.7	35.8	40.7	30.7	36.5
Incr Delay (d2), s/veh	1.1	0.8	0.5	14.9	8.6	2.5	1.3	0.2	3.3	3.4	0.2	4.8
Initial Q Delay(d3),s/veh	0.0	0.0	0.0	0.0	0.0	0.0	0.0	0.0	0.0	0.0	0.0	0.0
%ile Back of Q (50%), veh/ln	2.9	13.5	4.4	4.4	21.5	7.1	3.7	2.2	7.2	5.3	2.2	8.0
Lane Grp Delay (d), s/veh	51.1	25.7	19.8	66.1	37.5	23.5	39.8	30.9	39.1	44.2	30.9	41.3
Lane Grp LOS	D	C	B	E	D	C	D	C	D	D	C	D
Approach Vol, veh/h		2250			2838			507			571	
Approach Delay, s/veh		27.3			38.4			37.6			40.4	
Approach LOS		C			D			D			D	
Timer												
Assigned Phs	7	4		3	8			2				6
Phs Duration (G+Y+Rc), s	16.8	60.1		16.8	60.0			39.2				39.2
Change Period (Y+Rc), s	5.0	5.0		5.0	5.0			5.0				5.0
Max Green Setting (Gmax), s	13.0	55.0		13.0	55.0			37.0				37.0
Max Q Clear Time (g_c+I1), s	9.2	36.0		11.6	50.8			23.0				28.8
Green Ext Time (p_c), s	2.6	13.4		0.1	3.9			3.7				2.9
Intersection Summary												
HCM 2010 Ctrl Delay			34.5									
HCM 2010 LOS			C									
Notes												

HCM 2010 Signalized Intersection Summary
 104: Unser Blvd & Loop Rd W/Avenida de Jaimito

Scheme A -- Year 2035 PM
 6/1/2013

												
Movement	EBL	EBT	EBR	WBL	WBT	WBR	NBL	NBT	NBR	SBL	SBT	SBR
Lane Configurations												
Volume (veh/h)	50	100	180	180	100	100	121	1105	202	50	800	200
Number	7	4	14	3	8	18	5	2	12	1	6	16
Initial Q (Qb), veh	0	0	0	0	0	0	0	0	0	0	0	0
Ped-Bike Adj(A_pbT)	1.00		1.00	1.00		1.00	1.00		1.00	1.00		1.00
Parking Bus Adj	1.00	1.00	1.00	1.00	1.00	1.00	1.00	1.00	1.00	1.00	1.00	1.00
Adj Sat Flow veh/h/ln	186.3	186.3	186.3	186.3	186.3	186.3	186.3	186.3	186.3	186.3	186.3	186.3
Lanes	1	1	1	1	1	1	1	2	1	1	2	1
Cap, veh/h	435	639	544	410	639	544	316	2059	875	228	2059	875
Arrive On Green	0.34	0.34	0.34	0.34	0.34	0.34	0.55	0.55	0.55	0.55	0.55	0.55
Sat Flow, veh/h	1178	1863	1583	1095	1863	1583	561	3725	1583	419	3725	1583
Grp Volume(v), veh/h	50	100	180	180	100	100	121	1105	202	50	800	200
Grp Sat Flow(s),veh/h/ln	1178	1863	1583	1095	1863	1583	561	1863	1583	419	1863	1583
Q Serve(g_s), s	3.0	3.6	8.1	13.1	3.6	4.3	15.1	18.1	6.3	8.3	11.8	6.2
Cycle Q Clear(g_c), s	6.5	3.6	8.1	16.7	3.6	4.3	26.8	18.1	6.3	26.4	11.8	6.2
Prop In Lane	1.00		1.00	1.00		1.00	1.00		1.00	1.00		1.00
Lane Grp Cap(c), veh/h	435	639	544	410	639	544	316	2059	875	228	2059	875
V/C Ratio(X)	0.11	0.16	0.33	0.44	0.16	0.18	0.38	0.54	0.23	0.22	0.39	0.23
Avail Cap(c_a), veh/h	435	639	544	410	639	544	456	2984	1268	332	2984	1268
HCM Platoon Ratio	1.00	1.00	1.00	1.00	1.00	1.00	1.00	1.00	1.00	1.00	1.00	1.00
Upstream Filter(I)	1.00	1.00	1.00	1.00	1.00	1.00	0.46	0.46	0.46	0.66	0.66	0.66
Uniform Delay (d), s/veh	24.2	21.9	23.4	27.7	21.9	22.1	19.9	13.7	11.0	22.1	12.2	11.0
Incr Delay (d2), s/veh	0.5	0.5	1.6	3.4	0.5	0.7	0.4	0.1	0.1	0.3	0.1	0.1
Initial Q Delay(d3),s/veh	0.0	0.0	0.0	0.0	0.0	0.0	0.0	0.0	0.0	0.0	0.0	0.0
%ile Back of Q (50%), veh/ln	0.9	1.8	3.4	3.9	1.8	1.8	2.0	7.4	2.1	0.9	4.8	2.1
Lane Grp Delay (d), s/veh	24.7	22.4	25.0	31.1	22.4	22.9	20.2	13.8	11.1	22.4	12.3	11.1
Lane Grp LOS	C	C	C	C	C	C	C	B	B	C	B	B
Approach Vol, veh/h		330			380			1428			1050	
Approach Delay, s/veh		24.2			26.6			13.9			12.6	
Approach LOS		C			C			B			B	
Timer												
Assigned Phs		4			8			2			6	
Phs Duration (G+Y+Rc), s		38.0			38.0			58.1			58.1	
Change Period (Y+Rc), s		5.0			5.0			5.0			5.0	
Max Green Setting (Gmax), s		33.0			33.0			77.0			77.0	
Max Q Clear Time (g_c+I1), s		10.1			18.7			28.8			28.4	
Green Ext Time (p_c), s		2.8			2.5			24.3			24.4	
Intersection Summary												
HCM 2010 Ctrl Delay				16.1								
HCM 2010 LOS				B								
Notes												

Paseo del Norte

























Direction	EB	WB	All
Average Speed (mph)	29	19	23
Total Travel Time (hr)	190	332	522
Distance Traveled (mi)	5591	6155	11746
Performance Index	85.1	221.8	306.9

Unser Blvd

Direction	EB	NB	SW	All
Average Speed (mph)	18	24	28	25
Total Travel Time (hr)	11	57	65	133
Distance Traveled (mi)	204	1361	1798	3363
Performance Index	8.4	37.0	34.9	80.3























HCM 2010 Signalized Intersection Summary
 11: Universe & Paseo del Norte

Scheme B -- Year 2035 PM
 6/1/2013

												
Movement	EBL	EBT	EBR	WBL	WBT	WBR	NBL	NBT	NBR	SBL	SBT	SBR
Lane Configurations												
Volume (veh/h)	150	1832	54	100	2101	250	104	500	50	150	400	150
Number	7	4	14	3	8	18	5	2	12	1	6	16
Initial Q (Qb), veh	0	0	0	0	0	0	0	0	0	0	0	0
Ped-Bike Adj(A_pbT)	1.00		1.00	1.00		1.00	1.00		1.00	1.00		1.00
Parking Bus Adj	1.00	1.00	1.00	1.00	1.00	1.00	1.00	1.00	1.00	1.00	1.00	1.00
Adj Sat Flow veh/h/ln	186.3	186.3	186.3	186.3	186.3	186.3	186.3	186.3	186.3	186.3	186.3	186.3
Lanes	2	3	1	2	3	1	2	2	1	2	2	1
Cap, veh/h	212	2847	807	157	2730	774	160	736	313	212	792	337
Arrive On Green	0.06	0.51	0.51	0.05	0.49	0.49	0.09	0.39	0.39	0.06	0.21	0.21
Sat Flow, veh/h	3442	5588	1583	3442	5588	1583	3442	3725	1583	3442	3725	1583
Grp Volume(v), veh/h	150	1832	54	100	2101	250	104	500	50	150	400	150
Grp Sat Flow(s),veh/h/ln	1721	1863	1583	1721	1863	1583	1721	1863	1583	1721	1863	1583
Q Serve(g_s), s	4.4	24.5	1.8	2.9	31.5	6.8	3.0	11.4	2.1	4.4	9.7	6.7
Cycle Q Clear(g_c), s	4.4	24.5	1.8	2.9	31.5	6.8	3.0	11.4	2.1	4.4	9.7	6.7
Prop In Lane	1.00		1.00	1.00		1.00	1.00		1.00	1.00		1.00
Lane Grp Cap(c), veh/h	212	2847	807	157	2730	774	160	736	313	212	792	337
V/C Ratio(X)	0.71	0.64	0.07	0.64	0.77	0.32	0.65	0.68	0.16	0.71	0.51	0.45
Avail Cap(c_a), veh/h	235	2847	807	235	2730	774	235	1347	572	235	1347	572
HCM Platoon Ratio	1.00	1.00	1.00	1.00	1.00	1.00	2.00	2.00	2.00	1.00	1.00	1.00
Upstream Filter(I)	1.00	1.00	1.00	1.00	1.00	1.00	1.00	1.00	1.00	1.00	1.00	1.00
Uniform Delay (d), s/veh	47.1	18.3	12.7	48.0	21.4	7.7	45.6	28.3	25.5	47.1	35.5	22.3
Incr Delay (d2), s/veh	8.3	0.5	0.0	4.2	2.2	1.1	4.4	1.1	0.2	8.3	0.5	0.9
Initial Q Delay(d3),s/veh	0.0	0.0	0.0	0.0	0.0	0.0	0.0	0.0	0.0	0.0	0.0	0.0
%ile Back of Q (50%), veh/ln	2.2	10.6	0.6	1.4	14.2	2.5	1.3	4.4	0.8	2.2	4.5	2.6
Lane Grp Delay (d), s/veh	55.4	18.8	12.8	52.2	23.6	8.8	49.9	29.4	25.7	55.4	36.0	23.2
Lane Grp LOS	E	B	B	D	C	A	D	C	C	E	D	C
Approach Vol, veh/h		2036			2451			654			700	
Approach Delay, s/veh		21.4			23.3			32.4			37.4	
Approach LOS		C			C			C			D	
Timer												
Assigned Phs	7	4		3	8		5	2		1	6	
Phs Duration (G+Y+Rc), s	11.3	57.1		9.2	55.0		9.3	25.2		10.8	26.8	
Change Period (Y+Rc), s	5.0	5.0		4.5	5.0		4.5	5.0		4.5	5.0	
Max Green Setting (Gmax), s	7.0	50.0		7.0	50.0		7.0	37.0		7.0	37.0	
Max Q Clear Time (g_c+I1), s	6.4	26.5		4.9	33.5		5.0	13.4		6.4	11.7	
Green Ext Time (p_c), s	0.0	14.9		0.0	12.9		0.0	6.9		0.0	7.0	
Intersection Summary												
HCM 2010 Ctrl Delay			25.3									
HCM 2010 LOS			C									
Notes												

HCM 2010 Signalized Intersection Summary
 12: Unser Blvd & Paseo del Norte

Scheme B -- Year 2035 PM
 6/1/2013

























												
Movement	SEL	SET	SER	NWL	NWT	NWR	NEU	NEL	NET	NER	SWL	SWT
Lane Configurations												
Volume (veh/h)	281	1725	109	412	2264	100	121	242	814	250	217	658
Number	7	4	14	3	8	18		5	2	12	1	6
Initial Q (Qb), veh	0	0	0	0	0	0		0	0	0	0	0
Ped-Bike Adj(A_pbT)	1.00		0.97	1.00		0.98		0.99		0.97	1.00	
Parking Bus Adj	1.00	1.00	1.00	1.00	1.00	1.00		1.00	1.00	1.00	1.00	1.00
Adj Sat Flow veh/h/ln	186.3	186.3	186.3	186.3	186.3	186.3		186.3	186.3	186.3	186.3	186.3
Lanes	2	3	1	2	3	1		2	2	1	2	2
Cap, veh/h	343	1901	524	439	2056	664		536	1123	665	440	1107
Arrive On Green	0.10	0.34	0.34	0.13	0.37	0.37		0.07	0.30	0.30	0.06	0.30
Sat Flow, veh/h	3442	5588	1541	3442	5588	1545		3442	3725	1536	3442	3725
Grp Volume(v), veh/h	281	1725	109	412	2264	100		242	814	250	217	658
Grp Sat Flow(s),veh/h/ln	1721	1863	1541	1721	1863	1545		1721	1863	1536	1721	1863
Q Serve(g_s), s	9.4	34.7	5.9	14.0	43.3	4.7		5.6	23.0	13.1	5.1	17.7
Cycle Q Clear(g_c), s	9.4	34.7	5.9	14.0	43.3	4.7		5.6	23.0	13.1	5.1	17.7
Prop In Lane	1.00		1.00	1.00		1.00		1.00		1.00	1.00	
Lane Grp Cap(c), veh/h	343	1901	524	439	2056	664		536	1123	665	440	1107
V/C Ratio(X)	0.82	0.91	0.21	0.94	1.10	0.15		0.45	0.72	0.38	0.49	0.59
Avail Cap(c_a), veh/h	439	1901	524	439	2056	664		546	1172	685	465	1172
HCM Platoon Ratio	1.00	1.00	1.00	1.00	1.00	1.00		1.00	1.00	1.00	1.00	1.00
Upstream Filter(I)	1.00	1.00	1.00	1.00	1.00	1.00		1.00	1.00	1.00	1.00	1.00
Uniform Delay (d), s/veh	51.9	37.0	27.6	50.8	37.2	20.5		27.1	36.7	22.9	28.6	35.3
Incr Delay (d2), s/veh	9.3	7.8	0.9	28.1	53.6	0.5		0.6	2.2	0.4	0.9	0.7
Initial Q Delay(d3),s/veh	0.0	0.0	0.0	0.0	0.0	0.0		0.0	0.0	0.0	0.0	0.0
%ile Back of Q (50%), veh/ln	4.5	17.2	2.3	7.8	30.0	1.8		2.4	11.0	4.9	2.2	8.2
Lane Grp Delay (d), s/veh	61.1	44.9	28.5	78.9	90.8	21.0		27.7	38.9	23.2	29.5	36.0
Lane Grp LOS	E	D	C	E	F	C		C	D	C	C	D
Approach Vol, veh/h		2115			2776				1306			1025
Approach Delay, s/veh		46.2			86.5				33.8			32.9
Approach LOS		D			F				C			C
Timer												
Assigned Phs	7	4		3	8			5	2		1	6
Phs Duration (G+Y+Rc), s	16.7	45.0		20.0	48.3			12.7	40.5		12.1	39.9
Change Period (Y+Rc), s	5.0	5.0		5.0	5.0			5.0	5.0		5.0	5.0
Max Green Setting (Gmax), s	15.0	40.0		15.0	40.0			8.0	37.0		8.0	37.0
Max Q Clear Time (g_c+I1), s	11.4	36.7		16.0	45.3			7.6	25.0		7.1	19.7
Green Ext Time (p_c), s	0.3	3.3		0.0	0.0			0.0	7.9		0.1	10.1
Intersection Summary												
HCM 2010 Ctrl Delay				57.6								
HCM 2010 LOS				E								
Notes												



Movement	SWR
Lane Configurations	
Volume (veh/h)	150
Number	16
Initial Q (Qb), veh	0
Ped-Bike Adj(A_pbT)	0.97
Parking Bus Adj	1.00
Adj Sat Flow veh/h/ln	186.3
Lanes	1
Cap, veh/h	614
Arrive On Green	0.30
Sat Flow, veh/h	1535
Grp Volume(v), veh/h	150
Grp Sat Flow(s),veh/h/ln	1535
Q Serve(g_s), s	7.7
Cycle Q Clear(g_c), s	7.7
Prop In Lane	1.00
Lane Grp Cap(c), veh/h	614
V/C Ratio(X)	0.24
Avail Cap(c_a), veh/h	641
HCM Platoon Ratio	1.00
Upstream Filter(l)	1.00
Uniform Delay (d), s/veh	23.7
Incr Delay (d2), s/veh	0.2
Initial Q Delay(d3),s/veh	0.0
%ile Back of Q (50%), veh/ln	2.8
Lane Grp Delay (d), s/veh	23.9
Lane Grp LOS	C
Approach Vol, veh/h	
Approach Delay, s/veh	
Approach LOS	
Timer	
Assigned Phs	
Phs Duration (G+Y+Rc), s	
Change Period (Y+Rc), s	
Max Green Setting (Gmax), s	
Max Q Clear Time (g_c+I1), s	
Green Ext Time (p_c), s	
Intersection Summary	















HCM 2010 Signalized Intersection Summary
 13: Kimmick Rd & Paseo del Norte

Scheme B -- Year 2035 PM
 6/1/2013

												
Movement	EBL	EBT	EBR	WBL	WBT	WBR	NBL	NBT	NBR	SBL	SBT	SBR
Lane Configurations												
Volume (veh/h)	377	1640	100	200	2456	286	141	150	293	378	150	172
Number	7	4	14	3	8	18	5	2	12	1	6	16
Initial Q (Qb), veh	0	0	0	0	0	0	0	0	0	0	0	0
Ped-Bike Adj(A_pbT)	1.00		0.99	1.00		0.99	0.99		0.98	0.99		0.98
Parking Bus Adj	1.00	1.00	1.00	1.00	1.00	1.00	1.00	1.00	1.00	1.00	1.00	1.00
Adj Sat Flow veh/h/ln	186.3	186.3	186.3	186.3	186.3	193.7	186.3	186.3	186.3	186.3	186.3	186.3
Lanes	2	3	1	2	3	1	1	1	1	2	1	1
Cap, veh/h	307	2368	664	260	2292	668	379	484	405	697	484	405
Arrive On Green	0.09	0.42	0.42	0.08	0.41	0.41	0.06	0.26	0.26	0.06	0.26	0.26
Sat Flow, veh/h	3442	5588	1567	3442	5588	1629	1774	1863	1556	3442	1863	1556
Grp Volume(v), veh/h	377	1640	100	200	2456	286	141	150	293	378	150	172
Grp Sat Flow(s),veh/h/ln	1721	1863	1567	1721	1863	1629	1774	1863	1556	1721	1863	1556
Q Serve(g_s), s	10.0	26.9	4.4	6.4	46.0	14.1	6.6	7.3	19.3	7.0	7.3	10.3
Cycle Q Clear(g_c), s	10.0	26.9	4.4	6.4	46.0	14.1	6.6	7.3	19.3	7.0	7.3	10.3
Prop In Lane	1.00		1.00	1.00		1.00	1.00		1.00	1.00		1.00
Lane Grp Cap(c), veh/h	307	2368	664	260	2292	668	379	484	405	697	484	405
V/C Ratio(X)	1.23	0.69	0.15	0.77	1.07	0.43	0.37	0.31	0.72	0.54	0.31	0.43
Avail Cap(c_a), veh/h	307	2368	664	307	2292	668	379	614	513	697	614	513
HCM Platoon Ratio	1.00	1.00	1.00	1.00	1.00	1.00	1.00	1.00	1.00	1.00	1.00	1.00
Upstream Filter(I)	1.00	1.00	1.00	1.00	1.00	1.00	1.00	1.00	1.00	1.00	1.00	1.00
Uniform Delay (d), s/veh	51.1	26.4	19.9	50.9	33.1	23.7	28.2	33.4	37.8	31.0	33.4	34.5
Incr Delay (d2), s/veh	128.2	1.7	0.5	9.6	41.4	2.0	0.6	0.4	3.7	0.9	0.4	0.7
Initial Q Delay(d3),s/veh	0.0	0.0	0.0	0.0	0.0	0.0	0.0	0.0	0.0	0.0	0.0	0.0
%ile Back of Q (50%), veh/ln	9.8	12.4	1.7	3.1	29.6	5.9	3.0	3.5	7.8	1.4	3.5	4.0
Lane Grp Delay (d), s/veh	179.3	28.1	20.4	60.5	74.5	25.7	28.9	33.8	41.5	31.9	33.8	35.2
Lane Grp LOS	F	C	C	E	F	C	C	C	D	C	C	D
Approach Vol, veh/h		2117			2942			584			700	
Approach Delay, s/veh		54.6			68.8			36.5			33.1	
Approach LOS		D			E			D			C	
Timer												
Assigned Phs	7	4		3	8		5	2		1	6	
Phs Duration (G+Y+Rc), s	15.0	52.5		13.5	51.0		12.0	34.2		12.0	34.2	
Change Period (Y+Rc), s	5.0	5.0		5.0	5.0		5.0	5.0		5.0	5.0	
Max Green Setting (Gmax), s	10.0	46.0		10.0	46.0		7.0	37.0		7.0	37.0	
Max Q Clear Time (g_c+I1), s	12.0	28.9		8.4	48.0		8.6	21.3		9.0	12.3	
Green Ext Time (p_c), s	0.0	16.8		0.1	0.0		0.0	3.1		0.0	3.5	
Intersection Summary												
HCM 2010 Ctrl Delay				57.1								
HCM 2010 LOS				E								
Notes												

HCM 2010 Signalized Intersection Summary
 14: Transit Blvd & Unser Blvd

Scheme B -- Year 2035 PM
 6/1/2013

							
Movement	EBU	EBT	EBR	WBL	WBT	NBL	NBR
Lane Configurations							
Volume (veh/h)	131	899	50	182	810	275	459
Number		4	14	3	8	5	12
Initial Q (Qb), veh		0	0	0	0	0	0
Ped-Bike Adj(A_pbT)			0.98	1.00		1.00	1.00
Parking Bus Adj		1.00	1.00	1.00	1.00	1.00	1.00
Adj Sat Flow veh/h/ln		186.3	186.3	186.3	186.3	186.3	186.3
Lanes		2	1	2	2	1	1
Cap, veh/h		1693	708	252	2134	596	532
Arrive On Green		0.45	0.45	0.07	0.57	0.34	0.34
Sat Flow, veh/h		3725	1557	3442	3725	1774	1583
Grp Volume(v), veh/h		899	50	182	810	275	459
Grp Sat Flow(s),veh/h/ln		1863	1557	1721	1863	1774	1583
Q Serve(g_s), s		19.1	2.0	5.7	13.1	13.4	29.8
Cycle Q Clear(g_c), s		19.1	2.0	5.7	13.1	13.4	29.8
Prop In Lane			1.00	1.00		1.00	1.00
Lane Grp Cap(c), veh/h		1693	708	252	2134	596	532
V/C Ratio(X)		0.53	0.07	0.72	0.38	0.46	0.86
Avail Cap(c_a), veh/h		1693	708	563	2134	596	532
HCM Platoon Ratio		1.00	1.00	1.00	1.00	1.00	1.00
Upstream Filter(I)		1.00	1.00	1.00	1.00	1.00	1.00
Uniform Delay (d), s/veh		21.6	16.9	49.9	12.8	28.7	34.1
Incr Delay (d2), s/veh		1.2	0.2	3.9	0.1	2.6	16.7
Initial Q Delay(d3),s/veh		0.0	0.0	0.0	0.0	0.0	0.0
%ile Back of Q (50%), veh/ln		8.8	0.8	2.6	5.4	6.5	13.9
Lane Grp Delay (d), s/veh		22.8	17.1	53.8	12.9	31.2	50.8
Lane Grp LOS		C	B	D	B	C	D
Approach Vol, veh/h		949			992	734	
Approach Delay, s/veh		22.5			20.4	43.5	
Approach LOS		C			C	D	
Timer							
Assigned Phs		4		3	8		
Phs Duration (G+Y+Rc), s		55.0		13.0	68.0		
Change Period (Y+Rc), s		5.0		5.0	5.0		
Max Green Setting (Gmax), s		50.0		18.0	50.0		
Max Q Clear Time (g_c+I1), s		21.1		7.7	15.1		
Green Ext Time (p_c), s		13.8		0.4	15.0		
Intersection Summary							
HCM 2010 Ctrl Delay			27.5				
HCM 2010 LOS			C				
Notes							

Paseo del Norte

























Direction	EB	WB	All
Average Speed (mph)	24	20	22
Total Travel Time (hr)	232	315	546
Distance Traveled (mi)	5668	6154	11821
Performance Index	127.6	205.2	332.8

Unser Blvd

Direction	EB	NB	SW	All
Average Speed (mph)	28	22	23	23
Total Travel Time (hr)	9	57	76	143
Distance Traveled (mi)	260	1284	1771	3314
Performance Index	5.0	36.5	46.3	87.9

























HCM 2010 Signalized Intersection Summary
 11: Universe & Paseo del Norte

Scheme C -- Year 2035 PM
 6/1/2013

												
Movement	EBL	EBT	EBR	WBL	WBT	WBR	NBL	NBT	NBR	SBL	SBT	SBR
Lane Configurations												
Volume (veh/h)	150	1832	54	100	2101	250	104	500	50	150	400	150
Number	7	4	14	3	8	18	5	2	12	1	6	16
Initial Q (Qb), veh	0	0	0	0	0	0	0	0	0	0	0	0
Ped-Bike Adj(A_pbT)	1.00		1.00	1.00		1.00	1.00		1.00	1.00		1.00
Parking Bus Adj	1.00	1.00	1.00	1.00	1.00	1.00	1.00	1.00	1.00	1.00	1.00	1.00
Adj Sat Flow veh/h/ln	186.3	186.3	186.3	186.3	186.3	186.3	186.3	186.3	186.3	186.3	186.3	186.3
Lanes	2	3	1	2	3	1	2	2	1	2	2	1
Cap, veh/h	212	2847	807	157	2730	774	160	736	313	212	792	337
Arrive On Green	0.06	0.51	0.51	0.05	0.49	0.49	0.09	0.39	0.39	0.06	0.21	0.21
Sat Flow, veh/h	3442	5588	1583	3442	5588	1583	3442	3725	1583	3442	3725	1583
Grp Volume(v), veh/h	150	1832	54	100	2101	250	104	500	50	150	400	150
Grp Sat Flow(s),veh/h/ln	1721	1863	1583	1721	1863	1583	1721	1863	1583	1721	1863	1583
Q Serve(g_s), s	4.4	24.5	1.8	2.9	31.5	6.8	3.0	11.4	2.1	4.4	9.7	6.7
Cycle Q Clear(g_c), s	4.4	24.5	1.8	2.9	31.5	6.8	3.0	11.4	2.1	4.4	9.7	6.7
Prop In Lane	1.00		1.00	1.00		1.00	1.00		1.00	1.00		1.00
Lane Grp Cap(c), veh/h	212	2847	807	157	2730	774	160	736	313	212	792	337
V/C Ratio(X)	0.71	0.64	0.07	0.64	0.77	0.32	0.65	0.68	0.16	0.71	0.51	0.45
Avail Cap(c_a), veh/h	235	2847	807	235	2730	774	235	1347	572	235	1347	572
HCM Platoon Ratio	1.00	1.00	1.00	1.00	1.00	1.00	2.00	2.00	2.00	1.00	1.00	1.00
Upstream Filter(I)	1.00	1.00	1.00	0.61	0.61	0.61	1.00	1.00	1.00	1.00	1.00	1.00
Uniform Delay (d), s/veh	47.1	18.3	12.7	48.0	21.4	7.7	45.6	28.3	25.5	47.1	35.5	22.3
Incr Delay (d2), s/veh	8.3	0.5	0.0	2.6	1.3	0.7	4.4	1.1	0.2	8.3	0.5	0.9
Initial Q Delay(d3),s/veh	0.0	0.0	0.0	0.0	0.0	0.0	0.0	0.0	0.0	0.0	0.0	0.0
%ile Back of Q (50%), veh/ln	2.2	10.6	0.6	1.3	14.0	2.4	1.3	4.4	0.8	2.2	4.5	2.6
Lane Grp Delay (d), s/veh	55.4	18.8	12.8	50.6	22.8	8.4	49.9	29.4	25.7	55.4	36.0	23.2
Lane Grp LOS	E	B	B	D	C	A	D	C	C	E	D	C
Approach Vol, veh/h		2036			2451			654			700	
Approach Delay, s/veh		21.4			22.4			32.4			37.4	
Approach LOS		C			C			C			D	
Timer												
Assigned Phs	7	4		3	8		5	2		1	6	
Phs Duration (G+Y+Rc), s	11.3	57.1		9.2	55.0		9.3	25.2		10.8	26.8	
Change Period (Y+Rc), s	5.0	5.0		4.5	5.0		4.5	5.0		4.5	5.0	
Max Green Setting (Gmax), s	7.0	50.0		7.0	50.0		7.0	37.0		7.0	37.0	
Max Q Clear Time (g_c+I1), s	6.4	26.5		4.9	33.5		5.0	13.4		6.4	11.7	
Green Ext Time (p_c), s	0.0	14.9		0.0	12.9		0.0	6.9		0.0	7.0	
Intersection Summary												
HCM 2010 Ctrl Delay			25.0									
HCM 2010 LOS			C									
Notes												

























HCM 2010 Signalized Intersection Summary
 12: Unser Blvd & Paseo del Norte

Scheme C -- Year 2035 PM
 6/1/2013

												
Movement	SEL	SET	SER	NWL	NWT	NWR	NEL	NET	NER	SWL	SWT	SWR
Lane Configurations												
Volume (veh/h)	100	1900	109	150	2411	100	150	905	200	150	792	150
Number	7	4	14	3	8	18	5	2	12	1	6	16
Initial Q (Qb), veh	0	0	0	0	0	0	0	0	0	0	0	0
Ped-Bike Adj(A_pbT)	1.00		0.98	1.00		0.98	0.99		0.97	1.00		0.97
Parking Bus Adj	1.00	1.00	1.00	1.00	1.00	1.00	1.00	1.00	1.00	1.00	1.00	1.00
Adj Sat Flow veh/h/ln	186.3	186.3	186.3	186.3	186.3	186.3	186.3	186.3	186.3	186.3	186.3	186.3
Lanes	2	3	1	2	3	1	2	2	1	2	2	1
Cap, veh/h	155	2222	615	210	2311	715	498	1184	585	386	1183	560
Arrive On Green	0.05	0.40	0.40	0.06	0.41	0.41	0.05	0.32	0.32	0.09	0.64	0.64
Sat Flow, veh/h	3442	5588	1547	3442	5588	1549	3442	3725	1538	3442	3725	1538
Grp Volume(v), veh/h	100	1900	109	150	2411	100	150	905	200	150	792	150
Grp Sat Flow(s),veh/h/ln	1721	1863	1547	1721	1863	1549	1721	1863	1538	1721	1863	1538
Q Serve(g_s), s	3.2	35.1	5.2	4.8	46.8	4.2	3.3	24.8	10.5	3.3	15.3	4.7
Cycle Q Clear(g_c), s	3.2	35.1	5.2	4.8	46.8	4.2	3.3	24.8	10.5	3.3	15.3	4.7
Prop In Lane	1.00		1.00	1.00		1.00	1.00		1.00	1.00		1.00
Lane Grp Cap(c), veh/h	155	2222	615	210	2311	715	498	1184	585	386	1183	560
V/C Ratio(X)	0.65	0.86	0.18	0.72	1.04	0.14	0.30	0.76	0.34	0.39	0.67	0.27
Avail Cap(c_a), veh/h	304	2222	615	304	2311	715	579	1218	599	468	1218	574
HCM Platoon Ratio	1.00	1.00	1.00	1.00	1.00	1.00	1.00	1.00	1.00	2.00	2.00	2.00
Upstream Filter(I)	0.61	0.61	0.61	0.09	0.09	0.09	0.72	0.72	0.72	0.92	0.92	0.92
Uniform Delay (d), s/veh	53.2	31.1	22.1	52.2	33.2	17.6	25.1	34.8	25.1	25.7	16.9	13.1
Incr Delay (d2), s/veh	2.7	2.8	0.4	0.4	21.1	0.0	0.2	2.1	0.2	0.6	1.3	0.2
Initial Q Delay(d3),s/veh	0.0	0.0	0.0	0.0	0.0	0.0	0.0	0.0	0.0	0.0	0.0	0.0
%ile Back of Q (50%), veh/ln	1.5	16.4	2.0	2.1	25.5	1.5	1.4	11.8	3.9	1.3	4.7	1.5
Lane Grp Delay (d), s/veh	55.9	33.9	22.5	52.6	54.3	17.6	25.3	36.9	25.4	26.3	18.1	13.3
Lane Grp LOS	E	C	C	D	F	B	C	D	C	C	B	B
Approach Vol, veh/h		2109			2661			1255			1092	
Approach Delay, s/veh		34.4			52.8			33.7			18.6	
Approach LOS		C			D			C			B	
Timer												
Assigned Phs	7	4		3	8		5	2		1	6	
Phs Duration (G+Y+Rc), s	10.1	50.0		11.9	51.8		10.3	41.0		10.3	41.0	
Change Period (Y+Rc), s	5.0	5.0		5.0	5.0		5.0	5.0		5.0	5.0	
Max Green Setting (Gmax), s	10.0	45.0		10.0	45.0		8.0	37.0		8.0	37.0	
Max Q Clear Time (g_c+I1), s	5.2	37.1		6.8	48.8		5.3	26.8		5.3	17.3	
Green Ext Time (p_c), s	0.1	7.8		0.1	0.0		0.1	7.5		0.1	12.2	
Intersection Summary												
HCM 2010 Ctrl Delay			38.7									
HCM 2010 LOS			D									
Notes												

HCM 2010 Signalized Intersection Summary
 13: Kimmick Rd & Paseo del Norte

Scheme C -- Year 2035 PM
 6/1/2013

												
Movement	EBL	EBT	EBR	WBL	WBT	WBR	NBL	NBT	NBR	SBL	SBT	SBR
Lane Configurations												
Volume (veh/h)	177	1968	100	200	2456	286	141	150	193	150	150	172
Number	7	4	14	3	8	18	5	2	12	1	6	16
Initial Q (Qb), veh	0	0	0	0	0	0	0	0	0	0	0	0
Ped-Bike Adj(A_pbT)	1.00		0.99	1.00		0.99	0.99		0.98	0.99		0.98
Parking Bus Adj	1.00	1.00	1.00	1.00	1.00	1.00	1.00	1.00	1.00	1.00	1.00	1.00
Adj Sat Flow veh/h/ln	186.3	186.3	186.3	186.3	186.3	193.7	186.3	186.3	186.3	186.3	186.3	186.3
Lanes	2	3	1	2	3	1	1	1	1	2	1	1
Cap, veh/h	243	2469	692	266	2506	731	348	440	367	654	412	343
Arrive On Green	0.07	0.44	0.44	0.08	0.45	0.45	0.07	0.24	0.24	0.05	0.22	0.22
Sat Flow, veh/h	3442	5588	1567	3442	5588	1630	1774	1863	1553	3442	1863	1551
Grp Volume(v), veh/h	177	1968	100	200	2456	286	141	150	193	150	150	172
Grp Sat Flow(s),veh/h/ln	1721	1863	1567	1721	1863	1630	1774	1863	1553	1721	1863	1551
Q Serve(g_s), s	5.2	31.5	4.0	5.9	44.9	12.2	6.2	6.9	11.3	3.4	7.1	10.1
Cycle Q Clear(g_c), s	5.2	31.5	4.0	5.9	44.9	12.2	6.2	6.9	11.3	3.4	7.1	10.1
Prop In Lane	1.00		1.00	1.00		1.00	1.00		1.00	1.00		1.00
Lane Grp Cap(c), veh/h	243	2469	692	266	2506	731	348	440	367	654	412	343
V/C Ratio(X)	0.73	0.80	0.14	0.75	0.98	0.39	0.40	0.34	0.53	0.23	0.36	0.50
Avail Cap(c_a), veh/h	331	2475	694	331	2506	731	348	664	553	706	664	553
HCM Platoon Ratio	1.00	1.00	1.00	1.00	1.00	1.00	1.00	1.00	1.00	1.00	1.00	1.00
Upstream Filter(I)	1.00	1.00	1.00	1.00	1.00	1.00	1.00	1.00	1.00	1.00	1.00	1.00
Uniform Delay (d), s/veh	47.3	25.0	17.3	47.0	28.2	19.2	27.8	33.0	34.6	28.8	34.3	35.4
Incr Delay (d2), s/veh	5.2	2.8	0.4	7.3	13.9	1.6	0.8	0.5	1.2	0.2	0.5	1.1
Initial Q Delay(d3),s/veh	0.0	0.0	0.0	0.0	0.0	0.0	0.0	0.0	0.0	0.0	0.0	0.0
%ile Back of Q (50%), veh/ln	2.4	14.3	0.1	2.8	23.0	5.0	2.8	3.3	4.4	1.5	3.4	3.9
Lane Grp Delay (d), s/veh	52.5	27.8	17.7	54.3	42.1	20.7	28.5	33.4	35.8	29.0	34.8	36.6
Lane Grp LOS	D	C	B	D	D	C	C	C	D	C	C	D
Approach Vol, veh/h		2245			2942			484			472	
Approach Delay, s/veh		29.3			40.8			32.9			33.6	
Approach LOS		C			D			C			C	
Timer												
Assigned Phs	7	4		3	8		5	2		1	6	
Phs Duration (G+Y+Rc), s	12.3	50.9		13.0	51.6		12.0	29.5		10.4	28.0	
Change Period (Y+Rc), s	5.0	5.0		5.0	5.0		5.0	5.0		5.0	5.0	
Max Green Setting (Gmax), s	10.0	46.0		10.0	46.0		7.0	37.0		7.0	37.0	
Max Q Clear Time (g_c+I1), s	7.2	33.5		7.9	46.9		8.2	13.3		5.4	12.1	
Green Ext Time (p_c), s	0.1	12.4		0.1	0.0		0.0	3.1		0.1	3.1	
Intersection Summary												
HCM 2010 Ctrl Delay			35.4									
HCM 2010 LOS			D									
Notes												

























HCM 2010 Signalized Intersection Summary
 14: Transit Blvd & Unser Blvd

Scheme C -- Year 2035 PM
 6/1/2013

	→	↘	↙	←	↖	↗
Movement	EBT	EBR	WBL	WBT	NBL	NBR
Lane Configurations	↑↑	↑	↘↙	↑↑	↖	↗
Volume (veh/h)	899	125	182	810	175	459
Number	4	14	3	8	5	12
Initial Q (Qb), veh	0	0	0	0	0	0
Ped-Bike Adj(A_pbT)		0.98	1.00		1.00	1.00
Parking Bus Adj	1.00	1.00	1.00	1.00	1.00	1.00
Adj Sat Flow veh/h/ln	186.3	186.3	186.3	186.3	186.3	186.3
Lanes	2	1	2	2	1	1
Cap, veh/h	1693	708	252	2134	596	532
Arrive On Green	0.45	0.45	0.07	0.57	0.34	0.34
Sat Flow, veh/h	3725	1557	3442	3725	1774	1583
Grp Volume(v), veh/h	899	125	182	810	175	459
Grp Sat Flow(s),veh/h/ln	1863	1557	1721	1863	1774	1583
Q Serve(g_s), s	19.1	5.2	5.7	13.1	8.0	29.8
Cycle Q Clear(g_c), s	19.1	5.2	5.7	13.1	8.0	29.8
Prop In Lane		1.00	1.00		1.00	1.00
Lane Grp Cap(c), veh/h	1693	708	252	2134	596	532
V/C Ratio(X)	0.53	0.18	0.72	0.38	0.29	0.86
Avail Cap(c_a), veh/h	1693	708	563	2134	596	532
HCM Platoon Ratio	1.00	1.00	1.00	1.00	1.00	1.00
Upstream Filter(I)	1.00	1.00	1.00	1.00	1.00	1.00
Uniform Delay (d), s/veh	21.6	17.8	49.9	12.8	26.9	34.1
Incr Delay (d2), s/veh	1.2	0.5	3.9	0.1	1.2	16.7
Initial Q Delay(d3),s/veh	0.0	0.0	0.0	0.0	0.0	0.0
%ile Back of Q (50%), veh/ln	8.8	2.1	2.6	5.4	3.8	13.9
Lane Grp Delay (d), s/veh	22.8	18.4	53.8	12.9	28.1	50.8
Lane Grp LOS	C	B	D	B	C	D
Approach Vol, veh/h	1024			992	634	
Approach Delay, s/veh	22.2			20.4	44.6	
Approach LOS	C			C	D	
Timer						
Assigned Phs	4		3	8		
Phs Duration (G+Y+Rc), s	55.0		13.0	68.0		
Change Period (Y+Rc), s	5.0		5.0	5.0		
Max Green Setting (Gmax), s	50.0		18.0	50.0		
Max Q Clear Time (g_c+I1), s	21.1		7.7	15.1		
Green Ext Time (p_c), s	14.2		0.4	15.5		
Intersection Summary						
HCM 2010 Ctrl Delay			26.9			
HCM 2010 LOS			C			
Notes						

























HCM 2010 Signalized Intersection Summary
 101: Paseo del Norte & Loop Rd W/Loop Rd N





























Scheme C -- Year 2035 PM
 6/1/2013

												
Movement	EBL	EBT	EBR	WBL	WBT	WBR	SEL	SET	SER	NWL	NWT	NWR
Lane Configurations												
Volume (veh/h)	114	100	246	133	100	137	131	1730	172	262	2200	250
Number	5	2	12	1	6	16	7	4	14	3	8	18
Initial Q (Qb), veh	0	0	0	0	0	0	0	0	0	0	0	0
Ped-Bike Adj(A_pbT)	1.00		1.00	1.00		1.00	1.00		1.00	1.00		1.00
Parking Bus Adj	1.00	1.00	1.00	1.00	1.00	1.00	1.00	1.00	1.00	1.00	1.00	1.00
Adj Sat Flow veh/h/ln	186.3	186.3	186.3	186.3	186.3	186.3	186.3	186.3	193.7	186.3	186.3	193.7
Lanes	1	1	1	1	1	1	1	3	1	1	3	1
Cap, veh/h	262	401	341	244	401	341	159	3012	888	185	3091	911
Arrive On Green	0.22	0.22	0.22	0.22	0.22	0.22	0.09	0.54	0.54	0.21	1.00	1.00
Sat Flow, veh/h	1139	1863	1583	1031	1863	1583	1774	5588	1647	1774	5588	1647
Grp Volume(v), veh/h	114	100	246	133	100	137	131	1730	172	262	2200	250
Grp Sat Flow(s),veh/h/ln	1139	1863	1583	1031	1863	1583	1774	1863	1647	1774	1863	1647
Q Serve(g_s), s	9.8	4.7	15.3	13.0	4.7	7.9	7.7	21.9	5.7	11.0	0.0	0.0
Cycle Q Clear(g_c), s	14.5	4.7	15.3	17.7	4.7	7.9	7.7	21.9	5.7	11.0	0.0	0.0
Prop In Lane	1.00		1.00	1.00		1.00	1.00		1.00	1.00		1.00
Lane Grp Cap(c), veh/h	262	401	341	244	401	341	159	3012	888	185	3091	911
V/C Ratio(X)	0.43	0.25	0.72	0.55	0.25	0.40	0.82	0.57	0.19	1.42	0.71	0.27
Avail Cap(c_a), veh/h	416	652	554	383	652	554	185	3012	888	185	3091	911
HCM Platoon Ratio	1.00	1.00	1.00	1.00	1.00	1.00	1.00	1.00	1.00	2.00	2.00	2.00
Upstream Filter(I)	1.00	1.00	1.00	1.00	1.00	1.00	0.63	0.63	0.63	0.09	0.09	0.09
Uniform Delay (d), s/veh	40.4	34.4	38.6	41.8	34.4	35.7	47.3	16.3	12.5	41.9	0.0	0.0
Incr Delay (d2), s/veh	1.1	0.3	2.9	1.9	0.3	0.8	15.0	0.5	0.3	191.8	0.1	0.1
Initial Q Delay(d3),s/veh	0.0	0.0	0.0	0.0	0.0	0.0	0.0	0.0	0.0	0.0	0.0	0.0
%ile Back of Q (50%), veh/ln	2.9	2.3	6.2	3.6	2.3	3.2	4.1	9.3	2.2	14.1	0.0	0.0
Lane Grp Delay (d), s/veh	41.6	34.7	41.5	43.7	34.7	36.4	62.3	16.8	12.9	233.7	0.1	0.1
Lane Grp LOS	D	C	D	D	C	D	E	B	B	F	A	A
Approach Vol, veh/h		460			370			2033			2712	
Approach Delay, s/veh		40.0			38.6			19.4			22.7	
Approach LOS		D			D			B			C	
Timer												
Assigned Phs		2			6		7	4		3		8
Phs Duration (G+Y+Rc), s		27.8			27.8		14.5	62.0		16.0		63.5
Change Period (Y+Rc), s		5.0			5.0		5.0	5.0		5.0		5.0
Max Green Setting (Gmax), s		37.0			37.0		11.0	57.0		11.0		57.0
Max Q Clear Time (g_c+I1), s		17.3			19.7		9.7	23.9		13.0		2.0
Green Ext Time (p_c), s		3.1			3.0		0.0	31.7		0.0		51.2
Intersection Summary												
HCM 2010 Ctrl Delay			24.0									
HCM 2010 LOS			C									
Notes												

HCM 2010 Signalized Intersection Summary
 102: Unser Blvd & Loop Rd N

























Scheme C -- Year 2035 PM
 6/1/2013

												
Movement	SEL	SET	SER	NWL	NWT	NWR	NEL	NET	NER	SWL	SWT	SWR
Lane Configurations												
Volume (veh/h)	100	100	150	150	100	150	131	775	200	100	791	63
Number	1	6	16	5	2	12	7	4	14	3	8	18
Initial Q (Qb), veh	0	0	0	0	0	0	0	0	0	0	0	0
Ped-Bike Adj(A_pbT)	1.00		1.00	1.00		1.00	1.00		1.00	1.00		1.00
Parking Bus Adj	1.00	1.00	1.00	1.00	1.00	1.00	1.00	1.00	1.00	1.00	1.00	1.00
Adj Sat Flow veh/h/ln	186.3	186.3	186.3	186.3	186.3	186.3	186.3	186.3	186.3	186.3	186.3	186.3
Lanes	1	1	1	1	1	1	1	2	1	1	2	1
Cap, veh/h	261	403	343	261	403	343	458	2568	1091	417	2568	1091
Arrive On Green	0.22	0.22	0.22	0.22	0.22	0.22	0.69	0.69	0.69	0.69	0.69	0.69
Sat Flow, veh/h	1125	1863	1583	1125	1863	1583	644	3725	1583	574	3725	1583
Grp Volume(v), veh/h	100	100	150	150	100	150	131	775	200	100	791	63
Grp Sat Flow(s),veh/h/ln	1125	1863	1583	1125	1863	1583	644	1863	1583	574	1863	1583
Q Serve(g_s), s	8.6	4.7	8.7	13.5	4.7	8.7	10.7	8.6	4.8	8.8	8.9	1.4
Cycle Q Clear(g_c), s	13.3	4.7	8.7	18.2	4.7	8.7	19.6	8.6	4.8	17.4	8.9	1.4
Prop In Lane	1.00		1.00	1.00		1.00	1.00		1.00	1.00		1.00
Lane Grp Cap(c), veh/h	261	403	343	261	403	343	458	2568	1091	417	2568	1091
V/C Ratio(X)	0.38	0.25	0.44	0.57	0.25	0.44	0.29	0.30	0.18	0.24	0.31	0.06
Avail Cap(c_a), veh/h	411	651	553	411	651	553	458	2568	1091	417	2568	1091
HCM Platoon Ratio	1.00	1.00	1.00	1.00	1.00	1.00	1.00	1.00	1.00	1.00	1.00	1.00
Upstream Filter(I)	1.00	1.00	1.00	0.99	0.99	0.99	0.53	0.53	0.53	1.00	1.00	1.00
Uniform Delay (d), s/veh	39.9	34.4	35.9	41.9	34.4	35.9	10.4	6.5	5.9	9.9	6.5	5.3
Incr Delay (d2), s/veh	0.9	0.3	0.9	2.0	0.3	0.9	0.8	0.2	0.2	1.4	0.3	0.1
Initial Q Delay(d3),s/veh	0.0	0.0	0.0	0.0	0.0	0.0	0.0	0.0	0.0	0.0	0.0	0.0
%ile Back of Q (50%), veh/ln	2.5	2.3	3.5	4.0	2.3	3.5	1.6	3.3	1.6	1.2	3.4	0.5
Lane Grp Delay (d), s/veh	40.8	34.7	36.8	43.9	34.7	36.8	11.2	6.6	6.1	11.2	6.8	5.4
Lane Grp LOS	D	C	D	D	C	D	B	A	A	B	A	A
Approach Vol, veh/h		350			400			1106			954	
Approach Delay, s/veh		37.3			38.9			7.1			7.2	
Approach LOS		D			D			A			A	
Timer												
Assigned Phs		6			2			4			8	
Phs Duration (G+Y+Rc), s		27.9			27.9			78.0			78.0	
Change Period (Y+Rc), s		5.0			5.0			5.0			5.0	
Max Green Setting (Gmax), s		37.0			37.0			73.0			73.0	
Max Q Clear Time (g_c+I1), s		15.3			20.2			21.6			19.4	
Green Ext Time (p_c), s		2.9			2.7			18.4			18.6	
Intersection Summary												
HCM 2010 Ctrl Delay			15.4									
HCM 2010 LOS			B									
Notes												

												
Movement	SEL	SET	SER	NWL	NWT	NWR	NEL	NET	NER	SWL	SWT	SWR
Lane Configurations		  			  							
Volume (veh/h)	200	1800	250	262	2233	343	135	100	272	178	100	293
Number	7	4	14	3	8	18	5	2	12	1	6	16
Initial Q (Qb), veh	0	0	0	0	0	0	0	0	0	0	0	0
Ped-Bike Adj(A_pbT)	1.00		1.00	1.00		1.00	1.00		1.00	1.00		1.00
Parking Bus Adj	1.00	1.00	1.00	1.00	1.00	1.00	1.00	1.00	1.00	1.00	1.00	1.00
Adj Sat Flow veh/h/ln	167.6	167.6	174.4	167.6	167.6	174.4	167.6	167.6	167.6	167.6	167.6	167.6
Lanes	1	3	1	1	3	1	1	1	1	1	1	1
Cap, veh/h	181	2412	711	181	2412	711	267	463	394	271	463	394
Arrive On Green	0.11	0.48	0.48	0.11	0.48	0.48	0.28	0.28	0.28	0.28	0.28	0.28
Sat Flow, veh/h	1597	5029	1482	1597	5029	1482	888	1676	1425	906	1676	1425
Grp Volume(v), veh/h	200	1800	250	262	2233	343	135	100	272	178	100	293
Grp Sat Flow(s),veh/h/ln	1597	1676	1482	1597	1676	1482	888	1676	1425	906	1676	1425
Q Serve(g_s), s	13.0	33.3	12.1	13.0	47.7	18.0	15.8	5.3	19.6	21.6	5.3	21.5
Cycle Q Clear(g_c), s	13.0	33.3	12.1	13.0	47.7	18.0	21.1	5.3	19.6	26.9	5.3	21.5
Prop In Lane	1.00		1.00	1.00		1.00	1.00		1.00	1.00		1.00
Lane Grp Cap(c), veh/h	181	2412	711	181	2412	711	267	463	394	271	463	394
V/C Ratio(X)	1.11	0.75	0.35	1.45	0.93	0.48	0.50	0.22	0.69	0.66	0.22	0.74
Avail Cap(c_a), veh/h	181	2412	711	181	2412	711	309	541	460	313	541	460
HCM Platoon Ratio	1.00	1.00	1.00	1.00	1.00	1.00	1.00	1.00	1.00	1.00	1.00	1.00
Upstream Filter(I)	0.33	0.33	0.33	1.00	1.00	1.00	1.00	1.00	1.00	1.00	1.00	1.00
Uniform Delay (d), s/veh	50.8	24.2	18.7	50.8	27.9	20.2	40.0	31.9	37.1	42.3	31.9	37.8
Incr Delay (d2), s/veh	70.7	0.7	0.5	229.7	7.6	2.3	1.5	0.2	3.6	4.0	0.2	5.5
Initial Q Delay(d3),s/veh	0.0	0.0	0.0	0.0	0.0	0.0	0.0	0.0	0.0	0.0	0.0	0.0
%ile Back of Q (50%), veh/ln	8.8	13.3	4.3	16.8	20.5	6.8	3.7	2.3	7.3	5.3	2.3	8.2
Lane Grp Delay (d), s/veh	121.6	24.9	19.1	280.5	35.5	22.6	41.5	32.2	40.7	46.2	32.2	43.3
Lane Grp LOS	F	C	B	F	D	C	D	C	D	D	C	D
Approach Vol, veh/h		2250			2838			507			571	
Approach Delay, s/veh		32.9			56.6			39.2			42.3	
Approach LOS		C			E			D			D	
Timer												
Assigned Phs	7	4		3	8			2			6	
Phs Duration (G+Y+Rc), s	18.0	60.0		18.0	60.0			36.7			36.7	
Change Period (Y+Rc), s	5.0	5.0		5.0	5.0			5.0			5.0	
Max Green Setting (Gmax), s	13.0	55.0		13.0	55.0			37.0			37.0	
Max Q Clear Time (g_c+I1), s	15.0	35.3		15.0	49.7			23.1			28.9	
Green Ext Time (p_c), s	0.0	19.3		0.0	5.3			3.7			2.8	
Intersection Summary												
HCM 2010 Ctrl Delay			45.2									
HCM 2010 LOS			D									
Notes												

HCM 2010 Signalized Intersection Summary
 104: Unser Blvd & Loop Rd W/Avenida de Jaimito

Scheme C -- Year 2035 PM
 6/1/2013

												
Movement	EBL	EBT	EBR	WBL	WBT	WBR	NBL	NBT	NBR	SBL	SBT	SBR
Lane Configurations												
Volume (veh/h)	50	100	180	180	100	100	121	1105	202	50	800	200
Number	7	4	14	3	8	18	5	2	12	1	6	16
Initial Q (Qb), veh	0	0	0	0	0	0	0	0	0	0	0	0
Ped-Bike Adj(A_pbT)	1.00		1.00	1.00		1.00	1.00		1.00	1.00		1.00
Parking Bus Adj	1.00	1.00	1.00	1.00	1.00	1.00	1.00	1.00	1.00	1.00	1.00	1.00
Adj Sat Flow veh/h/ln	186.3	186.3	186.3	186.3	186.3	186.3	186.3	186.3	186.3	186.3	186.3	186.3
Lanes	1	1	1	1	1	1	1	2	1	1	2	1
Cap, veh/h	435	639	544	410	639	544	316	2059	875	228	2059	875
Arrive On Green	0.34	0.34	0.34	0.34	0.34	0.34	0.55	0.55	0.55	0.55	0.55	0.55
Sat Flow, veh/h	1178	1863	1583	1095	1863	1583	561	3725	1583	419	3725	1583
Grp Volume(v), veh/h	50	100	180	180	100	100	121	1105	202	50	800	200
Grp Sat Flow(s),veh/h/ln	1178	1863	1583	1095	1863	1583	561	1863	1583	419	1863	1583
Q Serve(g_s), s	3.0	3.6	8.1	13.1	3.6	4.3	15.1	18.1	6.3	8.3	11.8	6.2
Cycle Q Clear(g_c), s	6.5	3.6	8.1	16.7	3.6	4.3	26.8	18.1	6.3	26.4	11.8	6.2
Prop In Lane	1.00		1.00	1.00		1.00	1.00		1.00	1.00		1.00
Lane Grp Cap(c), veh/h	435	639	544	410	639	544	316	2059	875	228	2059	875
V/C Ratio(X)	0.11	0.16	0.33	0.44	0.16	0.18	0.38	0.54	0.23	0.22	0.39	0.23
Avail Cap(c_a), veh/h	435	639	544	410	639	544	456	2984	1268	332	2984	1268
HCM Platoon Ratio	1.00	1.00	1.00	1.00	1.00	1.00	1.00	1.00	1.00	1.00	1.00	1.00
Upstream Filter(I)	1.00	1.00	1.00	1.00	1.00	1.00	0.46	0.46	0.46	0.66	0.66	0.66
Uniform Delay (d), s/veh	24.2	21.9	23.4	27.7	21.9	22.1	19.9	13.7	11.0	22.1	12.2	11.0
Incr Delay (d2), s/veh	0.5	0.5	1.6	3.4	0.5	0.7	0.4	0.1	0.1	0.3	0.1	0.1
Initial Q Delay(d3),s/veh	0.0	0.0	0.0	0.0	0.0	0.0	0.0	0.0	0.0	0.0	0.0	0.0
%ile Back of Q (50%), veh/ln	0.9	1.8	3.4	3.9	1.8	1.8	2.0	7.4	2.1	0.9	4.8	2.1
Lane Grp Delay (d), s/veh	24.7	22.4	25.0	31.1	22.4	22.9	20.2	13.8	11.1	22.4	12.3	11.1
Lane Grp LOS	C	C	C	C	C	C	C	B	B	C	B	B
Approach Vol, veh/h		330			380			1428			1050	
Approach Delay, s/veh		24.2			26.6			13.9			12.6	
Approach LOS		C			C			B			B	
Timer												
Assigned Phs		4			8			2			6	
Phs Duration (G+Y+Rc), s		38.0			38.0			58.1			58.1	
Change Period (Y+Rc), s		5.0			5.0			5.0			5.0	
Max Green Setting (Gmax), s		33.0			33.0			77.0			77.0	
Max Q Clear Time (g_c+I1), s		10.1			18.7			28.8			28.4	
Green Ext Time (p_c), s		2.8			2.5			24.3			24.4	
Intersection Summary												
HCM 2010 Ctrl Delay				16.1								
HCM 2010 LOS				B								
Notes												

Paseo del Norte

























Direction	EB	WB	All
Average Speed (mph)	24	20	22
Total Travel Time (hr)	235	305	539
Distance Traveled (mi)	5631	6070	11701
Performance Index	130.2	198.6	328.8

Unser Blvd

Direction	EB	NB	SW	All
Average Speed (mph)	24	23	21	22
Total Travel Time (hr)	11	58	65	134
Distance Traveled (mi)	267	1301	1392	2960
Performance Index	6.7	37.2	43.1	87.0

























HCM 2010 Signalized Intersection Summary
 11: Universe & Paseo del Norte

Scheme D -- Year 2035 PM
 6/6/2013

												
Movement	EBL	EBT	EBR	WBL	WBT	WBR	NBL	NBT	NBR	SBL	SBT	SBR
Lane Configurations												
Volume (veh/h)	150	1832	54	100	2101	250	104	500	50	150	400	150
Number	7	4	14	3	8	18	5	2	12	1	6	16
Initial Q (Qb), veh	0	0	0	0	0	0	0	0	0	0	0	0
Ped-Bike Adj(A_pbT)	1.00		1.00	1.00		1.00	1.00		1.00	1.00		1.00
Parking Bus Adj	1.00	1.00	1.00	1.00	1.00	1.00	1.00	1.00	1.00	1.00	1.00	1.00
Adj Sat Flow veh/h/ln	186.3	186.3	186.3	186.3	186.3	186.3	186.3	186.3	186.3	186.3	186.3	186.3
Lanes	2	3	1	2	3	1	2	2	1	2	2	1
Cap, veh/h	212	2847	807	157	2730	774	160	736	313	212	792	337
Arrive On Green	0.06	0.51	0.51	0.05	0.49	0.49	0.09	0.39	0.39	0.06	0.21	0.21
Sat Flow, veh/h	3442	5588	1583	3442	5588	1583	3442	3725	1583	3442	3725	1583
Grp Volume(v), veh/h	150	1832	54	100	2101	250	104	500	50	150	400	150
Grp Sat Flow(s),veh/h/ln	1721	1863	1583	1721	1863	1583	1721	1863	1583	1721	1863	1583
Q Serve(g_s), s	4.4	24.5	1.8	2.9	31.5	6.8	3.0	11.4	2.1	4.4	9.7	6.7
Cycle Q Clear(g_c), s	4.4	24.5	1.8	2.9	31.5	6.8	3.0	11.4	2.1	4.4	9.7	6.7
Prop In Lane	1.00		1.00	1.00		1.00	1.00		1.00	1.00		1.00
Lane Grp Cap(c), veh/h	212	2847	807	157	2730	774	160	736	313	212	792	337
V/C Ratio(X)	0.71	0.64	0.07	0.64	0.77	0.32	0.65	0.68	0.16	0.71	0.51	0.45
Avail Cap(c_a), veh/h	235	2847	807	235	2730	774	235	1347	572	235	1347	572
HCM Platoon Ratio	1.00	1.00	1.00	1.00	1.00	1.00	2.00	2.00	2.00	1.00	1.00	1.00
Upstream Filter(I)	1.00	1.00	1.00	0.65	0.65	0.65	1.00	1.00	1.00	1.00	1.00	1.00
Uniform Delay (d), s/veh	47.1	18.3	12.7	48.0	21.4	7.7	45.6	28.3	25.5	47.1	35.5	22.3
Incr Delay (d2), s/veh	8.3	0.5	0.0	2.8	1.4	0.7	4.4	1.1	0.2	8.3	0.5	0.9
Initial Q Delay(d3),s/veh	0.0	0.0	0.0	0.0	0.0	0.0	0.0	0.0	0.0	0.0	0.0	0.0
%ile Back of Q (50%), veh/ln	2.2	10.6	0.6	1.3	14.0	2.4	1.3	4.4	0.8	2.2	4.5	2.6
Lane Grp Delay (d), s/veh	55.4	18.8	12.8	50.8	22.9	8.5	49.9	29.4	25.7	55.4	36.0	23.2
Lane Grp LOS	E	B	B	D	C	A	D	C	C	E	D	C
Approach Vol, veh/h		2036			2451			654			700	
Approach Delay, s/veh		21.4			22.5			32.4			37.4	
Approach LOS		C			C			C			D	
Timer												
Assigned Phs	7	4		3	8		5	2		1	6	
Phs Duration (G+Y+Rc), s	11.3	57.1		9.2	55.0		9.3	25.2		10.8	26.8	
Change Period (Y+Rc), s	5.0	5.0		4.5	5.0		4.5	5.0		4.5	5.0	
Max Green Setting (Gmax), s	7.0	50.0		7.0	50.0		7.0	37.0		7.0	37.0	
Max Q Clear Time (g_c+I1), s	6.4	26.5		4.9	33.5		5.0	13.4		6.4	11.7	
Green Ext Time (p_c), s	0.0	14.9		0.0	12.9		0.0	6.9		0.0	7.0	
Intersection Summary												
HCM 2010 Ctrl Delay			25.0									
HCM 2010 LOS			C									
Notes												

























HCM 2010 Signalized Intersection Summary
 12: Unser Blvd & Paseo del Norte

Scheme D -- Year 2035 PM
 6/6/2013

												
Movement	SEL	SET	SER	NWL	NWT	NWR	NEL	NET	NER	SWL	SWT	SWR
Lane Configurations												
Volume (veh/h)	100	1900	109	150	2411	100	150	905	200	150	792	150
Number	7	4	14	3	8	18	5	2	12	1	6	16
Initial Q (Qb), veh	0	0	0	0	0	0	0	0	0	0	0	0
Ped-Bike Adj(A_pbT)	1.00		0.98	1.00		0.98	0.99		0.97	1.00		0.97
Parking Bus Adj	1.00	1.00	1.00	1.00	1.00	1.00	1.00	1.00	1.00	1.00	1.00	1.00
Adj Sat Flow veh/h/ln	186.3	186.3	186.3	186.3	186.3	186.3	186.3	186.3	186.3	186.3	186.3	186.3
Lanes	2	3	1	2	3	1	2	2	1	2	2	1
Cap, veh/h	155	2222	615	210	2311	715	498	1184	585	386	1183	560
Arrive On Green	0.05	0.40	0.40	0.06	0.41	0.41	0.05	0.32	0.32	0.09	0.64	0.64
Sat Flow, veh/h	3442	5588	1547	3442	5588	1549	3442	3725	1538	3442	3725	1538
Grp Volume(v), veh/h	100	1900	109	150	2411	100	150	905	200	150	792	150
Grp Sat Flow(s),veh/h/ln	1721	1863	1547	1721	1863	1549	1721	1863	1538	1721	1863	1538
Q Serve(g_s), s	3.2	35.1	5.2	4.8	46.8	4.2	3.3	24.8	10.5	3.3	15.3	4.7
Cycle Q Clear(g_c), s	3.2	35.1	5.2	4.8	46.8	4.2	3.3	24.8	10.5	3.3	15.3	4.7
Prop In Lane	1.00		1.00	1.00		1.00	1.00		1.00	1.00		1.00
Lane Grp Cap(c), veh/h	155	2222	615	210	2311	715	498	1184	585	386	1183	560
V/C Ratio(X)	0.65	0.86	0.18	0.72	1.04	0.14	0.30	0.76	0.34	0.39	0.67	0.27
Avail Cap(c_a), veh/h	304	2222	615	304	2311	715	579	1218	599	468	1218	574
HCM Platoon Ratio	1.00	1.00	1.00	1.00	1.00	1.00	1.00	1.00	1.00	2.00	2.00	2.00
Upstream Filter(I)	0.62	0.62	0.62	0.44	0.44	0.44	0.72	0.72	0.72	0.92	0.92	0.92
Uniform Delay (d), s/veh	53.2	31.1	22.1	52.2	33.2	17.6	25.1	34.8	25.1	25.7	16.9	13.1
Incr Delay (d2), s/veh	2.8	2.9	0.4	2.0	25.7	0.2	0.2	2.1	0.2	0.6	1.3	0.2
Initial Q Delay(d3),s/veh	0.0	0.0	0.0	0.0	0.0	0.0	0.0	0.0	0.0	0.0	0.0	0.0
%ile Back of Q (50%), veh/ln	1.5	16.4	2.0	2.2	26.5	1.5	1.4	11.8	3.9	1.3	4.7	1.5
Lane Grp Delay (d), s/veh	55.9	34.0	22.5	54.2	58.9	17.8	25.3	36.9	25.4	26.3	18.1	13.3
Lane Grp LOS	E	C	C	D	F	B	C	D	C	C	B	B
Approach Vol, veh/h		2109			2661			1255			1092	
Approach Delay, s/veh		34.4			57.1			33.7			18.6	
Approach LOS		C			E			C			B	
Timer												
Assigned Phs	7	4		3	8		5	2		1	6	
Phs Duration (G+Y+Rc), s	10.1	50.0		11.9	51.8		10.3	41.0		10.3	41.0	
Change Period (Y+Rc), s	5.0	5.0		5.0	5.0		5.0	5.0		5.0	5.0	
Max Green Setting (Gmax), s	10.0	45.0		10.0	45.0		8.0	37.0		8.0	37.0	
Max Q Clear Time (g_c+I1), s	5.2	37.1		6.8	48.8		5.3	26.8		5.3	17.3	
Green Ext Time (p_c), s	0.1	7.8		0.1	0.0		0.1	7.5		0.1	12.2	
Intersection Summary												
HCM 2010 Ctrl Delay			40.3									
HCM 2010 LOS			D									
Notes												







HCM 2010 Signalized Intersection Summary
 13: Kimmick Rd & Paseo del Norte

Scheme D -- Year 2035 PM
 6/6/2013

												
Movement	EBL	EBT	EBR	WBL	WBT	WBR	NBL	NBT	NBR	SBL	SBT	SBR
Lane Configurations												
Volume (veh/h)	132	2018	100	200	2456	243	141	150	193	100	150	172
Number	7	4	14	3	8	18	5	2	12	1	6	16
Initial Q (Qb), veh	0	0	0	0	0	0	0	0	0	0	0	0
Ped-Bike Adj(A_pbT)	1.00		0.99	1.00		0.99	0.99		0.98	0.99		0.98
Parking Bus Adj	1.00	1.00	1.00	1.00	1.00	1.00	1.00	1.00	1.00	1.00	1.00	1.00
Adj Sat Flow veh/h/ln	186.3	186.3	186.3	186.3	186.3	193.7	186.3	186.3	186.3	186.3	186.3	186.3
Lanes	2	3	1	2	3	1	1	1	1	1	1	1
Cap, veh/h	197	2502	702	270	2619	764	326	429	357	323	429	357
Arrive On Green	0.06	0.45	0.45	0.08	0.47	0.47	0.05	0.23	0.23	0.05	0.23	0.23
Sat Flow, veh/h	3442	5588	1567	3442	5588	1631	1774	1863	1552	1774	1863	1552
Grp Volume(v), veh/h	132	2018	100	200	2456	243	141	150	193	100	150	172
Grp Sat Flow(s),veh/h/ln	1721	1863	1567	1721	1863	1631	1774	1863	1552	1774	1863	1552
Q Serve(g_s), s	3.9	32.0	3.9	5.8	42.7	9.5	5.0	6.9	11.2	4.4	6.9	9.8
Cycle Q Clear(g_c), s	3.9	32.0	3.9	5.8	42.7	9.5	5.0	6.9	11.2	4.4	6.9	9.8
Prop In Lane	1.00		1.00	1.00		1.00	1.00		1.00	1.00		1.00
Lane Grp Cap(c), veh/h	197	2502	702	270	2619	764	326	429	357	323	429	357
V/C Ratio(X)	0.67	0.81	0.14	0.74	0.94	0.32	0.43	0.35	0.54	0.31	0.35	0.48
Avail Cap(c_a), veh/h	403	2507	703	403	2619	764	326	672	560	323	672	560
HCM Platoon Ratio	1.00	1.00	1.00	1.00	1.00	1.00	1.00	1.00	1.00	1.00	1.00	1.00
Upstream Filter(I)	0.81	0.81	0.81	1.00	1.00	1.00	1.00	1.00	1.00	1.00	1.00	1.00
Uniform Delay (d), s/veh	47.4	24.5	16.7	46.2	25.8	17.0	30.6	33.0	34.7	28.5	33.0	34.2
Incr Delay (d2), s/veh	3.2	2.4	0.3	4.0	8.0	1.1	0.9	0.5	1.3	0.5	0.5	1.0
Initial Q Delay(d3),s/veh	0.0	0.0	0.0	0.0	0.0	0.0	0.0	0.0	0.0	0.0	0.0	0.0
%ile Back of Q (50%), veh/ln	1.8	14.6	1.5	2.7	20.6	3.7	0.8	3.3	4.4	2.0	3.3	3.8
Lane Grp Delay (d), s/veh	50.5	26.8	17.0	50.2	33.9	18.1	31.5	33.5	36.0	29.0	33.5	35.2
Lane Grp LOS	D	C	B	D	C	B	C	C	D	C	C	D
Approach Vol, veh/h		2250			2899			484			422	
Approach Delay, s/veh		27.8			33.7			33.9			33.1	
Approach LOS		C			C			C			C	
Timer												
Assigned Phs	7	4		3	8		5	2		1	6	
Phs Duration (G+Y+Rc), s	10.9	50.9		13.0	53.0		10.0	28.6		10.0	28.6	
Change Period (Y+Rc), s	5.0	5.0		5.0	5.0		5.0	5.0		5.0	5.0	
Max Green Setting (Gmax), s	12.0	46.0		12.0	46.0		5.0	37.0		5.0	37.0	
Max Q Clear Time (g_c+I1), s	5.9	34.0		7.8	44.7		7.0	13.2		6.4	11.8	
Green Ext Time (p_c), s	0.2	11.9		0.2	1.3		0.0	3.1		0.0	3.1	
Intersection Summary												
HCM 2010 Ctrl Delay			31.5									
HCM 2010 LOS			C									
Notes												

























HCM 2010 Signalized Intersection Summary
 14: Transit Blvd & Unser Blvd

Scheme D -- Year 2035 PM
 6/6/2013

						
Movement	EBT	EBR	WBL	WBT	NBL	NBR
Lane Configurations	↑↑	↑	↑↑	↑↑	↑	↑
Volume (veh/h)	999	100	182	810	175	309
Number	4	14	3	8	5	12
Initial Q (Qb), veh	0	0	0	0	0	0
Ped-Bike Adj(A_pbT)		0.98	1.00		1.00	1.00
Parking Bus Adj	1.00	1.00	1.00	1.00	1.00	1.00
Adj Sat Flow veh/h/ln	186.3	186.3	186.3	186.3	186.3	186.3
Lanes	2	1	2	2	1	1
Cap, veh/h	1693	708	252	2134	596	532
Arrive On Green	0.45	0.45	0.07	0.57	0.34	0.34
Sat Flow, veh/h	3725	1557	3442	3725	1774	1583
Grp Volume(v), veh/h	999	100	182	810	175	309
Grp Sat Flow(s),veh/h/ln	1863	1557	1721	1863	1774	1583
Q Serve(g_s), s	22.0	4.1	5.7	13.1	8.0	17.7
Cycle Q Clear(g_c), s	22.0	4.1	5.7	13.1	8.0	17.7
Prop In Lane		1.00	1.00		1.00	1.00
Lane Grp Cap(c), veh/h	1693	708	252	2134	596	532
V/C Ratio(X)	0.59	0.14	0.72	0.38	0.29	0.58
Avail Cap(c_a), veh/h	1693	708	563	2134	596	532
HCM Platoon Ratio	1.00	1.00	1.00	1.00	1.00	1.00
Upstream Filter(I)	1.00	1.00	1.00	1.00	1.00	1.00
Uniform Delay (d), s/veh	22.4	17.5	49.9	12.8	26.9	30.1
Incr Delay (d2), s/veh	1.5	0.4	3.9	0.1	1.2	4.6
Initial Q Delay(d3),s/veh	0.0	0.0	0.0	0.0	0.0	0.0
%ile Back of Q (50%), veh/ln	10.2	1.6	2.6	5.4	3.8	7.5
Lane Grp Delay (d), s/veh	23.9	17.9	53.8	12.9	28.1	34.7
Lane Grp LOS	C	B	D	B	C	C
Approach Vol, veh/h	1099			992	484	
Approach Delay, s/veh	23.4			20.4	32.3	
Approach LOS	C			C	C	
Timer						
Assigned Phs	4		3	8		
Phs Duration (G+Y+Rc), s	55.0		13.0	68.0		
Change Period (Y+Rc), s	5.0		5.0	5.0		
Max Green Setting (Gmax), s	50.0		18.0	50.0		
Max Q Clear Time (g_c+I1), s	24.0		7.7	15.1		
Green Ext Time (p_c), s	14.2		0.4	16.5		
Intersection Summary						
HCM 2010 Ctrl Delay			23.9			
HCM 2010 LOS			C			
Notes						

























HCM 2010 Signalized Intersection Summary
101: Paseo del Norte & Loop Rd W

Scheme D -- Year 2035 PM
6/6/2013

												
Movement	EBL	EBT	EBR	WBL	WBT	WBR	SEL	SET	SER	NWL	NWT	NWR
Lane Configurations												
Volume (veh/h)	114	100	246	133	100	137	131	1730	172	261	2200	250
Number	5	2	12	1	6	16	7	4	14	3	8	18
Initial Q (Qb), veh	0	0	0	0	0	0	0	0	0	0	0	0
Ped-Bike Adj(A_pbT)	0.98		0.98	0.99		0.98	1.00		0.98	1.00		0.99
Parking Bus Adj	1.00	1.00	1.00	1.00	1.00	1.00	1.00	1.00	1.00	1.00	1.00	1.00
Adj Sat Flow veh/h/ln	186.3	186.3	186.3	186.3	186.3	186.3	186.3	186.3	193.7	186.3	186.3	193.7
Lanes	1	1	1	1	1	1	1	3	1	1	3	1
Cap, veh/h	312	490	407	289	490	407	169	2823	815	174	2837	826
Arrive On Green	0.26	0.26	0.26	0.26	0.26	0.26	0.10	0.51	0.51	0.20	1.00	1.00
Sat Flow, veh/h	1121	1863	1547	1017	1863	1547	1774	5588	1614	1774	5588	1627
Grp Volume(v), veh/h	114	100	246	133	100	137	131	1730	172	261	2200	250
Grp Sat Flow(s),veh/h/ln	1121	1863	1547	1017	1863	1547	1774	1863	1614	1774	1863	1627
Q Serve(g_s), s	9.9	4.7	15.6	13.1	4.7	8.0	8.1	24.9	6.6	11.0	0.0	0.0
Cycle Q Clear(g_c), s	14.6	4.7	15.6	17.8	4.7	8.0	8.1	24.9	6.6	11.0	0.0	0.0
Prop In Lane	1.00		1.00	1.00		1.00	1.00		1.00	1.00		1.00
Lane Grp Cap(c), veh/h	312	490	407	289	490	407	169	2823	815	174	2837	826
V/C Ratio(X)	0.36	0.20	0.60	0.46	0.20	0.34	0.77	0.61	0.21	1.50	0.78	0.30
Avail Cap(c_a), veh/h	387	614	510	357	614	510	174	2837	819	174	2837	826
HCM Platoon Ratio	1.00	1.00	1.00	1.00	1.00	1.00	1.00	1.00	1.00	2.00	2.00	2.00
Upstream Filter(I)	1.00	1.00	1.00	1.00	1.00	1.00	0.63	0.63	0.63	0.09	0.09	0.09
Uniform Delay (d), s/veh	37.9	32.2	36.2	39.1	32.2	33.4	49.6	19.9	15.4	45.1	0.0	0.0
Incr Delay (d2), s/veh	0.7	0.2	1.4	1.1	0.2	0.5	12.4	0.2	0.1	228.4	0.2	0.1
Initial Q Delay(d3),s/veh	0.0	0.0	0.0	0.0	0.0	0.0	0.0	0.0	0.0	0.0	0.0	0.0
%ile Back of Q (50%), veh/ln	2.9	2.2	6.1	3.5	2.2	3.1	4.2	11.0	2.5	15.4	0.1	0.0
Lane Grp Delay (d), s/veh	38.6	32.4	37.7	40.3	32.4	33.9	62.0	20.1	15.5	273.6	0.2	0.1
Lane Grp LOS	D	C	D	D	C	C	E	C	B	F	A	A
Approach Vol, veh/h		460			370			2033			2711	
Approach Delay, s/veh		36.8			35.8			22.5			26.5	
Approach LOS		D			D			C			C	
Timer												
Assigned Phs		2			6		7	4		3		8
Phs Duration (G+Y+Rc), s		34.5			34.5		15.7	61.7		16.0		62.0
Change Period (Y+Rc), s		5.0			5.0		5.0	5.0		5.0		5.0
Max Green Setting (Gmax), s		37.0			37.0		11.0	57.0		11.0		57.0
Max Q Clear Time (g_c+I1), s		17.6			19.8		10.1	26.9		13.0		2.0
Green Ext Time (p_c), s		3.2			3.1		0.8	16.6		0.0		31.6
Intersection Summary												
HCM 2010 Ctrl Delay			26.5									
HCM 2010 LOS			C									
Notes												































HCM 2010 Signalized Intersection Summary
 102: Unser Blvd & Loop Rd N

Scheme D -- Year 2035 PM
 6/6/2013

												
Movement	SEL	SET	SER	NWL	NWT	NWR	NEL	NET	NER	SWL	SWT	SWR
Lane Configurations												
Volume (veh/h)	100	100	150	150	100	150	131	850	125	100	791	63
Number	1	6	16	5	2	12	7	4	14	3	8	18
Initial Q (Qb), veh	0	0	0	0	0	0	0	0	0	0	0	0
Ped-Bike Adj(A_pbT)	1.00		1.00	1.00		1.00	1.00		1.00	1.00		1.00
Parking Bus Adj	1.00	1.00	1.00	1.00	1.00	1.00	1.00	1.00	1.00	1.00	1.00	1.00
Adj Sat Flow veh/h/ln	186.3	186.3	186.3	186.3	186.3	186.3	186.3	186.3	186.3	186.3	186.3	186.3
Lanes	1	1	1	1	1	1	1	2	1	1	2	1
Cap, veh/h	261	403	343	261	403	343	458	2568	1091	411	2568	1091
Arrive On Green	0.22	0.22	0.22	0.22	0.22	0.22	0.69	0.69	0.69	0.69	0.69	0.69
Sat Flow, veh/h	1125	1863	1583	1125	1863	1583	644	3725	1583	574	3725	1583
Grp Volume(v), veh/h	100	100	150	150	100	150	131	850	125	100	791	63
Grp Sat Flow(s),veh/h/ln	1125	1863	1583	1125	1863	1583	644	1863	1583	574	1863	1583
Q Serve(g_s), s	8.6	4.7	8.7	13.5	4.7	8.7	10.7	9.7	2.8	9.0	8.9	1.4
Cycle Q Clear(g_c), s	13.3	4.7	8.7	18.2	4.7	8.7	19.6	9.7	2.8	18.7	8.9	1.4
Prop In Lane	1.00		1.00	1.00		1.00	1.00		1.00	1.00		1.00
Lane Grp Cap(c), veh/h	261	403	343	261	403	343	458	2568	1091	411	2568	1091
V/C Ratio(X)	0.38	0.25	0.44	0.57	0.25	0.44	0.29	0.33	0.11	0.24	0.31	0.06
Avail Cap(c_a), veh/h	411	651	553	411	651	553	458	2568	1091	411	2568	1091
HCM Platoon Ratio	1.00	1.00	1.00	1.00	1.00	1.00	1.00	1.00	1.00	1.00	1.00	1.00
Upstream Filter(I)	1.00	1.00	1.00	1.00	1.00	1.00	0.53	0.53	0.53	1.00	1.00	1.00
Uniform Delay (d), s/veh	39.9	34.4	35.9	41.9	34.4	35.9	10.4	6.6	5.6	10.4	6.5	5.3
Incr Delay (d2), s/veh	0.9	0.3	0.9	2.0	0.3	0.9	0.8	0.2	0.1	1.4	0.3	0.1
Initial Q Delay(d3),s/veh	0.0	0.0	0.0	0.0	0.0	0.0	0.0	0.0	0.0	0.0	0.0	0.0
%ile Back of Q (50%), veh/ln	2.5	2.3	3.5	4.0	2.3	3.5	1.6	3.7	0.9	1.3	3.4	0.5
Lane Grp Delay (d), s/veh	40.8	34.7	36.8	43.9	34.7	36.8	11.2	6.8	5.7	11.8	6.8	5.4
Lane Grp LOS	D	C	D	D	C	D	B	A	A	B	A	A
Approach Vol, veh/h		350			400			1106			954	
Approach Delay, s/veh		37.3			38.9			7.2			7.2	
Approach LOS		D			D			A			A	
Timer												
Assigned Phs		6			2			4			8	
Phs Duration (G+Y+Rc), s		27.9			27.9			78.0			78.0	
Change Period (Y+Rc), s		5.0			5.0			5.0			5.0	
Max Green Setting (Gmax), s		37.0			37.0			73.0			73.0	
Max Q Clear Time (g_c+I1), s		15.3			20.2			21.6			20.7	
Green Ext Time (p_c), s		2.9			2.7			19.0			19.1	
Intersection Summary												
HCM 2010 Ctrl Delay			15.5									
HCM 2010 LOS			B									
Notes												

























HCM 2010 Signalized Intersection Summary
 103: Loop Rd E/Loop Rd East & Paseo del Norte

Scheme D -- Year 2035 PM
 6/6/2013

												
Movement	SEL	SET	SER	NWL	NWT	NWR	NEL	NET	NER	SWL	SWT	SWR
Lane Configurations	 	  		 	  							
Volume (veh/h)	100	1900	250	262	2233	343	135	100	272	78	100	293
Number	7	4	14	3	8	18	5	2	12	1	6	16
Initial Q (Qb), veh	0	0	0	0	0	0	0	0	0	0	0	0
Ped-Bike Adj(A_pbT)	1.00		0.99	1.00		0.99	0.99		0.98	0.99		0.98
Parking Bus Adj	1.00	1.00	1.00	1.00	1.00	1.00	1.00	1.00	1.00	1.00	1.00	1.00
Adj Sat Flow veh/h/ln	167.6	167.6	174.4	167.6	167.6	174.4	167.6	167.6	167.6	167.6	167.6	167.6
Lanes	2	3	1	2	3	1	1	1	1	1	1	1
Cap, veh/h	316	2441	710	316	2441	710	270	470	391	274	470	391
Arrive On Green	0.10	0.49	0.49	0.10	0.49	0.49	0.28	0.28	0.28	0.28	0.28	0.28
Sat Flow, veh/h	3097	5029	1464	3097	5029	1464	878	1676	1395	895	1676	1395
Grp Volume(v), veh/h	100	1900	250	262	2233	343	135	100	272	78	100	293
Grp Sat Flow(s),veh/h/ln	1549	1676	1464	1549	1676	1464	878	1676	1395	895	1676	1395
Q Serve(g_s), s	3.4	35.4	12.0	9.4	46.6	17.8	15.8	5.2	19.8	8.3	5.2	21.7
Cycle Q Clear(g_c), s	3.4	35.4	12.0	9.4	46.6	17.8	20.9	5.2	19.8	13.5	5.2	21.7
Prop In Lane	1.00		1.00	1.00		1.00	1.00		1.00	1.00		1.00
Lane Grp Cap(c), veh/h	316	2441	710	316	2441	710	270	470	391	274	470	391
V/C Ratio(X)	0.32	0.78	0.35	0.83	0.91	0.48	0.50	0.21	0.70	0.29	0.21	0.75
Avail Cap(c_a), veh/h	355	2441	710	355	2441	710	310	547	455	315	547	455
HCM Platoon Ratio	1.00	1.00	1.00	1.00	1.00	1.00	1.00	1.00	1.00	1.00	1.00	1.00
Upstream Filter(I)	0.33	0.33	0.33	0.65	0.65	0.65	1.00	1.00	1.00	1.00	1.00	1.00
Uniform Delay (d), s/veh	47.2	24.1	18.1	49.9	27.0	19.6	39.2	31.2	36.4	36.3	31.2	37.1
Incr Delay (d2), s/veh	0.2	0.9	0.5	9.4	4.6	1.5	1.4	0.2	3.8	0.6	0.2	5.8
Initial Q Delay(d3),s/veh	0.0	0.0	0.0	0.0	0.0	0.0	0.0	0.0	0.0	0.0	0.0	0.0
%ile Back of Q (50%), veh/ln	1.3	14.3	4.3	4.1	19.4	6.5	3.6	2.2	7.2	1.9	2.2	8.1
Lane Grp Delay (d), s/veh	47.4	25.0	18.6	59.4	31.6	21.1	40.6	31.4	40.2	36.9	31.4	42.9
Lane Grp LOS	D	C	B	E	C	C	D	C	D	D	C	D
Approach Vol, veh/h		2250			2838			507			471	
Approach Delay, s/veh		25.3			32.9			38.6			39.5	
Approach LOS		C			C			D			D	
Timer												
Assigned Phs	7	4		3	8			2				6
Phs Duration (G+Y+Rc), s	16.5	60.0		16.5	60.0			36.8				36.8
Change Period (Y+Rc), s	5.0	5.0		5.0	5.0			5.0				5.0
Max Green Setting (Gmax), s	13.0	55.0		13.0	55.0			37.0				37.0
Max Q Clear Time (g_c+I1), s	5.4	37.4		11.4	48.6			22.9				23.7
Green Ext Time (p_c), s	6.4	12.9		0.1	5.8			3.5				3.4
Intersection Summary												
HCM 2010 Ctrl Delay			31.0									
HCM 2010 LOS			C									
Notes												

HCM 2010 Signalized Intersection Summary
104: Unser Blvd & Loop Rd S

Scheme D -- Year 2035 PM
6/6/2013

												
Movement	EBL	EBT	EBR	WBL	WBT	WBR	NBL	NBT	NBR	SBL	SBT	SBR
Lane Configurations												
Volume (veh/h)	50	100	180	180	100	100	121	1105	202	50	800	201
Number	7	4	14	3	8	18	5	2	12	1	6	16
Initial Q (Qb), veh	0	0	0	0	0	0	0	0	0	0	0	0
Ped-Bike Adj(A_pbT)	1.00		1.00	1.00		1.00	1.00		1.00	1.00		1.00
Parking Bus Adj	1.00	1.00	1.00	1.00	1.00	1.00	1.00	1.00	1.00	1.00	1.00	1.00
Adj Sat Flow veh/h/ln	186.3	186.3	186.3	186.3	186.3	186.3	186.3	186.3	186.3	186.3	186.3	186.3
Lanes	1	1	1	1	1	1	1	2	1	1	2	1
Cap, veh/h	435	639	543	410	639	543	316	2059	875	228	2059	875
Arrive On Green	0.34	0.34	0.34	0.34	0.34	0.34	0.55	0.55	0.55	0.55	0.55	0.55
Sat Flow, veh/h	1178	1863	1583	1095	1863	1583	561	3725	1583	419	3725	1583
Grp Volume(v), veh/h	50	100	180	180	100	100	121	1105	202	50	800	201
Grp Sat Flow(s),veh/h/ln	1178	1863	1583	1095	1863	1583	561	1863	1583	419	1863	1583
Q Serve(g_s), s	3.0	3.6	8.1	13.1	3.6	4.3	15.1	18.1	6.3	8.3	11.8	6.3
Cycle Q Clear(g_c), s	6.5	3.6	8.1	16.7	3.6	4.3	26.8	18.1	6.3	26.4	11.8	6.3
Prop In Lane	1.00		1.00	1.00		1.00	1.00		1.00	1.00		1.00
Lane Grp Cap(c), veh/h	435	639	543	410	639	543	316	2059	875	228	2059	875
V/C Ratio(X)	0.11	0.16	0.33	0.44	0.16	0.18	0.38	0.54	0.23	0.22	0.39	0.23
Avail Cap(c_a), veh/h	435	639	543	410	639	543	455	2984	1268	332	2984	1268
HCM Platoon Ratio	1.00	1.00	1.00	1.00	1.00	1.00	1.00	1.00	1.00	1.00	1.00	1.00
Upstream Filter(I)	1.00	1.00	1.00	1.00	1.00	1.00	0.46	0.46	0.46	0.66	0.66	0.66
Uniform Delay (d), s/veh	24.2	21.9	23.4	27.7	21.9	22.1	19.9	13.7	11.0	22.1	12.2	11.0
Incr Delay (d2), s/veh	0.5	0.5	1.6	3.4	0.5	0.7	0.4	0.1	0.1	0.3	0.1	0.1
Initial Q Delay(d3),s/veh	0.0	0.0	0.0	0.0	0.0	0.0	0.0	0.0	0.0	0.0	0.0	0.0
%ile Back of Q (50%), veh/ln	0.9	1.8	3.4	3.9	1.8	1.8	2.0	7.4	2.1	0.9	4.8	2.1
Lane Grp Delay (d), s/veh	24.7	22.4	25.0	31.1	22.4	22.9	20.2	13.8	11.1	22.4	12.3	11.1
Lane Grp LOS	C	C	C	C	C	C	C	B	B	C	B	B
Approach Vol, veh/h		330			380			1428			1051	
Approach Delay, s/veh		24.2			26.7			13.9			12.6	
Approach LOS		C			C			B			B	
Timer												
Assigned Phs		4			8			2			6	
Phs Duration (G+Y+Rc), s		38.0			38.0			58.1			58.1	
Change Period (Y+Rc), s		5.0			5.0			5.0			5.0	
Max Green Setting (Gmax), s		33.0			33.0			77.0			77.0	
Max Q Clear Time (g_c+I1), s		10.1			18.7			28.8			28.4	
Green Ext Time (p_c), s		2.8			2.5			24.3			24.4	
Intersection Summary												
HCM 2010 Ctrl Delay				16.1								
HCM 2010 LOS				B								
Notes												

HCM 2010 Signalized Intersection Summary
 105: Paseo del Norte & Transit Blvd

Scheme D -- Year 2035 PM
 6/6/2013

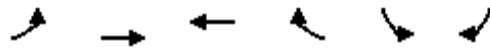

Movement	EBL	EBT	WBT	WBR	SBL	SBR
Lane Configurations						
Volume (veh/h)	150	2100	2626	143	150	212
Number	7	4	8	18	1	16
Initial Q (Qb), veh	0	0	0	0	0	0
Ped-Bike Adj(A_pbT)	1.00			1.00	1.00	1.00
Parking Bus Adj	1.00	1.00	1.00	1.00	1.00	1.00
Adj Sat Flow veh/h/ln	186.3	186.3	186.3	186.3	186.3	186.3
Lanes	2	3	3	1	1	1
Cap, veh/h	288	4123	4123	1168	286	255
Arrive On Green	0.74	0.74	1.00	1.00	0.16	0.16
Sat Flow, veh/h	194	5588	5588	1583	1774	1583
Grp Volume(v), veh/h	150	2100	2626	143	150	212
Grp Sat Flow(s),veh/h/ln	97	1863	1863	1583	1774	1583
Q Serve(g_s), s	73.0	15.6	0.0	0.0	7.7	12.8
Cycle Q Clear(g_c), s	73.0	15.6	0.0	0.0	7.7	12.8
Prop In Lane	1.00			1.00	1.00	1.00
Lane Grp Cap(c), veh/h	288	4123	4123	1168	286	255
V/C Ratio(X)	0.52	0.51	0.64	0.12	0.52	0.83
Avail Cap(c_a), veh/h	288	4123	4123	1168	663	592
HCM Platoon Ratio	1.00	1.00	2.00	2.00	1.00	1.00
Upstream Filter(I)	0.61	0.61	0.39	0.39	1.00	1.00
Uniform Delay (d), s/veh	14.7	5.5	0.0	0.0	38.0	40.2
Incr Delay (d2), s/veh	1.0	0.1	0.3	0.1	1.5	6.9
Initial Q Delay(d3),s/veh	0.0	0.0	0.0	0.0	0.0	0.0
%ile Back of Q (50%), veh/ln	1.6	5.3	0.1	0.0	3.6	5.6
Lane Grp Delay (d), s/veh	15.7	5.5	0.3	0.1	39.5	47.0
Lane Grp LOS	B	A	A	A	D	D
Approach Vol, veh/h		2250	2769		362	
Approach Delay, s/veh		6.2	0.3		43.9	
Approach LOS		A	A		D	
Timer						
Assigned Phs		4	8			
Phs Duration (G+Y+Rc), s		78.0	78.0			
Change Period (Y+Rc), s		5.0	5.0			
Max Green Setting (Gmax), s		73.0	73.0			
Max Q Clear Time (g_c+I1), s		75.0	2.0			
Green Ext Time (p_c), s		0.0	68.9			
Intersection Summary						
HCM 2010 Ctrl Delay			5.7			
HCM 2010 LOS			A			
Notes						

Appendix B

Synchro Outputs: Signal Phasing

Timing Report, Sorted By Phase
11: Universe & Paseo del Norte

Scheme A -- Year 2035 PM

6/1/2013

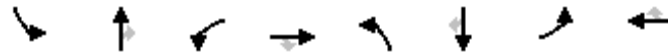

Phase Number	1	2	3	4	5	6	7	8
Movement	SBL	NBT	WBL	EBT	NBL	SBT	EBL	WBT
Lead/Lag	Lead	Lag	Lead	Lag	Lead	Lag	Lag	Lead
Lead-Lag Optimize	Yes	Yes	Yes	Yes	Yes	Yes	Yes	Yes
Recall Mode	None	None	None	None	None	None	None	C-Max
Maximum Split (s)	11.5	42	11.5	55	11.5	42	11.5	55
Maximum Split (%)	9.6%	35.0%	9.6%	45.8%	9.6%	35.0%	9.6%	45.8%
Minimum Split (s)	9	42	9	35	9	42	9	35
Yellow Time (s)	3.5	4	3.5	4	3.5	4	3.5	4
All-Red Time (s)	1	1	1	1	1	1	1	1
Minimum Initial (s)	4	4	4	4	4	4	4	4
Vehicle Extension (s)	3	3	3	3	3	3	3	3
Minimum Gap (s)	3	3	3	3	3	3	3	3
Time Before Reduce (s)	0	0	0	0	0	0	0	0
Time To Reduce (s)	0	0	0	0	0	0	0	0
Walk Time (s)		7		7		7		7
Flash Dont Walk (s)		30		23		30		23
Dual Entry	No	Yes	No	Yes	No	Yes	No	Yes
Inhibit Max	Yes	Yes	Yes	Yes	Yes	Yes	Yes	Yes
Start Time (s)	6.5	18	60	71.5	6.5	18	115	60
End Time (s)	18	60	71.5	6.5	18	60	6.5	115
Yield/Force Off (s)	13.5	55	67	1.5	13.5	55	2	110
Yield/Force Off 170(s)	13.5	25	67	98.5	13.5	25	2	87
Local Start Time (s)	66.5	78	0	11.5	66.5	78	55	0
Local Yield (s)	73.5	115	7	61.5	73.5	115	62	50
Local Yield 170(s)	73.5	85	7	38.5	73.5	85	62	27

Intersection Summary

Cycle Length	120
Control Type	Actuated-Coordinated
Natural Cycle	115
Offset: 60 (50%), Referenced to phase 8:WBT, Start of Green	

Splits and Phases: 11: Universe & Paseo del Norte

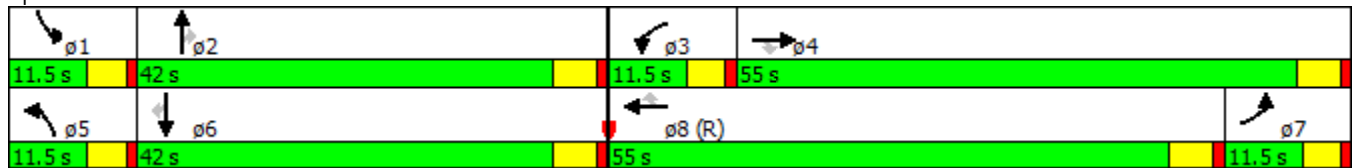

Timing Report, Sorted By Phase
12: Unser Blvd & Paseo del Norte

Scheme A -- Year 2035 PM

6/1/2013



Phase Number	1	2	3	4	5	6	7	8
Movement	SWL	NETL	NWL	SET	NEL	SWTL	SEL	NWT
Lead/Lag	Lead	Lag	Lead	Lag	Lead	Lag	Lead	Lag
Lead-Lag Optimize	Yes	Yes	Yes	Yes	Yes	Yes	Yes	Yes
Recall Mode	None	None	None	Max	None	None	None	C-Max
Maximum Split (s)	13	42	15	50	13	42	15	50
Maximum Split (%)	10.8%	35.0%	12.5%	41.7%	10.8%	35.0%	12.5%	41.7%
Minimum Split (s)	9	42	9	41	9	42	9	41
Yellow Time (s)	4	4	4	4	4	4	4	4
All-Red Time (s)	1	1	1	1	1	1	1	1
Minimum Initial (s)	4	4	4	4	4	4	4	4
Vehicle Extension (s)	3	3	3	3	3	3	3	3
Minimum Gap (s)	3	3	3	3	3	3	3	3
Time Before Reduce (s)	0	0	0	0	0	0	0	0
Time To Reduce (s)	0	0	0	0	0	0	0	0
Walk Time (s)		7		7		7		7
Flash Dont Walk (s)		30		29		30		29
Dual Entry	No	Yes	No	Yes	No	Yes	No	Yes
Inhibit Max	Yes	Yes	Yes	Yes	Yes	Yes	Yes	Yes
Start Time (s)	50	63	105	0	50	63	105	0
End Time (s)	63	105	0	50	63	105	0	50
Yield/Force Off (s)	58	100	115	45	58	100	115	45
Yield/Force Off 170(s)	58	70	115	16	58	70	115	16
Local Start Time (s)	50	63	105	0	50	63	105	0
Local Yield (s)	58	100	115	45	58	100	115	45
Local Yield 170(s)	58	70	115	16	58	70	115	16

Intersection Summary

Cycle Length	120
Control Type	Actuated-Coordinated
Natural Cycle	125
Offset: 0 (0%), Referenced to phase 8:NWT, Start of Green, Master Intersection	

Splits and Phases: 12: Unser Blvd & Paseo del Norte

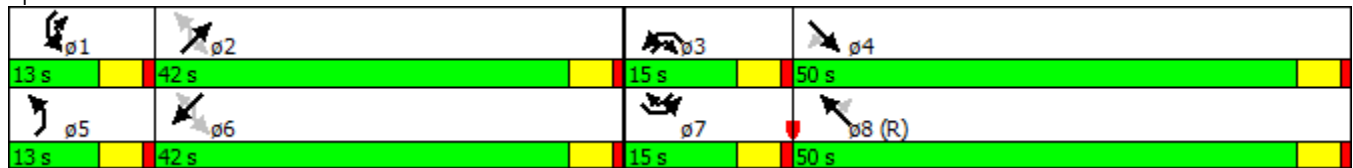

Timing Report, Sorted By Phase
 13: Kimmick Rd & Paseo del Norte

Scheme A -- Year 2035 PM

6/1/2013

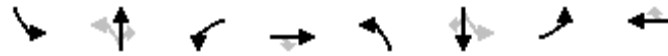

Phase Number	1	2	3	4	5	6	7	8
Movement	SBL	NBTL	WBL	EBT	NBL	SBTL	EBL	WBT
Lead/Lag	Lead	Lag	Lead	Lag	Lead	Lag	Lead	Lag
Lead-Lag Optimize	Yes	Yes			Yes	Yes	Yes	
Recall Mode	None	None	None	C-Min	None	None	None	C-Max
Maximum Split (s)	10	42	17	51	10	42	17	51
Maximum Split (%)	8.3%	35.0%	14.2%	42.5%	8.3%	35.0%	14.2%	42.5%
Minimum Split (s)	9	42	9.5	23	9	42	9.5	23
Yellow Time (s)	4	4	4	4	4	4	4	4
All-Red Time (s)	1	1	1	1	1	1	1	1
Minimum Initial (s)	4	4	4	4	4	4	4	4
Vehicle Extension (s)	3	3	3	3	3	3	3	3
Minimum Gap (s)	3	3	3	3	3	3	3	3
Time Before Reduce (s)	0	0	0	0	0	0	0	0
Time To Reduce (s)	0	0	0	0	0	0	0	0
Walk Time (s)		7		7		7		7
Flash Dont Walk (s)		30		11		30		11
Dual Entry	No	Yes	No	Yes	No	Yes	No	Yes
Inhibit Max	Yes	Yes	Yes	Yes	Yes	Yes	Yes	Yes
Start Time (s)	111	1	43	60	111	1	43	60
End Time (s)	1	43	60	111	1	43	60	111
Yield/Force Off (s)	116	38	55	106	116	38	55	106
Yield/Force Off 170(s)	116	8	55	95	116	8	55	95
Local Start Time (s)	51	61	103	0	51	61	103	0
Local Yield (s)	56	98	115	46	56	98	115	46
Local Yield 170(s)	56	68	115	35	56	68	115	35

Intersection Summary

Cycle Length	120
Control Type	Actuated-Coordinated
Natural Cycle	135
Offset: 60 (50%), Referenced to phase 4:EBT and 8:WBT, Start of Green	

Splits and Phases: 13: Kimmick Rd & Paseo del Norte

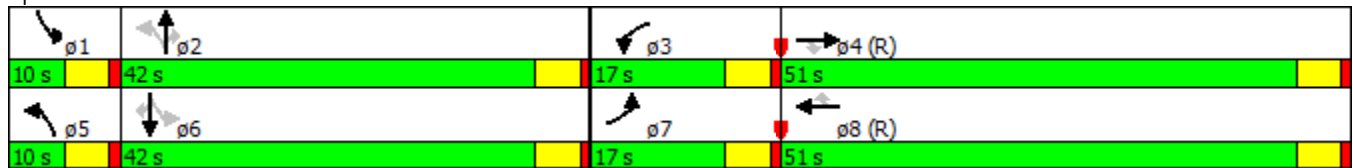

Timing Report, Sorted By Phase
 14: Transit Blvd & Unser Blvd

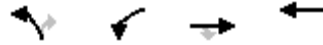

Phase Number	2	3	4	8
Movement	NBL	WBL	EBT	WBT
Lead/Lag		Lead	Lag	
Lead-Lag Optimize		Yes	Yes	
Recall Mode	Max	None	C-Max	None
Maximum Split (s)	42	23	55	55
Maximum Split (%)	35.0%	19.2%	45.8%	45.8%
Minimum Split (s)	37	9.5	23	23
Yellow Time (s)	4	4	4	4
All-Red Time (s)	1	1	1	1
Minimum Initial (s)	4	4	4	4
Vehicle Extension (s)	3	3	3	3
Minimum Gap (s)	3	3	3	3
Time Before Reduce (s)	0	0	0	0
Time To Reduce (s)	0	0	0	0
Walk Time (s)	7		7	7
Flash Dont Walk (s)	25		11	11
Dual Entry	Yes	No	Yes	Yes
Inhibit Max	Yes	Yes	Yes	Yes
Start Time (s)	55	97	0	97
End Time (s)	97	0	55	55
Yield/Force Off (s)	92	115	50	50
Yield/Force Off 170(s)	67	115	39	39
Local Start Time (s)	55	97	0	97
Local Yield (s)	92	115	50	50
Local Yield 170(s)	67	115	39	39

Intersection Summary

Cycle Length	120
Control Type	Actuated-Coordinated
Natural Cycle	75
Offset: 0 (0%), Referenced to phase 4:EBT, Start of Green	

Splits and Phases: 14: Transit Blvd & Unser Blvd

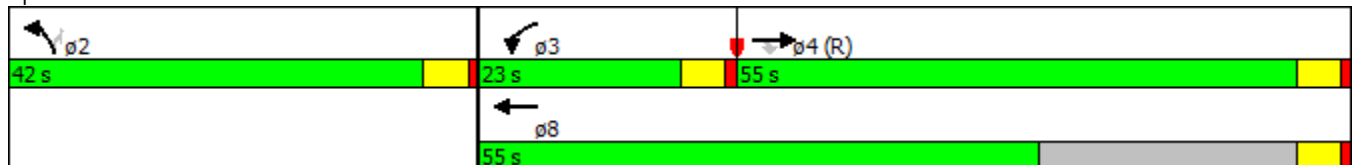

Timing Report, Sorted By Phase
 101: Paseo del Norte & Loop Rd W/Loop Rd N

Scheme A -- Year 2035 PM
 6/1/2013



Phase Number	2	3	4	6	7	8
Movement	EBTL	NWL	SET	WBTL	SEL	NWT
Lead/Lag		Lead	Lag		Lag	Lead
Lead-Lag Optimize		Yes	Yes		Yes	Yes
Recall Mode	None	None	Min	None	None	C-Max
Maximum Split (s)	42	16	62	42	16	62
Maximum Split (%)	35.0%	13.3%	51.7%	35.0%	13.3%	51.7%
Minimum Split (s)	27	9	27	42	9	42
Yellow Time (s)	4	4	4	4	4	4
All-Red Time (s)	1	1	1	1	1	1
Minimum Initial (s)	4	4	4	4	4	4
Vehicle Extension (s)	3	3	3	3	3	3
Minimum Gap (s)	3	3	3	3	3	3
Time Before Reduce (s)	0	0	0	0	0	0
Time To Reduce (s)	0	0	0	0	0	0
Walk Time (s)	7		7	7		7
Flash Dont Walk (s)	15		15	30		30
Dual Entry	Yes	No	Yes	Yes	No	Yes
Inhibit Max	Yes	Yes	Yes	Yes	Yes	Yes
Start Time (s)	98	20	36	98	82	20
End Time (s)	20	36	98	20	98	82
Yield/Force Off (s)	15	31	93	15	93	77
Yield/Force Off 170(s)	0	31	93	105	93	47
Local Start Time (s)	78	0	16	78	62	0
Local Yield (s)	115	11	73	115	73	57
Local Yield 170(s)	100	11	73	85	73	27

Intersection Summary

Cycle Length	120
Control Type	Actuated-Coordinated
Natural Cycle	105
Offset: 20 (17%), Referenced to phase 8:NWT, Start of Green	

Splits and Phases: 101: Paseo del Norte & Loop Rd W/Loop Rd N

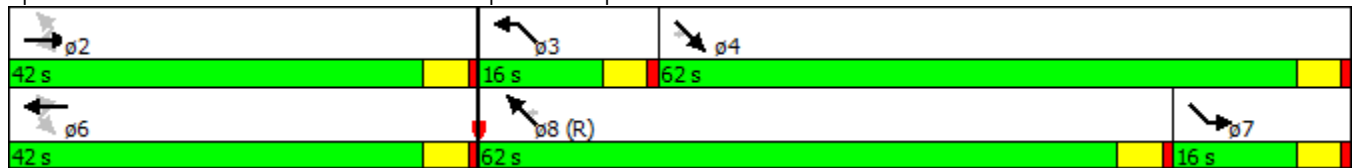

Timing Report, Sorted By Phase
102: Unser Blvd & Loop Rd N

Scheme A -- Year 2035 PM

6/1/2013



Phase Number	2	4	6	8
Movement	NWTL	NETL	SETL	SWTL
Lead/Lag				
Lead-Lag Optimize				
Recall Mode	None	C-Max	None	C-Max
Maximum Split (s)	42	78	42	78
Maximum Split (%)	35.0%	65.0%	35.0%	65.0%
Minimum Split (s)	23	23	23	23
Yellow Time (s)	4	4	4	4
All-Red Time (s)	1	1	1	1
Minimum Initial (s)	4	4	4	4
Vehicle Extension (s)	3	3	3	3
Minimum Gap (s)	3	3	3	3
Time Before Reduce (s)	0	0	0	0
Time To Reduce (s)	0	0	0	0
Walk Time (s)	7	7	7	7
Flash Dont Walk (s)	11	11	11	11
Dual Entry	Yes	Yes	Yes	Yes
Inhibit Max	Yes	Yes	Yes	Yes
Start Time (s)	18	60	18	60
End Time (s)	60	18	60	18
Yield/Force Off (s)	55	13	55	13
Yield/Force Off 170(s)	44	2	44	2
Local Start Time (s)	78	0	78	0
Local Yield (s)	115	73	115	73
Local Yield 170(s)	104	62	104	62

Intersection Summary

Cycle Length	120
Control Type	Actuated-Coordinated
Natural Cycle	50
Offset: 60 (50%), Referenced to phase 4:NETL and 8:SWTL, Start of Green	

Splits and Phases: 102: Unser Blvd & Loop Rd N

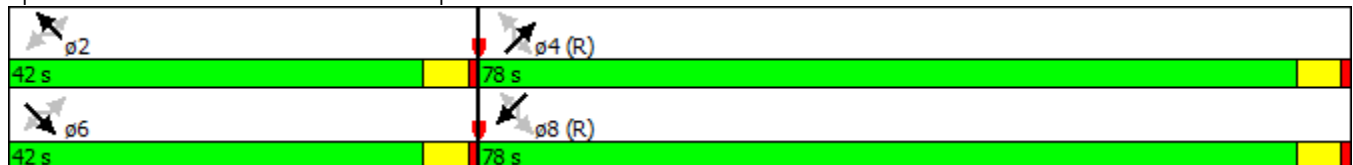

Timing Report, Sorted By Phase
 103: Avenita de Jaimito/Loop Rd East & Paseo del Norte



Phase Number	2	3	4	6	7	8
Movement	NETL	NWL	SET	SWTL	SEL	NWT
Lead/Lag		Lead	Lag		Lag	Lead
Lead-Lag Optimize		Yes	Yes			
Recall Mode	None	None	Max	None	None	C-Max
Maximum Split (s)	42	18	60	42	18	60
Maximum Split (%)	35.0%	15.0%	50.0%	35.0%	15.0%	50.0%
Minimum Split (s)	42	9	27	42	9	27
Yellow Time (s)	4	4	4	4	4	4
All-Red Time (s)	1	1	1	1	1	1
Minimum Initial (s)	4	4	4	4	4	4
Vehicle Extension (s)	3	3	3	3	3	3
Minimum Gap (s)	3	3	3	3	3	3
Time Before Reduce (s)	0	0	0	0	0	0
Time To Reduce (s)	0	0	0	0	0	0
Walk Time (s)	7		7	7		7
Flash Dont Walk (s)	30		15	30		15
Dual Entry	Yes	No	Yes	Yes	No	Yes
Inhibit Max	Yes	Yes	Yes	Yes	Yes	Yes
Start Time (s)	88	10	28	88	70	10
End Time (s)	10	28	88	10	88	70
Yield/Force Off (s)	5	23	83	5	83	65
Yield/Force Off 170(s)	95	23	68	95	83	50
Local Start Time (s)	78	0	18	78	60	0
Local Yield (s)	115	13	73	115	73	55
Local Yield 170(s)	85	13	58	85	73	40

Intersection Summary

Cycle Length	120
Control Type	Actuated-Coordinated
Natural Cycle	110
Offset: 10 (8%), Referenced to phase 8:NWT, Start of Green	

Splits and Phases: 103: Avenita de Jaimito/Loop Rd East & Paseo del Norte

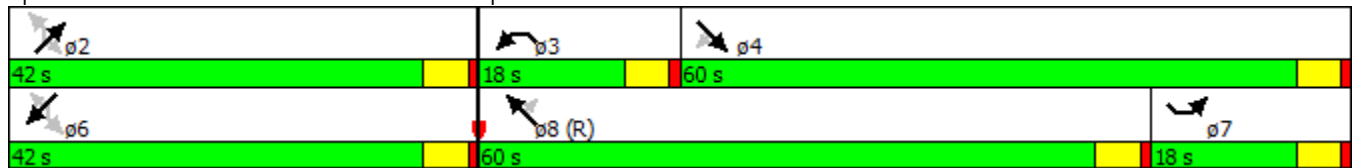

Timing Report, Sorted By Phase
 104: Unser Blvd & Loop Rd W/Avenida de Jaimito



Phase Number	2	4	6	8
Movement	NBTL	EBTL	SBTL	WBTL
Lead/Lag				
Lead-Lag Optimize				
Recall Mode	None	C-Max	None	C-Max
Maximum Split (s)	82	38	82	38
Maximum Split (%)	68.3%	31.7%	68.3%	31.7%
Minimum Split (s)	23	23	23	23
Yellow Time (s)	4	4	4	4
All-Red Time (s)	1	1	1	1
Minimum Initial (s)	4	4	4	4
Vehicle Extension (s)	3	3	3	3
Minimum Gap (s)	3	3	3	3
Time Before Reduce (s)	0	0	0	0
Time To Reduce (s)	0	0	0	0
Walk Time (s)	7	7	7	7
Flash Dont Walk (s)	11	11	11	11
Dual Entry	Yes	Yes	Yes	Yes
Inhibit Max	Yes	Yes	Yes	Yes
Start Time (s)	38	0	38	0
End Time (s)	0	38	0	38
Yield/Force Off (s)	115	33	115	33
Yield/Force Off 170(s)	104	22	104	22
Local Start Time (s)	38	0	38	0
Local Yield (s)	115	33	115	33
Local Yield 170(s)	104	22	104	22

Intersection Summary

Cycle Length	120
Control Type	Actuated-Coordinated
Natural Cycle	50
Offset: 0 (0%), Referenced to phase 4:EBTL and 8:WBTL, Start of Green	

Splits and Phases: 104: Unser Blvd & Loop Rd W/Avenida de Jaimito



Timing Report, Sorted By Phase
11: Universe & Paseo del Norte

Scheme B -- Year 2035 PM

6/1/2013



Phase Number	1	2	3	4	5	6	7	8
Movement	SBL	NBT	WBL	EBT	NBL	SBT	EBL	WBT
Lead/Lag	Lead	Lag	Lead	Lag	Lead	Lag	Lag	Lead
Lead-Lag Optimize	Yes	Yes	Yes	Yes	Yes	Yes	Yes	Yes
Recall Mode	None	None	None	None	None	None	None	C-Max
Maximum Split (s)	11.5	42	11.5	55	11.5	42	11.5	55
Maximum Split (%)	9.6%	35.0%	9.6%	45.8%	9.6%	35.0%	9.6%	45.8%
Minimum Split (s)	9	42	9	35	9	42	9	35
Yellow Time (s)	3.5	4	3.5	4	3.5	4	3.5	4
All-Red Time (s)	1	1	1	1	1	1	1	1
Minimum Initial (s)	4	4	4	4	4	4	4	4
Vehicle Extension (s)	3	3	3	3	3	3	3	3
Minimum Gap (s)	3	3	3	3	3	3	3	3
Time Before Reduce (s)	0	0	0	0	0	0	0	0
Time To Reduce (s)	0	0	0	0	0	0	0	0
Walk Time (s)		7		7		7		7
Flash Dont Walk (s)		30		23		30		23
Dual Entry	No	Yes	No	Yes	No	Yes	No	Yes
Inhibit Max	Yes	Yes	Yes	Yes	Yes	Yes	Yes	Yes
Start Time (s)	6.5	18	60	71.5	6.5	18	115	60
End Time (s)	18	60	71.5	6.5	18	60	6.5	115
Yield/Force Off (s)	13.5	55	67	1.5	13.5	55	2	110
Yield/Force Off 170(s)	13.5	25	67	98.5	13.5	25	2	87
Local Start Time (s)	66.5	78	0	11.5	66.5	78	55	0
Local Yield (s)	73.5	115	7	61.5	73.5	115	62	50
Local Yield 170(s)	73.5	85	7	38.5	73.5	85	62	27

Intersection Summary

Cycle Length	120
Control Type	Actuated-Coordinated
Natural Cycle	115
Offset: 60 (50%), Referenced to phase 8:WBT, Start of Green	

Splits and Phases: 11: Universe & Paseo del Norte

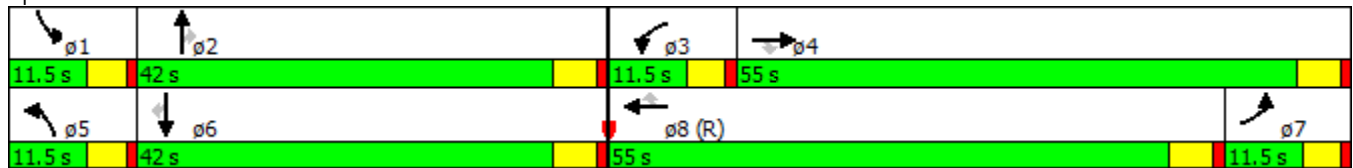

Timing Report, Sorted By Phase
12: Unser Blvd & Paseo del Norte

Scheme B -- Year 2035 PM

6/1/2013



Phase Number	1	2	3	4	5	6	7	8
Movement	SWL	NETL	NWL	SET	NEL	SWTL	SEL	NWT
Lead/Lag	Lead	Lag	Lead	Lag	Lead	Lag	Lead	Lag
Lead-Lag Optimize	Yes	Yes	Yes	Yes	Yes	Yes	Yes	Yes
Recall Mode	None	None	None	Max	None	None	None	C-Max
Maximum Split (s)	13	42	20	45	13	42	20	45
Maximum Split (%)	10.8%	35.0%	16.7%	37.5%	10.8%	35.0%	16.7%	37.5%
Minimum Split (s)	9	42	9	41	9	42	9	41
Yellow Time (s)	4	4	4	4	4	4	4	4
All-Red Time (s)	1	1	1	1	1	1	1	1
Minimum Initial (s)	4	4	4	4	4	4	4	4
Vehicle Extension (s)	3	3	3	3	3	3	3	3
Minimum Gap (s)	3	3	3	3	3	3	3	3
Time Before Reduce (s)	0	0	0	0	0	0	0	0
Time To Reduce (s)	0	0	0	0	0	0	0	0
Walk Time (s)		7		7		7		7
Flash Dont Walk (s)		30		29		30		29
Dual Entry	No	Yes	No	Yes	No	Yes	No	Yes
Inhibit Max	Yes	Yes	Yes	Yes	Yes	Yes	Yes	Yes
Start Time (s)	45	58	100	0	45	58	100	0
End Time (s)	58	100	0	45	58	100	0	45
Yield/Force Off (s)	53	95	115	40	53	95	115	40
Yield/Force Off 170(s)	53	65	115	11	53	65	115	11
Local Start Time (s)	45	58	100	0	45	58	100	0
Local Yield (s)	53	95	115	40	53	95	115	40
Local Yield 170(s)	53	65	115	11	53	65	115	11

Intersection Summary

Cycle Length	120
Control Type	Actuated-Coordinated
Natural Cycle	135
Offset: 0 (0%), Referenced to phase 8:NWT, Start of Green, Master Intersection	

Splits and Phases: 12: Unser Blvd & Paseo del Norte

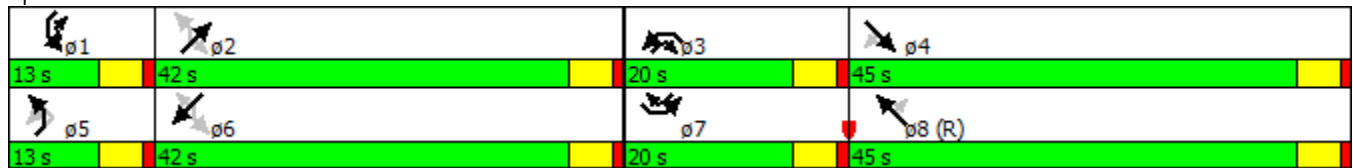

Timing Report, Sorted By Phase
 13: Kimmick Rd & Paseo del Norte

Scheme B -- Year 2035 PM

6/1/2013

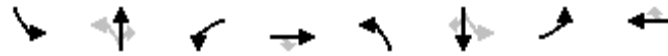

Phase Number	1	2	3	4	5	6	7	8
Movement	SBL	NBTL	WBL	EBT	NBL	SBTL	EBL	WBT
Lead/Lag	Lead	Lag	Lead	Lag	Lead	Lag	Lead	Lag
Lead-Lag Optimize	Yes	Yes			Yes	Yes	Yes	
Recall Mode	None	None	None	C-Min	None	None	None	C-Max
Maximum Split (s)	12	42	15	51	12	42	15	51
Maximum Split (%)	10.0%	35.0%	12.5%	42.5%	10.0%	35.0%	12.5%	42.5%
Minimum Split (s)	9	42	9.5	23	9	42	9.5	23
Yellow Time (s)	4	4	4	4	4	4	4	4
All-Red Time (s)	1	1	1	1	1	1	1	1
Minimum Initial (s)	4	4	4	4	4	4	4	4
Vehicle Extension (s)	3	3	3	3	3	3	3	3
Minimum Gap (s)	3	3	3	3	3	3	3	3
Time Before Reduce (s)	0	0	0	0	0	0	0	0
Time To Reduce (s)	0	0	0	0	0	0	0	0
Walk Time (s)		7		7		7		7
Flash Dont Walk (s)		30		11		30		11
Dual Entry	No	Yes	No	Yes	No	Yes	No	Yes
Inhibit Max	Yes	Yes	Yes	Yes	Yes	Yes	Yes	Yes
Start Time (s)	111	3	45	60	111	3	45	60
End Time (s)	3	45	60	111	3	45	60	111
Yield/Force Off (s)	118	40	55	106	118	40	55	106
Yield/Force Off 170(s)	118	10	55	95	118	10	55	95
Local Start Time (s)	51	63	105	0	51	63	105	0
Local Yield (s)	58	100	115	46	58	100	115	46
Local Yield 170(s)	58	70	115	35	58	70	115	35

Intersection Summary

Cycle Length	120
Control Type	Actuated-Coordinated
Natural Cycle	145
Offset: 60 (50%), Referenced to phase 4:EBT and 8:WBT, Start of Green	

Splits and Phases: 13: Kimmick Rd & Paseo del Norte

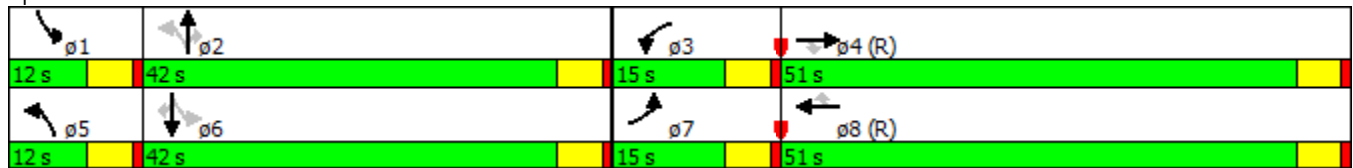

Timing Report, Sorted By Phase
 14: Transit Blvd & Unser Blvd



Phase Number	2	3	4	7	8
Movement	NBL	WBL	EBT	EBU	WBT
Lead/Lag		Lead	Lag	Lead	Lag
Lead-Lag Optimize		Yes	Yes	Yes	Yes
Recall Mode	Max	None	C-Max	None	None
Maximum Split (s)	42	23	55	23	55
Maximum Split (%)	35.0%	19.2%	45.8%	19.2%	45.8%
Minimum Split (s)	37	9.5	23	9	23
Yellow Time (s)	4	4	4	4	4
All-Red Time (s)	1	1	1	1	1
Minimum Initial (s)	4	4	4	4	4
Vehicle Extension (s)	3	3	3	3	3
Minimum Gap (s)	3	3	3	3	3
Time Before Reduce (s)	0	0	0	0	0
Time To Reduce (s)	0	0	0	0	0
Walk Time (s)	7		7		7
Flash Dont Walk (s)	25		11		11
Dual Entry	Yes	No	Yes	No	Yes
Inhibit Max	Yes	Yes	Yes	Yes	Yes
Start Time (s)	55	97	0	97	0
End Time (s)	97	0	55	0	55
Yield/Force Off (s)	92	115	50	115	50
Yield/Force Off 170(s)	67	115	39	115	39
Local Start Time (s)	55	97	0	97	0
Local Yield (s)	92	115	50	115	50
Local Yield 170(s)	67	115	39	115	39

Intersection Summary

Cycle Length	120
Control Type	Actuated-Coordinated
Natural Cycle	75
Offset: 0 (0%), Referenced to phase 4:EBT, Start of Green	

Splits and Phases: 14: Transit Blvd & Unser Blvd

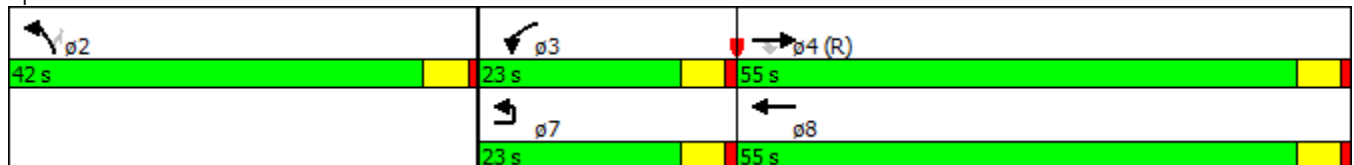

Timing Report, Sorted By Phase
 11: Universe & Paseo del Norte

Scheme C -- Year 2035 PM

6/1/2013

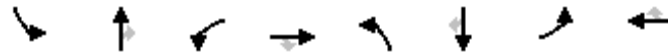

Phase Number	1	2	3	4	5	6	7	8
Movement	SBL	NBT	WBL	EBT	NBL	SBT	EBL	WBT
Lead/Lag	Lead	Lag	Lead	Lag	Lead	Lag	Lag	Lead
Lead-Lag Optimize	Yes	Yes	Yes	Yes	Yes	Yes	Yes	Yes
Recall Mode	None	None	None	None	None	None	None	C-Max
Maximum Split (s)	11.5	42	11.5	55	11.5	42	11.5	55
Maximum Split (%)	9.6%	35.0%	9.6%	45.8%	9.6%	35.0%	9.6%	45.8%
Minimum Split (s)	9	42	9	35	9	42	9	35
Yellow Time (s)	3.5	4	3.5	4	3.5	4	3.5	4
All-Red Time (s)	1	1	1	1	1	1	1	1
Minimum Initial (s)	4	4	4	4	4	4	4	4
Vehicle Extension (s)	3	3	3	3	3	3	3	3
Minimum Gap (s)	3	3	3	3	3	3	3	3
Time Before Reduce (s)	0	0	0	0	0	0	0	0
Time To Reduce (s)	0	0	0	0	0	0	0	0
Walk Time (s)		7		7		7		7
Flash Dont Walk (s)		30		23		30		23
Dual Entry	No	Yes	No	Yes	No	Yes	No	Yes
Inhibit Max	Yes	Yes	Yes	Yes	Yes	Yes	Yes	Yes
Start Time (s)	6.5	18	60	71.5	6.5	18	115	60
End Time (s)	18	60	71.5	6.5	18	60	6.5	115
Yield/Force Off (s)	13.5	55	67	1.5	13.5	55	2	110
Yield/Force Off 170(s)	13.5	25	67	98.5	13.5	25	2	87
Local Start Time (s)	66.5	78	0	11.5	66.5	78	55	0
Local Yield (s)	73.5	115	7	61.5	73.5	115	62	50
Local Yield 170(s)	73.5	85	7	38.5	73.5	85	62	27

Intersection Summary

Cycle Length	120
Control Type	Actuated-Coordinated
Natural Cycle	115
Offset: 60 (50%), Referenced to phase 8:WBT, Start of Green	

Splits and Phases: 11: Universe & Paseo del Norte

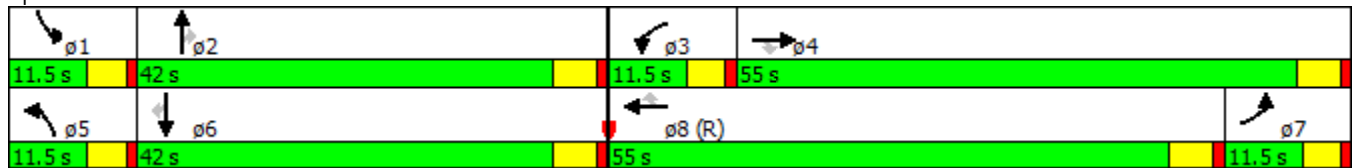

Timing Report, Sorted By Phase
12: Unser Blvd & Paseo del Norte

Scheme C -- Year 2035 PM

6/1/2013



Phase Number	1	2	3	4	5	6	7	8
Movement	SWL	NETL	NWL	SET	NEL	SWTL	SEL	NWT
Lead/Lag	Lead	Lag	Lead	Lag	Lead	Lag	Lead	Lag
Lead-Lag Optimize	Yes	Yes	Yes	Yes	Yes	Yes	Yes	Yes
Recall Mode	None	None	None	Max	None	None	None	C-Max
Maximum Split (s)	13	42	15	50	13	42	15	50
Maximum Split (%)	10.8%	35.0%	12.5%	41.7%	10.8%	35.0%	12.5%	41.7%
Minimum Split (s)	9	42	9	41	9	42	9	41
Yellow Time (s)	4	4	4	4	4	4	4	4
All-Red Time (s)	1	1	1	1	1	1	1	1
Minimum Initial (s)	4	4	4	4	4	4	4	4
Vehicle Extension (s)	3	3	3	3	3	3	3	3
Minimum Gap (s)	3	3	3	3	3	3	3	3
Time Before Reduce (s)	0	0	0	0	0	0	0	0
Time To Reduce (s)	0	0	0	0	0	0	0	0
Walk Time (s)		7		7		7		7
Flash Dont Walk (s)		30		29		30		29
Dual Entry	No	Yes	No	Yes	No	Yes	No	Yes
Inhibit Max	Yes	Yes	Yes	Yes	Yes	Yes	Yes	Yes
Start Time (s)	50	63	105	0	50	63	105	0
End Time (s)	63	105	0	50	63	105	0	50
Yield/Force Off (s)	58	100	115	45	58	100	115	45
Yield/Force Off 170(s)	58	70	115	16	58	70	115	16
Local Start Time (s)	50	63	105	0	50	63	105	0
Local Yield (s)	58	100	115	45	58	100	115	45
Local Yield 170(s)	58	70	115	16	58	70	115	16

Intersection Summary

Cycle Length	120
Control Type	Actuated-Coordinated
Natural Cycle	125
Offset: 0 (0%), Referenced to phase 8:NWT, Start of Green, Master Intersection	

Splits and Phases: 12: Unser Blvd & Paseo del Norte

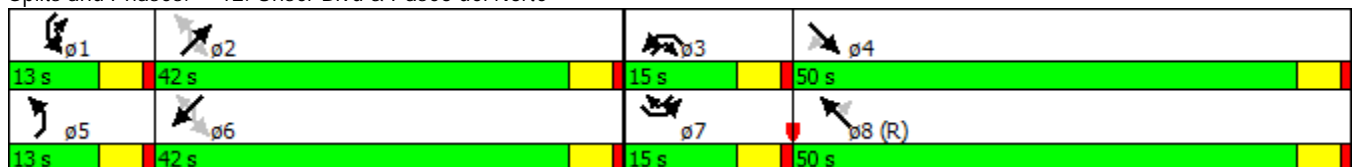

Timing Report, Sorted By Phase
 13: Kimmick Rd & Paseo del Norte

Scheme C -- Year 2035 PM
 6/1/2013



Phase Number	1	2	3	4	5	6	7	8
Movement	SBL	NBTL	WBL	EBT	NBL	SBTL	EBL	WBT
Lead/Lag	Lead	Lag	Lead	Lag	Lead	Lag	Lead	Lag
Lead-Lag Optimize	Yes	Yes			Yes	Yes	Yes	
Recall Mode	None	None	None	C-Min	None	None	None	C-Max
Maximum Split (s)	12	42	15	51	12	42	15	51
Maximum Split (%)	10.0%	35.0%	12.5%	42.5%	10.0%	35.0%	12.5%	42.5%
Minimum Split (s)	9	42	9.5	23	9	42	9.5	23
Yellow Time (s)	4	4	4	4	4	4	4	4
All-Red Time (s)	1	1	1	1	1	1	1	1
Minimum Initial (s)	4	4	4	4	4	4	4	4
Vehicle Extension (s)	3	3	3	3	3	3	3	3
Minimum Gap (s)	3	3	3	3	3	3	3	3
Time Before Reduce (s)	0	0	0	0	0	0	0	0
Time To Reduce (s)	0	0	0	0	0	0	0	0
Walk Time (s)		7		7		7		7
Flash Dont Walk (s)		30		11		30		11
Dual Entry	No	Yes	No	Yes	No	Yes	No	Yes
Inhibit Max	Yes	Yes	Yes	Yes	Yes	Yes	Yes	Yes
Start Time (s)	111	3	45	60	111	3	45	60
End Time (s)	3	45	60	111	3	45	60	111
Yield/Force Off (s)	118	40	55	106	118	40	55	106
Yield/Force Off 170(s)	118	10	55	95	118	10	55	95
Local Start Time (s)	51	63	105	0	51	63	105	0
Local Yield (s)	58	100	115	46	58	100	115	46
Local Yield 170(s)	58	70	115	35	58	70	115	35

Intersection Summary

Cycle Length	120
Control Type	Actuated-Coordinated
Natural Cycle	135
Offset: 60 (50%), Referenced to phase 4:EBT and 8:WBT, Start of Green	

Splits and Phases: 13: Kimmick Rd & Paseo del Norte

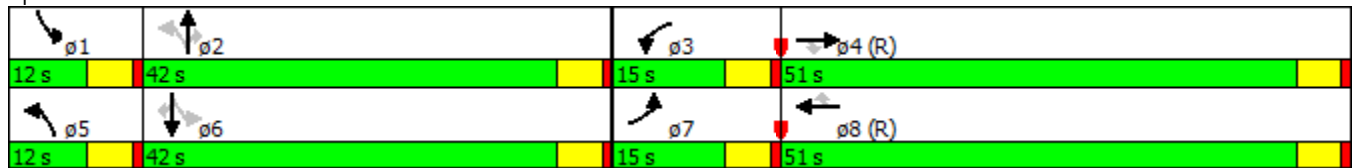

Timing Report, Sorted By Phase
 14: Transit Blvd & Unser Blvd



Phase Number	2	3	4	8
Movement	NBL	WBL	EBT	WBT
Lead/Lag		Lead	Lag	
Lead-Lag Optimize		Yes	Yes	
Recall Mode	Max	None	C-Max	None
Maximum Split (s)	42	23	55	55
Maximum Split (%)	35.0%	19.2%	45.8%	45.8%
Minimum Split (s)	37	9.5	23	23
Yellow Time (s)	4	4	4	4
All-Red Time (s)	1	1	1	1
Minimum Initial (s)	4	4	4	4
Vehicle Extension (s)	3	3	3	3
Minimum Gap (s)	3	3	3	3
Time Before Reduce (s)	0	0	0	0
Time To Reduce (s)	0	0	0	0
Walk Time (s)	7		7	7
Flash Dont Walk (s)	25		11	11
Dual Entry	Yes	No	Yes	Yes
Inhibit Max	Yes	Yes	Yes	Yes
Start Time (s)	55	97	0	97
End Time (s)	97	0	55	55
Yield/Force Off (s)	92	115	50	50
Yield/Force Off 170(s)	67	115	39	39
Local Start Time (s)	55	97	0	97
Local Yield (s)	92	115	50	50
Local Yield 170(s)	67	115	39	39

Intersection Summary

Cycle Length	120
Control Type	Actuated-Coordinated
Natural Cycle	75
Offset: 0 (0%), Referenced to phase 4:EBT, Start of Green	

Splits and Phases: 14: Transit Blvd & Unser Blvd

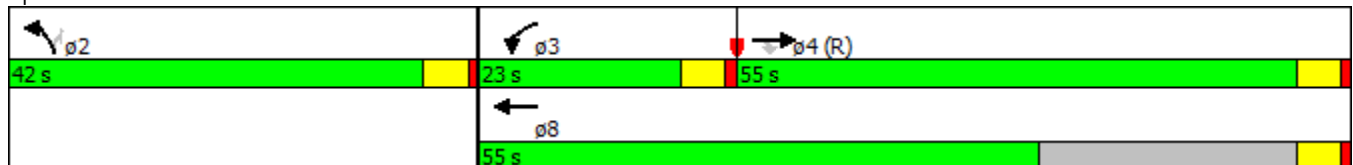

Timing Report, Sorted By Phase
 101: Paseo del Norte & Loop Rd W/Loop Rd N

Scheme C -- Year 2035 PM
 6/1/2013



Phase Number	2	3	4	6	7	8
Movement	EBTL	NWL	SET	WBTL	SEL	NWT
Lead/Lag		Lead	Lag		Lag	Lead
Lead-Lag Optimize		Yes	Yes		Yes	Yes
Recall Mode	None	None	Min	None	None	C-Max
Maximum Split (s)	42	16	62	42	16	62
Maximum Split (%)	35.0%	13.3%	51.7%	35.0%	13.3%	51.7%
Minimum Split (s)	27	9	27	42	9	42
Yellow Time (s)	4	4	4	4	4	4
All-Red Time (s)	1	1	1	1	1	1
Minimum Initial (s)	4	4	4	4	4	4
Vehicle Extension (s)	3	3	3	3	3	3
Minimum Gap (s)	3	3	3	3	3	3
Time Before Reduce (s)	0	0	0	0	0	0
Time To Reduce (s)	0	0	0	0	0	0
Walk Time (s)	7		7	7		7
Flash Dont Walk (s)	15		15	30		30
Dual Entry	Yes	No	Yes	Yes	No	Yes
Inhibit Max	Yes	Yes	Yes	Yes	Yes	Yes
Start Time (s)	98	20	36	98	82	20
End Time (s)	20	36	98	20	98	82
Yield/Force Off (s)	15	31	93	15	93	77
Yield/Force Off 170(s)	0	31	93	105	93	47
Local Start Time (s)	78	0	16	78	62	0
Local Yield (s)	115	11	73	115	73	57
Local Yield 170(s)	100	11	73	85	73	27

Intersection Summary

Cycle Length	120
Control Type	Actuated-Coordinated
Natural Cycle	105
Offset: 20 (17%), Referenced to phase 8:NWT, Start of Green	

Splits and Phases: 101: Paseo del Norte & Loop Rd W/Loop Rd N

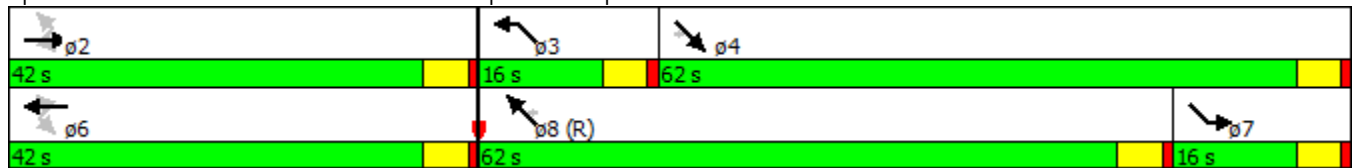

Timing Report, Sorted By Phase
 102: Unser Blvd & Loop Rd N



Phase Number	2	4	6	8
Movement	NWTL	NETL	SETL	SWTL
Lead/Lag				
Lead-Lag Optimize				
Recall Mode	None	C-Max	None	C-Max
Maximum Split (s)	42	78	42	78
Maximum Split (%)	35.0%	65.0%	35.0%	65.0%
Minimum Split (s)	23	23	23	23
Yellow Time (s)	4	4	4	4
All-Red Time (s)	1	1	1	1
Minimum Initial (s)	4	4	4	4
Vehicle Extension (s)	3	3	3	3
Minimum Gap (s)	3	3	3	3
Time Before Reduce (s)	0	0	0	0
Time To Reduce (s)	0	0	0	0
Walk Time (s)	7	7	7	7
Flash Dont Walk (s)	11	11	11	11
Dual Entry	Yes	Yes	Yes	Yes
Inhibit Max	Yes	Yes	Yes	Yes
Start Time (s)	18	60	18	60
End Time (s)	60	18	60	18
Yield/Force Off (s)	55	13	55	13
Yield/Force Off 170(s)	44	2	44	2
Local Start Time (s)	78	0	78	0
Local Yield (s)	115	73	115	73
Local Yield 170(s)	104	62	104	62

Intersection Summary

Cycle Length	120
Control Type	Actuated-Coordinated
Natural Cycle	50
Offset: 60 (50%), Referenced to phase 4:NETL and 8:SWTL, Start of Green	

Splits and Phases: 102: Unser Blvd & Loop Rd N

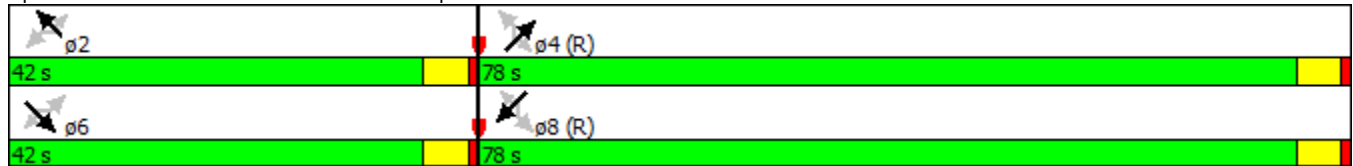

Timing Report, Sorted By Phase
 103: Avenita de Jaimito/Transit Blvd & Paseo del Norte

Scheme C -- Year 2035 PM
 6/1/2013



Phase Number	2	3	4	6	7	8
Movement	NETL	NWL	SET	SWTL	SEL	NWT
Lead/Lag		Lead	Lag		Lag	Lead
Lead-Lag Optimize		Yes	Yes			
Recall Mode	None	None	Max	None	None	C-Max
Maximum Split (s)	42	18	60	42	18	60
Maximum Split (%)	35.0%	15.0%	50.0%	35.0%	15.0%	50.0%
Minimum Split (s)	42	9	27	42	9	27
Yellow Time (s)	4	4	4	4	4	4
All-Red Time (s)	1	1	1	1	1	1
Minimum Initial (s)	4	4	4	4	4	4
Vehicle Extension (s)	3	3	3	3	3	3
Minimum Gap (s)	3	3	3	3	3	3
Time Before Reduce (s)	0	0	0	0	0	0
Time To Reduce (s)	0	0	0	0	0	0
Walk Time (s)	7		7	7		7
Flash Dont Walk (s)	30		15	30		15
Dual Entry	Yes	No	Yes	Yes	No	Yes
Inhibit Max	Yes	Yes	Yes	Yes	Yes	Yes
Start Time (s)	98	20	38	98	80	20
End Time (s)	20	38	98	20	98	80
Yield/Force Off (s)	15	33	93	15	93	75
Yield/Force Off 170(s)	105	33	78	105	93	60
Local Start Time (s)	78	0	18	78	60	0
Local Yield (s)	115	13	73	115	73	55
Local Yield 170(s)	85	13	58	85	73	40

Intersection Summary

Cycle Length	120
Control Type	Actuated-Coordinated
Natural Cycle	110
Offset: 20 (17%), Referenced to phase 8:NWT, Start of Green	

Splits and Phases: 103: Avenita de Jaimito/Transit Blvd & Paseo del Norte

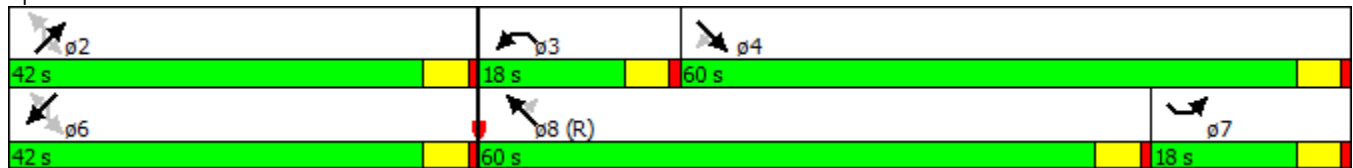

Timing Report, Sorted By Phase
 104: Unser Blvd & Loop Rd W/Avenida de Jaimito

Scheme C -- Year 2035 PM
 6/1/2013



Phase Number	2	4	6	8
Movement	NBTL	EBTL	SBTL	WBTL
Lead/Lag				
Lead-Lag Optimize				
Recall Mode	None	C-Max	None	C-Max
Maximum Split (s)	82	38	82	38
Maximum Split (%)	68.3%	31.7%	68.3%	31.7%
Minimum Split (s)	23	23	23	23
Yellow Time (s)	4	4	4	4
All-Red Time (s)	1	1	1	1
Minimum Initial (s)	4	4	4	4
Vehicle Extension (s)	3	3	3	3
Minimum Gap (s)	3	3	3	3
Time Before Reduce (s)	0	0	0	0
Time To Reduce (s)	0	0	0	0
Walk Time (s)	7	7	7	7
Flash Dont Walk (s)	11	11	11	11
Dual Entry	Yes	Yes	Yes	Yes
Inhibit Max	Yes	Yes	Yes	Yes
Start Time (s)	38	0	38	0
End Time (s)	0	38	0	38
Yield/Force Off (s)	115	33	115	33
Yield/Force Off 170(s)	104	22	104	22
Local Start Time (s)	38	0	38	0
Local Yield (s)	115	33	115	33
Local Yield 170(s)	104	22	104	22

Intersection Summary

Cycle Length	120
Control Type	Actuated-Coordinated
Natural Cycle	50
Offset: 0 (0%), Referenced to phase 4:EBTL and 8:WBTL, Start of Green	

Splits and Phases: 104: Unser Blvd & Loop Rd W/Avenida de Jaimito



Timing Report, Sorted By Phase
 11: Universe & Paseo del Norte

Scheme D -- Year 2035 PM
 6/6/2013



Phase Number	1	2	3	4	5	6	7	8
Movement	SBL	NBT	WBL	EBT	NBL	SBT	EBL	WBT
Lead/Lag	Lead	Lag	Lead	Lag	Lead	Lag	Lag	Lead
Lead-Lag Optimize	Yes	Yes	Yes	Yes	Yes	Yes	Yes	Yes
Recall Mode	None	None	None	None	None	None	None	C-Max
Maximum Split (s)	11.5	42	11.5	55	11.5	42	11.5	55
Maximum Split (%)	9.6%	35.0%	9.6%	45.8%	9.6%	35.0%	9.6%	45.8%
Minimum Split (s)	9	42	9	35	9	42	9	35
Yellow Time (s)	3.5	4	3.5	4	3.5	4	3.5	4
All-Red Time (s)	1	1	1	1	1	1	1	1
Minimum Initial (s)	4	4	4	4	4	4	4	4
Vehicle Extension (s)	3	3	3	3	3	3	3	3
Minimum Gap (s)	3	3	3	3	3	3	3	3
Time Before Reduce (s)	0	0	0	0	0	0	0	0
Time To Reduce (s)	0	0	0	0	0	0	0	0
Walk Time (s)		7		7		7		7
Flash Dont Walk (s)		30		23		30		23
Dual Entry	No	Yes	No	Yes	No	Yes	No	Yes
Inhibit Max	Yes	Yes	Yes	Yes	Yes	Yes	Yes	Yes
Start Time (s)	6.5	18	60	71.5	6.5	18	115	60
End Time (s)	18	60	71.5	6.5	18	60	6.5	115
Yield/Force Off (s)	13.5	55	67	1.5	13.5	55	2	110
Yield/Force Off 170(s)	13.5	25	67	98.5	13.5	25	2	87
Local Start Time (s)	66.5	78	0	11.5	66.5	78	55	0
Local Yield (s)	73.5	115	7	61.5	73.5	115	62	50
Local Yield 170(s)	73.5	85	7	38.5	73.5	85	62	27

Intersection Summary

Cycle Length	120
Control Type	Actuated-Coordinated
Natural Cycle	115
Offset: 60 (50%), Referenced to phase 8:WBT, Start of Green	

Splits and Phases: 11: Universe & Paseo del Norte

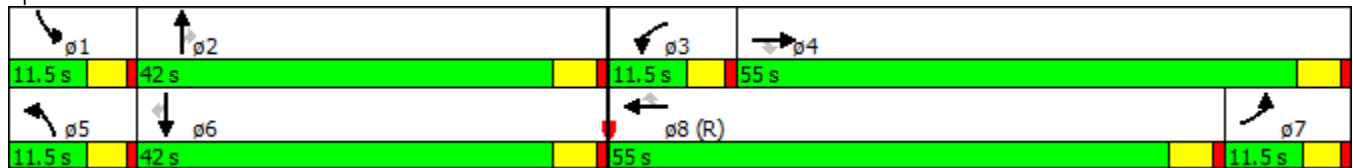

Timing Report, Sorted By Phase
12: Unser Blvd & Paseo del Norte

Scheme D -- Year 2035 PM

6/6/2013

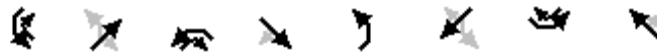

Phase Number	1	2	3	4	5	6	7	8
Movement	SWL	NETL	NWL	SET	NEL	SWTL	SEL	NWT
Lead/Lag	Lead	Lag	Lead	Lag	Lead	Lag	Lead	Lag
Lead-Lag Optimize	Yes	Yes	Yes	Yes	Yes	Yes	Yes	Yes
Recall Mode	None	None	None	Max	None	None	None	C-Max
Maximum Split (s)	13	42	15	50	13	42	15	50
Maximum Split (%)	10.8%	35.0%	12.5%	41.7%	10.8%	35.0%	12.5%	41.7%
Minimum Split (s)	9	42	9	41	9	42	9	41
Yellow Time (s)	4	4	4	4	4	4	4	4
All-Red Time (s)	1	1	1	1	1	1	1	1
Minimum Initial (s)	4	4	4	4	4	4	4	4
Vehicle Extension (s)	3	3	3	3	3	3	3	3
Minimum Gap (s)	3	3	3	3	3	3	3	3
Time Before Reduce (s)	0	0	0	0	0	0	0	0
Time To Reduce (s)	0	0	0	0	0	0	0	0
Walk Time (s)		7		7		7		7
Flash Dont Walk (s)		30		29		30		29
Dual Entry	No	Yes	No	Yes	No	Yes	No	Yes
Inhibit Max	Yes	Yes	Yes	Yes	Yes	Yes	Yes	Yes
Start Time (s)	50	63	105	0	50	63	105	0
End Time (s)	63	105	0	50	63	105	0	50
Yield/Force Off (s)	58	100	115	45	58	100	115	45
Yield/Force Off 170(s)	58	70	115	16	58	70	115	16
Local Start Time (s)	50	63	105	0	50	63	105	0
Local Yield (s)	58	100	115	45	58	100	115	45
Local Yield 170(s)	58	70	115	16	58	70	115	16

Intersection Summary

Cycle Length	120
Control Type	Actuated-Coordinated
Natural Cycle	125
Offset: 0 (0%), Referenced to phase 8:NWT, Start of Green, Master Intersection	

Splits and Phases: 12: Unser Blvd & Paseo del Norte

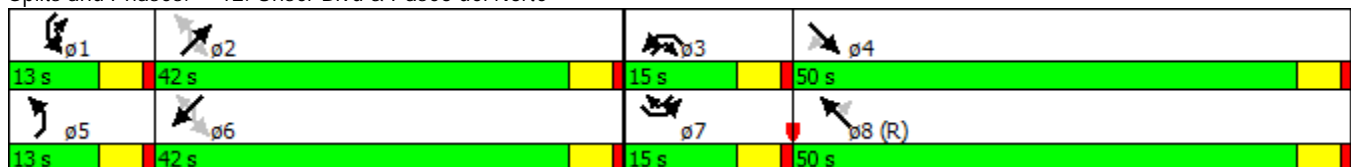

Timing Report, Sorted By Phase
 13: Kimmick Rd & Paseo del Norte

Scheme D -- Year 2035 PM

6/6/2013

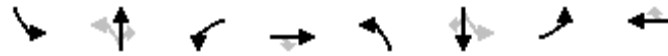

Phase Number	1	2	3	4	5	6	7	8
Movement	SBL	NBTL	WBL	EBT	NBL	SBTL	EBL	WBT
Lead/Lag	Lead	Lag	Lead	Lag	Lead	Lag	Lead	Lag
Lead-Lag Optimize	Yes	Yes			Yes	Yes	Yes	
Recall Mode	None	None	None	C-Min	None	None	None	C-Max
Maximum Split (s)	10	42	17	51	10	42	17	51
Maximum Split (%)	8.3%	35.0%	14.2%	42.5%	8.3%	35.0%	14.2%	42.5%
Minimum Split (s)	9	42	9.5	23	9	42	9.5	23
Yellow Time (s)	4	4	4	4	4	4	4	4
All-Red Time (s)	1	1	1	1	1	1	1	1
Minimum Initial (s)	4	4	4	4	4	4	4	4
Vehicle Extension (s)	3	3	3	3	3	3	3	3
Minimum Gap (s)	3	3	3	3	3	3	3	3
Time Before Reduce (s)	0	0	0	0	0	0	0	0
Time To Reduce (s)	0	0	0	0	0	0	0	0
Walk Time (s)		7		7		7		7
Flash Dont Walk (s)		30		11		30		11
Dual Entry	No	Yes	No	Yes	No	Yes	No	Yes
Inhibit Max	Yes	Yes	Yes	Yes	Yes	Yes	Yes	Yes
Start Time (s)	111	1	43	60	111	1	43	60
End Time (s)	1	43	60	111	1	43	60	111
Yield/Force Off (s)	116	38	55	106	116	38	55	106
Yield/Force Off 170(s)	116	8	55	95	116	8	55	95
Local Start Time (s)	51	61	103	0	51	61	103	0
Local Yield (s)	56	98	115	46	56	98	115	46
Local Yield 170(s)	56	68	115	35	56	68	115	35

Intersection Summary

Cycle Length	120
Control Type	Actuated-Coordinated
Natural Cycle	135
Offset: 60 (50%), Referenced to phase 4:EBT and 8:WBT, Start of Green	

Splits and Phases: 13: Kimmick Rd & Paseo del Norte

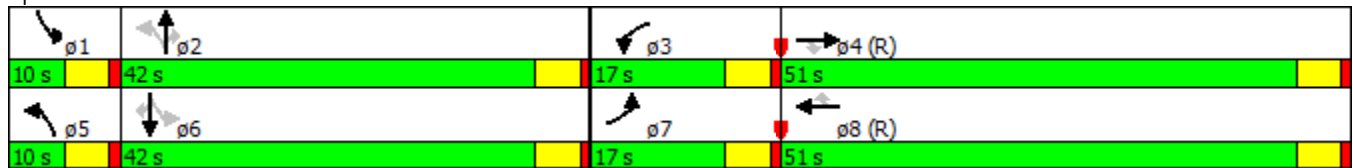

Timing Report, Sorted By Phase
 14: Transit Blvd & Unser Blvd

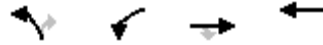

Phase Number	2	3	4	8
Movement	NBL	WBL	EBT	WBT
Lead/Lag		Lead	Lag	
Lead-Lag Optimize		Yes	Yes	
Recall Mode	Max	None	C-Max	None
Maximum Split (s)	42	23	55	55
Maximum Split (%)	35.0%	19.2%	45.8%	45.8%
Minimum Split (s)	37	9.5	23	23
Yellow Time (s)	4	4	4	4
All-Red Time (s)	1	1	1	1
Minimum Initial (s)	4	4	4	4
Vehicle Extension (s)	3	3	3	3
Minimum Gap (s)	3	3	3	3
Time Before Reduce (s)	0	0	0	0
Time To Reduce (s)	0	0	0	0
Walk Time (s)	7		7	7
Flash Dont Walk (s)	25		11	11
Dual Entry	Yes	No	Yes	Yes
Inhibit Max	Yes	Yes	Yes	Yes
Start Time (s)	55	97	0	97
End Time (s)	97	0	55	55
Yield/Force Off (s)	92	115	50	50
Yield/Force Off 170(s)	67	115	39	39
Local Start Time (s)	55	97	0	97
Local Yield (s)	92	115	50	50
Local Yield 170(s)	67	115	39	39

Intersection Summary

Cycle Length	120
Control Type	Actuated-Coordinated
Natural Cycle	75
Offset: 0 (0%), Referenced to phase 4:EBT, Start of Green	

Splits and Phases: 14: Transit Blvd & Unser Blvd

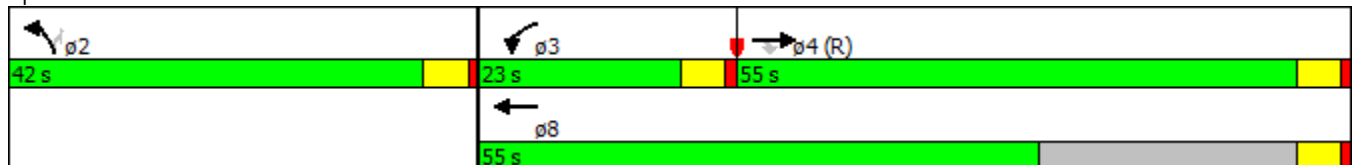

Timing Report, Sorted By Phase
 101: Paseo del Norte & Loop Rd W

Scheme D -- Year 2035 PM
 6/6/2013



Phase Number	2	3	4	6	7	8
Movement	EBTL	NWL	SET	WBTL	SEL	NWT
Lead/Lag		Lead	Lag		Lag	Lead
Lead-Lag Optimize		Yes	Yes		Yes	Yes
Recall Mode	None	None	Min	None	None	C-Max
Maximum Split (s)	42	16	62	42	16	62
Maximum Split (%)	35.0%	13.3%	51.7%	35.0%	13.3%	51.7%
Minimum Split (s)	27	9	27	42	9	42
Yellow Time (s)	4	4	4	4	4	4
All-Red Time (s)	1	1	1	1	1	1
Minimum Initial (s)	4	4	4	4	4	4
Vehicle Extension (s)	3	3	3	3	3	3
Minimum Gap (s)	3	3	3	3	3	3
Time Before Reduce (s)	0	0	0	0	0	0
Time To Reduce (s)	0	0	0	0	0	0
Walk Time (s)	7		7	7		7
Flash Dont Walk (s)	15		15	30		30
Dual Entry	Yes	No	Yes	Yes	No	Yes
Inhibit Max	Yes	Yes	Yes	Yes	Yes	Yes
Start Time (s)	98	20	36	98	82	20
End Time (s)	20	36	98	20	98	82
Yield/Force Off (s)	15	31	93	15	93	77
Yield/Force Off 170(s)	0	31	93	105	93	47
Local Start Time (s)	78	0	16	78	62	0
Local Yield (s)	115	11	73	115	73	57
Local Yield 170(s)	100	11	73	85	73	27

Intersection Summary

Cycle Length	120
Control Type	Actuated-Coordinated
Natural Cycle	105
Offset: 20 (17%), Referenced to phase 8:NWT, Start of Green	

Splits and Phases: 101: Paseo del Norte & Loop Rd W

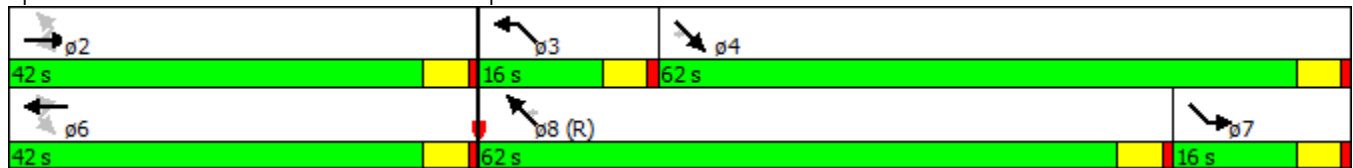

Timing Report, Sorted By Phase
102: Unser Blvd & Loop Rd N

Scheme D -- Year 2035 PM

6/6/2013



Phase Number	2	4	6	8
Movement	NWTL	NETL	SETL	SWTL
Lead/Lag				
Lead-Lag Optimize				
Recall Mode	None	C-Max	None	C-Max
Maximum Split (s)	42	78	42	78
Maximum Split (%)	35.0%	65.0%	35.0%	65.0%
Minimum Split (s)	23	23	23	23
Yellow Time (s)	4	4	4	4
All-Red Time (s)	1	1	1	1
Minimum Initial (s)	4	4	4	4
Vehicle Extension (s)	3	3	3	3
Minimum Gap (s)	3	3	3	3
Time Before Reduce (s)	0	0	0	0
Time To Reduce (s)	0	0	0	0
Walk Time (s)	7	7	7	7
Flash Dont Walk (s)	11	11	11	11
Dual Entry	Yes	Yes	Yes	Yes
Inhibit Max	Yes	Yes	Yes	Yes
Start Time (s)	18	60	18	60
End Time (s)	60	18	60	18
Yield/Force Off (s)	55	13	55	13
Yield/Force Off 170(s)	44	2	44	2
Local Start Time (s)	78	0	78	0
Local Yield (s)	115	73	115	73
Local Yield 170(s)	104	62	104	62

Intersection Summary

Cycle Length	120
Control Type	Actuated-Coordinated
Natural Cycle	50
Offset: 60 (50%), Referenced to phase 4:NETL and 8:SWTL, Start of Green	

Splits and Phases: 102: Unser Blvd & Loop Rd N

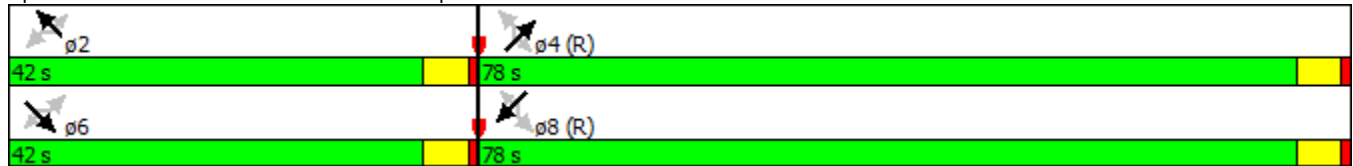

Timing Report, Sorted By Phase
 103: Loop Rd E/Loop Rd East & Paseo del Norte

Scheme D -- Year 2035 PM
 6/6/2013



Phase Number	2	3	4	6	7	8
Movement	NETL	NWL	SET	SWTL	SEL	NWT
Lead/Lag		Lead	Lag		Lag	Lead
Lead-Lag Optimize		Yes	Yes			
Recall Mode	None	None	Max	None	None	C-Max
Maximum Split (s)	42	18	60	42	18	60
Maximum Split (%)	35.0%	15.0%	50.0%	35.0%	15.0%	50.0%
Minimum Split (s)	42	9	27	42	9	27
Yellow Time (s)	4	4	4	4	4	4
All-Red Time (s)	1	1	1	1	1	1
Minimum Initial (s)	4	4	4	4	4	4
Vehicle Extension (s)	3	3	3	3	3	3
Minimum Gap (s)	3	3	3	3	3	3
Time Before Reduce (s)	0	0	0	0	0	0
Time To Reduce (s)	0	0	0	0	0	0
Walk Time (s)	7		7	7		7
Flash Dont Walk (s)	30		15	30		15
Dual Entry	Yes	No	Yes	Yes	No	Yes
Inhibit Max	Yes	Yes	Yes	Yes	Yes	Yes
Start Time (s)	88	10	28	88	70	10
End Time (s)	10	28	88	10	88	70
Yield/Force Off (s)	5	23	83	5	83	65
Yield/Force Off 170(s)	95	23	68	95	83	50
Local Start Time (s)	78	0	18	78	60	0
Local Yield (s)	115	13	73	115	73	55
Local Yield 170(s)	85	13	58	85	73	40

Intersection Summary

Cycle Length	120
Control Type	Actuated-Coordinated
Natural Cycle	110
Offset: 10 (8%), Referenced to phase 8:NWT, Start of Green	

Splits and Phases: 103: Loop Rd E/Loop Rd East & Paseo del Norte

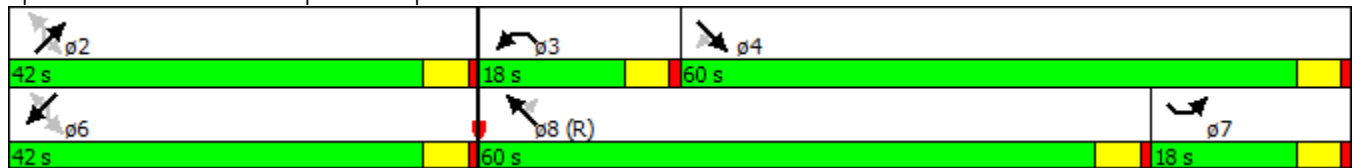

Timing Report, Sorted By Phase
104: Unser Blvd & Loop Rd S



Phase Number	2	4	6	8
Movement	NBTL	EBTL	SBTL	WBTL
Lead/Lag				
Lead-Lag Optimize				
Recall Mode	None	C-Max	None	C-Max
Maximum Split (s)	82	38	82	38
Maximum Split (%)	68.3%	31.7%	68.3%	31.7%
Minimum Split (s)	23	23	23	23
Yellow Time (s)	4	4	4	4
All-Red Time (s)	1	1	1	1
Minimum Initial (s)	4	4	4	4
Vehicle Extension (s)	3	3	3	3
Minimum Gap (s)	3	3	3	3
Time Before Reduce (s)	0	0	0	0
Time To Reduce (s)	0	0	0	0
Walk Time (s)	7	7	7	7
Flash Dont Walk (s)	11	11	11	11
Dual Entry	Yes	Yes	Yes	Yes
Inhibit Max	Yes	Yes	Yes	Yes
Start Time (s)	38	0	38	0
End Time (s)	0	38	0	38
Yield/Force Off (s)	115	33	115	33
Yield/Force Off 170(s)	104	22	104	22
Local Start Time (s)	38	0	38	0
Local Yield (s)	115	33	115	33
Local Yield 170(s)	104	22	104	22

Intersection Summary

Cycle Length	120
Control Type	Actuated-Coordinated
Natural Cycle	50
Offset: 0 (0%), Referenced to phase 4:EBTL and 8:WBTL, Start of Green	

Splits and Phases: 104: Unser Blvd & Loop Rd S





Phase Number	4	6	8
Movement	EBTL	SBL	WBT
Lead/Lag			
Lead-Lag Optimize			
Recall Mode	None	None	C-Max
Maximum Split (s)	78	42	78
Maximum Split (%)	65.0%	35.0%	65.0%
Minimum Split (s)	23	23	23
Yellow Time (s)	4	4	4
All-Red Time (s)	1	1	1
Minimum Initial (s)	4	4	4
Vehicle Extension (s)	3	3	3
Minimum Gap (s)	3	3	3
Time Before Reduce (s)	0	0	0
Time To Reduce (s)	0	0	0
Walk Time (s)	7	7	7
Flash Dont Walk (s)	11	11	11
Dual Entry	Yes	Yes	Yes
Inhibit Max	Yes	Yes	Yes
Start Time (s)	30	108	30
End Time (s)	108	30	108
Yield/Force Off (s)	103	25	103
Yield/Force Off 170(s)	92	14	92
Local Start Time (s)	0	78	0
Local Yield (s)	73	115	73
Local Yield 170(s)	62	104	62

Intersection Summary

Cycle Length	120
Control Type	Actuated-Coordinated
Natural Cycle	60
Offset: 30 (25%), Referenced to phase 8:WBT, Start of Green	

Splits and Phases: 105: Paseo del Norte & Transit Blvd

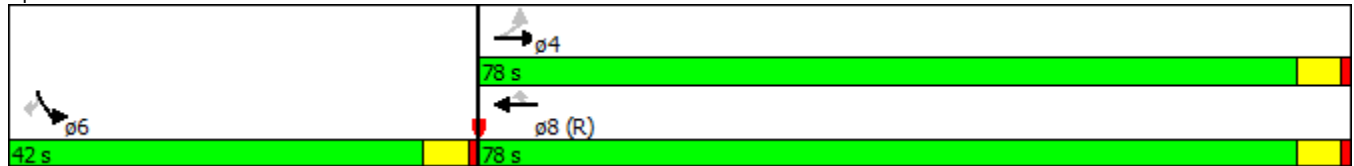

Appendix C

Arterial Level of Service

Arterial Level of Service: NW Paseo del Norte

Cross Street	Arterial Class	Flow Speed	Running Time	Signal Delay	Travel Time (s)	Dist (mi)	Arterial Speed	Arterial LOS
	II	45	11.0	2.9	13.9	0.10	26.2	C
Kimmick Rd	II	45	51.7	29.9	81.6	0.65	28.5	B
Loop Rd East	II	45	50.4	30.2	80.6	0.63	28.1	B
Unser Blvd	II	45	24.4	136.7	161.1	0.22	5.0	F
Loop Rd N	II	45	27.8	5.7	33.5	0.28	30.1	B
Universe	II	45	29.0	13.5	42.5	0.29	24.8	C
Total	II		194.3	218.9	413.2	2.17	18.9	D

Arterial Level of Service: EB Paseo del Norte

Cross Street	Arterial Class	Flow Speed	Running Time	Signal Delay	Travel Time (s)	Dist (mi)	Arterial Speed	Arterial LOS
Universe	II	45	44.6	26.0	70.6	0.51	25.9	C
Loop Rd W	II	45	29.0	46.0	75.0	0.29	14.0	E
Unser Blvd	II	45	27.8	65.2	93.0	0.28	10.9	F
Avenida de Jaimito	II	45	24.4	11.6	36.0	0.22	22.4	C
Kimmick Rd	II	45	50.4	21.7	72.1	0.63	31.4	B
	II	45	51.7	1.2	52.9	0.65	44.0	A
Total	II		227.9	171.7	399.6	2.58	23.2	C

Arterial Level of Service: NB Unser Blvd

Cross Street	Arterial Class	Flow Speed	Running Time	Signal Delay	Travel Time (s)	Dist (mi)	Arterial Speed	Arterial LOS
Rose Parks	II	45	3.8	24.9	28.7	0.03	4.4	F
Avenida de Jaimito	II	45	44.6	28.6	73.2	0.51	24.9	C
Paseo del Norte	II	45	24.3	30.6	54.9	0.22	14.6	E
Loop Rd N	II	45	24.4	1.2	25.6	0.22	31.5	B
Transit Blvd	II	40	26.7	15.6	42.3	0.24	20.6	D
Total	II		123.8	100.9	224.7	1.23	19.7	D

Arterial Level of Service: SB Unser Blvd

Cross Street	Arterial Class	Flow Speed	Running Time	Signal Delay	Travel Time (s)	Dist (mi)	Arterial Speed	Arterial LOS
Transit Blvd	II	45	10.3	12.6	22.9	0.09	14.9	E
Loop Rd N	II	44	25.2	5.1	30.3	0.24	28.8	B
Paseo del Norte	II	45	24.4	39.5	63.9	0.22	12.6	F
Loop Rd W	II	45	24.3	39.8	64.1	0.22	12.5	F
Rose Parks	II	45	44.6	20.0	64.6	0.51	28.3	B
Total	II		128.8	117.0	245.8	1.29	18.9	D

Arterial Level of Service: EB Paseo del Norte

Cross Street	Arterial Class	Flow Speed	Running Time	Signal Delay	Travel Time (s)	Dist (mi)	Arterial Speed	Arterial LOS
Universe	II	45	44.6	26.0	70.6	0.51	25.9	C
Unser Blvd	II	45	45.8	53.8	99.6	0.57	20.7	D
Kimmick Rd	II	45	43.0	24.0	67.0	0.49	26.2	C
	II	45	59.2	0.8	60.0	0.74	44.5	A
Total	II		192.6	104.6	297.2	2.31	28.0	C

Arterial Level of Service: WB Paseo del Norte

Cross Street	Arterial Class	Flow Speed	Running Time	Signal Delay	Travel Time (s)	Dist (mi)	Arterial Speed	Arterial LOS
	II	45	11.0	2.9	13.9	0.10	26.2	C
Kimmick Rd	II	45	59.2	114.2	173.4	0.74	15.4	E
Unser Blvd	II	45	28.2	150.8	179.0	0.28	5.7	F
Universe	II	45	45.8	10.7	56.5	0.57	36.5	A
Total	II		144.2	278.6	422.8	1.70	14.5	E

Arterial Level of Service: EB Unser Blvd

Cross Street	Arterial Class	Flow Speed	Running Time	Signal Delay	Travel Time (s)	Dist (mi)	Arterial Speed	Arterial LOS
Rose Parks	II	45	3.8	24.9	28.7	0.03	4.4	F
Paseo del Norte	II	45	31.9	49.8	81.7	0.32	14.2	E
Transit Blvd	II	43	39.8	15.2	55.0	0.44	28.6	B
Total	II		75.5	89.9	165.4	0.79	17.3	D

Arterial Level of Service: WB Unser Blvd

Cross Street	Arterial Class	Flow Speed	Running Time	Signal Delay	Travel Time (s)	Dist (mi)	Arterial Speed	Arterial LOS
Transit Blvd	II	45	42.9	25.4	68.3	0.47	24.9	C
Paseo del Norte	II	45	39.8	40.6	80.4	0.44	19.6	D
Rose Parks	II	45	36.5	20.0	56.5	0.39	24.8	C
Total	II		119.2	86.0	205.2	1.30	22.8	C

Arterial Level of Service: NW Paseo del Norte

Cross Street	Arterial Class	Flow Speed	Running Time	Signal Delay	Travel Time (s)	Dist (mi)	Arterial Speed	Arterial LOS
Transit Blvd	II	45	43.8	44.6	88.4	0.50	20.3	D
Unser Blvd	II	45	28.5	144.4	172.9	0.27	5.7	F
Loop Rd N	II	45	27.8	5.4	33.2	0.28	30.4	B
Universe	II	45	29.0	13.4	42.4	0.29	24.8	C
Total	II		129.1	207.8	336.9	1.35	14.4	E

Arterial Level of Service: SE Paseo del Norte

Cross Street	Arterial Class	Flow Speed	Running Time	Signal Delay	Travel Time (s)	Dist (mi)	Arterial Speed	Arterial LOS
Universe	II	45	44.6	26.0	70.6	0.51	25.9	C
Loop Rd W	II	45	29.0	46.0	75.0	0.29	14.0	E
Unser Blvd	II	45	27.8	65.2	93.0	0.28	10.9	F
Avenida de Jaimito	II	45	28.5	14.9	43.4	0.27	22.8	C
Total	II		129.9	152.1	282.0	1.35	17.3	D

Arterial Level of Service: NE Unser Blvd

Cross Street	Arterial Class	Flow Speed	Running Time	Signal Delay	Travel Time (s)	Dist (mi)	Arterial Speed	Arterial LOS
Avenida de Jaimito	II	45	36.5	28.6	65.1	0.39	21.5	D
Paseo del Norte	II	45	31.9	30.4	62.3	0.32	18.6	D
Loop Rd N	II	45	25.9	1.4	27.3	0.25	32.8	B
Total	II		94.3	60.4	154.7	0.96	22.3	C

Arterial Level of Service: SW Unser Blvd

Cross Street	Arterial Class	Flow Speed	Running Time	Signal Delay	Travel Time (s)	Dist (mi)	Arterial Speed	Arterial LOS
Loop Rd N	II	44	26.4	5.3	31.7	0.25	28.8	B
Paseo del Norte	II	45	25.9	39.9	65.8	0.25	13.6	E
Loop Rd W	II	45	31.9	48.4	80.3	0.32	14.4	E
Total	II		84.2	93.6	177.8	0.82	16.7	E

Arterial Level of Service: EB Paseo del Norte

Cross Street	Arterial Class	Flow Speed	Running Time	Signal Delay	Travel Time (s)	Dist (mi)	Arterial Speed	Arterial LOS
Universe	II	45	44.6	26.0	70.6	0.51	25.9	C
Loop Rd W	II	45	29.0	46.0	75.0	0.29	14.0	E
Unser Blvd	II	45	27.8	65.2	93.0	0.28	10.9	F
Loop Rd E	II	45	24.4	10.3	34.7	0.22	23.2	C
Transit Blvd	II	45	28.3	3.0	31.3	0.29	32.9	B
Kimmick Rd	II	45	33.0	19.5	52.5	0.34	23.5	C
	II	45	51.7	1.4	53.1	0.65	43.8	A
Total	II		238.8	171.4	410.2	2.58	22.6	C

Arterial Level of Service: WB Paseo del Norte

Cross Street	Arterial Class	Flow Speed	Running Time	Signal Delay	Travel Time (s)	Dist (mi)	Arterial Speed	Arterial LOS
	II	45	11.0	2.9	13.9	0.10	26.2	C
Kimmick Rd	II	45	51.7	28.1	79.8	0.65	29.2	B
Transit Blvd	II	45	33.0	15.9	48.9	0.34	25.3	C
Loop Rd East	II	45	28.3	26.0	54.3	0.29	18.9	D
Unser Blvd	II	45	24.4	135.8	160.2	0.22	5.0	F
Loop Rd W	II	45	27.8	5.7	33.5	0.28	30.1	B
Universe	II	45	29.0	13.6	42.6	0.29	24.7	C
Total	II		205.2	228.0	433.2	2.17	18.1	D

Arterial Level of Service: NB Unser Blvd

Cross Street	Arterial Class	Flow Speed	Running Time	Signal Delay	Travel Time (s)	Dist (mi)	Arterial Speed	Arterial LOS
Rose Parks	II	45	3.8	24.9	28.7	0.03	4.4	F
Loop Rd S	II	45	44.6	28.6	73.2	0.51	24.9	C
Paseo del Norte	II	45	24.3	30.5	54.8	0.22	14.6	E
Loop Rd N	II	45	24.4	1.2	25.6	0.22	31.5	B
Transit Blvd	II	40	26.7	15.9	42.6	0.24	20.5	D
Total	II		123.8	101.1	224.9	1.23	19.7	D

Arterial Level of Service: SB Unser Blvd

Cross Street	Arterial Class	Flow Speed	Running Time	Signal Delay	Travel Time (s)	Dist (mi)	Arterial Speed	Arterial LOS
Transit Blvd	II	45	10.3	12.6	22.9	0.09	14.9	E
Loop Rd N	II	44	25.2	5.1	30.3	0.24	28.8	B
Paseo del Norte	II	45	24.4	39.6	64.0	0.22	12.6	F
Loop Rd S	II	45	24.3	39.8	64.1	0.22	12.5	F
Rose Parks	II	45	44.6	20.0	64.6	0.51	28.3	B
Total	II		128.8	117.1	245.9	1.29	18.9	D

Appendix D

Turning Movements (Scheme A)

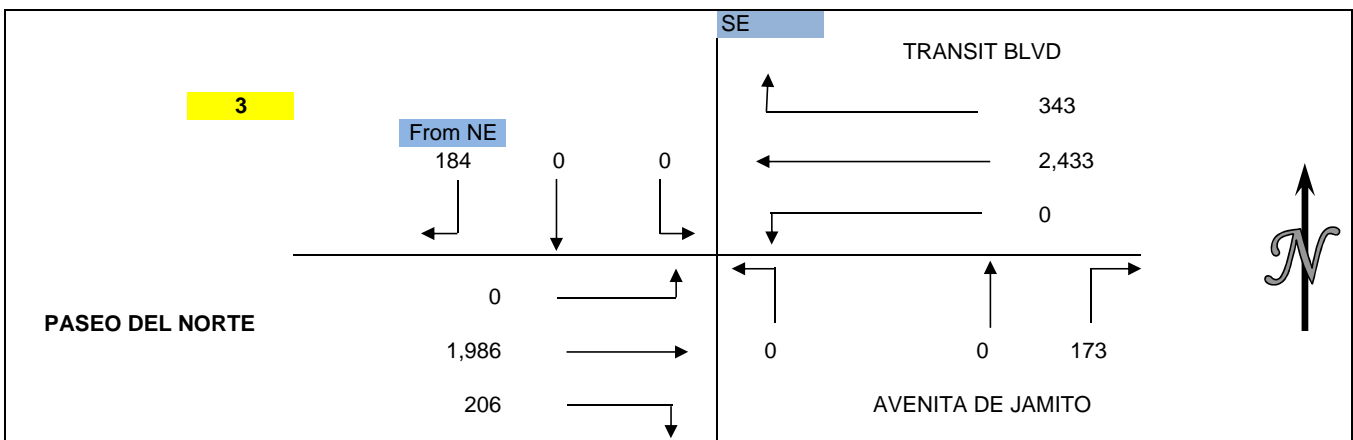
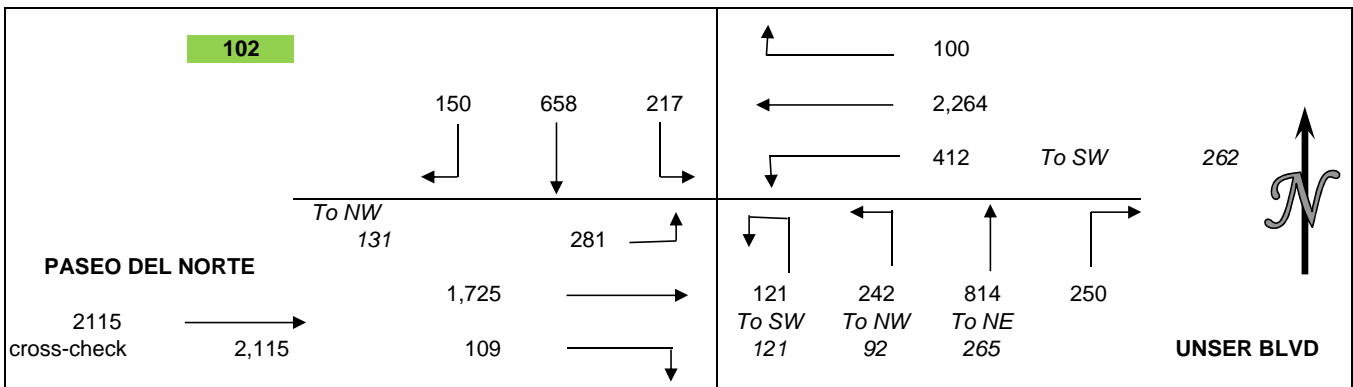
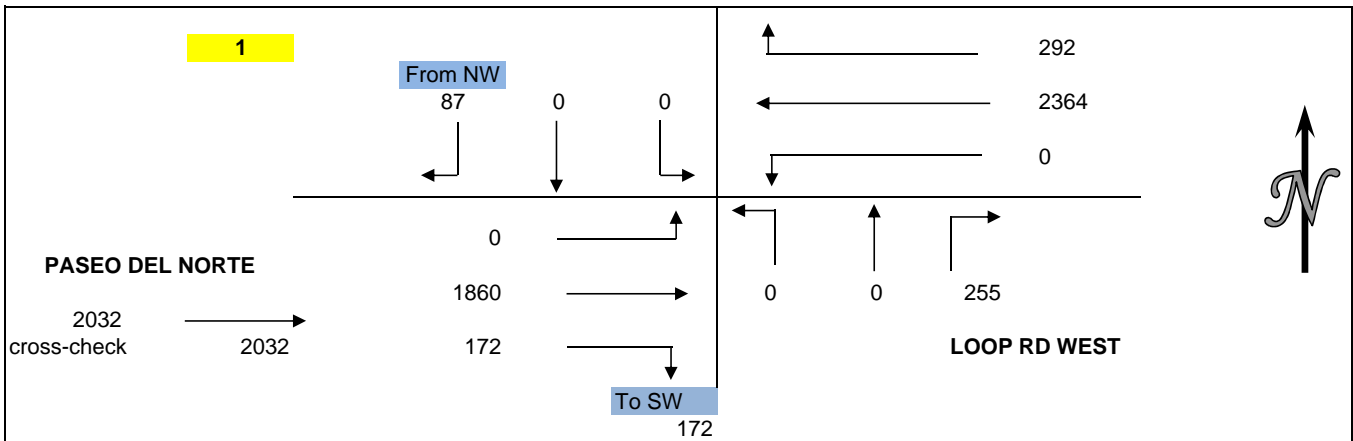
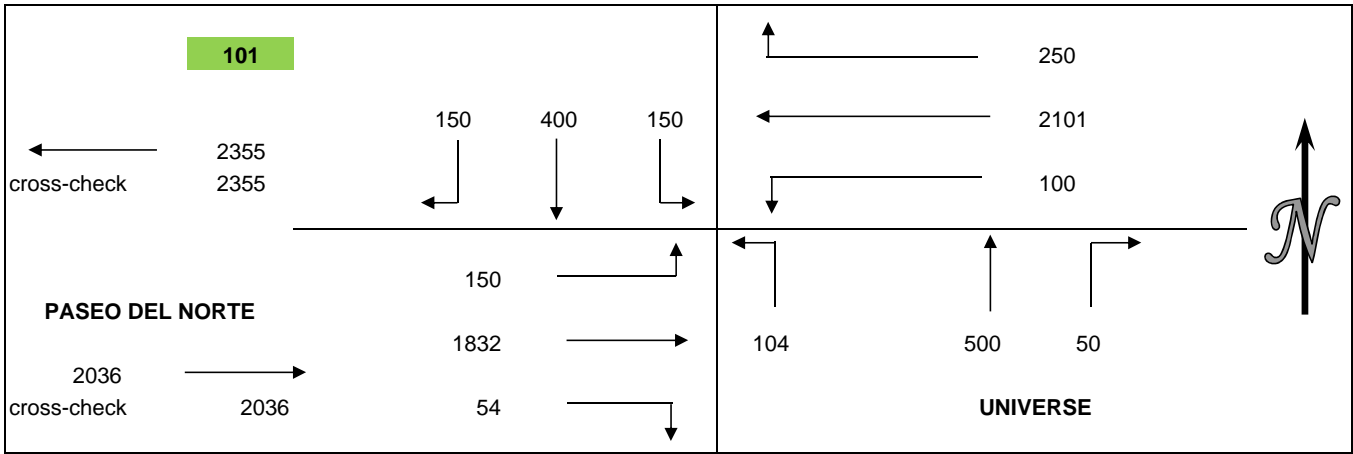

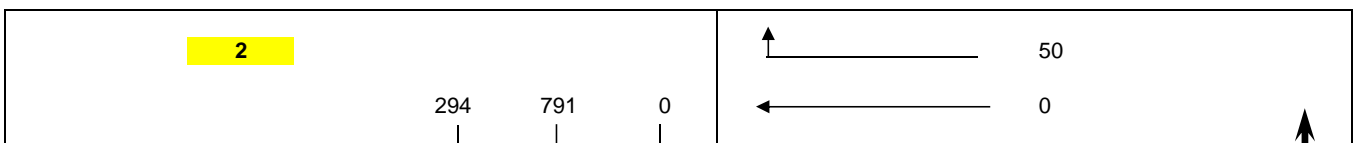
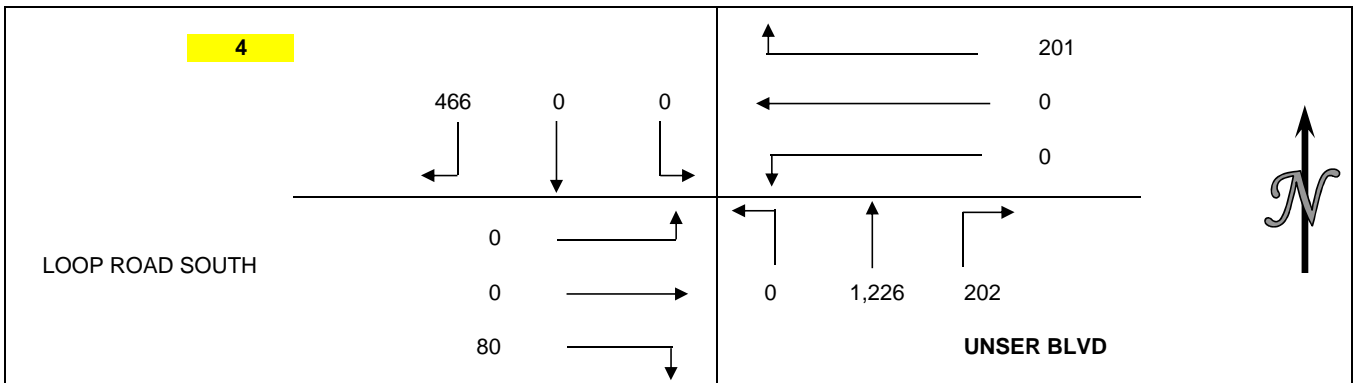
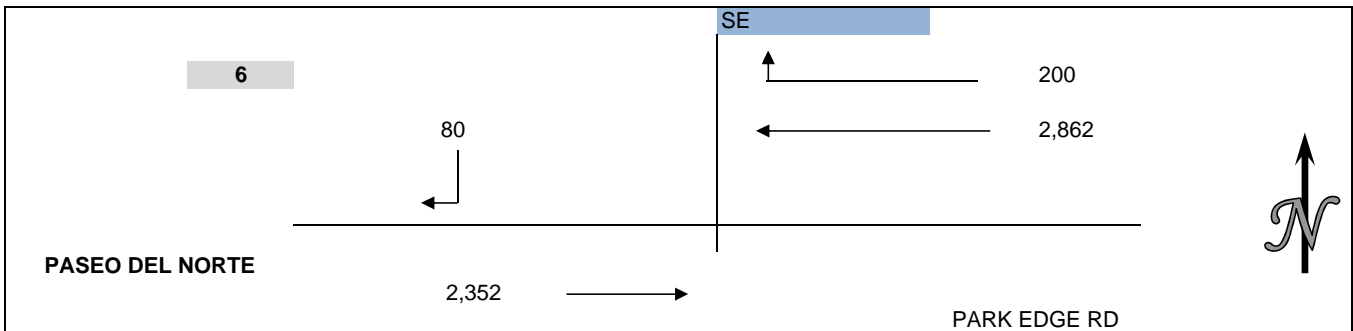
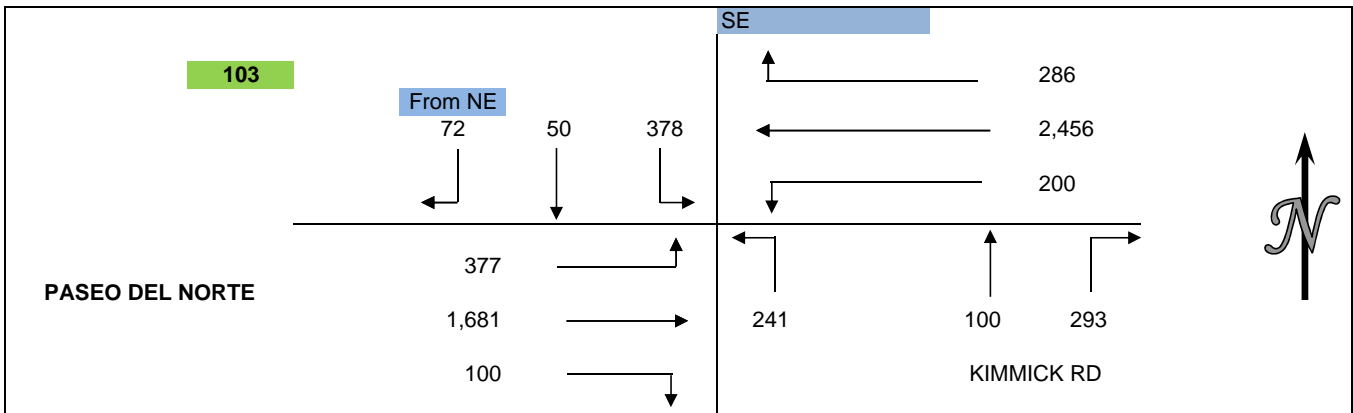
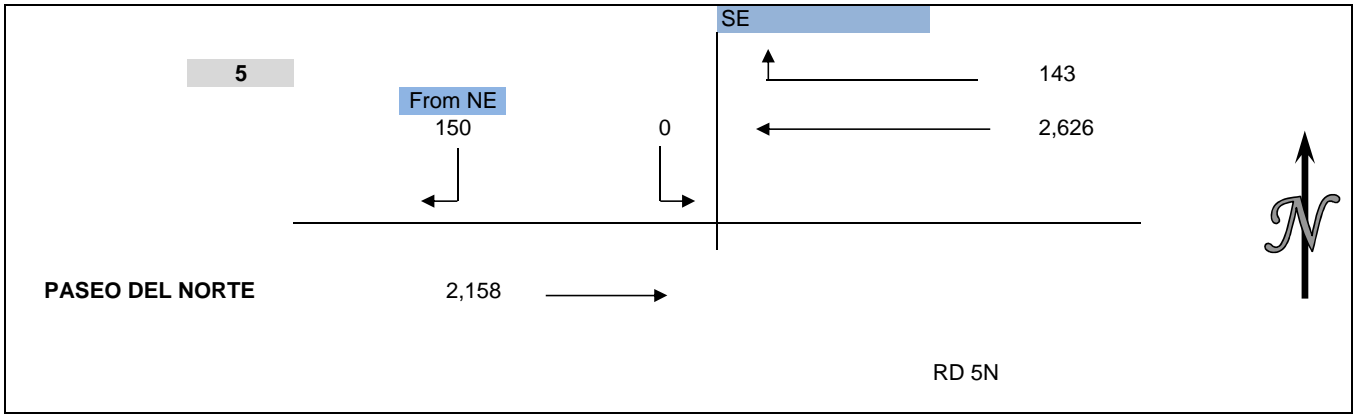

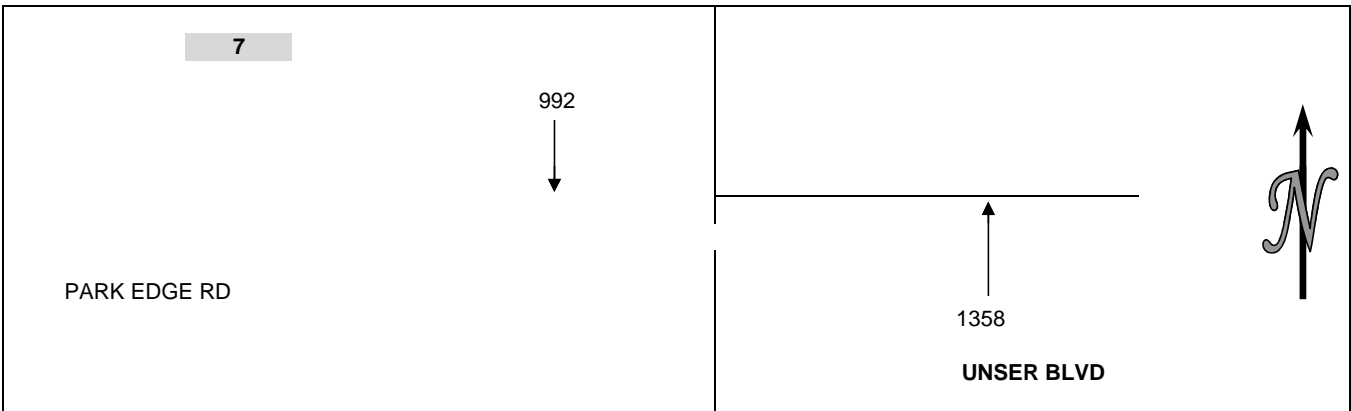
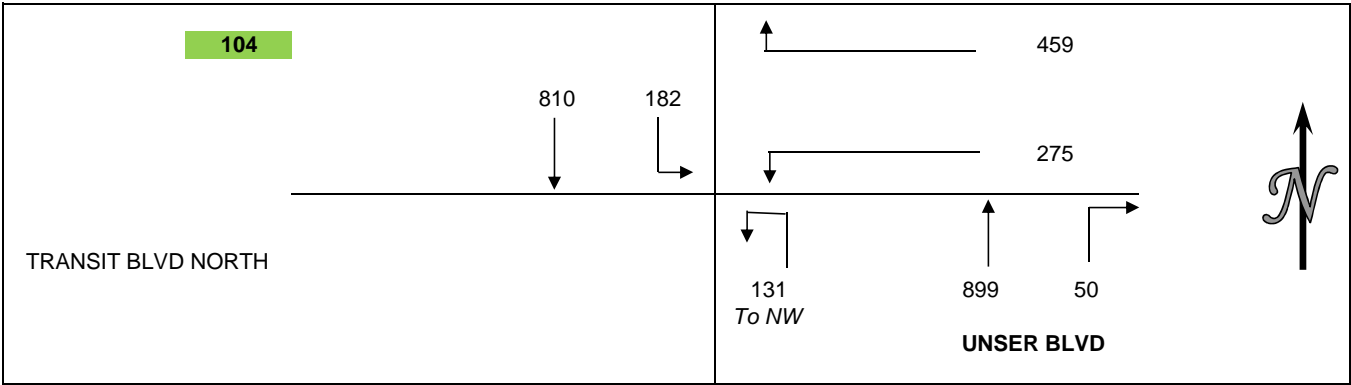
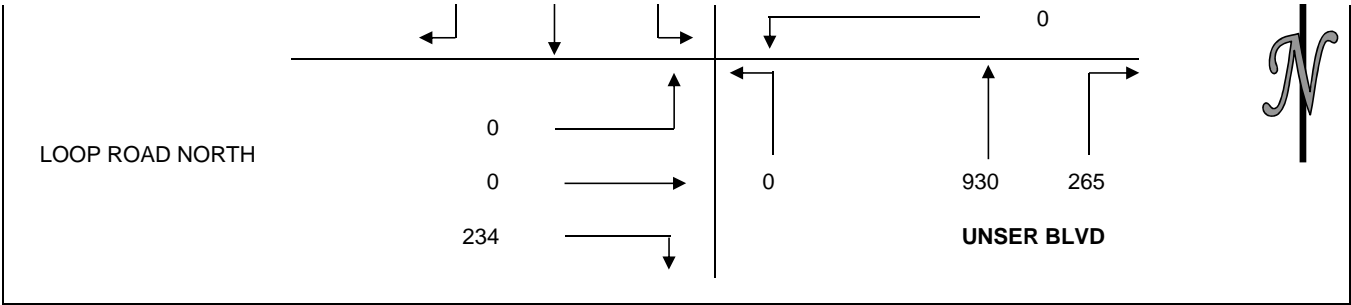

Time/Space Diagrams – Scheme B (1/2 mile spacing by Policy)

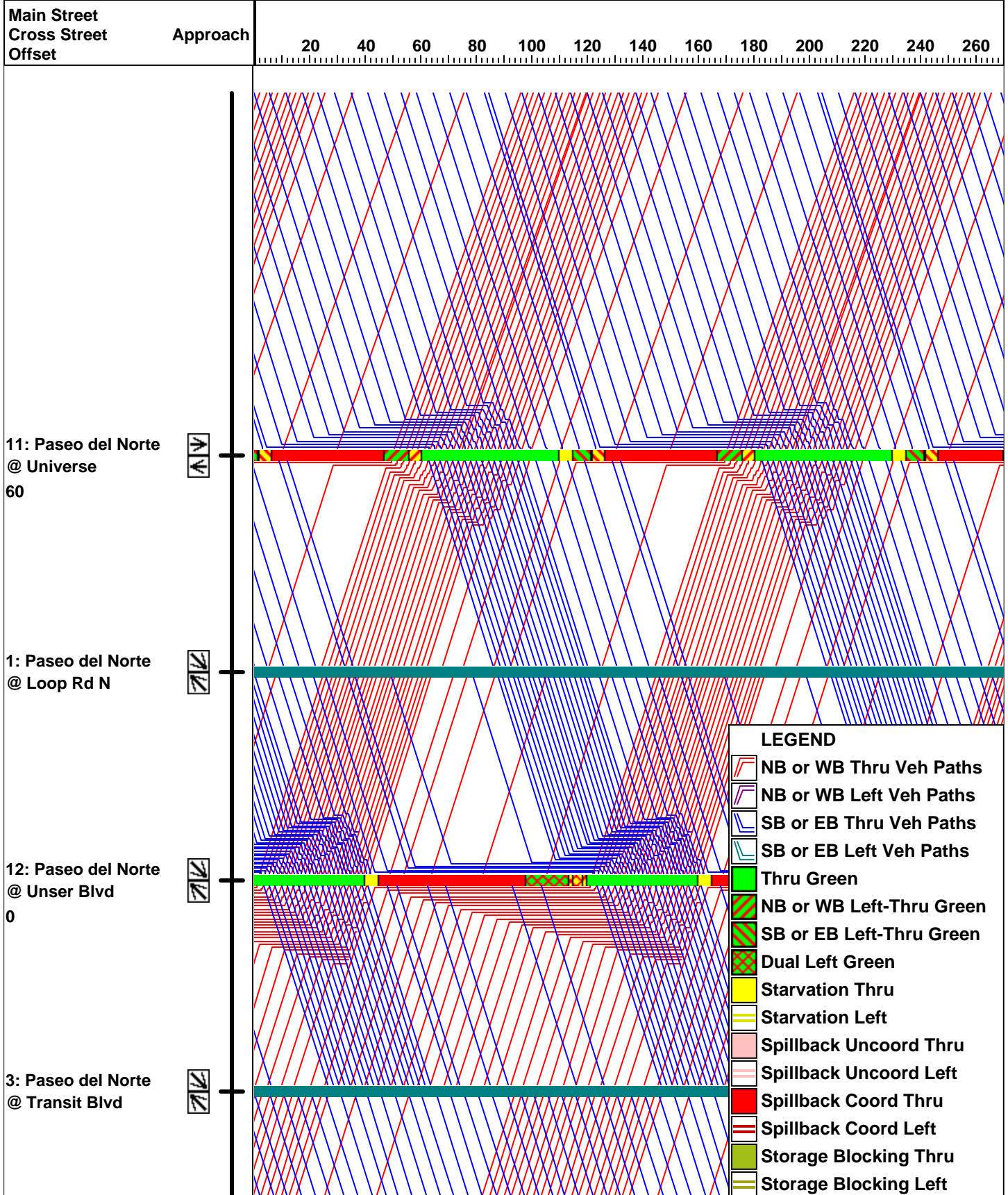

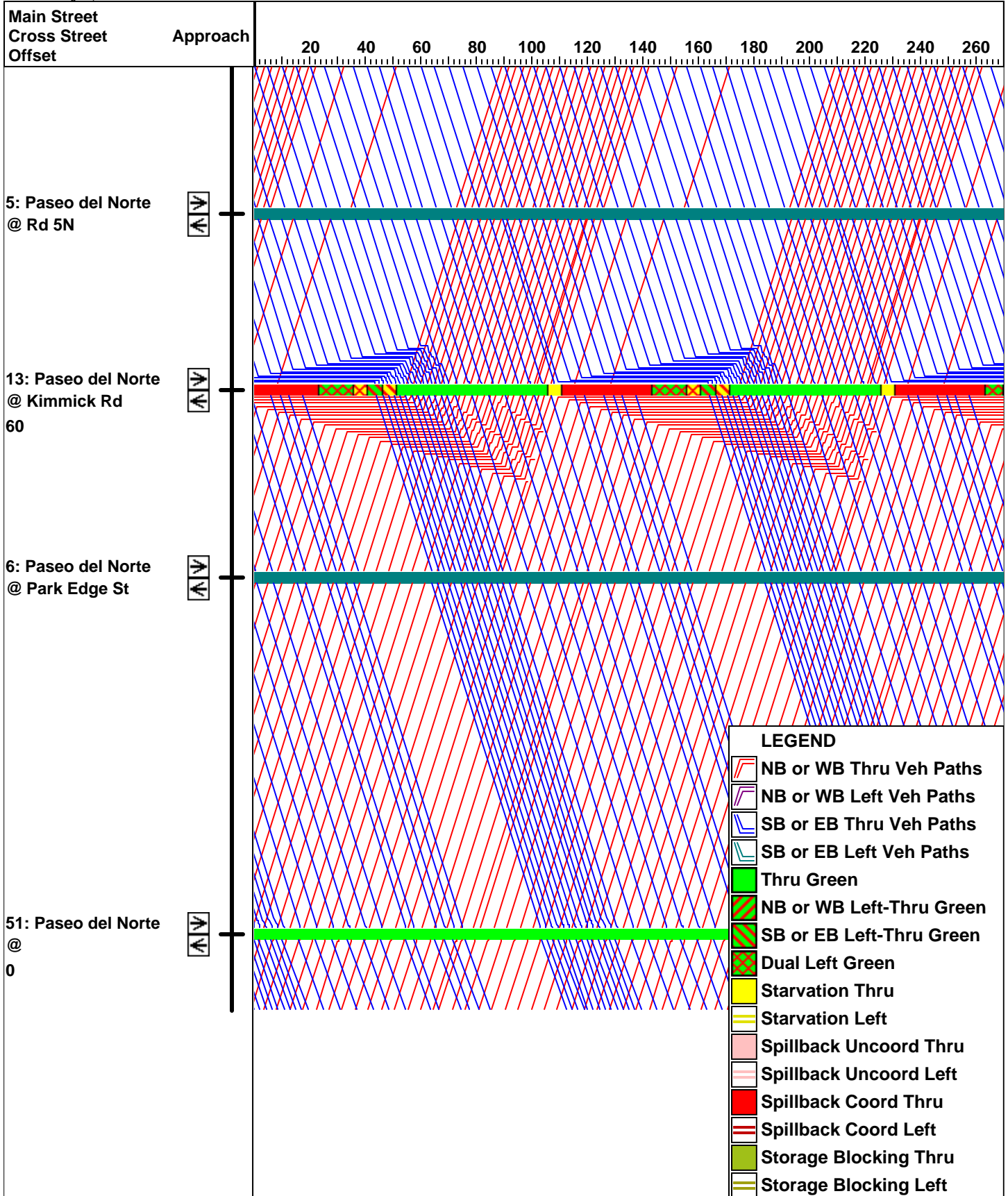

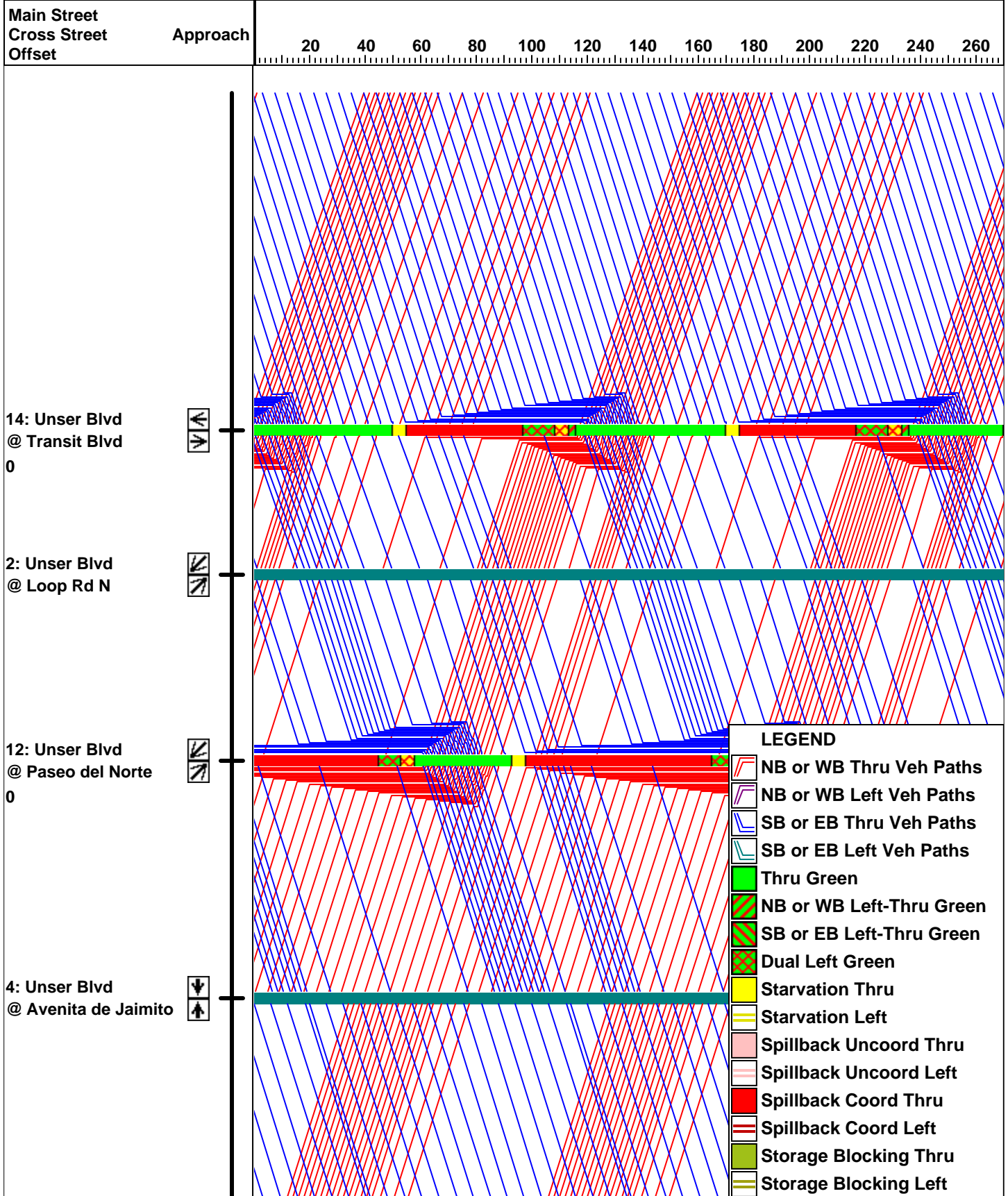

Time/Space Diagrams – Scheme D (City Spacing Request)

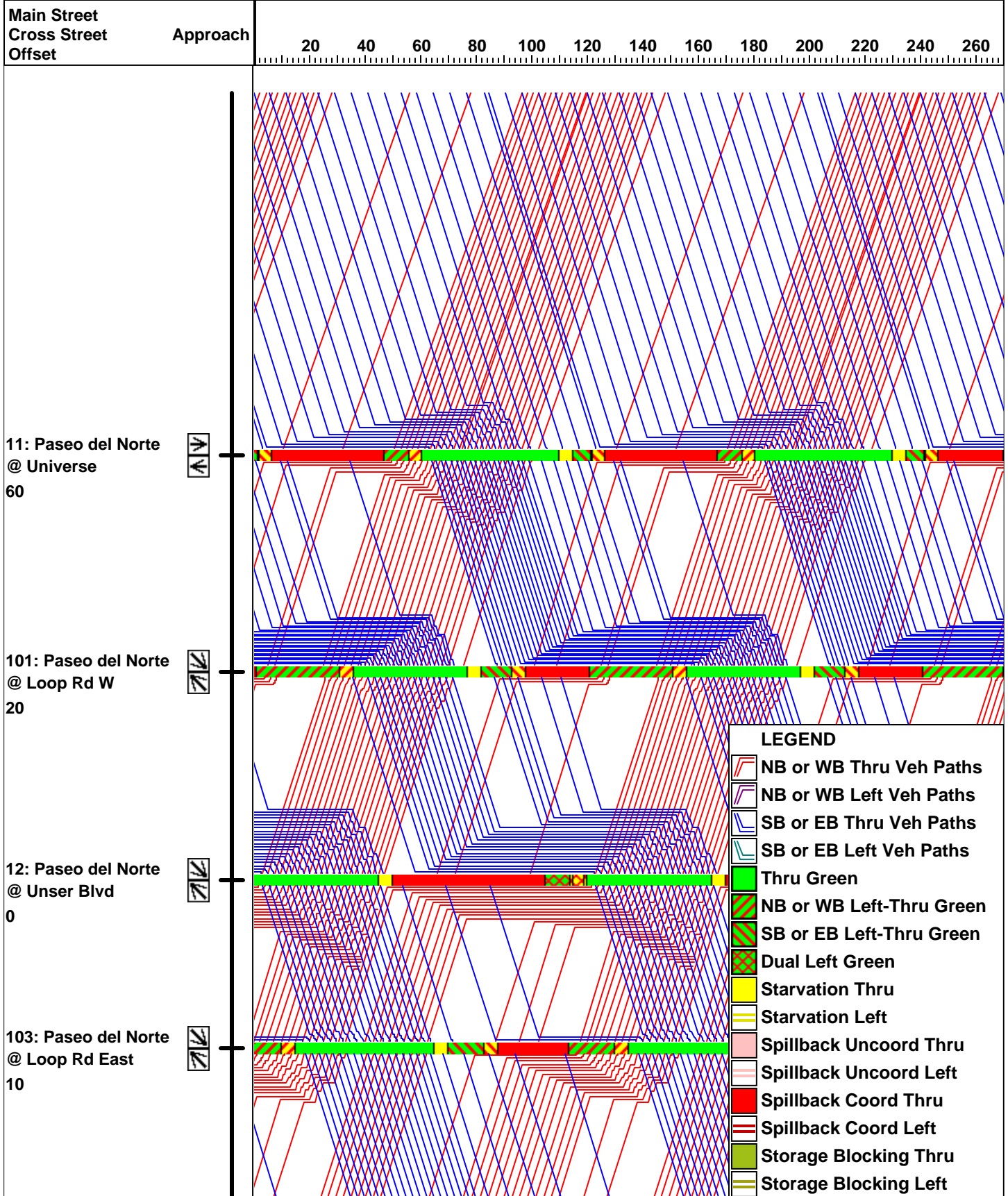

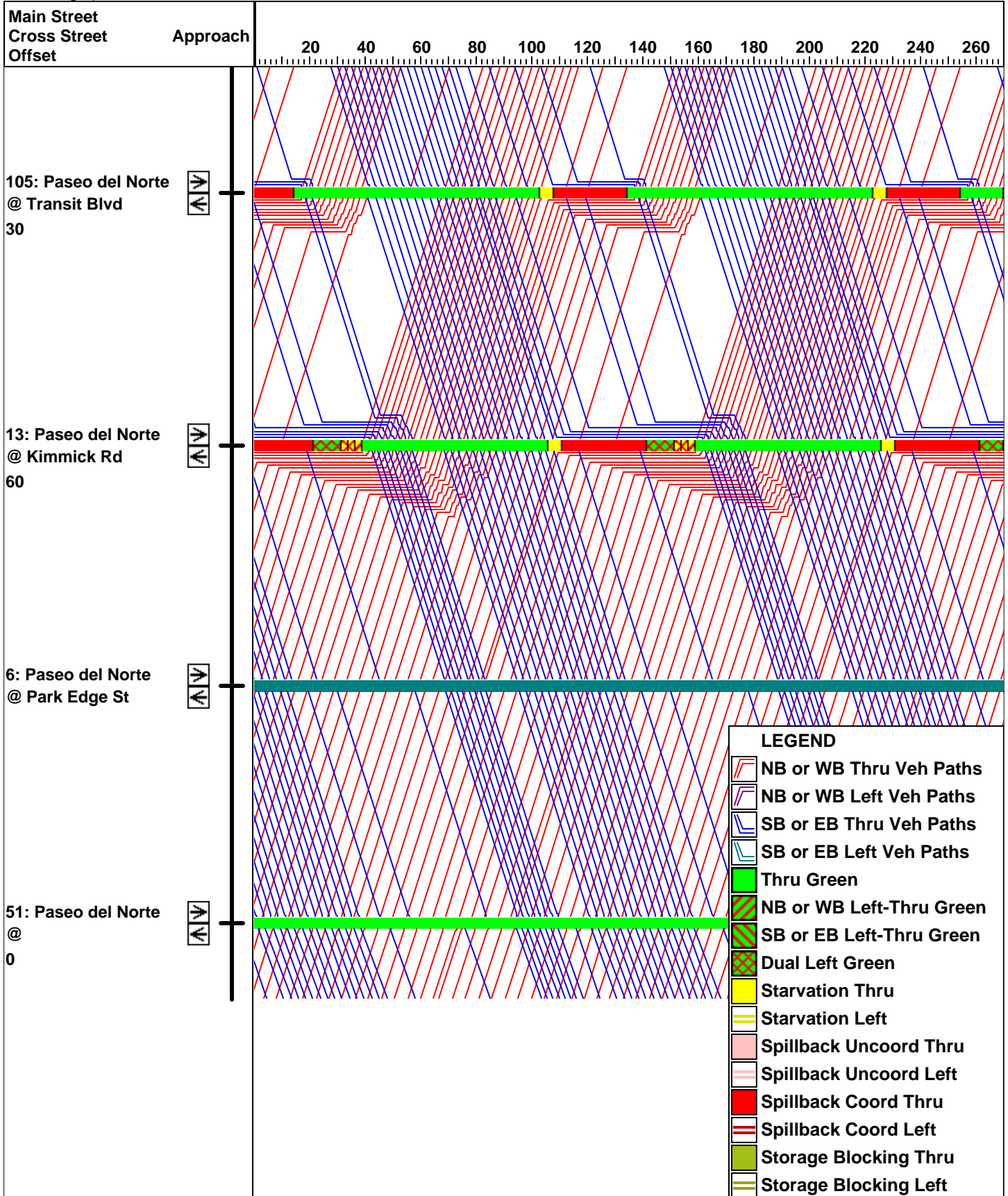

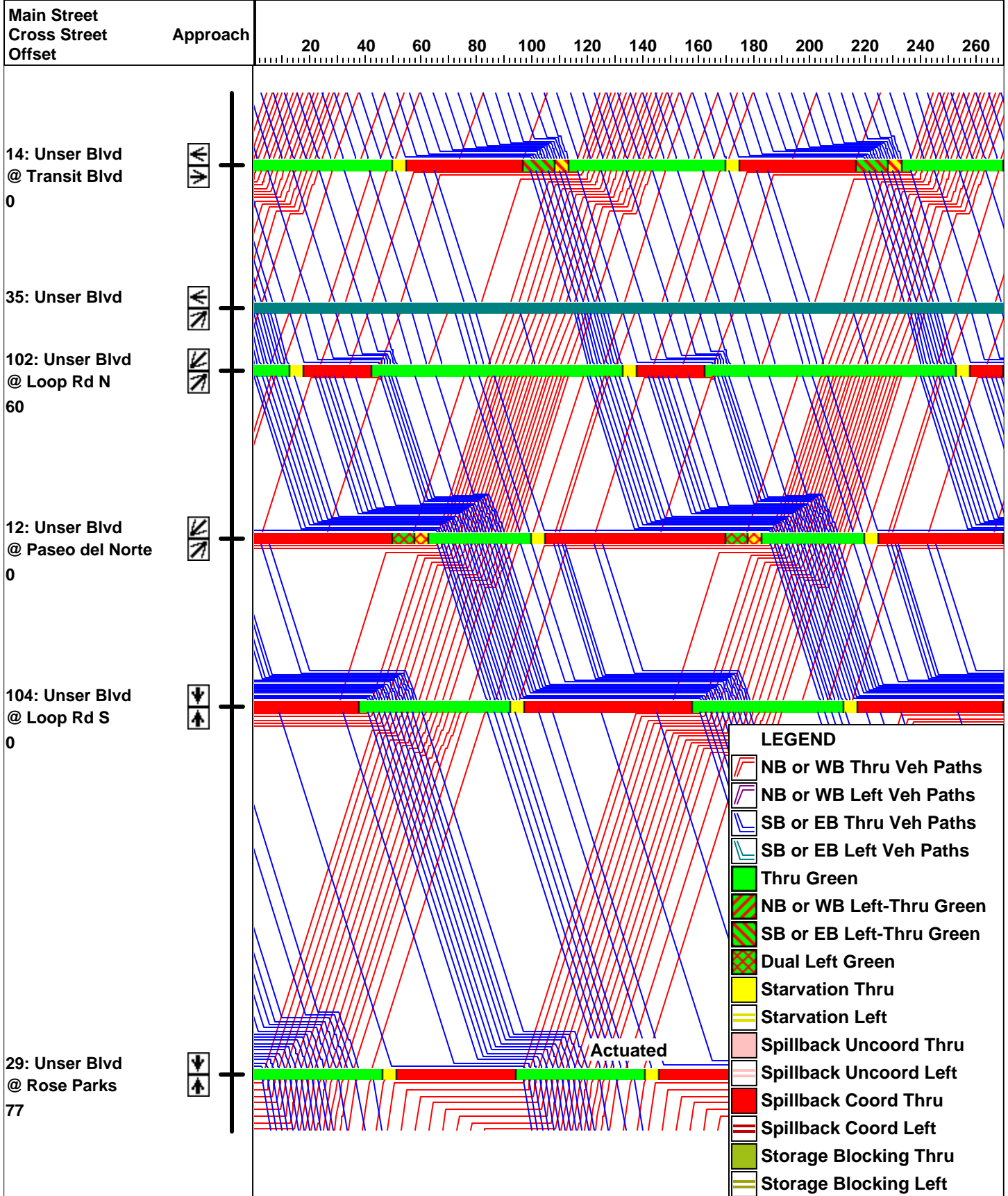

This Page Left Intentionally Blank

Appendix D

Private Preservation Options

APPENDIX

Appendix D. Private Preservation Options

ALTERNATIVE STRATEGIES FOR PRESERVING ROCK OUTCROPPINGS IN VOLCANO HILLS

Anita P. Miller
Assistant City Attorney

October 5, 2011

I. Transfer of Development Rights

A Transfer of Development Rights (“TDR”) strategy was considered in the 1990s in Albuquerque as a means of preserving significant natural and/or archaeological features on subdivided private land on the West Side of Albuquerque. One of the catalysts for the study was the petroglyphs which are located adjacent to already subdivided land. The Petroglyphs National Monument was becoming a reality, and the City did not want to see subdivision sprawl engulf private land near the Monument.

A Feasibility and Planning Analysis of TDRs in this context was prepared by Eric Damian Kelly, then a land use attorney and planner on contract with the City. At the time that the study was prepared, there was neither a state statute nor an Albuquerque ordinance governing TDRs. In 2003, NMSA 1978, §5-8-43 was adopted by the Legislature to provide guidance to counties and municipalities in regulating transfer of development rights.

- A. The purpose of this section is to
 - (1) clarify an application of existing authority;
 - (2) provide guidelines for counties and municipalities to regulate transfer of development rights consistent with comprehensive plans;
 - (3) encourage the conservation of ecological, agricultural and historical land; and
 - (4) require public notification of transfers of development rights.
- B. A municipality or county may, by ordinance, provide for voluntary transfer of all, or partial development rights from one parcel of land to another parcel of land.
- C. The ordinance shall identify on a zoning map areas from which development rights may be transferred and areas to which development rights may be transferred.
- D. The ordinance shall provide for:
 - (1) the voluntary transfer of a development right from one parcel of land to increase the intensity of development of another parcel of land;
 - (2) joint powers agreements, if applicable, for administration of transfers of development rights across jurisdictional boundaries;
 - (3) the method of transfer of development rights, including methods of determining the accounting for the rights transferred;

Appendix D. Private Preservation Options

- (4) the reasonable rules to effect and control transfers and ensure compliance with the provisions of the ordinance; and
 - (5) public notification to the areas to which development rights may be transferred.
- E. Transference of a development right shall be in writing and executed by the owner of the parcel from which the development right is being transferred and acknowledged by the transferor. A development right shall not be subject to condemnation.
- F. As used in the section, “development right” means the rights permitted on a lot, parcel or area of land under a zoning ordinance or local law respecting permissible use, area, density or height of improvements executed thereon, and development rights may be calculated and allocated in accordance with density or height limitations or any criteria that will effectively quantify a development right in a reasonable and uniform manner.
- G. Nothing in this section shall be construed to authorize a municipality or a county to impair existing property rights.

Neither Albuquerque nor Bernalillo County has adopted TDR ordinances. It should be noted that in the *Feasibility and Planning Analysis*, Eric Kelly determined that New Mexico municipalities and counties could adopt TDR programs without a statute or local ordinance, based on already adopted planning and zoning statutes and ordinances.

“Transferable development rights” are rights to develop property that are valued based on existing zoning, or based on market potential of the property as developed. The TDR process is usually used to preserve historic property, archaeological sites, and open space; to preserve agricultural land from development; or to create incentives for high-density development in another area of a municipality.

Kelly sees “cluster zoning” as a simple example of TDR. In cluster zoning, a landowner may develop a part of his property at a high density, leaving the rest of the property as undeveloped open space. Since only one property is involved, cluster zoning doesn’t usually create controversy, although neighboring property owners adjacent to a receiving area which will be more dense than their properties may object based on the impact that this development might have on their neighboring property values.

Likewise, when a TDR process is applied to an undeveloped property currently in agriculture, but there also is designated land elsewhere in the jurisdiction for dense development, the process succeeds. The agricultural land is retained, and the farmer reaps the economic benefit of higher valued developed property.

TDRs often become controversial when the existing zoning in a receiving area is changed to enable development rights to be transferred into it. Therefore, TDRs work best when both the sending area and receiving area haven’t been permanently zoned or are in a “holding area,” and are designated as part of a planning process. TDRs, then, might succeed in preserving rock outcroppings in Volcano Heights if an underdeveloped receiving area for development rights transferred in order to preserve the rocks is designated in the current planning process.

APPENDIX

Appendix D. Private Preservation Options

It should be noted that a variation of TDR, “Purchase of Development Rights” (“PDR”) has successfully been implemented in Massachusetts. The state purchased development rights from farmers on land which it wished to remain in agriculture. A variation of PDR can be found in Chicago, where development rights in the Hyde Park area were purchased by the City, and placed in a “bank”. Developers could then purchase them from the “bank”, and utilize them to create more dense development in a new area which the City wanted to see densely developed.

In the context of Albuquerque, owners of land containing rock outcroppings that are designated for preservation might also transfer their development rights to redevelopment areas elsewhere in the City. Redevelopment areas recently have been rezoned for higher density mixed uses, which might make them appropriate as “receiving areas.”

Kelly mentions that a TDR program can be defeated by popular opposition when an existing zoning designation is changed to accommodate receipt of development rights. It is assumed that the original zoning served the health, safety and general welfare of the area. When the area receives development rights and thus higher densities, the justification for the lower densities of adjacent properties no longer exists, and property owners in adjacent neighborhoods believe that their property values will plummet.

When Eric Kelly prepared his study in the 1990s, his conclusion was that they wouldn’t work in Albuquerque, except when a property owner had sufficient land to “receive” higher density. In those days, even cluster development in the developed areas of the City was met with harsh opposition from adjacent and nearby neighborhood associations. Whether a TDR program, with receiving areas designated elsewhere in the City, would succeed today, given today’s growing preference for higher density development,

is open to question. Kelly suggested that conservation easements might provide a better strategy for preserving land without the City actually owning it.

II. Conservation Easements

In New Mexico, “conservation easements” are defined as “Land Use Easements,” as follows:

NMSA 1978, §47-12-1 (1991)

- H. “land use easement” means a holder’s nonpossessory interest in real property imposing any limitation or affirmative obligation the purpose of which includes retaining or protecting natural or open space values of real property, assuring the availability of real property for agricultural, forest, recreational or open space use or protecting natural resources;

At A. of the statute,

“holder” means any non-profit corporation, nonprofit association or nonprofit trust, the purposes or powers of which include retaining or protecting the natural or open space values of real property, assuring the availability of real property for agricultural, forest, recreational or open space use, protecting natural resources or maintaining production uses of real property.

Local governments qualify as “holders.” Thus the City could protect the rock outcroppings in Volcano Heights by obtaining conservation easements on areas of land containing those

Appendix D. Private Preservation Options

rock outcroppings identified as desirable to preserve. The easements are recorded, and are governed by their specific terms. Their terms could include conditions for termination, as well as other limitations if so desired. The owner of the property would continue to own the land burdened by the easement, and would be responsible for its care and maintenance, but would not be able to develop it. The New Mexico Tax Code gives tax benefits to the landowner whose property is burdened by the easement, as does the Internal Revenue Code.

The property owner could fence in the property burdened by the easement and exclude the public; it's still his private property. If a property owner is going to develop the property as a shopping center or office park, inviting the public in, he could also invite citizens to the area protected by the easement. Terminology in the drafted easement could reflect the property owner's particular responsibilities as negotiated.

Although the Open Space Division would like to see the rock outcroppings purchased outright by the City, given budgetary limitations, obtaining a conservation easement would preserve them from development, pending availability of funds for their purchase. If such funds never were available, at the very least they'd be preserved.

It should be noted that Santa Fe County, as a result of two successful bond issues, was able to purchase land in the Galisteo Basin which contained archaeological sites. When it realized that there was additional land which also had archaeological value, and didn't have funding to purchase it as well, it utilized a conservation easement to protect it from development. A third bond issue provided sufficient funds for purchase of the land, and the easement was terminated. Thus Albuquerque could "tie up" the rock outcroppings pending obtaining funding for purchase of the sites. If preservation is the ultimate goal, lack of public access is a small price to pay.

Conclusion

If there are areas in Volcano Heights where TDRs would "work," either on the property where rocks are to be preserved or another property within the Plan area or in a specific zone where mixed use zoning and density are encouraged, existing incentives, such as increased density on the receiving site might be utilized to "reward" a property owner for transferring development rights. Certainly neighborhood associations would oppose the creation of receiving areas on Albuquerque's east side, although they might be acceptable on large redevelopment sites that might encourage high density development.

Conservation easements are easier to administer and create than TDRs. Considering that the Open Space Division prefers acquisition of property which it has designated as open space, but cannot now afford to purchase, conservation easements could preserve the designated property until funding is available to purchase it. On October 4th Albuquerque citizens voted down one of the Mayor's proposals for bond issues, reflecting public opposition to two public projects. In the current economic climate, it's likely that bond issues for purchase of open space might also be voted down. Conservation easements at least provide a method for preserving designated open space when funding isn't available to purchase it.

APPENDIX

Appendix D. Private Preservation Options

Conservation Easement for Rock Outcropping (Sample)

This Deed of Conservation Easement is granted on the day of ____ by ____ concerning the address of ____ to the City of Albuquerque for the purpose of forever conserving the cultural values of said property.

Recitals:

Significance:

The property contains special cultural significance to Pueblo people, including several nearby tribal nations. This land consists of open space containing various rock outcroppings scattered throughout. The preservation of these outcroppings shall be preserved pursuant to the NM Cultural Properties Preservation Easement Act, NMSA 1978, Sections 47-12A-1 through 47-12A-6. This act aids the landowner who wishes to voluntarily donate a conservation easement intended to restrict the use of this specified parcel so as to maintain in perpetuity the significant cultural and/or geological aspects of this land. Conserving the property is consistent with and important to the environment, culture, and economy of the surrounding area because the development of the property would jeopardize the cultural significance of the area to native people. These sites provide Pueblo people with spiritual areas to hold sacred rituals and ceremonies that have held great cultural significance for countless generations. It is important to hold these areas open to future generations of interested parties to keep the spiritual significance of the area alive.

Qualifications:

The City of Albuquerque is a qualified “holder” as described by NMSA 1978, Section 47-12A-2 and an eligible holder pursuant to the Land Conservation Incentives Act NMSA 1978, Sections 75-9-1 to 75-9-6 (2003).

Intent of Conveyance:

The land owner intends to make a charitable gift of the development interest conveyed by this deed for the purpose of assuring that under the holder’s perpetual oversight, the conservation values will be maintained forever and that any misuse of the property inconsistent with the conservation values will be corrected or prevented. The intent of this conveyance is to permit all other uses of the land not inconsistent with the conservation values as determined by the City of Albuquerque in its sole discretion that are not expressly prohibited in this deed. Nothing in this deed is intended to compel the property holder to use the property in any way other than maintaining protection and conservation values. Conveyance of this deed will not adversely affect the property owner’s property rights to develop the remainder of the property not covered by the conservation easement.

Appendix D. Private Preservation Options

Agreement:

Now therefore, in consideration of the mutual promises and covenants contained herein, the landowner voluntarily grants and conveys the land in trust to the City of Albuquerque, and the City of Albuquerque voluntarily accepts a perpetual “land use easement” over the property herein described as subject to the easement as defined by NMSA 1978, Section 47-12A-2B of the Cultural Properties Preservation Easement Act, which is also a “qualified real property interest” as defined by the C.F.R. 170(h)(2)(c), the conveyance of which is a “charitable contribution” as defined by C.F.R. 170(h).

Property Rights Retained by Owner:

Landowner reserves to himself/herself, and to his/her personal representatives, heirs successors, and assigns, all rights not expressly prohibited or limited by this easement, including all ownership rights of the Property, the right to include or exclude others, the right to sell or otherwise transfer ownership, and the right to mortgage the Property so long as the Mortgage is subordinated to this Deed.

General Uses of the Property: The landowner shall not perform nor knowingly allow others to perform acts that are inconsistent with the conservation or preservation purposes enumerated by this deed. The City of Albuquerque and the landowner acknowledge that any uses of the property or improvements of the property enumerated in this deed are consistent with the Conservation purposes. The landowner agrees that any other use of the land that is inconsistent with the law imposed on the Property is not protected by this deed.

Various Specific Uses:

- A. Subdivisions: The landowner and the City of Albuquerque agree that the property must be sold or transferred as a single unit and that any further subdivision of the Property is prohibited, unless approved by the City of Albuquerque, in its sole discretion. Any adjustments to the lot lines must be approved by the City of Albuquerque. If the property is transferred or sold, the landowner must provide to the City the address and name of the grantee.
- B. Construction: Any existing structure on the Property can be repaired, maintained, or replaced in its current location, but construction of new structures on the Property is prohibited unless at least 30 days prior to undertaking any construction, and prior to applying for a building permit for such construction, the landowner shall notify the City of Albuquerque in writing and provide the City of Albuquerque with the opportunity to review the plans for such construction for compliance with the terms of this deed. The City has the power to deny any such development that does not meet the terms of this deed.
- C. Water Rights: The voluntary separation of water rights from the Property is hereby prohibited, except as provided herein. The landowner shall take all prudent measures to ensure that forfeiture or abandonment do not occur for the Property, including maintaining timely payments, beneficial use and participation in conservation programs. If for any reason the landowner cannot beneficially use the water rights on the Property, the rights can be transferred to the City of Albuquerque for purposes of conservation or elsewhere as long as it is consistent with the conservation purposes of this easement. If transferred elsewhere, the landowner must receive written consent by the City of Albuquerque to lease or transfer the rights.

APPENDIX

Appendix D. Private Preservation Options

- D. Agriculture: All agricultural practices should be conducted in a sustainable manner. This includes ranching, farming and other agricultural practices. Agricultural practices shall use stewardship and management practices generally consistent with the standards of the U.S. Natural Resources Conservation Service or other commonly accepted sound management practices approved by the City to meet the conservation purpose of this deed.
- E. Timber: The cutting of any timber from on the Property is strictly prohibited except for fire management, to control insects or disease, to prevent personal injury and property damage, to maintain the character and nature of the existing natural habitat, and/or to prevent encroachment into agricultural fields and pastures.
- F. Utilities: The construction of new utilities on the property is prohibited without the prior written approval of the City of Albuquerque. This includes underground utilities.
- G. Roads: The construction of new roads shall be prohibited from the Property. If for some reason there is a specific need for a road, the landowner may present the City of Albuquerque with plans at least 30 days prior to receiving any permits or beginning any actual construction and must receive written consent from the City of Albuquerque to proceed.
- H. Off-road Vehicle Use: The use of any motorized vehicle is prohibited on the property except for the purposes of maintenance, conservation, agriculture, or emergency access.
- I. Impervious Surfaces: The construction of any permanent, impervious surface such as pavement or asphalt is prohibited except for those approved pursuant to paragraph G of this deed.
- J. Mining: The mining of gravel, rock, sand soil and other minerals is prohibited as consistent with the conservation values proposed in this deed.
- K. Refuse: The dumping, storing, or accumulation of any form of refuse is strictly prohibited from the property. Should any refuse be found on the property it is the landowner's duty to remove it. This prohibition does not apply to any form of composting as long as it is done in a manner consistent with the Conservation values expressed in this deed.
- L. Hazardous Materials: The storage, release, or treatment of hazardous chemicals on, from, or under the property is prohibited. For the purposes of this deed, any "Hazardous material" shall be any hazardous or toxic, material or waste considered hazardous according to any state, federal, or local laws.
- M. Commercial Activity:
 - a. Generally: Any commercial activity including producing, buying, selling or trading of goods or services shall be prohibited with the exceptions of recreational or home activities described below.
 - b. Commercial Recreational Activities: Use of the property other than "de minimis" uses as described in the Code of Federal Regulations (C.F.R.) 2031(c)(8)(B) are prohibited.
 - c. Commercial Home Activities: This deed does not prohibit home commercial activities legally permitted within the home by local zoning laws, as long as they are consistent with the conservation values in this deed.

Appendix D. Private Preservation Options

- N. Recreation: Only low-impact recreational activities are permitted, such as rock study, wildlife viewing, hiking, biking, horse-back riding, snowshoeing, or cross country skiing not inconsistent with the conservation values of this deed. Recreational facilities may only be constructed in accordance with the restrictions pursuant to section B of this Deed. The use of motorized vehicles for recreational purposes is prohibited pursuant to section H of this deed.
- O. Public Access: This deed is not intended to allow public access to the property, and the landowner maintains his/her property right to exclude any trespassers, as well as his/her right to include any public access he/she sees fit in accordance with the conservation values expressed in this deed. The City of Albuquerque maintains no obligation to take any actions to prevent trespassers on the property.
- P. Signs: The use of signs shall be prohibited other than those warning trespassers of private land, signs that explain it is in the care of the City of Albuquerque, for sale signs, or any notice or postings required by law. The signs shall not exceed two by two feet, be made of reflective material, or be artificially illuminated.

Duration of the Deed: This deed shall last with the title of the land in perpetuity, and every provision of the deed shall likewise apply to any heirs, assigns, successors, executors, administrators, and all other successors. The transfer of title shall excuse the grantor of the obligations of the provisions of this deed except those for which he/she is liable before the transfer of title. The City of Albuquerque maintains the right to review the provisions of the deed and shall do so every five years and shall be at liberty to cancel or transfer their position as a holder for this easement.

Responsibilities of Landowner: Other than as specified herein, this deed is not intended to impose any legal or other responsibility on the City of Albuquerque, or in any way to affect any obligation of the landowner as owner of the property. Unless otherwise specified below, nothing in this Deed shall require the landowner to take any action to restore the condition of the property after any Act of God or other event over which landowner had no control. The landowner shall continue to be solely responsible, and the City of Albuquerque shall have no obligation for the upkeep and maintenance of the property. The landowner acknowledges that nothing in this Deed relieves the landowner of any obligation or restriction on the use of the Property imposed by law. Among other things, this shall apply to:

- a. Taxes: The landowner is solely responsible for the payment of all taxes and assessments levied against the property. If for any reason the City of Albuquerque is forced to pay any taxes or assessments on its interest in the Property, the landowner shall reimburse the City of Albuquerque for the full amount, and such payment shall constitute a lien on the property.
- b. Upkeep and Maintenance: The landowner shall be solely responsible for the upkeep and maintenance of the property.
- c. Liability and Indemnification: The landowner shall be solely responsible for any liability arising from or related to the property, including injury or damage to any person or organization related directly or indirectly to the action or omission by the landowner. If for any reason the City of Albuquerque has to pay for any damages, the landowner shall indemnify and reimburse the City for the amount as well as any attorney fees resulting from the costs of defending itself. The landowner shall not have to reimburse the City of Albuquerque if the City is to be the proximate cause of the injury.

APPENDIX

Appendix D. Private Preservation Options

- d. Insurance: The landowner warrants that the City of Albuquerque is and will continue to be an additional insured on the landowner's liability insurance policy covering the property. The landowner shall provide certificates of such insurance to the City of Albuquerque within thirty days after the date of recordation of this deed and subsequently, upon the City of Albuquerque's written request. Landowner shall advise the City of Albuquerque at least thirty days in advance of cancellation of any insurance policy.

Landowner Warranties:

- a. Title warranty: The landowner warrants that he/she has good and sufficient title to the property, and that there are no liens on, leases to, pending or threatened litigation relating to the Property, or other interests in the property, including verbal agreements, that have not been disclosed to the City of Albuquerque in writing. The landowner hereby promises to defend the property and the easement against all claims from persons claiming by, through, or under the landowner. In the event any cloud of title exists, the landowner shall be responsible for procuring a release of claim signed by the relevant parties.

- a. *If the landowner has a mortgage on property:* The landowner warrants that he/she has good and sufficient title to the property, that the lien on the property held by _____ dated _____, has been subordinated to this deed, and that there are no other liens on, leases to, or other interests in the property that have not been disclosed to the City of Albuquerque in writing. The landowner hereby promises to defend the property and the easement against all claims from persons claiming by, through, or under the landowner.

- b. Environmental Warranty: The landowner warrants that he/she has no knowledge of a release or threatened release of hazardous material on the property. The landowner will indemnify, defend, and hold harmless the City of Albuquerque against any litigation, claims, costs, damages, losses, or any other expenses of any kind arising from the release of hazardous material on the property. Nothing in this deed is intended to convey any sort of day-to-day managerial right to the City of Albuquerque from the landowner. The owner of the property retains the right to manage the property, subject to restrictions in this easement and any federal, state, or local laws, regulations or ordinances governing environmental conditions on the property.

Inspection: The City of Albuquerque maintains the right to inspect the property as long as the City gives the landowner reasonable, advance notice. The City of Albuquerque will typically inspect the property annually but reserves the right to inspect it any time as long as the City gives the owner proper notice. If the City of Albuquerque has reason to believe that there is an ongoing, imminent, or threatened violation of the provisions of this deed, the City of Albuquerque will make good faith efforts to contact the landowner but may enter the Property in an effort to avert this emergency without needing to give prior notice to the landowner.

Enforcement: The City of Albuquerque has all the rights, remedies, and power to enforce the terms of this deed against the landowner that are provided by law or in equity including actions prior to court action such as mediation or arbitration. Except when an ongoing or imminent violation could irreversibly diminish or impair the conservation values described in this easement, the City of Albuquerque will give written notice of the violation to the landowner and he/she will have thirty days before the City of Albuquerque will take

Appendix D. Private Preservation Options

legal action. If a court with jurisdiction determines that a violation may exist or has occurred, the City of Albuquerque may obtain an injunction to stop the violation, temporarily or permanently, and to restore the Property to its condition prior to the violation. In any case where a court finds that a violation has occurred, the landowner shall reimburse the City of Albuquerque for all its expenses incurred in stopping and correcting the violation, including reasonable attorneys' fees and court costs. If the court finds no violation, the landowner and the City of Albuquerque shall each bear individual expenses and attorneys' fees. The landowner and the City of Albuquerque agree that this allocation of expenses is appropriate.

Transfer of Easement: The City of Albuquerque maintains the right to transfer this easement to another qualified holder according to the subsections below:

- a. Voluntary: if the City of Albuquerque ever wants to voluntarily transfer the easement, the City will give notice sixty days before the transfer takes place in order to allow the landowner to voice any preferences as to who the new holder shall be. The City of Albuquerque shall take due consideration of this suggestions and shall choose accordingly. This easement can only be transferred to an organization that is qualified as a holder under NMSA 1978, Section 47-12A-2B and that agrees to uphold the terms of this Deed.
- b. Involuntary: If the City of Albuquerque ceases to qualify under C.F.R. 170(h)(3), or NMSA 1978, Section 47-12A-1 through 47-12A-6, a court with proper jurisdiction shall dictate the transfer or this deed to another qualified organization that agrees to uphold the terms of this Deed.

Amendment of Easement: The City of Albuquerque and the landowner agree that there may be situations in which the need to amend various provisions of the deed may arise and agree that in order to amend any provisions, both the City of Albuquerque and the landowner must agree in writing to any such changes. Any written agreement, executed by both the City of Albuquerque and the landowner, to amend this deed must be filed with the County Clerk's office in which this deed is filed.

Termination of the Easement:

- a. Condemnation: The City of Albuquerque shall be informed by the property owner of any condemnation action undertaken by the federal or state government within 10 days of initiation of that action. If all or a part of the property is taken for public use (or sold to a public authority under threat of condemnation), and the easement is terminated in whole or in part, then the City of Albuquerque shall be entitled to a percentage of the condemnation award or sale proceeds (including any increase in value caused by improvements made after the date of this Deed) equal to the ratio, as of the date of this Deed, of the appraised value of the Easement to the unrestricted fair market value of the property.
- b. Changed Conditions: The landowner and the City of Albuquerque recognize that in some cases all conservation value of the property may be irreversibly lost due to changes not caused by any particular party. The City of Albuquerque and the landowner retain the right to jointly request a court with jurisdiction to terminate all or a portion of this deed and order the sale of the property. The irreversible loss of all conservation value is the only grounds upon which to terminate this deed. Upon the sale of the land, the City of Albuquerque shall be entitled to a percentage of the sale proceeds (including any increase in value caused by improvements made after the date of this

APPENDIX

Appendix D. Private Preservation Options

deed) equal to the ratio, as of the date of this Deed, of the appraised value of the Easement to the unrestricted fair market value of the property.

- c. **Other Termination Conditions:** This Deed constitutes a property right conveyed to the City of Albuquerque that shall immediately vest once this deed has been signed by the County Clerk and filed in the official records of Bernalillo County and shall give the City of Albuquerque the rights to the fair market value of the apportioned land, which will be stipulated to be between the landowner and the City of Albuquerque. Any funds the City of Albuquerque receives from the termination of this easement shall be used in a way consistent with the conservation values expressed in this agreement.
- d. **Economic Termination Conditions:** In no circumstances will the economic devaluation of the property or economic infeasibility of this easement be seen as grounds appropriate to terminate this easement.

Approvals: Before doing anything that requires the approval of the City of Albuquerque, the landowner agrees to request the approval from the City of Albuquerque in writing. The City of Albuquerque shall be given forty-five days from the day of receipt to respond in writing to the written request of the landowner.

Notices: Any written notices required by this deed shall be hand delivered or sent through the US mail services. The current addresses as of the date of creating this deed for the landowner and the City of Albuquerque are as follows:

To the Landowner:

To the City of Albuquerque:

All parties must be notified of any changes of addresses. Also the address of the Property shall be a suitable address for the City of Albuquerque to address any notices they are required to send to the landowner.

Transfer of the Property: The landowner retains the right to transfer or sell his property rights at any time as long as this deed remains attached to the property rights in the conveyance and that he/she gives the City of Albuquerque written notice sixty days before said transfer or sale. The City of Albuquerque retains the right to deny the sale of the property associated with this deed, and the landowner must receive written permission from the City of Albuquerque before selling this land. Purchasers of the property subject to the conservation easement are bound by its terms, as are heirs of the original property owner in the event of its death. If the property is foreclosed, then both the foreclosing institution and purchaser in a foreclosure sale are also subject to the terms of this provision.

Subsequent Mortgages: This deed in no way impairs the property owner from receiving additional mortgages or liens against the property as long as these liens are subordinate to the provisions of this Deed.

Waiver: No portion of this deed shall be waived without the written consent of both parties.

Incorporation: Any recitals set forth at the beginning of this deed as well as any attached exhibits referenced herein shall be incorporated to this deed by this reference.

Interpretation: Any interpretations of the contents of this deed shall be governed by the laws of the State of New Mexico. Furthermore any interpretations of the content of this deed shall be done so without regard to the authorship of the contents, but rather with regards to maximizing the proposed conservational and protectoral values associated with this deed.

No Third Party Beneficiaries: This deed was entered into by the landowner and the City of Albuquerque and was intended for their sole benefit. No rights or responsibilities shall be created in any third party pursuant to this Deed.

Appendix D. Private Preservation Options

Counterparts: This deed can be broken into two or more parts, each of which shall be executed by both parties, and each part will be considered an original document, but in the aggregate this deed shall still be considered a single agreement.

Severability: If any provision of this deed is found to be illegal, this illegal content shall not affect any other provision of this deed, and the deed shall still remain legally enforceable.

Integration: This deed sets forth all provisions of the agreements between the landowner and the City of Albuquerque and supersedes any prior and subsequent negotiations, understandings, documents, or agreements relating to this deed.

Recording: the City of Albuquerque shall record this deed in a timely fashion in the official records of Bernalillo County, New Mexico. The City of Albuquerque shall also re-record this deed anytime there are changes to any provision or other information contained in this deed in order to preserve the rights and protections of this deed.

Acceptance: The City of Albuquerque has accepted the easement conveyed by this deed and the rights and responsibilities contained herein. The City of Albuquerque agrees to have and to hold this Deed of Conservation Easement unto the City of Albuquerque forever in perpetuity.

Reviewed by:

(City Attorney)

APPENDIX

Appendix D. Private Preservation Options

Signatures and Acknowledgements:

The landowner:

(Print name)

County of _____)

_____) SS
State of _____)

The foregoing Deed was acknowledged before me on the day
of _____ by _____

(Notary Public Seal)

My Commission Expires: _____

The City of Albuquerque,
A New Mexico Municipality

(Print Name of Representative)

County of _____)

_____) SS
State of _____)

The foregoing Deed was acknowledged before me on the day
of _____ by _____, representative of
the City of Albuquerque

(Notary Public Seal)

My commission expires: _____

Appendix E

Fiscal Impact Analysis

This Page Left Intentionally Blank

Volcano Heights Sector Development Plan: Fiscal Impact Analysis

August 2013



Prepared For: City of Albuquerque



A GATEWAYPLANNING and Balfour Beatty Company

Table of Contents

- I. Introduction.....1
- II. Understanding and Assumptions1
- III. Analysis Assumptions1
- IV. Development Scenario Value5
- V. Fiscal Impact.....7
- VI. Current and Projected Property Value7
- VII. Implementation and Conclusion.....7

This study was prepared to gauge the fiscal impact of potential development as envisioned by the Volcano Heights Sector Development Plan. There are several real challenges to development in this 570-acre greenfield area. Going from a completely undeveloped area – with no utilities, roads, drainage, or water service available – to a high-density, high-intensity Major Activity Center represents a steep investment and a significant obstacle to initial investment and ultimate build out success. A series of infrastructure improvements is necessary to catalyze development and enable private investment to succeed in implementing the development vision for a walkable district. As the only development of its type on Albuquerque’s West Side, there are also significant opportunities for profit and benefits to the expanded marketability for employment west of the Rio Grande.

Because Volcano Heights is based on a new development pattern with a mix of uses supported by a multimodal transportation network, there is an extra value created by such development above and beyond what could typically be expected from traditional suburban development patterns. This extra value could be leveraged through public-private partnerships to successfully create a walkable job center and live/work district on Albuquerque’s West Side.

Understandings and Assumptions

The Volcano Heights Sector Development Plan encompasses approximately 570 acres in northwest Albuquerque. Currently, Volcano Heights is entirely undeveloped, with a total land value of \$1,299,365, according to the Bernalillo County Assessor Office. Typically, a city’s ability to shape development is limited to either upgrading infrastructure (e.g.

upgrading a road to a complete street with multimodal streetscape amenities, providing enhanced transit service, or providing other “horizontal” infrastructure improvements) or investing in catalytic projects (e.g. constructing a new civic development, redeveloping a historic property, or making other investments to “vertical” development).

In Volcano Heights, the City is in a unique position to guide development in this sector from the beginning. A strategic investment in a project that can act as a catalyst for private investment would be paid back both financially from the increased revenue from property taxes and gross receipts taxes as well as physically from laying the foundation for placemaking and high-quality development on the City’s West Side.

This report compares the potential value of Volcano Heights’ mixed-use development strategy to a traditional suburban single-use development pattern. The two development scenarios have been modeled using a proprietary development projection tool based on proven national growth patterns. Development has been projected over 15 years based on conservative estimates, market trends, inflation, and entitlements associated with each scenario.

As seen in **Table 1**, under the typical suburban model, the Plan area would build out over a 15-year period, with an approximate total development value of \$650 Million. Redevelopment could be expected in commercial areas on a 12- to 15-year cycle. The majority of land would be tied up with suburban residential development, which would either significantly limit or even eliminate the potential for future redevelopment.

With the proposed mixed-use entitlement scenario, a greater amount of land would be developed as large parcels. Because this initial development will set the pattern for an urban, walkable district, as the market changes or new uses become desirable, new development or redevelopment can easily be added or upgraded, which in turn further strengthens the sense of place and increases the level of activity and viability for all existing uses. The idea is not to create a new downtown, but to instead balance density

Please Continue to Page 4



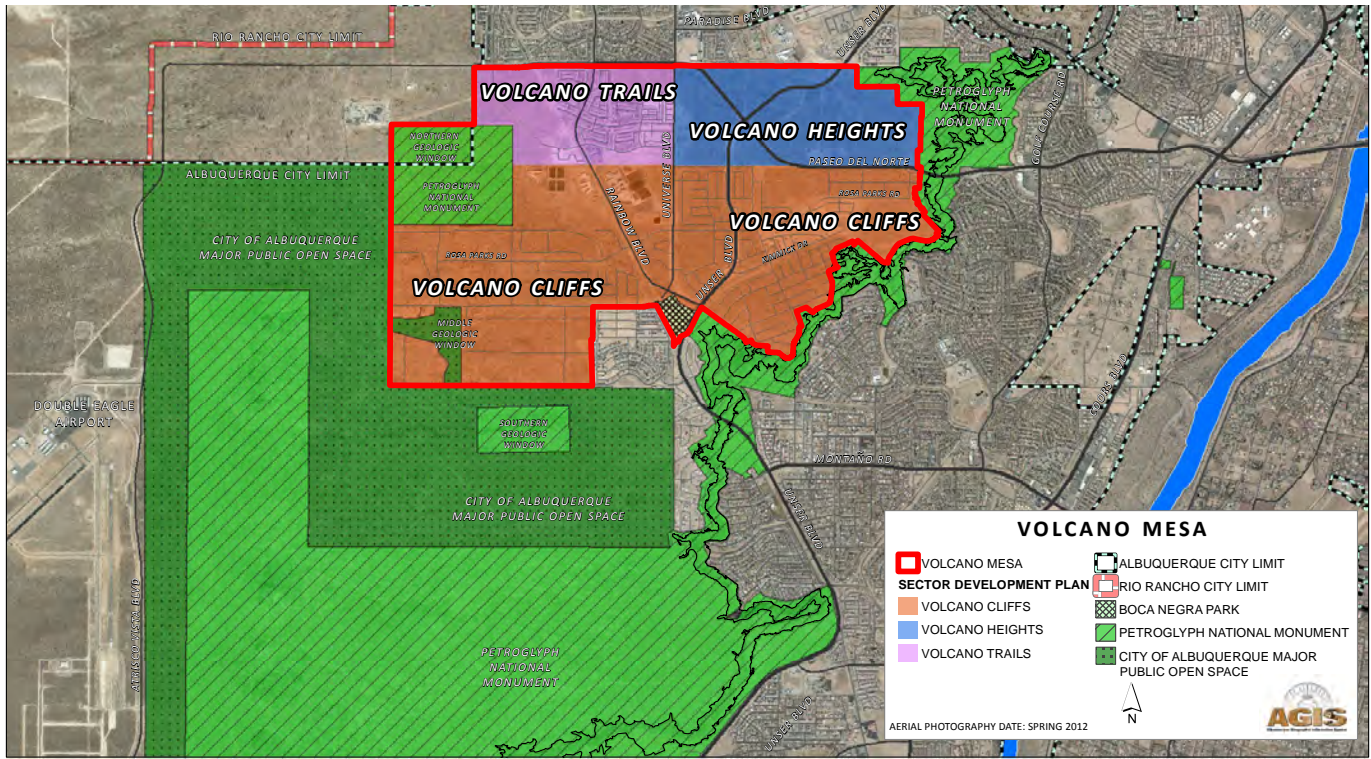

Figure 1: Volcano Mesa Sector Development Areas

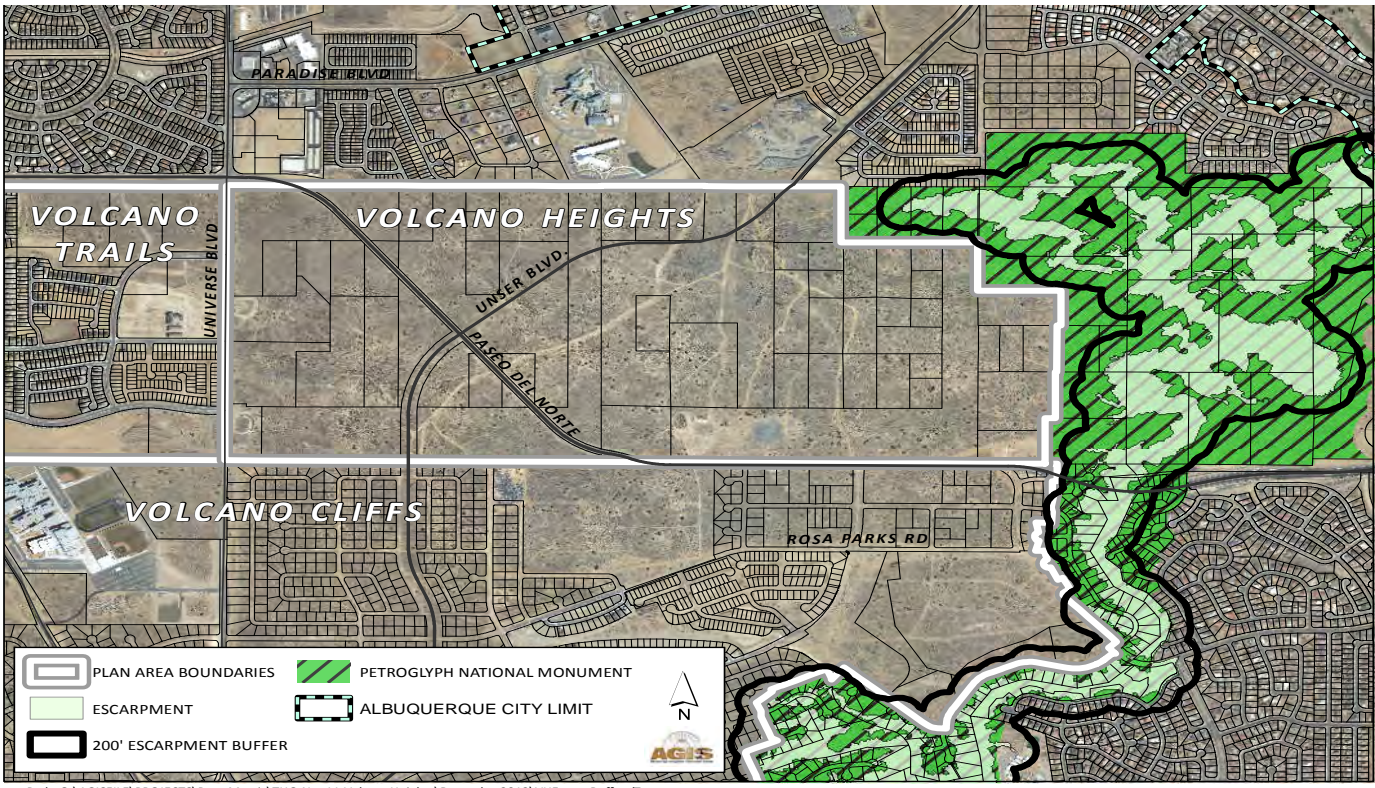

Figure 2: Volcano Heights Sector Area

Land Use Type	SQFT	Units	Value
Single Family Residential	-	2,102	\$420,376,000
Townhouse Residential	-	379	\$65,592,750
Multifamily	-	759	\$82,698,300
Suburban Commercial	918,027	-	\$82,622,430
Total	918,027	3,240	\$648,289,480

Table 1: Potential of Existing Suburban Entitlement Value at 15-Years without Inflation

Land Use Type	SQFT	Units	Value
Single Family Residential	-	364	\$72,800,000
Townhouse Residential	-	291	\$48,015,000
Multifamily	-	4,114	\$448,426,000
Hotel	53,600	-	\$7,772,000
Office	1,180,135	-	\$135,715,525
Regional Retail	326,700	-	\$29,403,000
Specialty Retail	322,198	-	\$33,186,394
Local Retail	170,600	-	\$15,865,800
Total	2,053,233	4,769	\$791,183,719

Table 2: Potential Mixed-Use Entitlement Total Value at 15-Years without Inflation



15-year Development Cycle		
	Existing Suburban	Mixed-Use Place
Net New Residents	8,067	10,664
Net New Jobs	1,469	4,323

Table 3: Projected New Growth

Assumptions Table		
Residential Occupancy:	92%	
Commercial Occupancy:	85%	
Average MF Unit Size	1000	Sqft
Average SF Unit Size	2000	Sqft
Hotel Room Size:	300	Sqft
Avg. Residents Per MF Unit	2.4	People
Avg. Residents Per SF Unit	2.8	People
Inflation Rate	2%	per year

Table 4: Analysis Assumptions

and height to achieve a critical mass of activity, creating a place that people want to visit or live, given their own preferences or desires. Instead of competing or clashing with existing development as it might in a traditional suburban context, new developments or redevelopment add to the success of the area as a whole and to each business and residential project.

At the end of the assumed 15-year buildout cycle, the mixed-use entitlement has already surpassed the value of the traditional suburban entitlement and has the potential to grow or stay stable over time, as shown in **Table 2**. Given that a critical mass has been created through placemaking efforts, the potential for redevelopment is stronger,

and the cost of services per user is lower than the traditional model.

Table 3 demonstrates estimated population and employment impact for the two development scenarios.

Table 4 shows the assumptions used in the calculations. Base data were derived from a number of sources, including Bernalillo County and the City of Albuquerque.

Development Scenario Value

The two development scenarios project two very different built environments that have diverging

Please Continue to Page 6

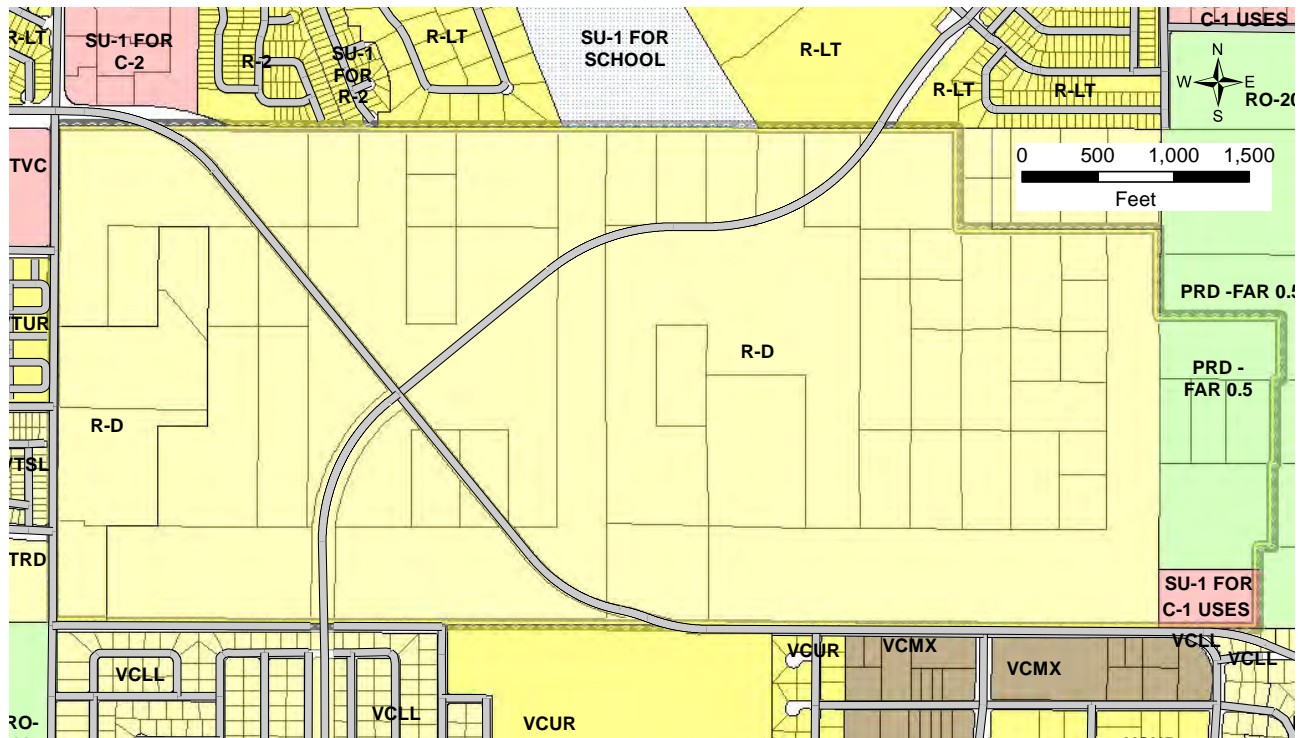

Figure 3: Pre-existing Zoning

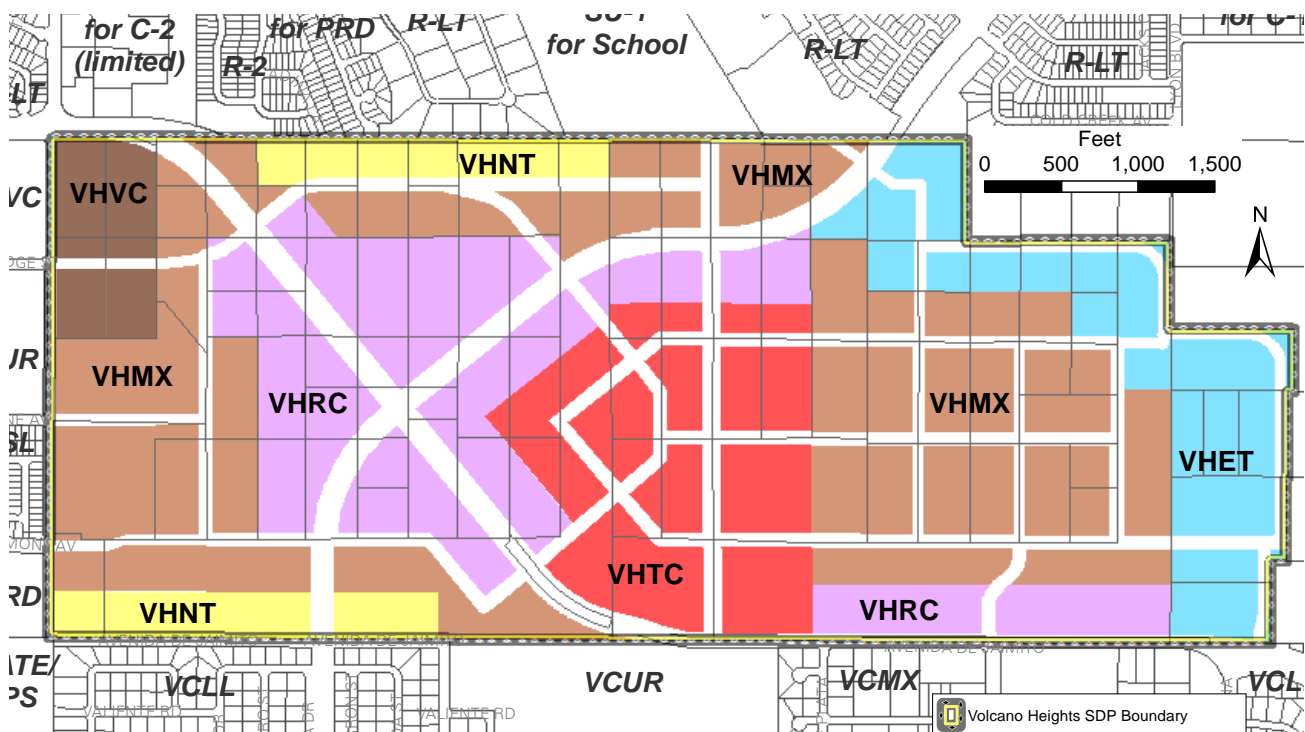
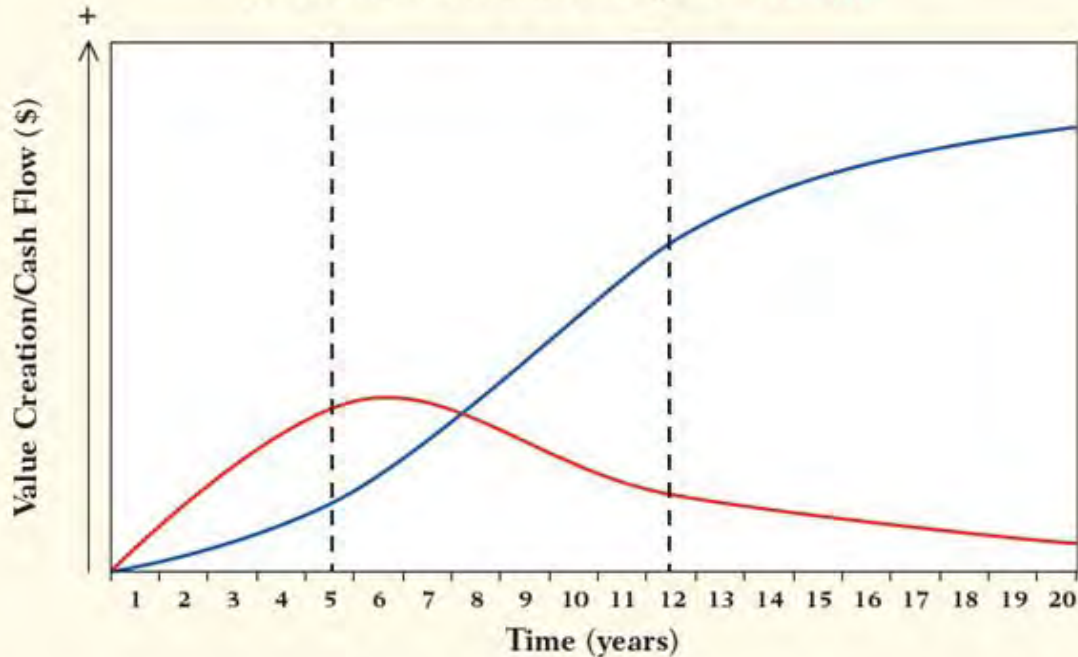

Figure 4: Adopted Zoning Map



Financial Characteristics of Downtowns with Critical Mass (Blue) versus Suburban Development (Red)



Source: Christopher B. Leinberger, Arcadia Land Co. and Robert Charles Lesser & Co.

Figure 5: Value of Development Types

values over time. **Figures 6 and 7** assume the average development values over the course of 15 years. The suburban entitlement model is assumed to have a build out with equal investment amounts over 15 years. This projection amount reflects the average accounting for fluctuations over two to three real estate cycles. The value reaches a peak after one real estate cycle, after which new investment moves to another greenfield development opportunity. After that point, values decline dramatically in commercial areas and more slowly in residential areas.

In contrast, the mixed-use entitlement model depicts growth over 15 years in a pattern that is typical of place-based environments, where growth builds slowly to a tipping point. Momentum is gained once the “place” is established and provides the foundation for future value, as shown in **Figure 5**. Because entitlements in Volcano

Heights allow a mix of uses, existing development can be repurposed to meet changing market opportunities. Form-based codes allow evolution from one real estate cycle to the next, allowing additional investment within a developed area available through a streamlined administrative approval process. These form-based codes ensure the level of quality from one project to the next, protecting property values and offering predictability for investors and neighbors. The adaptability of the mixed-use development model removes the potential ceiling on value and minimizes the likelihood of disinvestment and decline over time.

Current and Projected Development Value

According to the Bernalillo County Tax Assessor, the current appraised value for 562 unimproved

Please Continue to Page 8

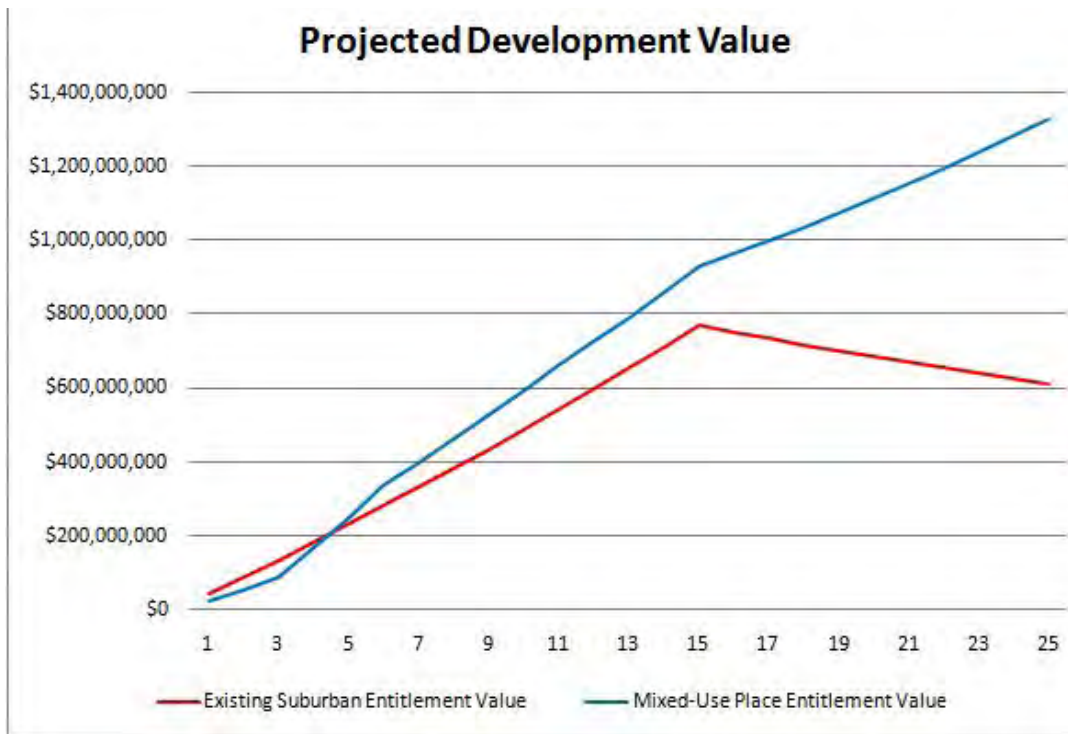

Figure 6: Property Value Comparison

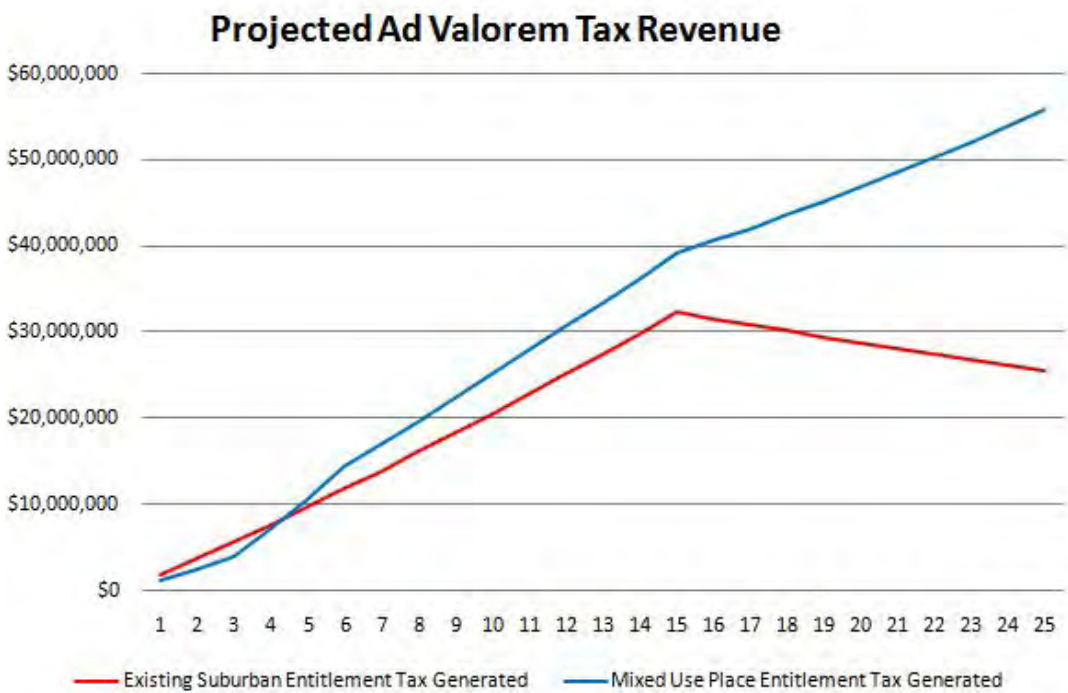

Figure 7: Ad Valorem Tax Revenue Comparison



Implementation and Conclusion

acres in Volcano Heights is \$1,299,365. After 15 years, under the suburban entitlement scenario, the value of development (i.e. projected ad valorem value) is approximately \$769 million. Under the mixed-use entitlement model, this value is approximately \$932 million, an increase of over 20%, as seen in **Figure 6**.

Current and Projected Ad Valorem Tax Revenue

Figure 7 shows the anticipated ad valorem tax revenue that will be generated per year over 25 years. Assuming no change in property tax rates, suburban entitlements provide approximately \$530 million in ad valorem tax revenue, while the mixed-use development model provides approximately \$769 million, almost a 45% increase in value. Common exemptions, such as a Homestead exemption, were not deducted from the projected Ad Valorem tax revenue estimation.

Detailed revenue projections are shown in **Table 5**.

Implementation

Once the Sector Development Plan is adopted and sets the entitlements, regulations, and policies in place to focus on placemaking and mixed-use development, various City departments and outside agencies can analyze the infrastructure needed to support the development vision. This includes the City Department of Municipal Development for roads and storm drainage infrastructure, Public Service Company of New Mexico for electric utilities, New Mexico Gas for gas utilities, the Albuquerque Bernalillo County Water Utility Authority for water and wastewater, and cable and internet service providers. Enforceable policies and regulations are needed in order to create accurate assumptions about what infrastructure will be required to support desired development patterns.

Once infrastructure costs have been estimated, the City should consider strategic investments that could best catalyze and leverage private investment. Mixed-use development is expected to

require more costly infrastructure than suburban development. Knowing the additional value of these mixed-use environments, the City can consider which portion of the additional cost makes sense to support, given the expected levels of return over and above typical suburban development. These decisions can be made on a rational basis, and the potential revenues should justify some measure of support or initial catalytic infrastructure project in Volcano Heights.

Conclusion

Cities across the United States have discovered that the high initial investment and steep drop off of value typical of the suburban development pattern leads to long-term fiscal liability that exceeds tax income over the lifecycle of development and infrastructure. Many cities are moving instead to a model of public-private partnerships that lay a foundation to create a sense of “place” in which initial investments are more than recovered by the long-term value as the area continues to produce value over time. This mixed-use model is a solution to the suburban model of short-term gain that jeopardizes long-term value.

As this report indicates, the potential for better outcomes is compelling, and the City should carefully consider how to invest in Volcano Heights’ success to reap the financial benefits, as well as the enhanced opportunities for economic development and placemaking, this model offers. This opportunity truly represents a win-win for development. The use of special districts, such as Public Improvement Districts (PIDs), Special Assessment Districts (SADs), or Tax Increment Development Districts (TIDDs) could ensure that capital improvements are focused on economic and catalytic impact, rather than simply reconstructing aging infrastructure at the end of its lifecycle. By investing in appropriate catalytic improvements, the City can be the frontrunner in investment in the future of sustainable value in Volcano Heights.

Development Analysis Tool

Volcano Heights Albuquerque

2013-2038

Revenue Projection

Period	Base	1	2	3	4	5	6	7	8	9	10	11	12	13	14	15	15-Year Total
Conventional Build																	
Existing Conditions Taxable Value	1,299,365	1,299,365	1,299,365	1,299,365	1,299,365	1,299,365	1,299,365	1,299,365	1,299,365	1,299,365	1,299,365	1,299,365	1,299,365	1,299,365	1,299,365	1,299,365	19,490,475
Conventional Build Value		43,219,299	43,219,299	43,219,299	43,219,299	43,219,299	43,219,299	43,219,299	43,219,299	43,219,299	43,219,299	43,219,299	43,219,299	43,219,299	43,219,299	43,219,299	648,289,480
Conventional Total Value		44,518,664	89,927,701	136,244,918	183,488,480	231,676,914	280,829,116	330,964,362	382,102,312	434,263,022	487,466,946	541,734,949	597,088,312	653,548,742	711,138,380	769,879,811	769,879,811
State	1,767	60,545	122,302	185,293	249,544	315,081	381,928	450,112	519,659	590,598	662,955	736,760	812,040	888,826	967,148	1,047,037	7,991,594
County	10,548	361,403	730,033	1,106,036	1,489,559	1,880,753	2,279,771	2,686,769	3,101,907	3,525,347	3,957,257	4,397,804	4,847,163	5,305,509	5,773,021	6,249,884	47,702,764
City	14,969	512,855	1,035,967	1,569,541	2,113,787	2,668,918	3,235,151	3,812,709	4,401,819	5,002,710	5,615,619	6,240,787	6,878,457	7,528,882	8,192,314	8,869,015	67,693,501
School APS	13,595	465,799	940,914	1,425,531	1,919,840	2,424,036	2,938,315	3,462,880	3,997,936	4,543,694	5,100,367	5,668,173	6,247,335	6,838,080	7,440,641	8,055,252	61,482,388
CNM	4,345	148,870	300,718	455,603	613,585	774,728	939,093	1,106,745	1,277,750	1,452,176	1,630,089	1,811,562	1,996,663	2,185,467	2,378,047	2,574,478	19,649,919
UNMH	8,316	284,919	575,537	871,967	1,174,326	1,482,732	1,797,306	2,118,172	2,445,455	2,779,283	3,119,788	3,467,104	3,821,365	4,182,712	4,551,286	4,927,231	37,607,501
AMAFCA	1,106	37,885	76,528	115,944	156,149	197,157	238,986	281,651	325,169	369,558	414,834	461,016	508,122	556,170	605,179	655,168	5,000,622
Total Tax Generated	54,646	1,872,277	3,781,999	5,729,916	7,716,792	9,743,404	11,810,549	13,919,037	16,069,695	18,263,366	20,500,910	22,783,205	25,111,146	27,485,646	29,907,636	32,378,065	247,128,289
Mixed Use Build																	
Existing Conditions Taxable Value	1,299,365	1,299,365	1,299,365	1,299,365	1,299,365	1,299,365	1,299,365	1,299,365	1,299,365	1,299,365	1,299,365	1,299,365	1,299,365	1,299,365	1,299,365	1,299,365	19,490,475
Mixed Use Build Value		24,294,267	26,508,308	33,008,308	76,037,620	76,037,620	84,351,620	53,557,354	53,557,354	53,557,354	53,557,354	53,557,354	51,343,313	51,343,313	51,343,313	51,343,313	793,397,760
Mixed Use Total Value		25,593,632	53,913,177	89,299,113	168,422,081	249,127,507	339,761,043	401,412,982	464,297,960	528,440,638	593,866,169	660,600,211	726,454,893	793,626,668	862,141,879	932,027,394	932,027,394
State	1,767	34,807	73,322	121,447	229,054	338,813	462,075	545,922	631,445	718,679	807,658	898,416	987,979	1,079,332	1,172,513	1,267,557	9,370,787
County	10,548	207,769	437,667	724,930	1,367,250	2,022,417	2,758,180	3,258,671	3,769,171	4,289,881	4,821,006	5,362,753	5,897,361	6,442,661	6,998,868	7,566,198	55,935,331
City	14,969	294,839	621,080	1,028,726	1,940,222	2,869,949	3,914,047	4,624,278	5,348,713	6,087,636	6,841,338	7,610,114	8,368,760	9,142,579	9,931,874	10,736,956	79,376,080
School APS	13,595	267,786	564,094	934,337	1,762,200	2,606,621	3,554,920	4,199,984	4,857,950	5,529,074	6,213,622	6,911,860	7,600,898	8,303,716	9,020,590	9,751,803	72,093,049
CNM	4,345	85,585	180,286	298,616	563,203	833,082	1,136,161	1,342,325	1,552,612	1,767,105	1,985,888	2,209,047	2,429,265	2,653,888	2,883,002	3,116,700	23,041,112
UNMH	8,316	163,799	345,044	571,514	1,077,901	1,594,416	2,174,471	2,569,043	2,971,507	3,382,020	3,800,743	4,227,841	4,649,311	5,079,211	5,517,708	5,964,975	44,097,822
AMAFCA	1,106	21,780	45,880	75,994	143,327	212,008	289,137	341,602	395,118	449,703	505,380	562,171	618,213	675,376	733,683	793,155	5,863,632
Total Tax Generated	54,646	1,076,366	2,267,373	3,755,564	7,083,159	10,477,306	14,288,990	16,881,824	19,526,515	22,224,099	24,975,636	27,782,202	30,551,787	33,376,763	36,258,239	39,197,344	289,777,814

Table 5: Revenue Projections

Development Analysis Tool											
Volcano Heights Albuquerque											
2013-2038											
Revenue Projection											
Period	16	17	18	19	20	21	22	23	24	25	25-Year Total
Conventional Build											
Existing Conditions Taxable Value	1,299,365	1,299,365	1,299,365	1,299,365	1,299,365	1,299,365	1,299,365	1,299,365	1,299,365	1,299,365	32,484,125
Conventional Build Value	0	0	0	0	0	0	0	0	0	0	648,289,480
Conventional Total Value	751,932,181	734,433,242	717,371,775	700,736,846	684,517,790	668,704,210	653,285,970	638,253,186	623,596,221	609,305,681	609,305,681
State	1,022,628	998,829	975,626	953,002	930,944	909,438	888,469	868,024	848,091	828,656	17,215,300
County	6,104,185	5,962,129	5,823,624	5,688,582	5,556,915	5,428,541	5,303,376	5,181,339	5,062,354	4,946,344	102,760,153
City	8,662,259	8,460,671	8,264,123	8,072,488	7,885,645	7,703,473	7,525,854	7,352,677	7,183,828	7,019,201	145,823,721
School APS	7,867,466	7,684,375	7,505,861	7,331,810	7,162,110	6,996,652	6,835,331	6,678,043	6,524,687	6,375,165	132,443,888
CNM	2,514,461	2,455,945	2,398,891	2,343,264	2,289,027	2,236,147	2,184,588	2,134,319	2,085,306	2,037,518	42,329,386
UNMH	4,812,366	4,700,373	4,591,179	4,484,716	4,380,914	4,279,707	4,181,030	4,084,820	3,991,016	3,899,556	81,013,178
AMAFCA	639,894	625,003	610,483	596,327	582,525	569,067	555,946	543,153	530,680	518,519	10,772,221
Total Tax Generated	31,623,260	30,887,324	30,169,787	29,470,189	28,788,080	28,123,024	27,474,595	26,842,376	26,225,963	25,624,960	532,357,847
Mixed Use Build											
Existing Conditions Taxable Value	1,299,365	1,299,365	1,299,365	1,299,365	1,299,365	1,299,365	1,299,365	1,299,365	1,299,365	1,299,365	32,484,125
Mixed Use Build Value	0	0	0	0	0	0	0	0	0	0	793,397,760
Mixed Use Total Value	965,947,718	1,001,055,253	1,037,391,552	1,074,999,621	1,113,923,973	1,154,210,677	1,195,907,416	1,239,063,540	1,283,730,129	1,329,960,049	1,329,960,049
State	1,313,689	1,361,435	1,410,853	1,461,999	1,514,937	1,569,727	1,626,434	1,685,126	1,745,873	1,808,746	24,869,606
County	7,841,564	8,126,567	8,421,545	8,726,847	9,042,835	9,369,882	9,708,376	10,058,718	10,421,321	10,796,616	148,449,601
City	11,127,718	11,532,157	11,950,751	12,383,996	12,832,404	13,296,507	13,776,853	14,274,012	14,788,571	15,321,140	210,660,188
School APS	10,106,711	10,474,041	10,854,228	11,247,721	11,654,987	12,076,506	12,512,779	12,964,322	13,431,668	13,915,372	191,331,384
CNM	3,230,129	3,347,529	3,469,037	3,594,799	3,724,962	3,859,681	3,999,114	4,143,428	4,292,794	4,447,386	61,149,971
UNMH	6,182,065	6,406,754	6,639,306	6,879,998	7,129,113	7,386,948	7,653,807	7,930,007	8,215,873	8,511,744	117,033,438
AMAFCA	822,022	851,898	882,820	914,825	947,949	982,233	1,017,717	1,054,443	1,092,454	1,131,796	15,561,790
Total Tax Generated	40,623,897	42,100,380	43,628,539	45,210,184	46,847,187	48,541,484	50,295,082	52,110,056	53,988,554	55,932,800	769,055,977

This Page Left Intentionally Blank



A GATEWAYPLANNING and **Balfour Beatty** Company

3100 McKinnon Street, 7th Floor
Dallas, TX 75201
o. 817.348.9500 f. 214.451.1176

www.vialtagroup.com